

Particle identification

G.Unal (CERN)

Why particle identification ?

- *Is particle X decaying to electrons or muons ? Which are the corresponding branching ratio ?*
 - Understand properties (couplings) of this particle
- *Use particle Identification to separate signal and backgrounds*
 - To search for $H \rightarrow \gamma \gamma$ at LHC identify photons in the final state
- *Use particle Identification to optimize measurement of complicated final state*
 - «particle flow» event reconstruction in collider experiments

Cross-sections in hadron collider

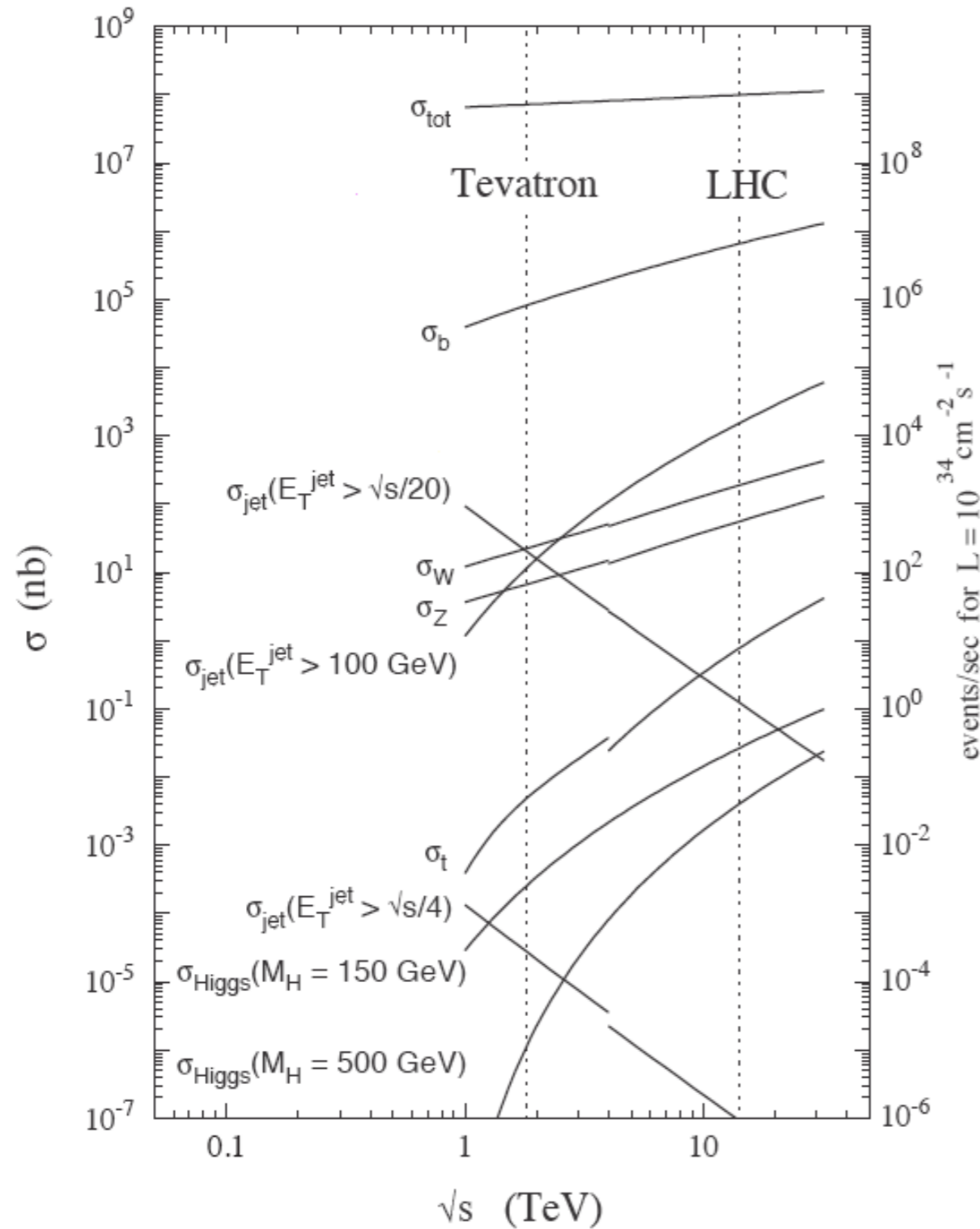

High energy leptons give access to interesting physics processes

Some of these selections have to be done in real time (trigger) to reduce data rate to an acceptable level

Example of $Z \rightarrow ee$ sample in UA2 experiment (1988-1990 data)

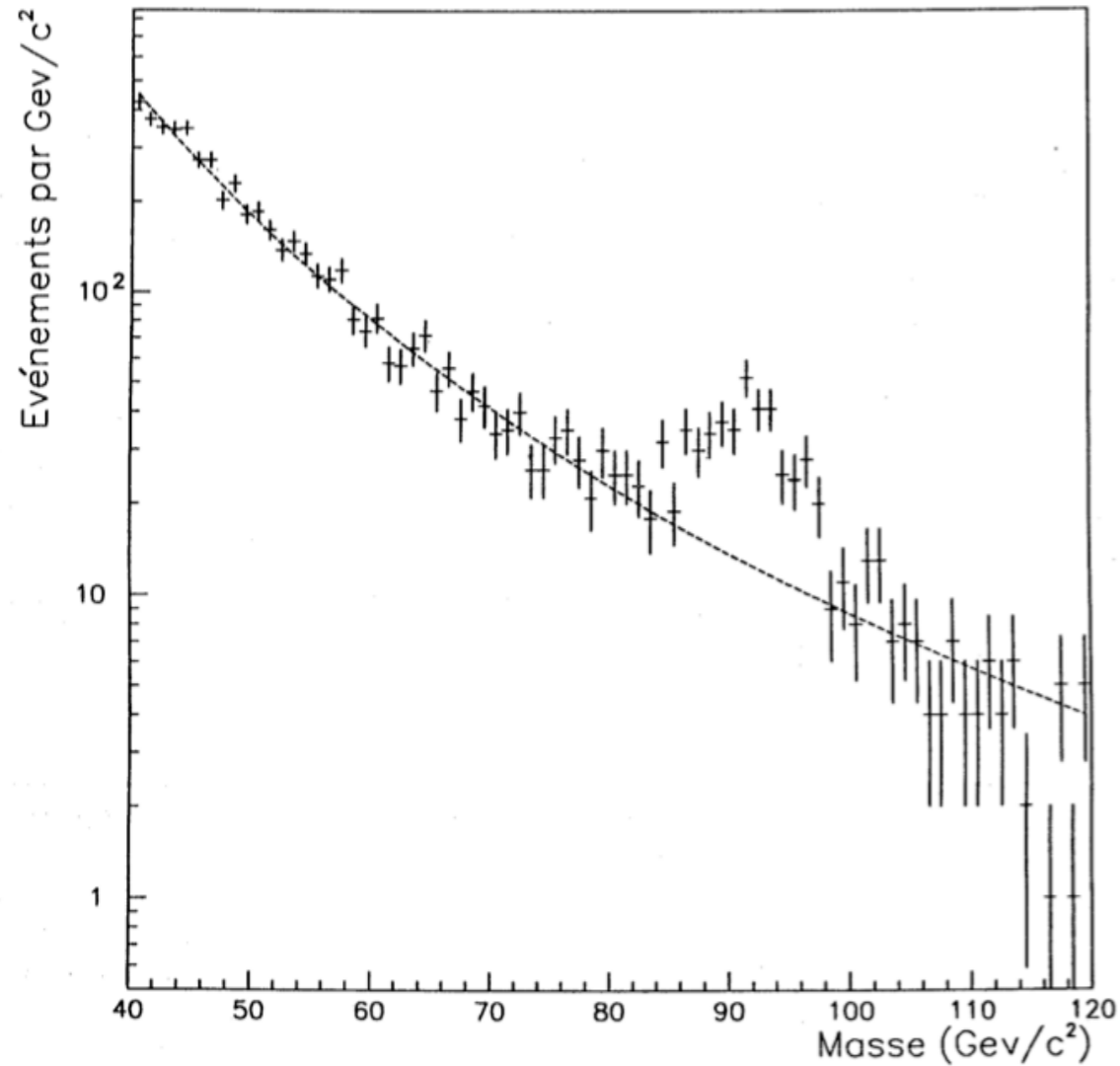

only calorimeter information
 $S/B \sim 1/1$

Adding matching to reconstructed track for electron identification

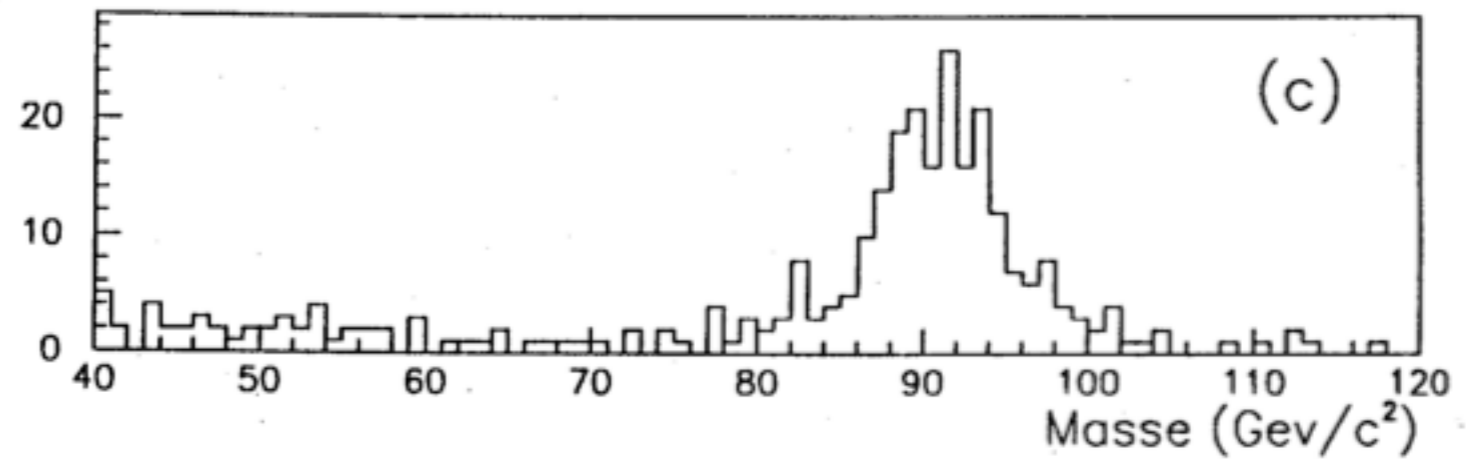

Detect Higgs boson through its decay to photons

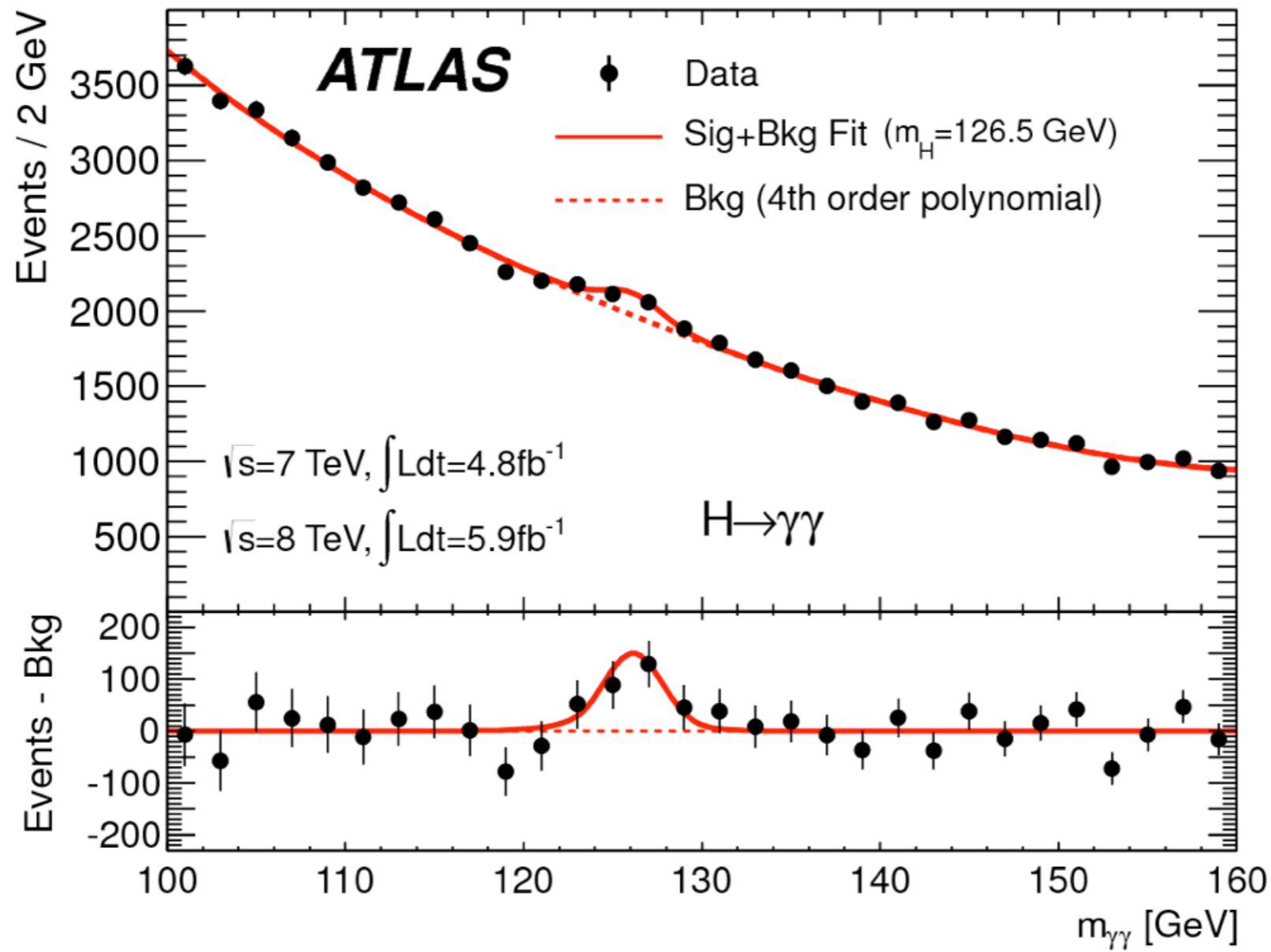

Example of particle ID in flavor physics

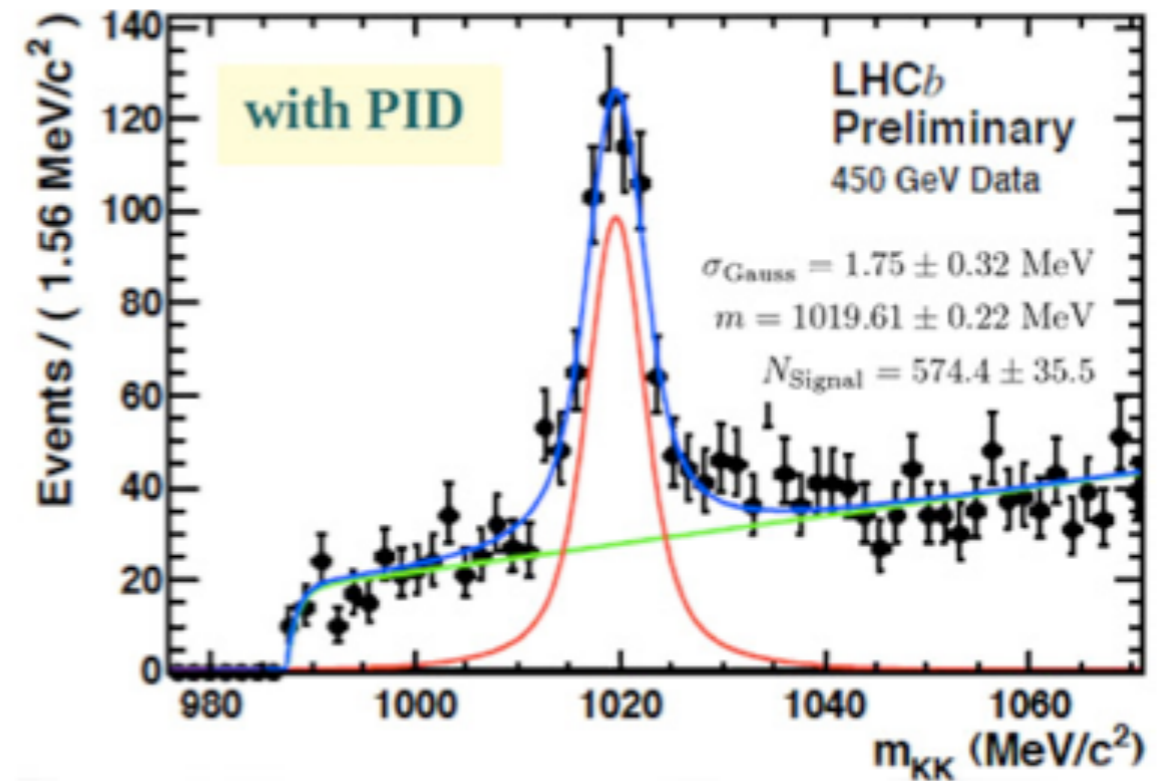
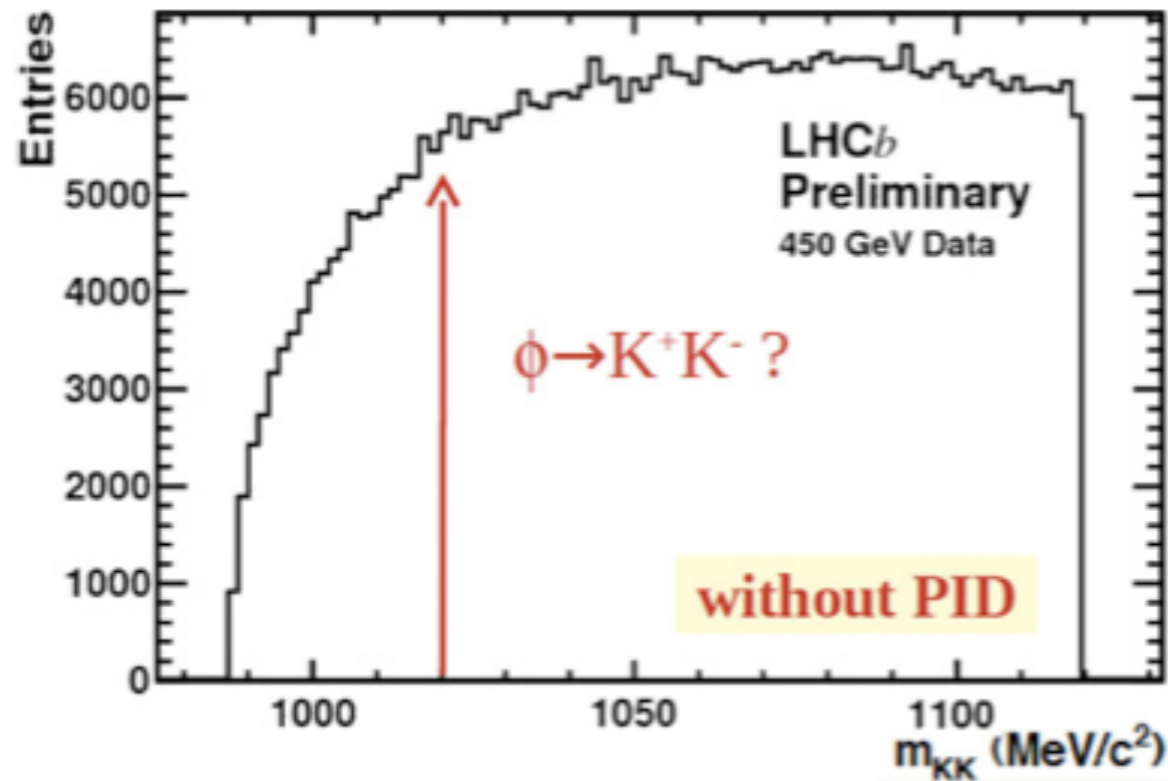

many more examples where K/pion
discrimination is important to study beauty
and charm decays

Particle identification covers a wide range of techniques

- **Exploit very different interaction of particles with matter** (for instance calorimeter)
 - electron/photon/muon/hadron discrimination, neutrinos
- **Measure mass of particle**
 - Mass and charge enough to identify a particle
 - Once energy or momentum are measured, mass can be measured through measurement of beta (velocity) or gamma
 - mass from beta measurement works better a low energy
- **Reconstruct decay of a particle to identify it**
 - «identify» H by mass peak in $H \rightarrow \gamma \gamma$
 - identify «long lived» particles by displaced decay vertex reconstruction

What is a «stable» particle ?

- Only few known particles are stable: photon, electron, proton, neutron(in nuclei), neutrinos
- Everything else decays but sometime are stable «enough» at the scale of the detector
- $L = \beta \gamma c \tau$
- Can a $E=40$ GeV muons ($\tau=2.2 \cdot 10^{-6}$ s) in a collider experiment (size ~ 20 m) be considered stable ?
- Can a $E=1$ GeV K_0 s ($\tau=8.9 \cdot 10^{-11}$ s) in a LHC experiment be considered stable ? And a K_0 ($\tau=5 \cdot 10^{-8}$ s) ?
- In which cases can a charged pion ($\tau=2.6 \cdot 10^{-8}$ s) be considered stable ? And a neutral pion ?
- Particle Identification depends on the experimental context and which particles are «directly» detected and which particle are «indirectly» detected (through their decay products)

What is a «stable» particle ?

- *Mean path length = $\beta \cdot \gamma \cdot c \cdot \tau$*
- Can a $E=40$ GeV muons ($\tau=2.2 \cdot 10^{-6}$ s) in a collider experiment (size ~ 20 m) be considered stable ?
 - $\Rightarrow \gamma \sim 380, L \sim 250$ km
- Can a $E=1$ GeV K_0 s ($\tau=8.9 \cdot 10^{-11}$ s) in a LHC experiment be considered stable ? And a K_0L ($\tau=5 \cdot 10^{-8}$ s) ?
 - $\Rightarrow \gamma \sim 2, L \sim 5$ cm for K_0 s, $L \sim 30$ m (K_0L)
 - $K_s \rightarrow \pi^+\pi^-$ or $\pi^0 \pi^0$
- In which cases can a charged pion ($\tau=2.6 \cdot 10^{-8}$ s) be considered stable ? And a neutral pion ?
 - $L > \sim m$ if $\beta > \sim 0.1$ for charged pions. π^0 lifetime $8 \cdot 10^{-17}$ s \Rightarrow \sim never «stable»

Example of an experiment looking for new ultra rare muon decay

The MEG experiment (arXiv:1303.2348)

- A search for $\mu \rightarrow e \gamma$ with the most intense DC muon beam of the world ($3 \times 10^7 \mu/s$ @ PSI, Switzerland);
- Running since 2008.

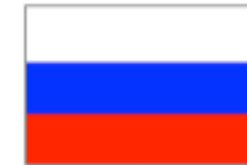

A CERN-recognized experiment since 2005 (RE-12)

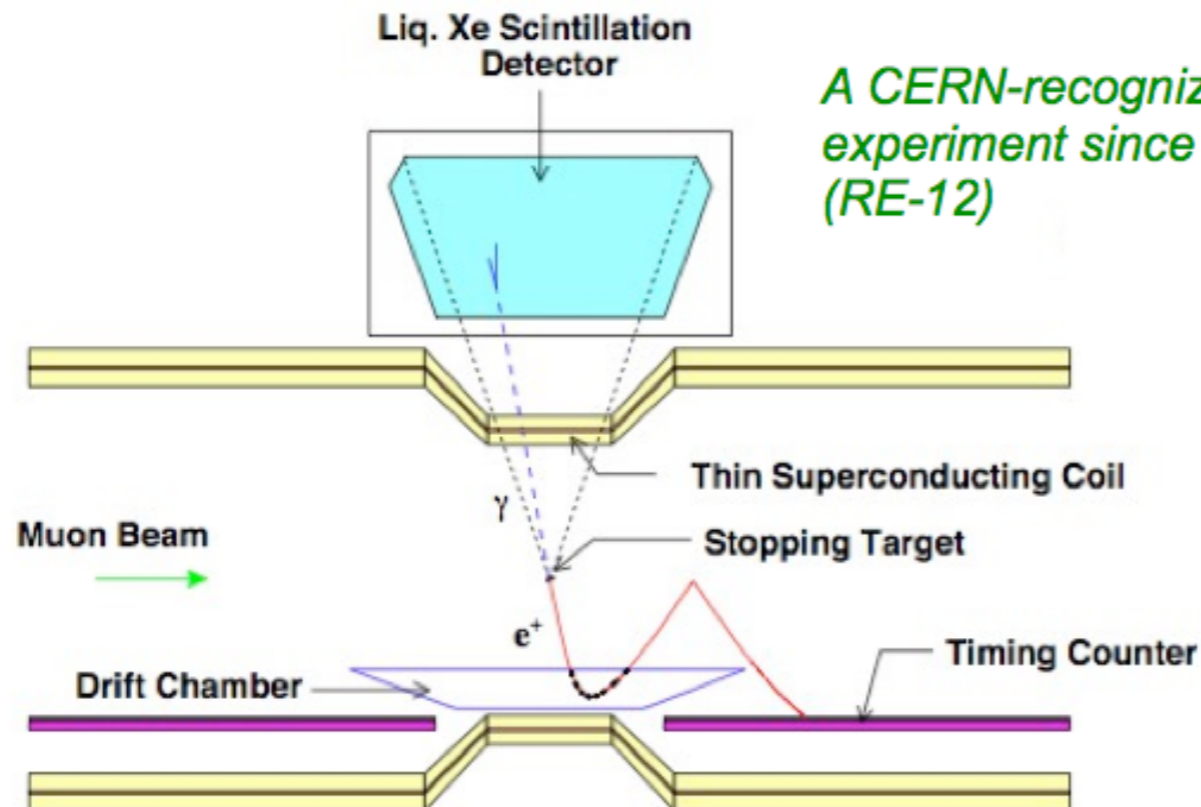

LXe calorimeter for photon detection

16 drift chambers for positron tracking

30 scintillating bars for positron timing and trigger (Timing Counter, TC)

Exploiting different interactions with matter

- Mostly useful for e / muon / «hadron» discrimination
- In collider, high energy hadrons are not isolated but produced in «jets» from high energy quark and gluons
- Neutrinos are a special case

Muon energy loss

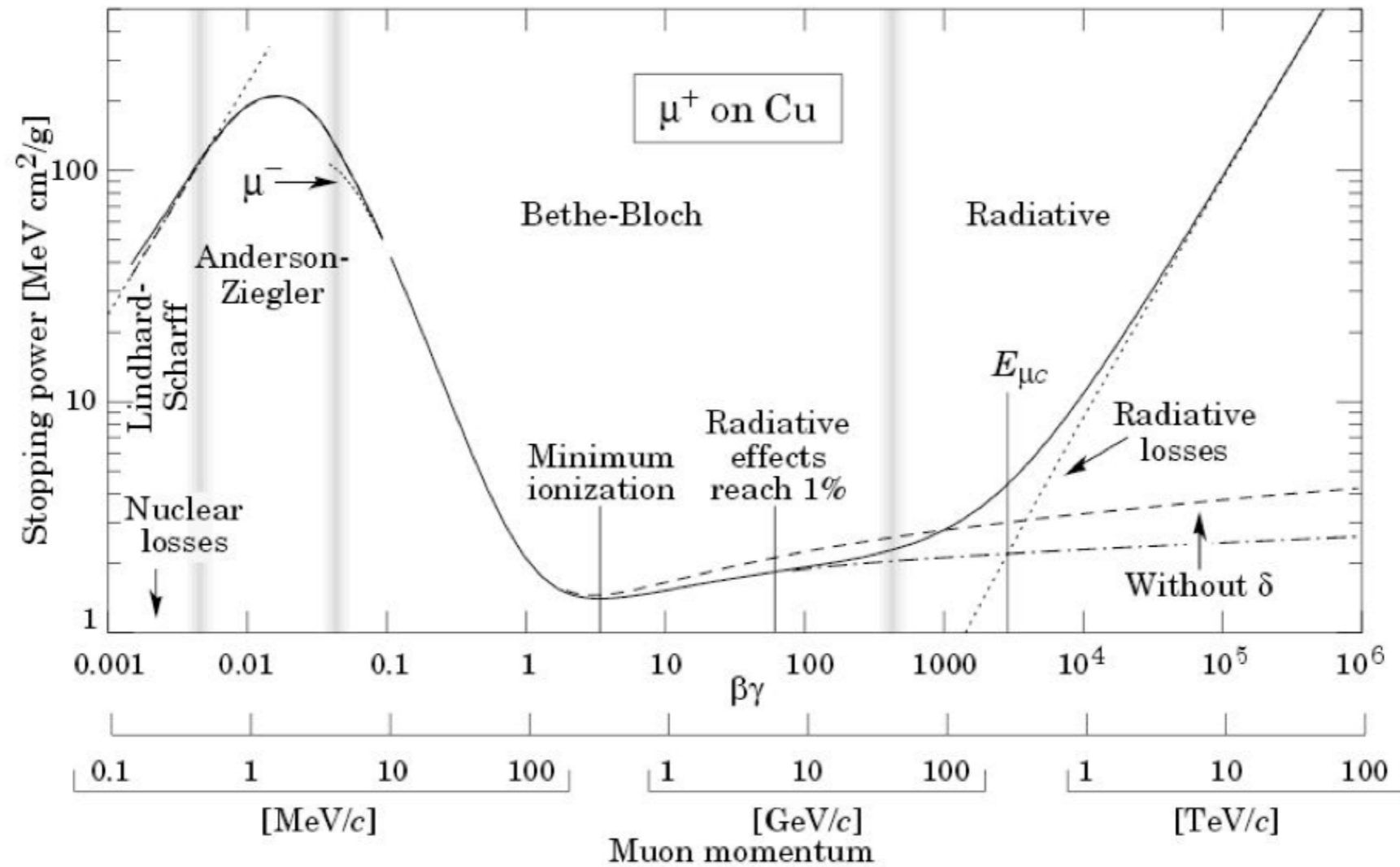

Ionization

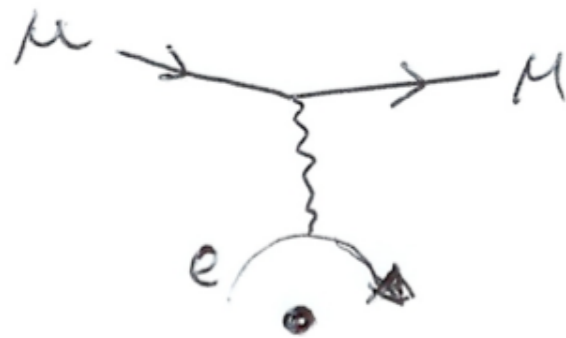

Bremsstrahlung



Electron energy loss

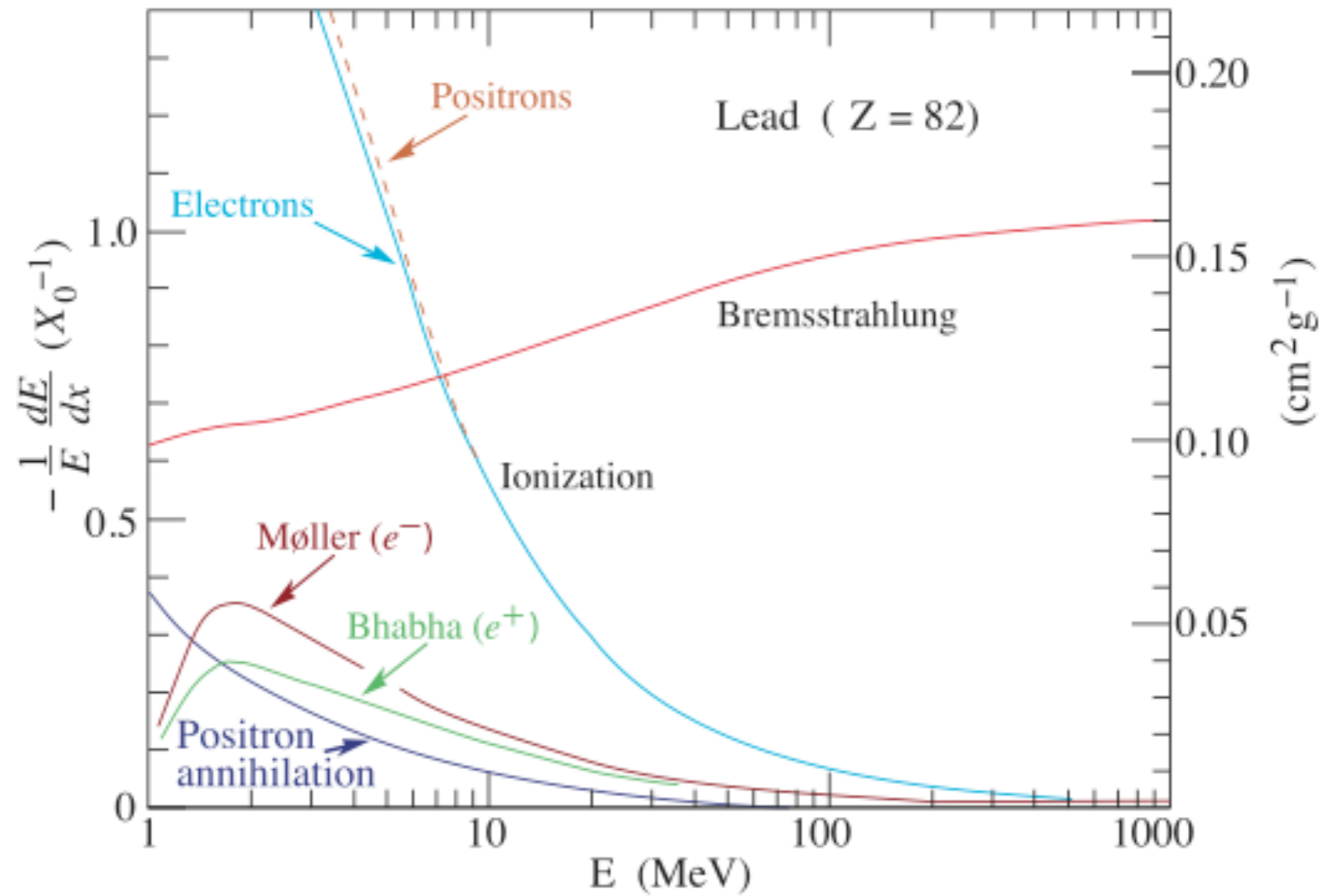

Sketch of particle interactions in detector

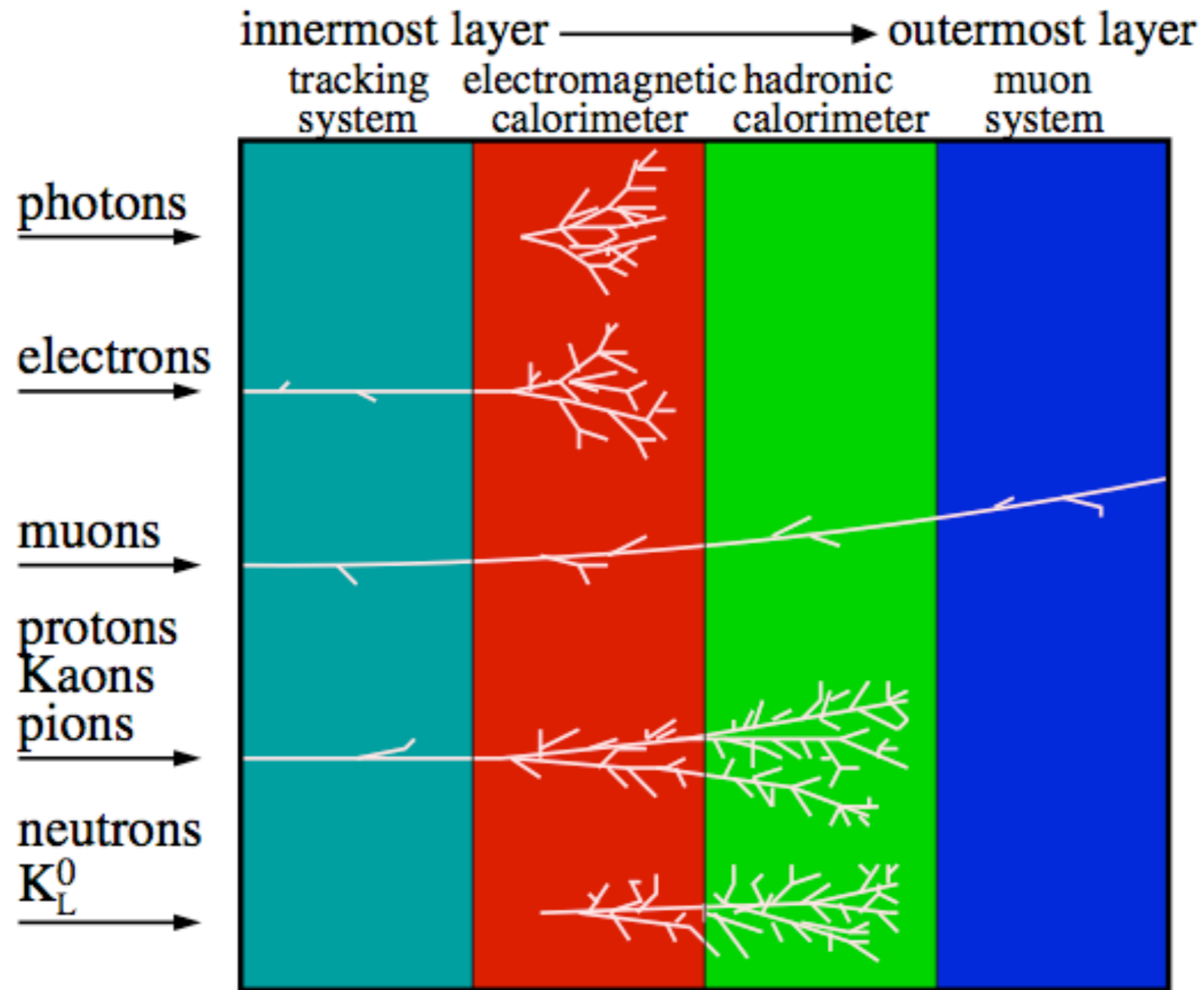

C. Lippmann - 2003

X_0 = distance in which electron energy is reduced by $1/e$ by bremsstrahlung
 Λ_I = interaction length for hadronic interaction

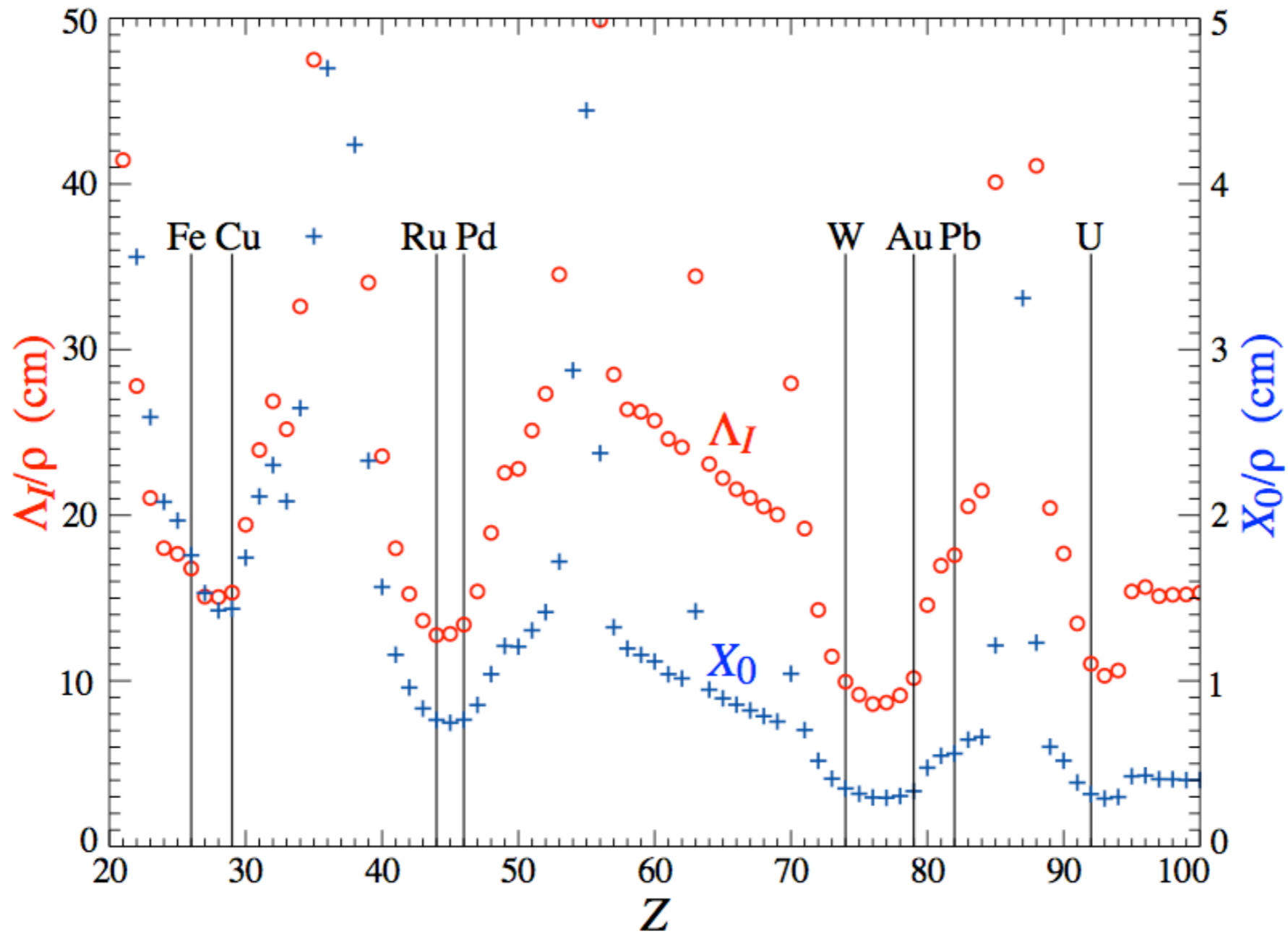

$$X_0 = \frac{716.4 \cdot A}{Z(Z+1) \ln \frac{287}{\sqrt{Z}}} \text{ g} \cdot \text{cm}^{-2}$$

How thick should a hadron calorimeter be ?

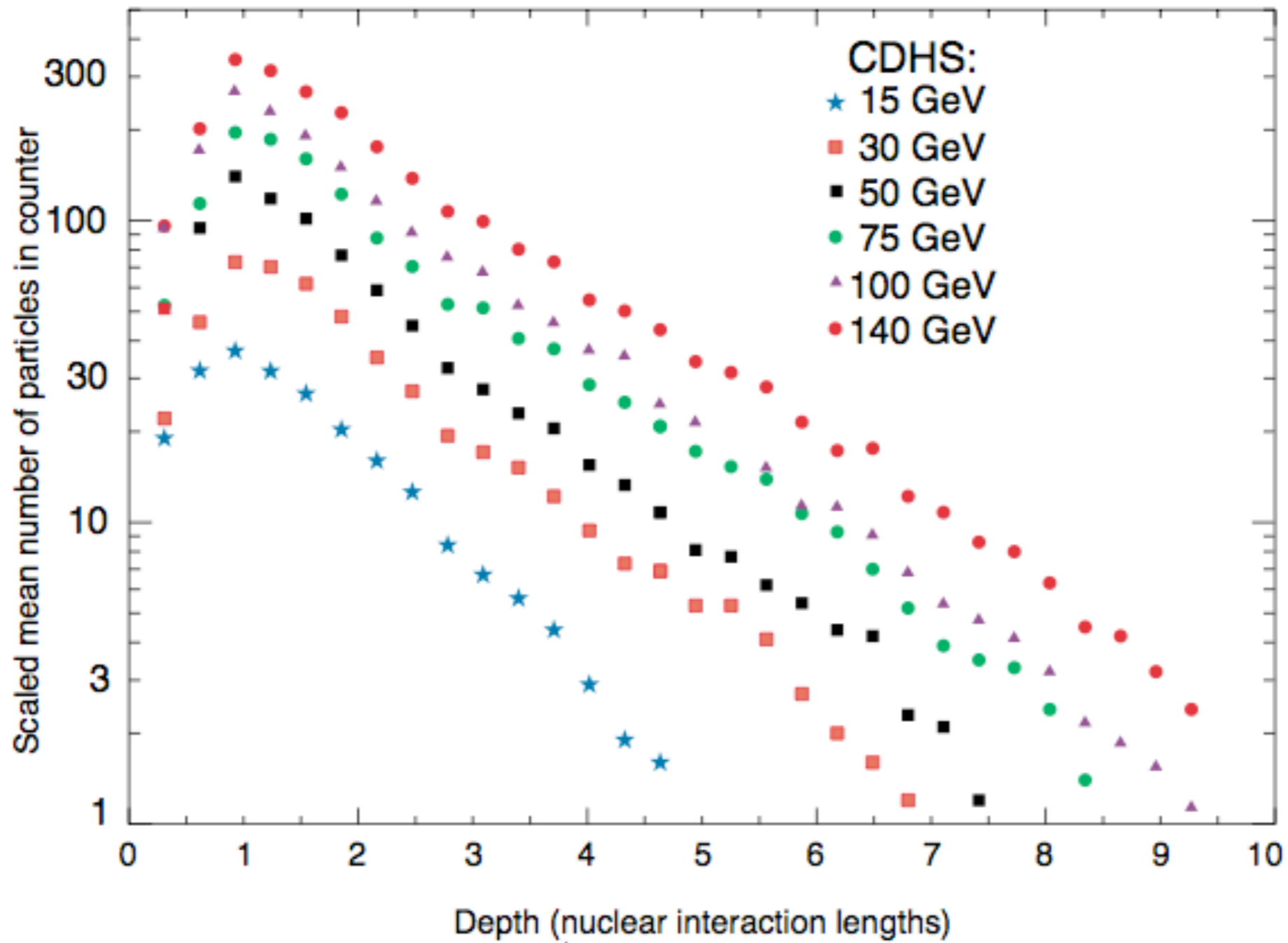

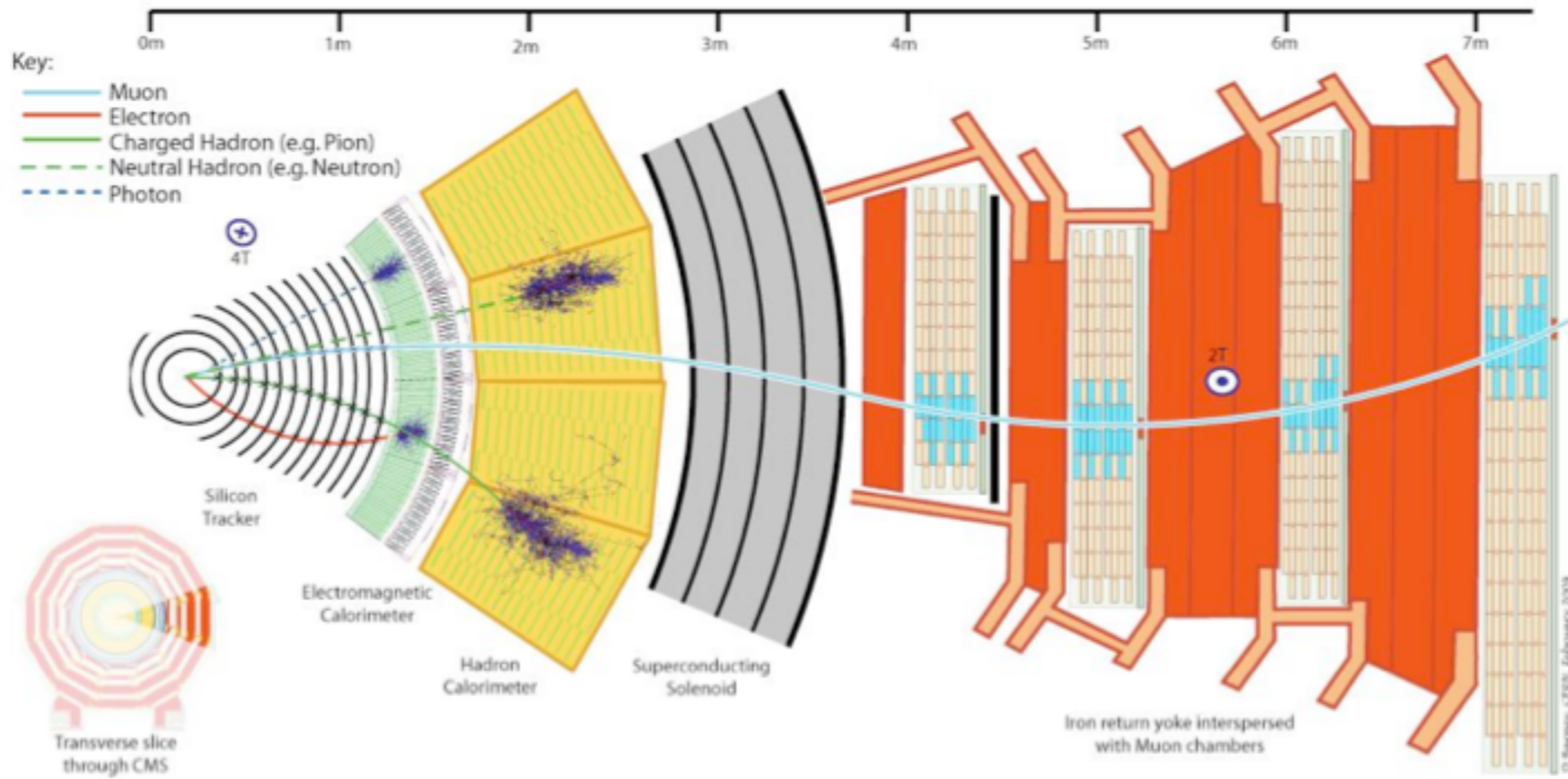

Calorimeter showers initiated by e / photon

longitudinal

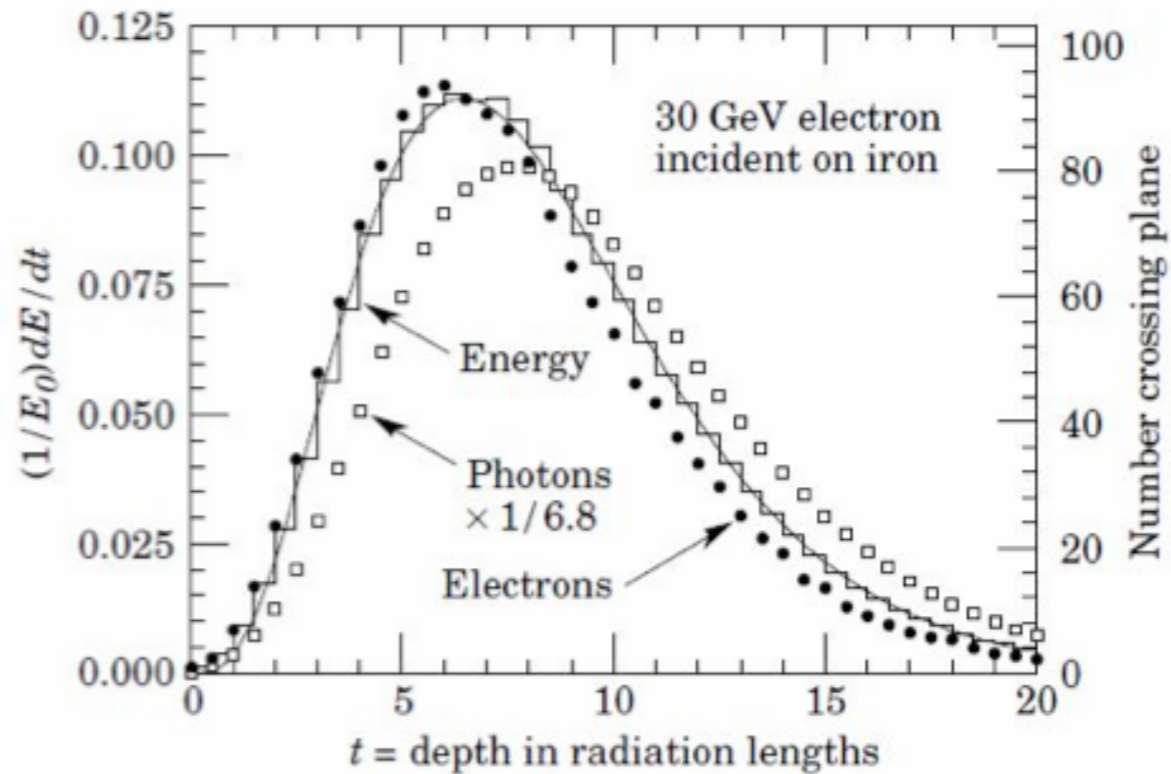

lateral

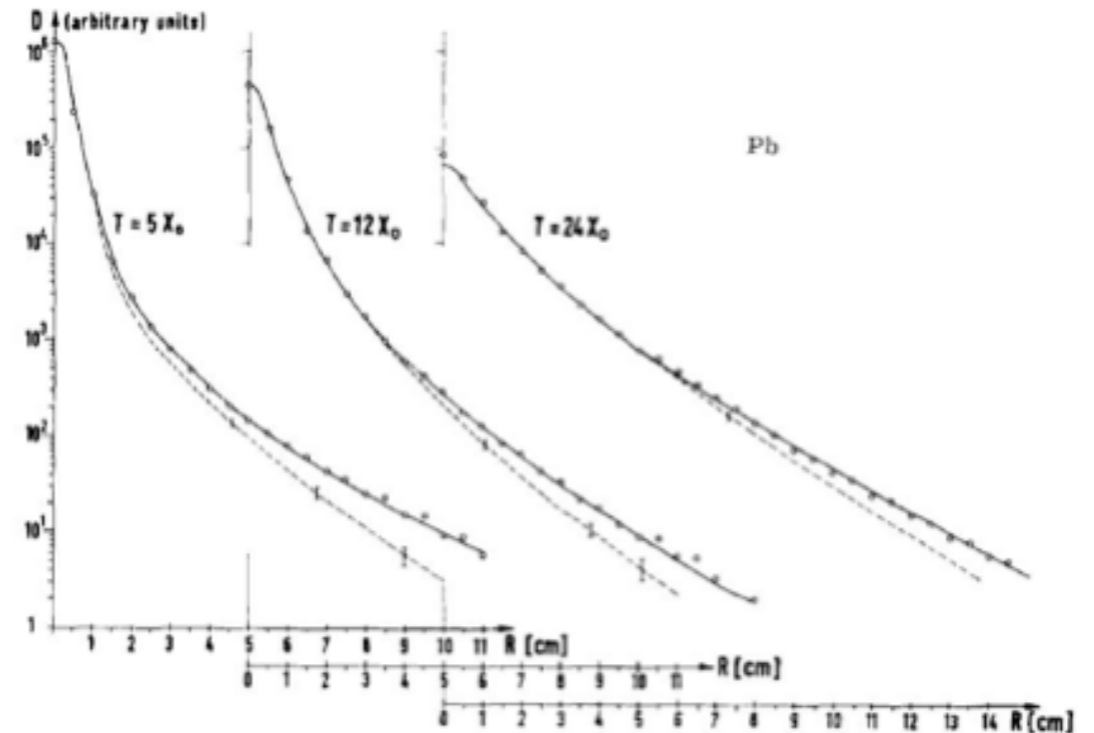

Fig. 4. Measured lateral distribution for lead (circles) in comparison with Monte-Carlo results (dotted line with error bars).

Difference electron-photon ?

Photon has to convert first
 $P(\text{not convert}) \sim \exp(-7/9 * x/x_0)$

Moliere radius $\sim X_0 \cdot (21 \text{ MeV}/E_c)$
 cylinder of $\sim 2 R_m$ contains
 $\sim 95\%$ of energy

Electron identification in hadron colliders

- High energy charged leptons are usually indication of «interesting» physics events, for instance decays of W or Z boson
- What are the backgrounds ?
- How to distinguish «good» electrons from them ?

Description of different type of electron backgrounds

Isolated electron

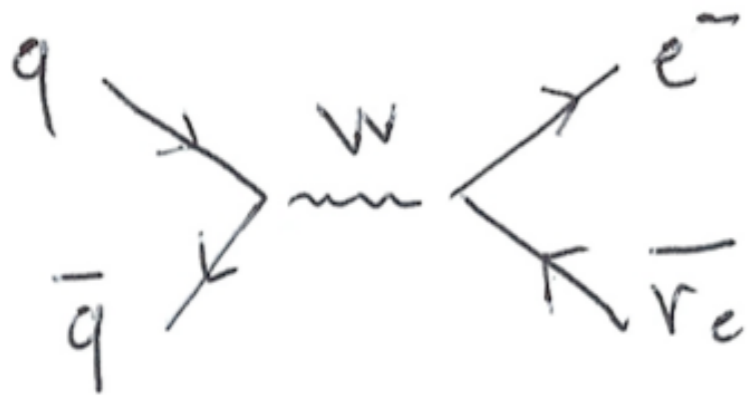

Non-Isolated electron

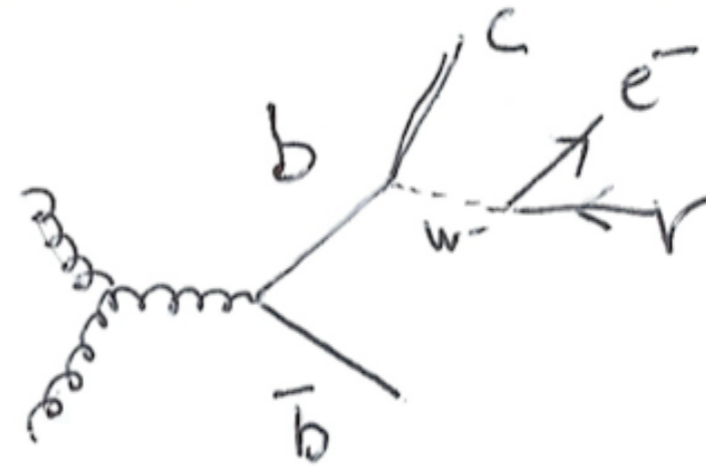

Hadrons

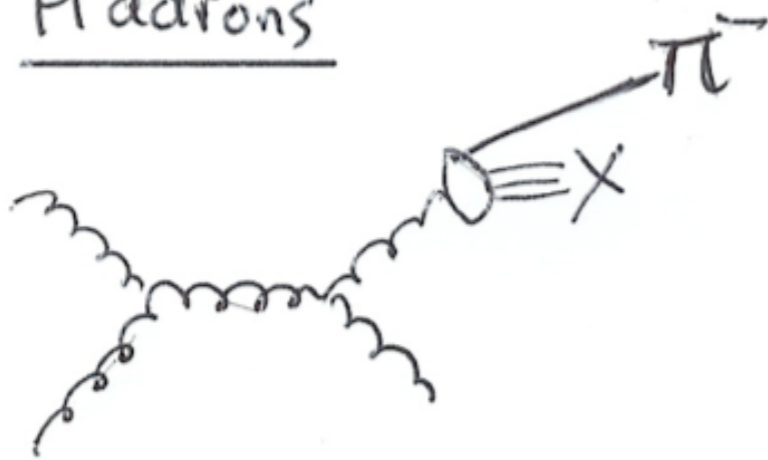

Background electron

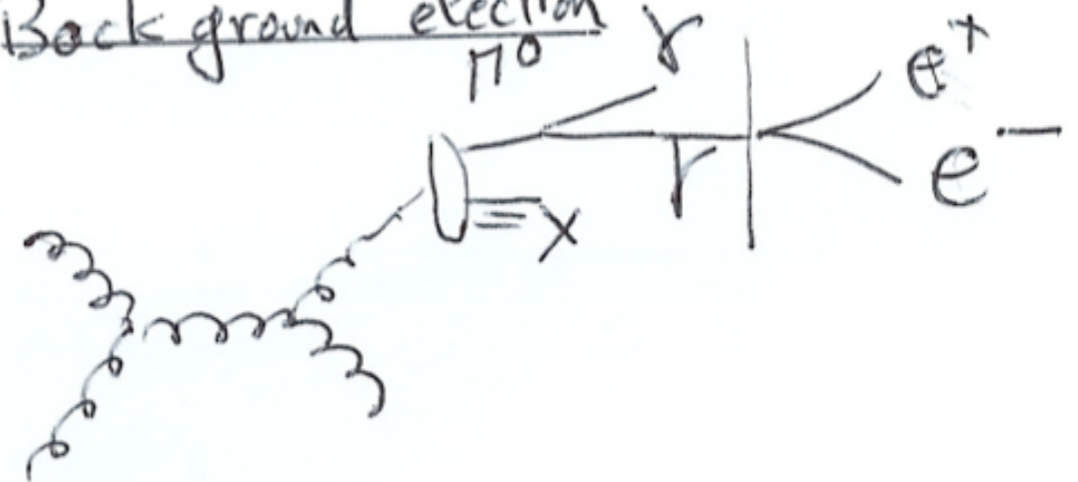

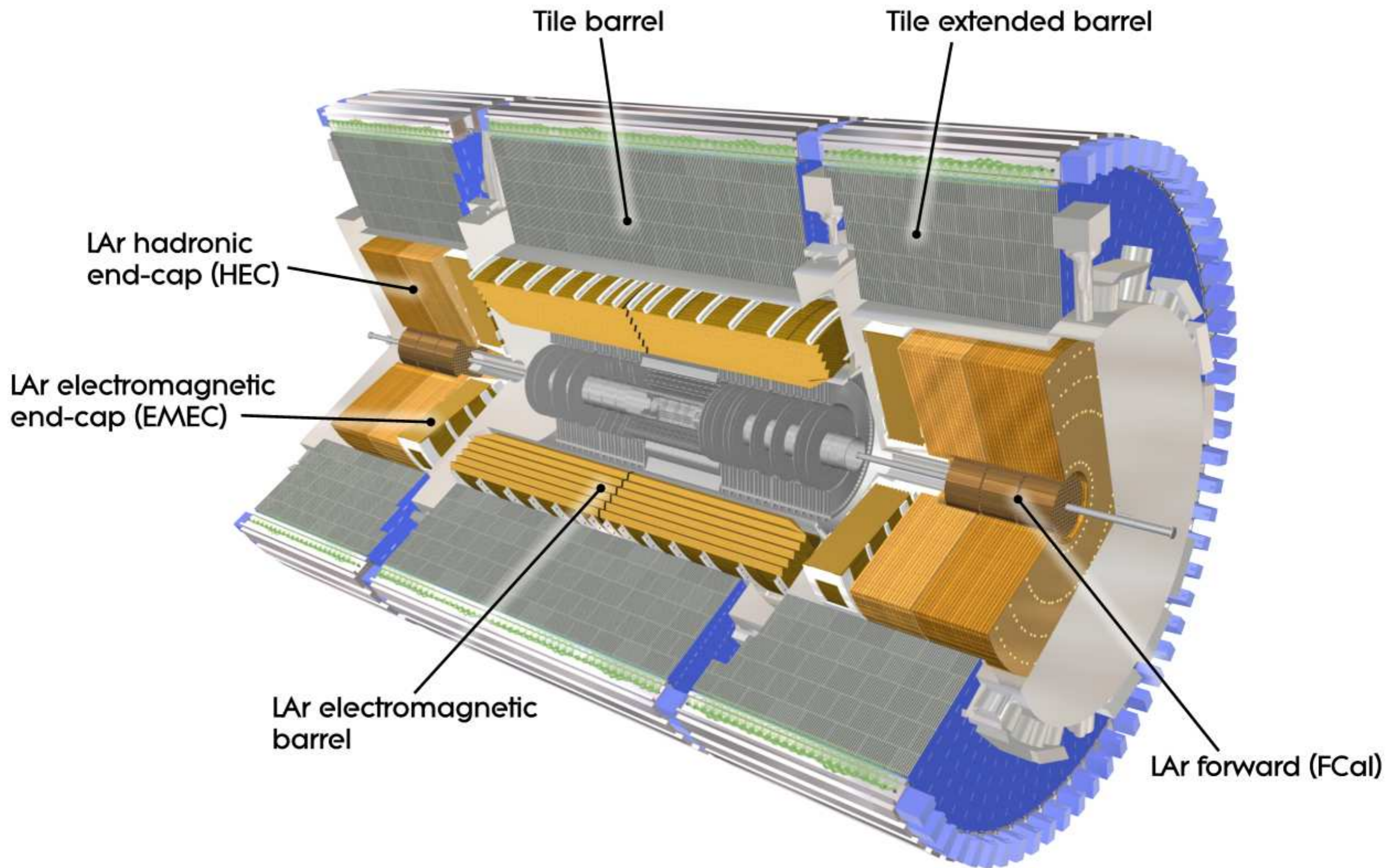

Granularity of EM calorimeter to measure shower development

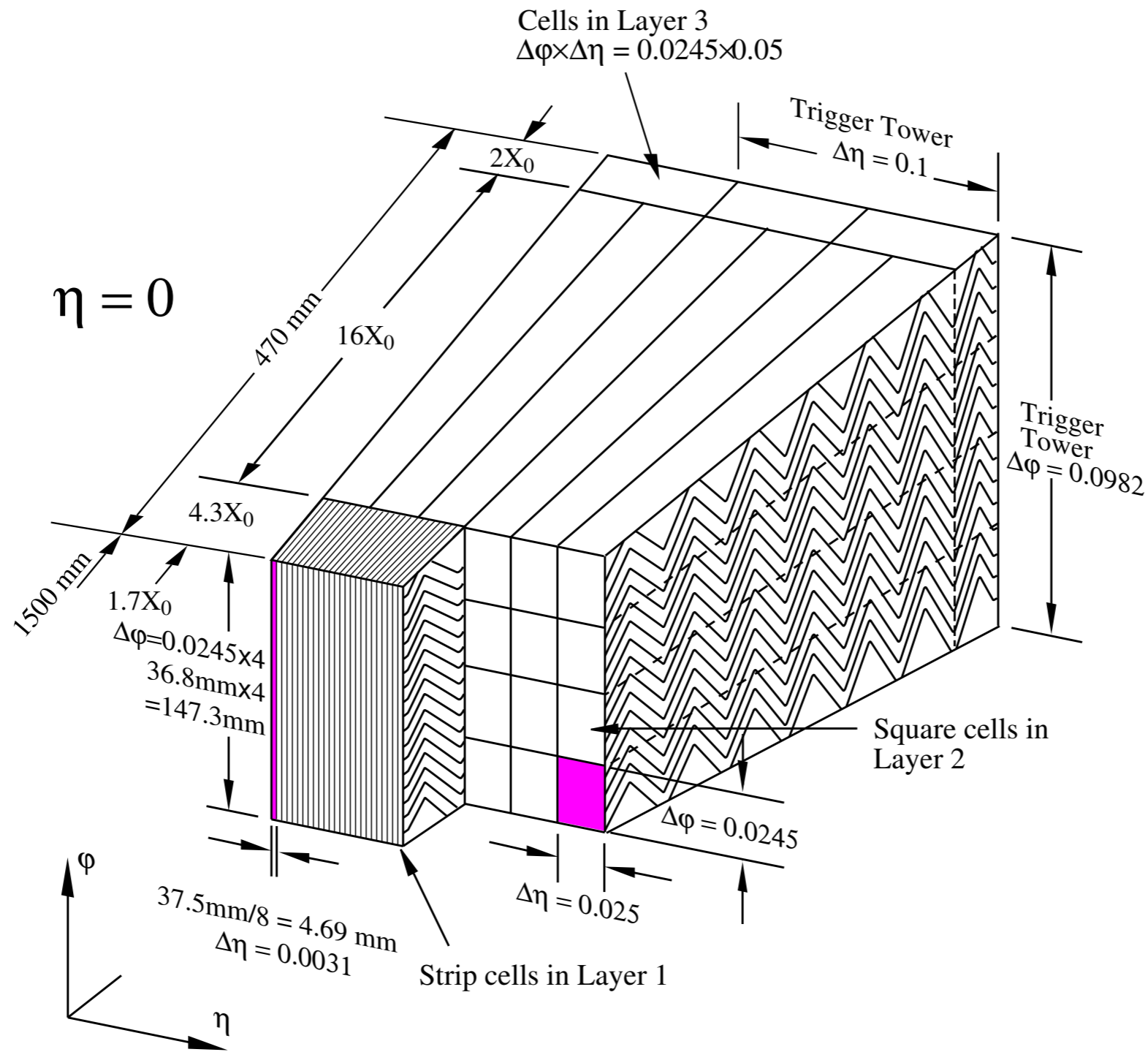

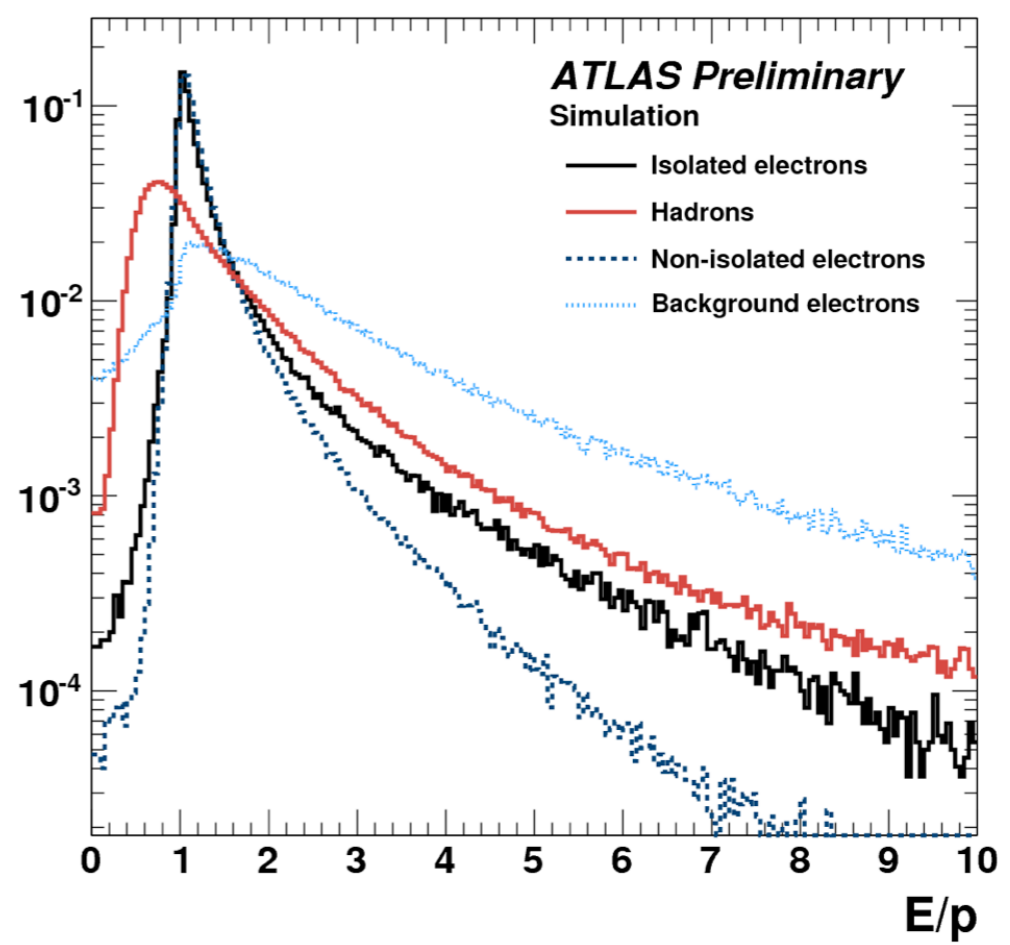
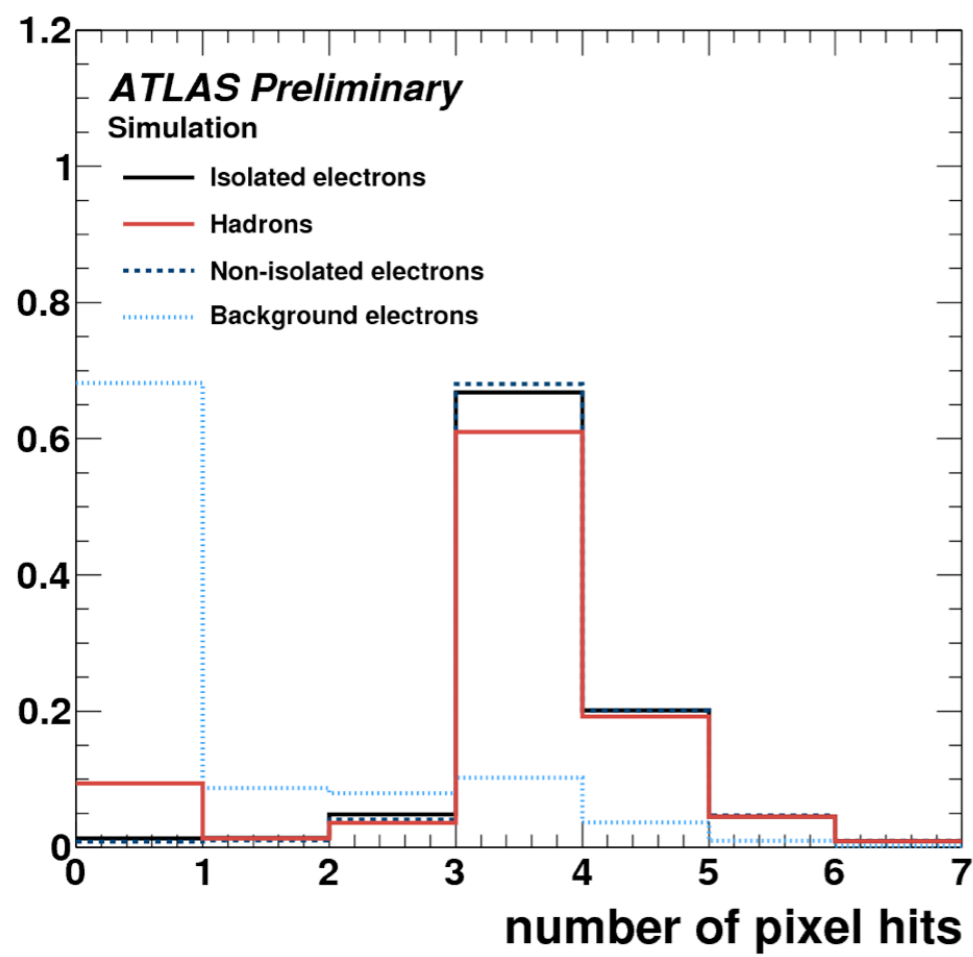
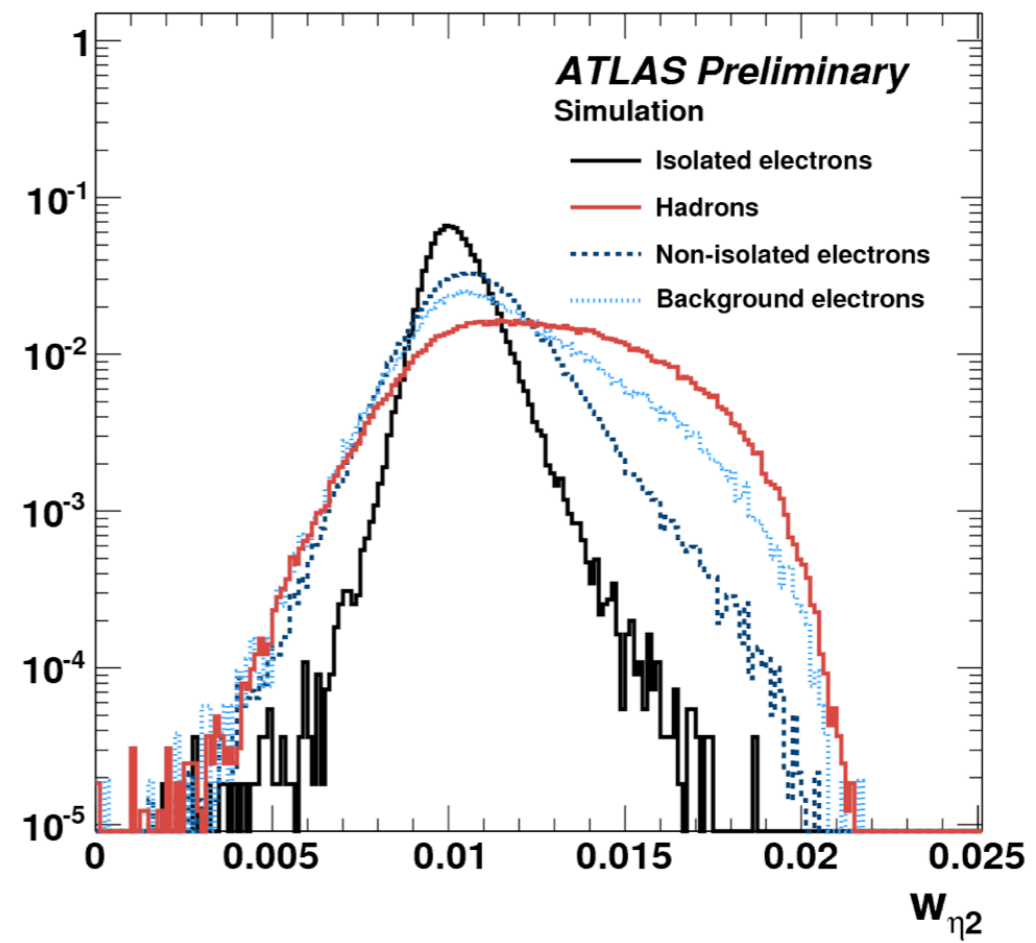
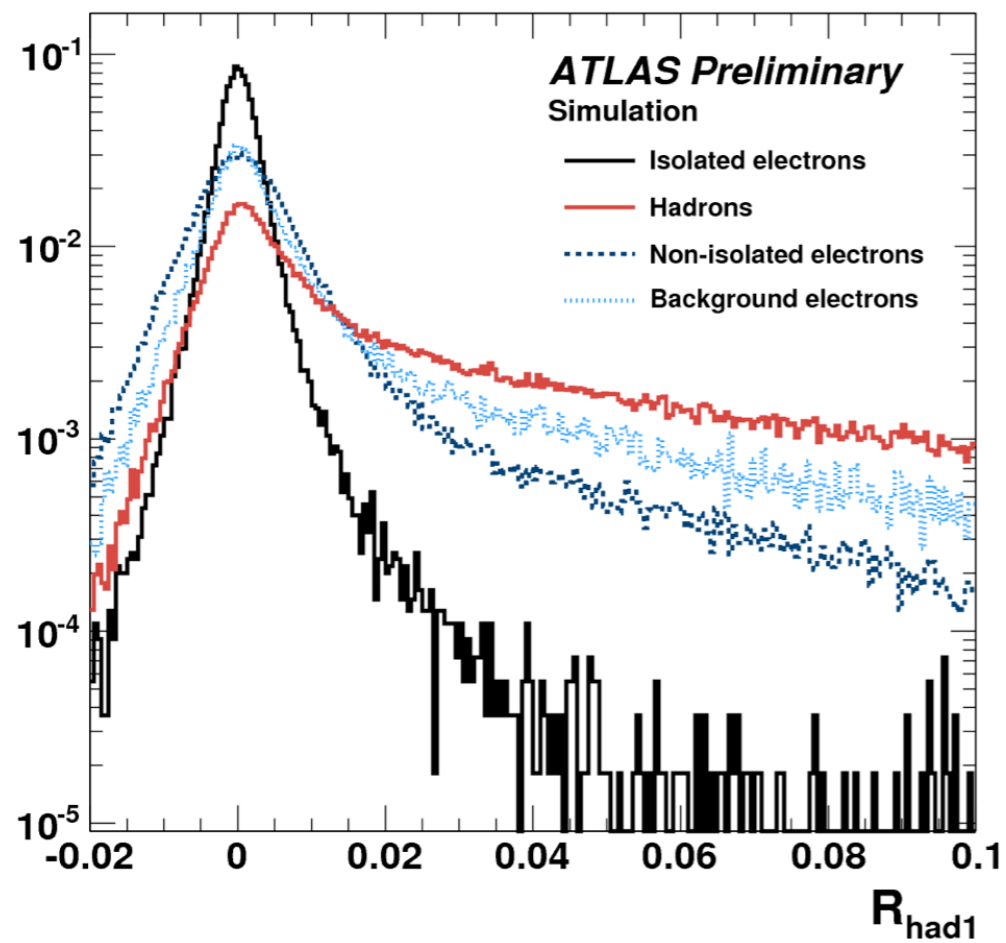

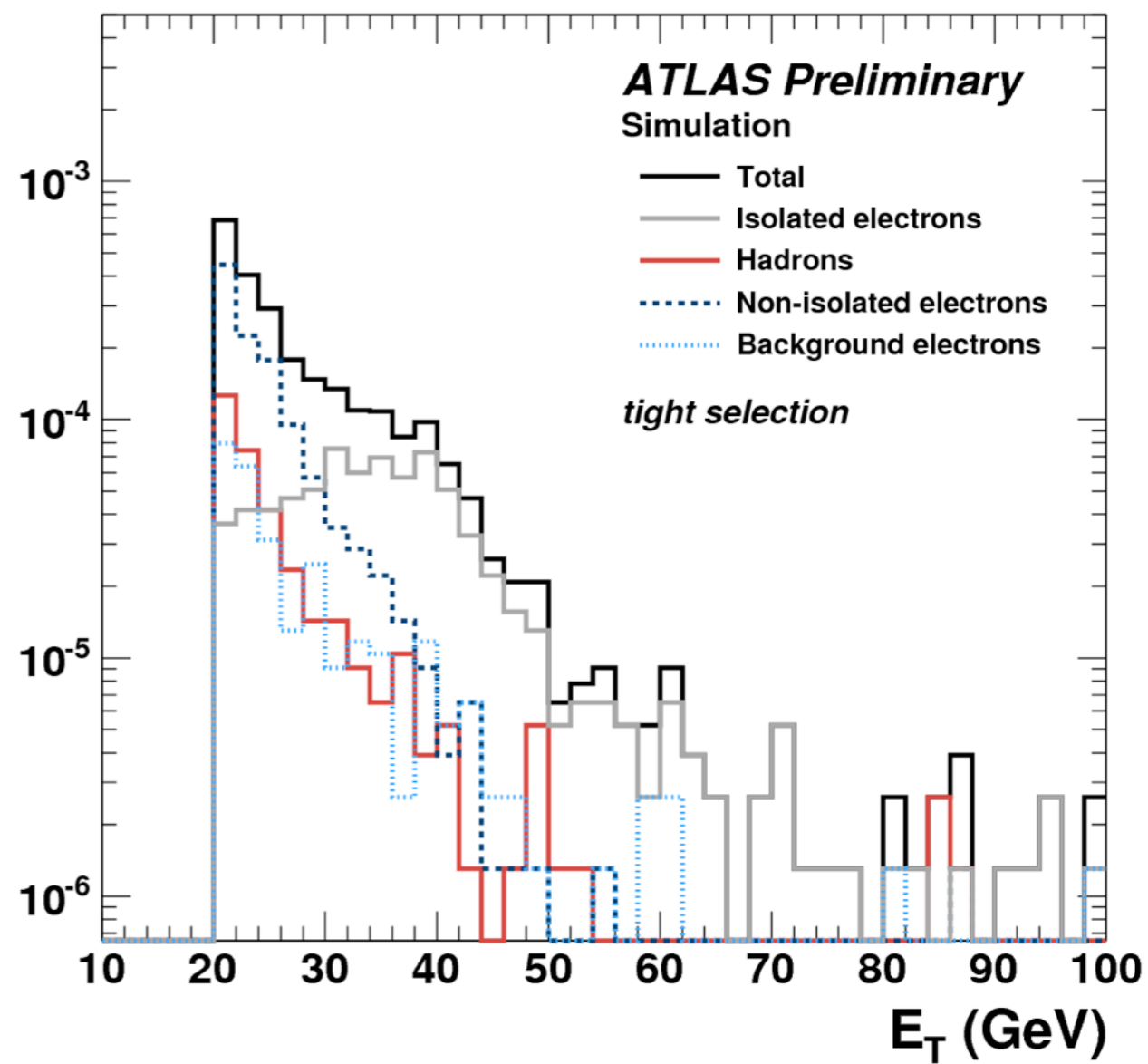
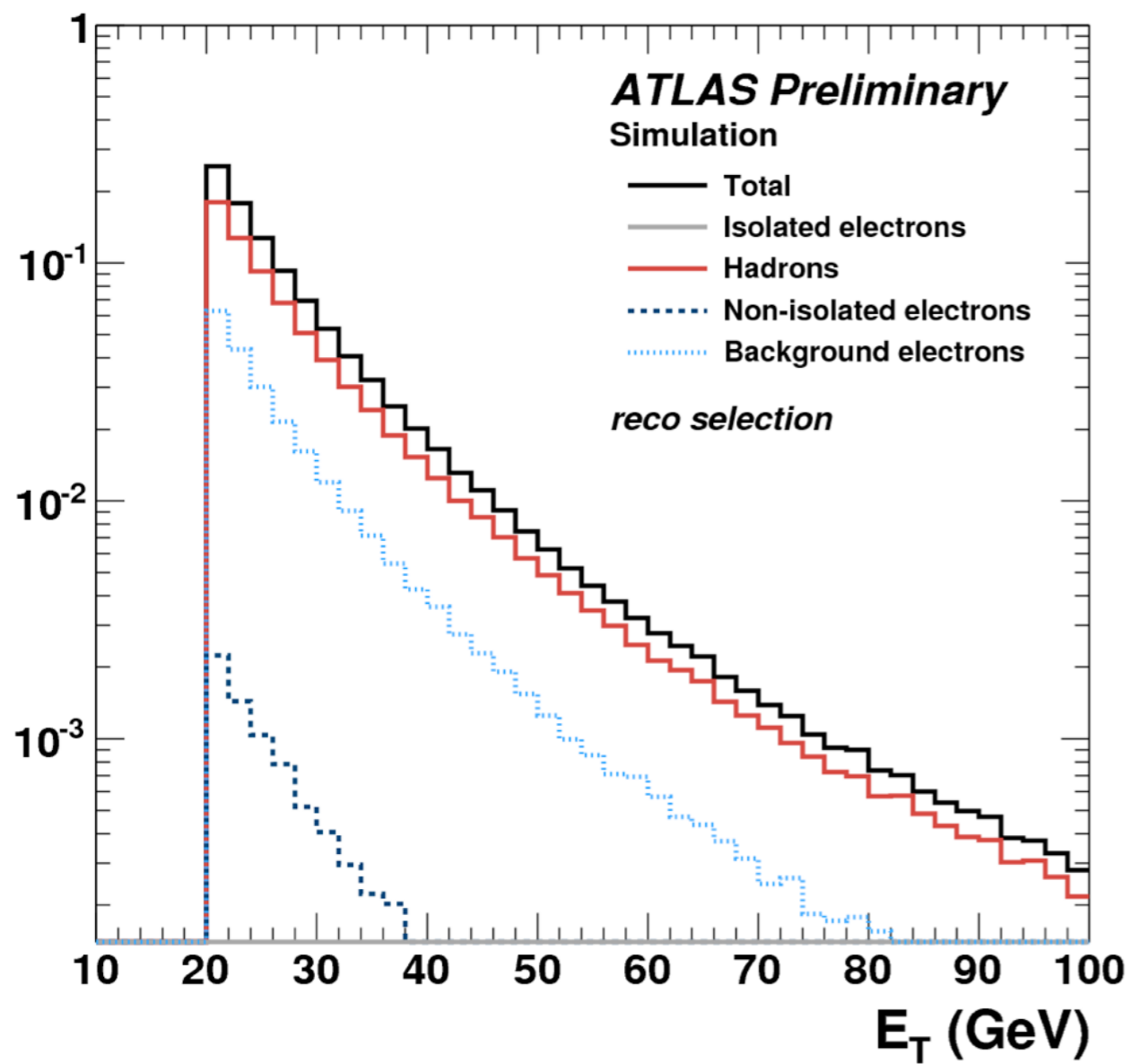

Combine different variables in a multivariate discriminant (likelihood, boosted decision tree, neural network. etc..)

$$d_{\mathcal{L}} = \frac{\mathcal{L}_S}{\mathcal{L}_S + \mathcal{L}_B}, \quad \mathcal{L}_{S(B)}(\vec{x}) = \prod_{i=1}^n P_{S(B),i}(x_i)$$

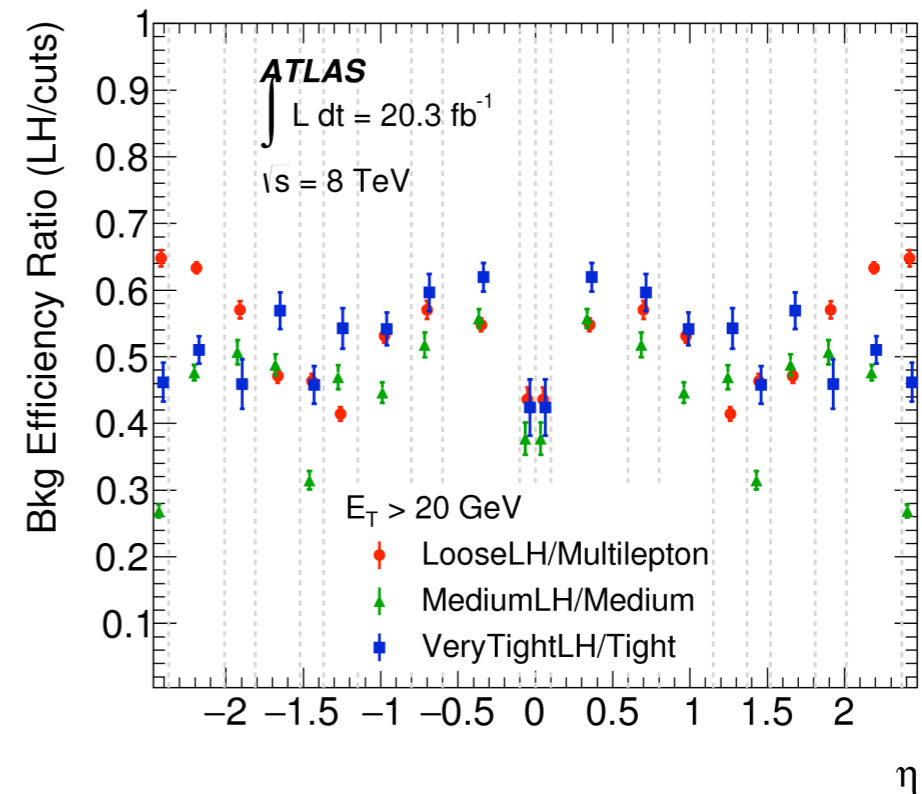

Need data-driven measurement for precise knowledge of identification efficiency => Possible in LHC experiments thanks to large statistics of $Z \rightarrow ee$ decays

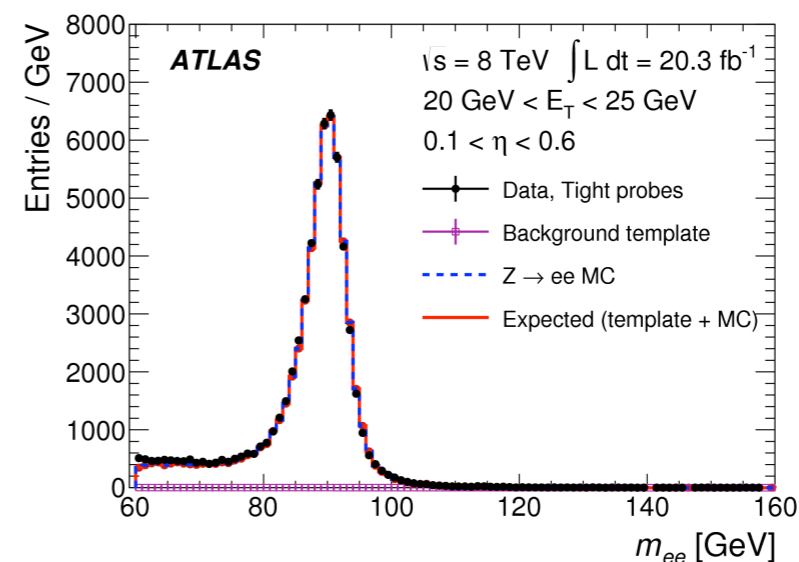
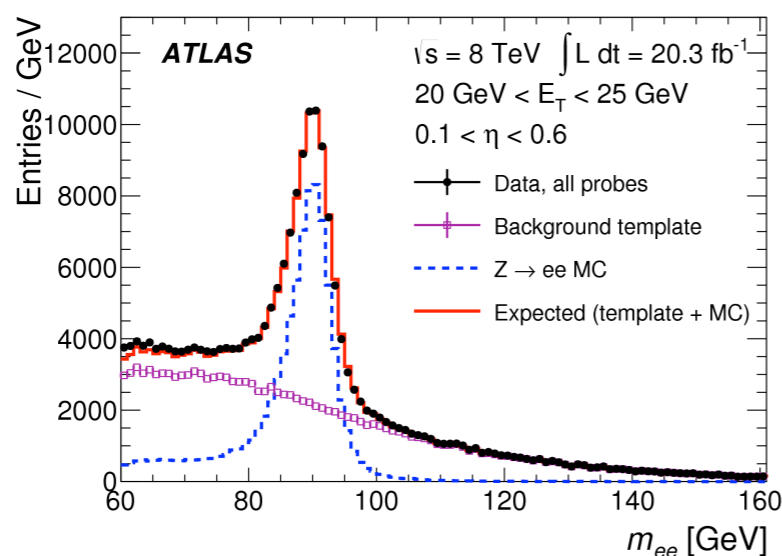

Electron charge

Calorimeter does not measure electron charge
Use track curvature in magnetic field for that
Main possibility of mistake for electron: Interaction with the inner detector material giving rise to bremsstrahlung and conversions and not getting the «right» track

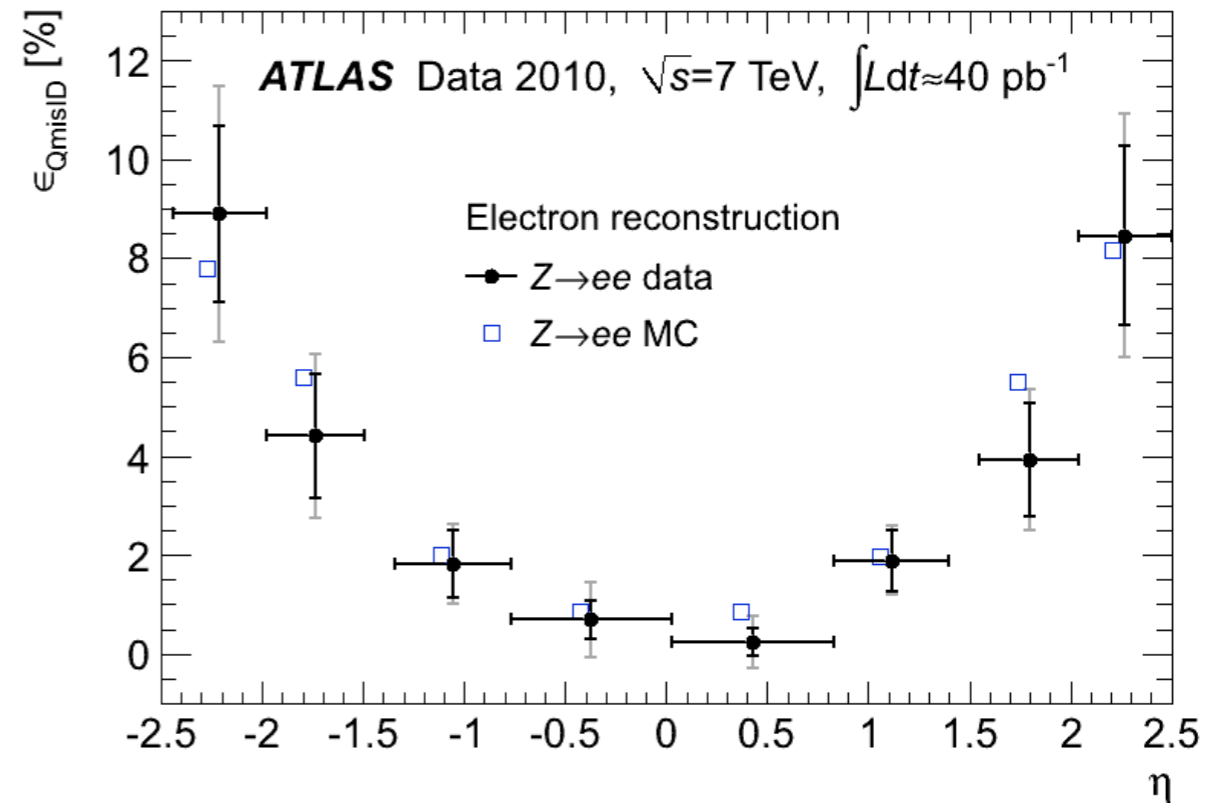
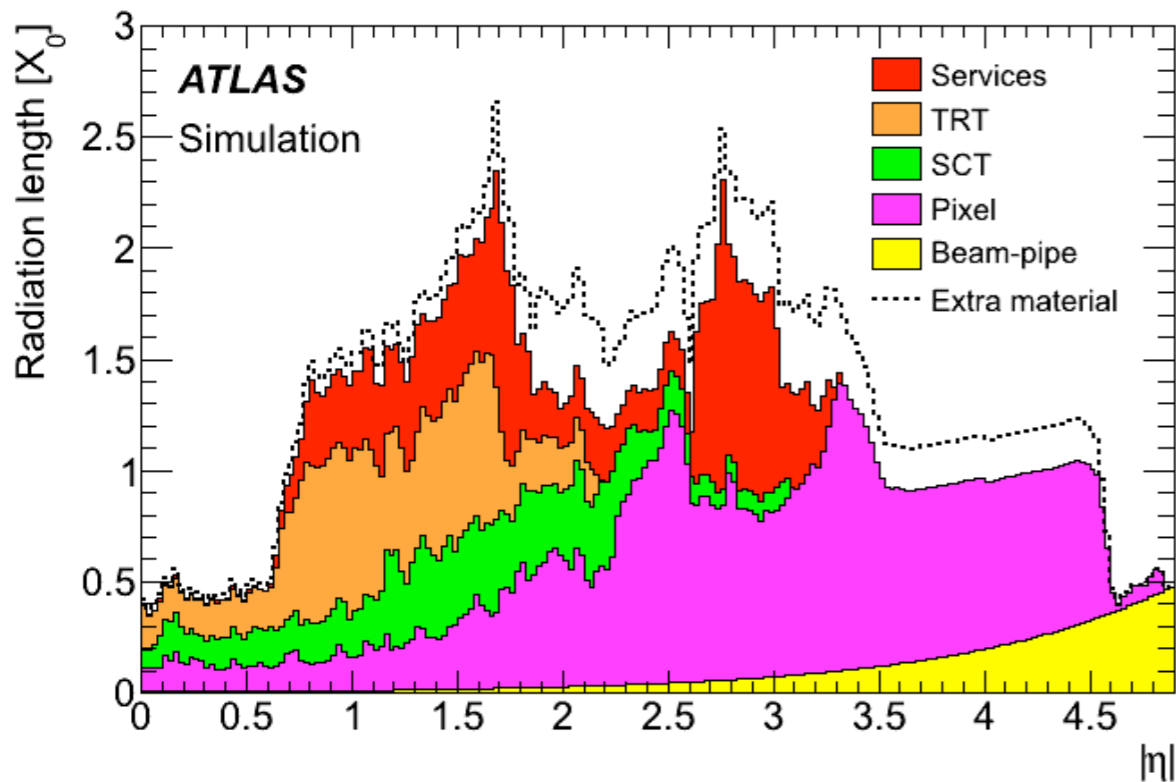
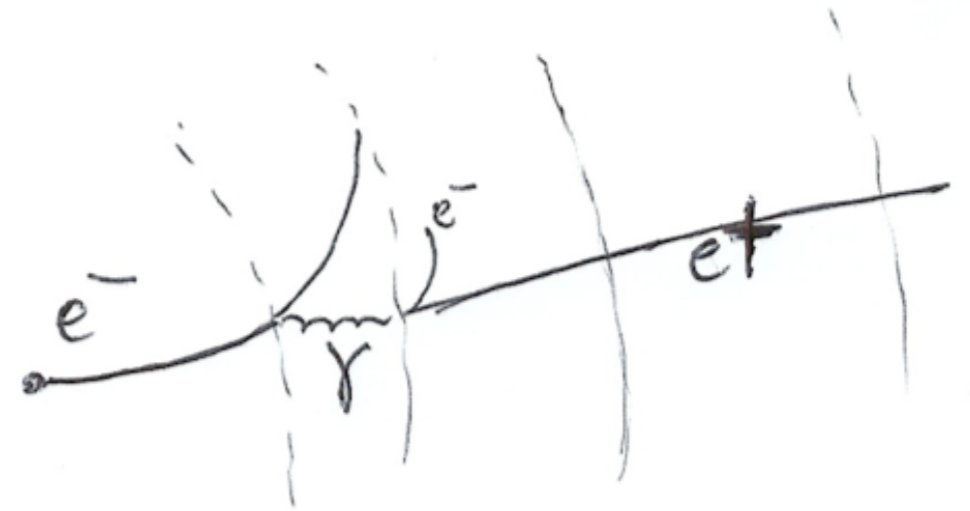

Photon identification in collider experiment

Background from high energy $\pi^0 \rightarrow \gamma \gamma$

What is the separation between the photons ?

What information can be exploited ?

$\theta_{\min} \sim 2/\gamma$

~ 0.0067 at $E=40$ GeV

$\Rightarrow 1$ cm @ $R=150$ cm

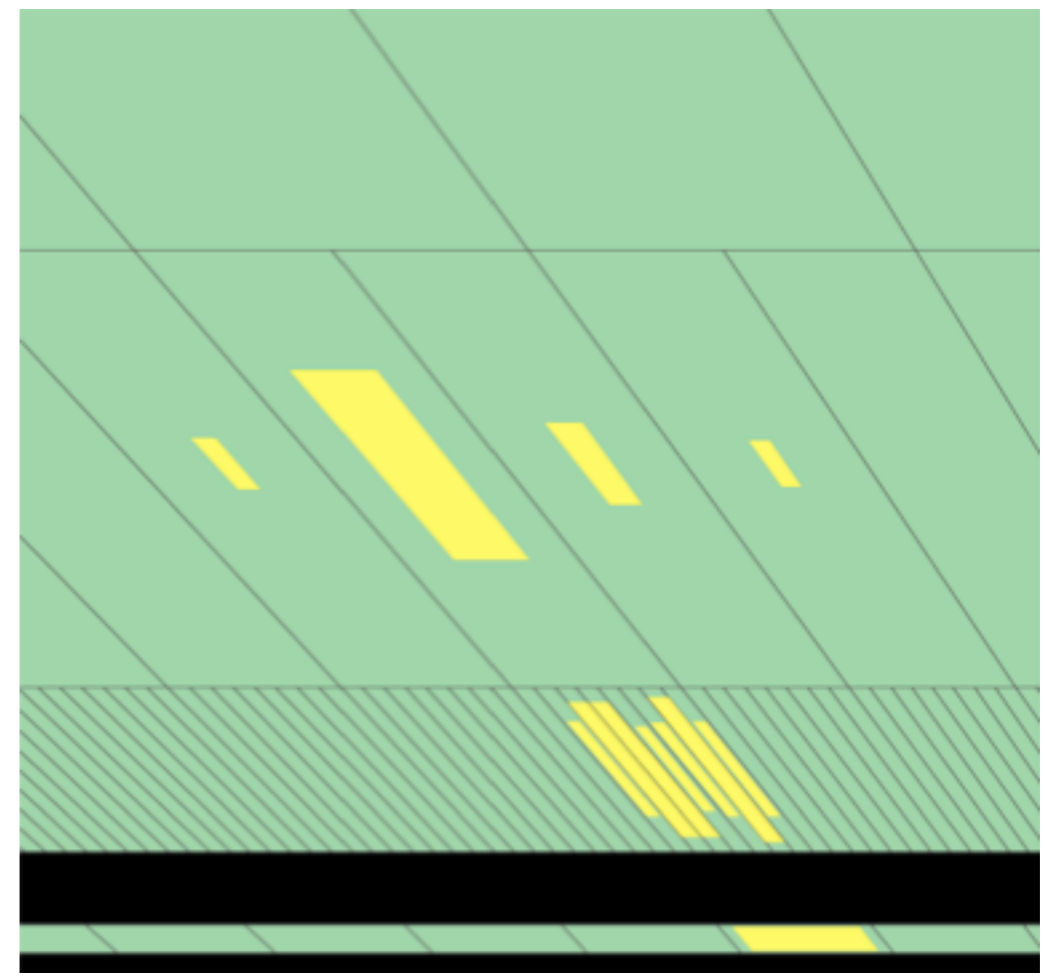
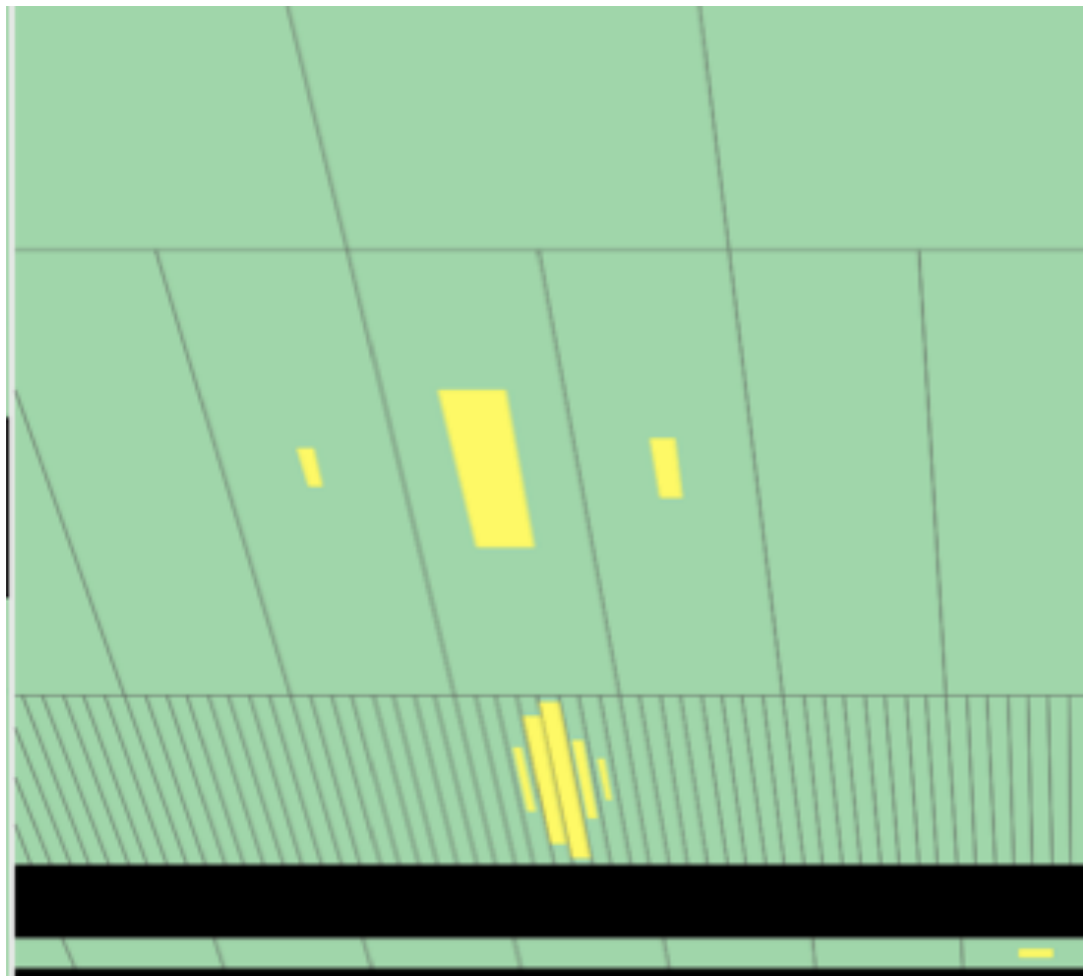

Example of photon identification performance in ATLAS

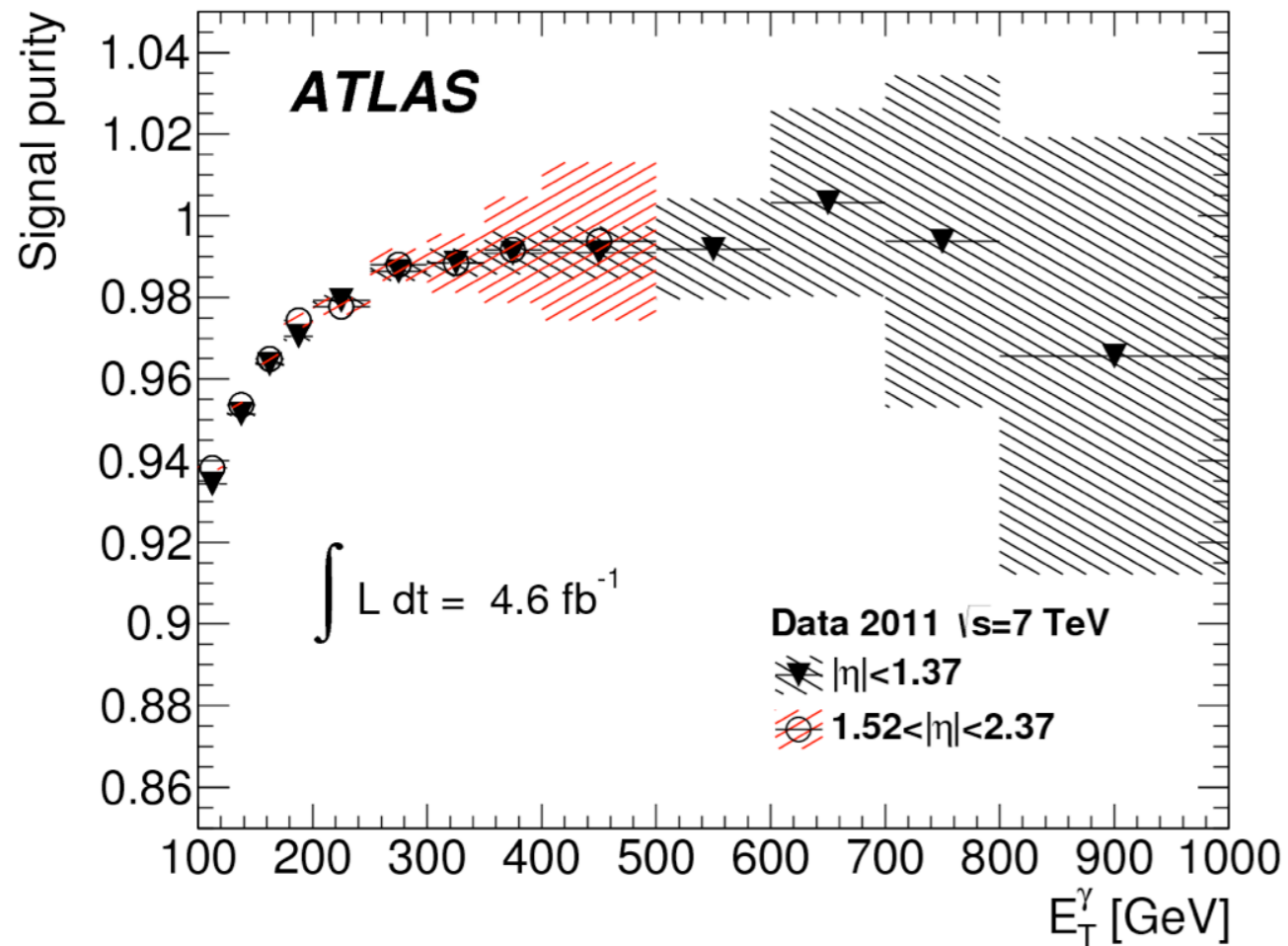

High energy inclusive
photon
Purity >95%

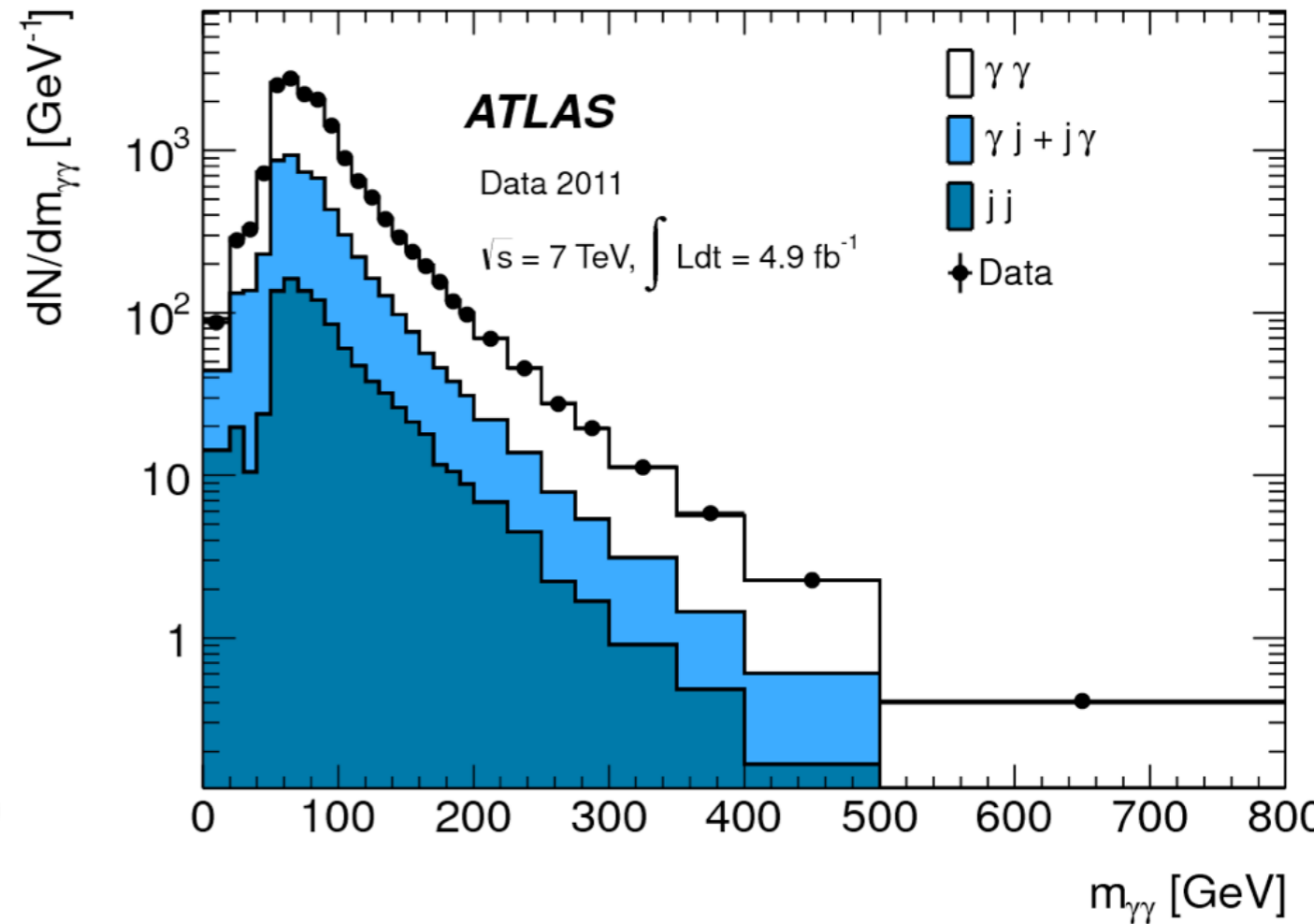

Di photon events at intermediate mass
Purity ~70-80%

Some of these techniques are also used in Space

- Fermi LAT : identify and measure ~ 50 MeV to ~ 300 GeV gamma rays with good angular resolution
- AMS : look for antimatter in space \Rightarrow particle identification and charge measurement

Fermi LAT

4x4 array of identical towers (tracker + calorimeter) surrounded by an Anti-Coincidence Detector

Tracker

- 18 layers (x-y) with silicon strip detectors + tungsten conversion foil
- 2 sections (depending on W thickness):
 - Thin (front) : $12 \times 0.03 X_0$
 - Thick (back) : $4 \times 0.18 X_0$
 - No W in the 2 bottom layers
- $1.4 X_0$ on axis

Calorimeter

- $8.6 X_0$
- 96 CsI crystals per module

Anti-Coincidence Detector

- 89 plastic scintillator tiles
- 0.9997 detection efficiency for minimum-ionizing particles

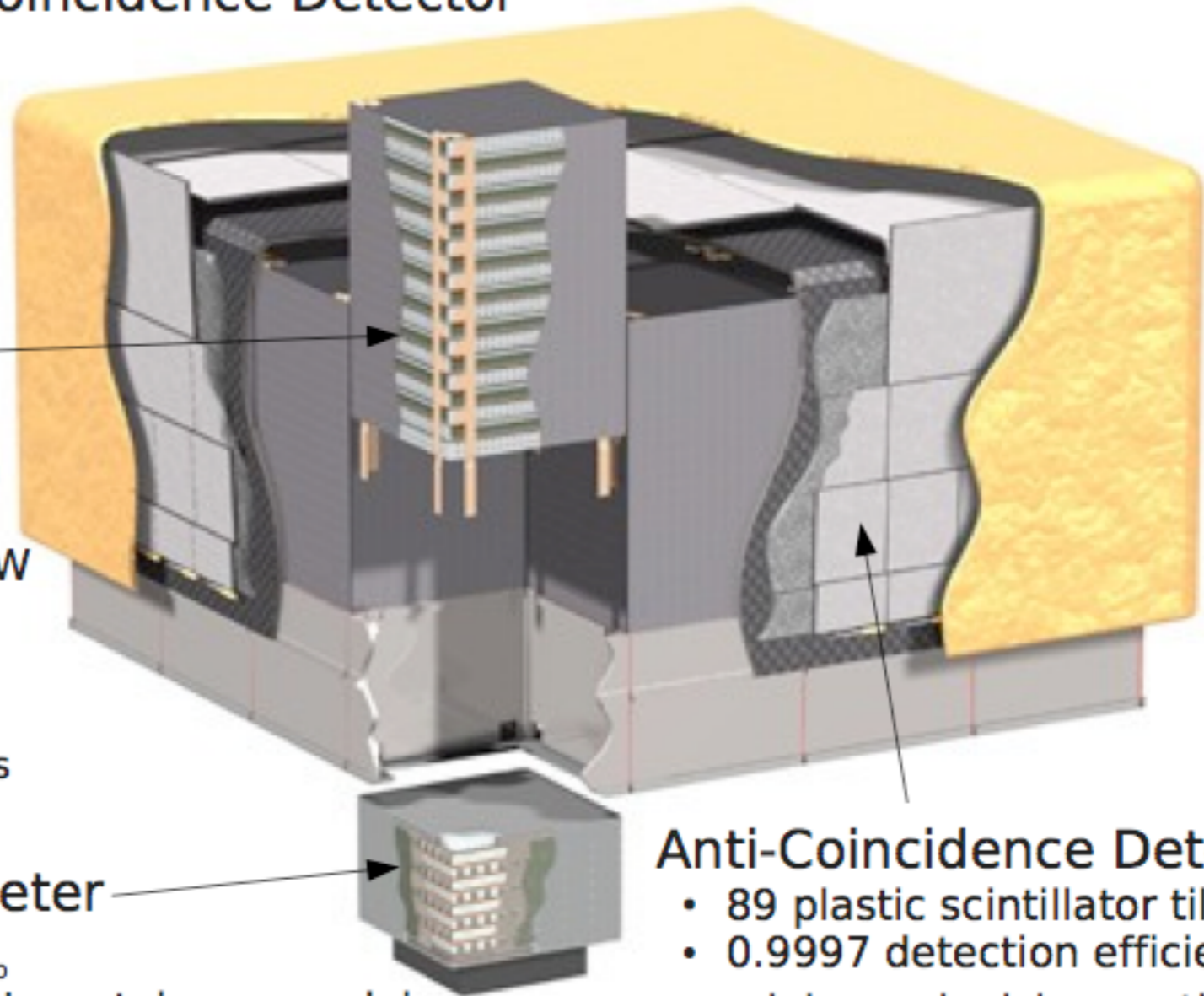

Determine the incoming direction with the tracker

Determine the energy with the tracker and the calorimeter

Check if there is some signal in the anti-coincidence detector

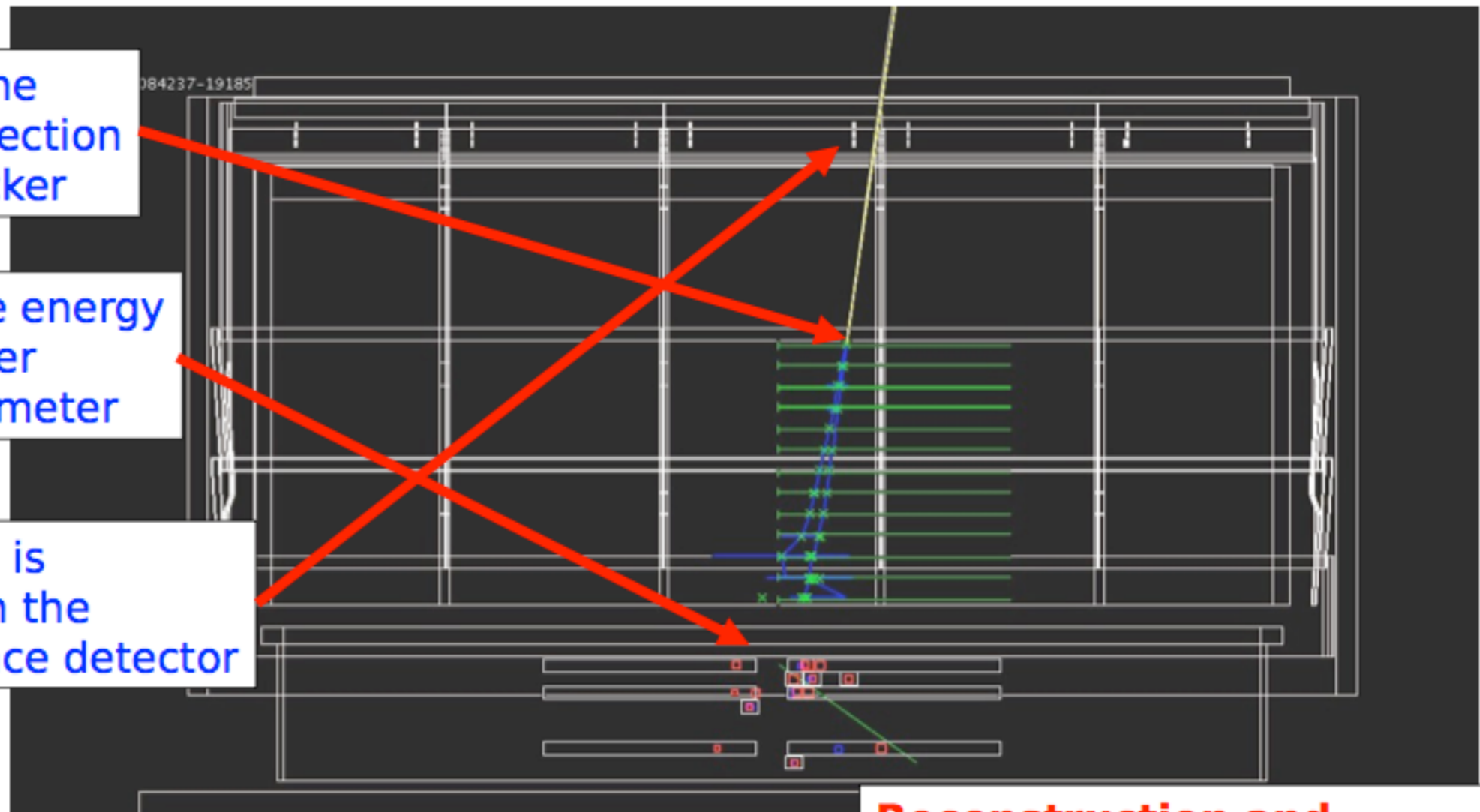

The calorimeter is used in the event selection : match between the track and the cluster (position, angle), cluster transverse size.

Reconstruction and selection are optimized using classification trees.

FERMI-LAT map of gamma-ray sources with $E > 50$ GeV

<https://arxiv.org/abs/1508.04449>

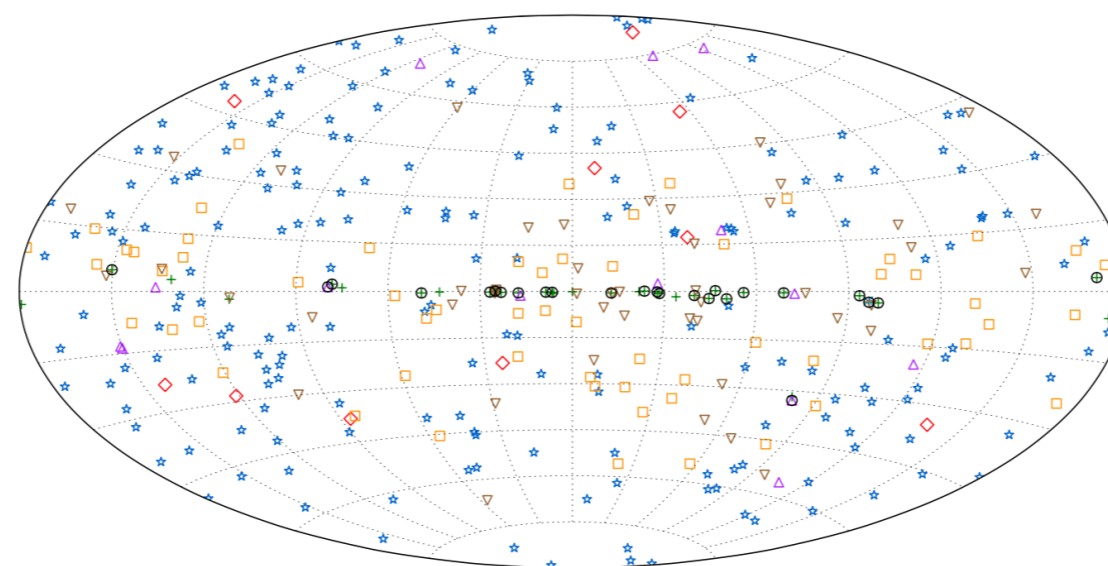
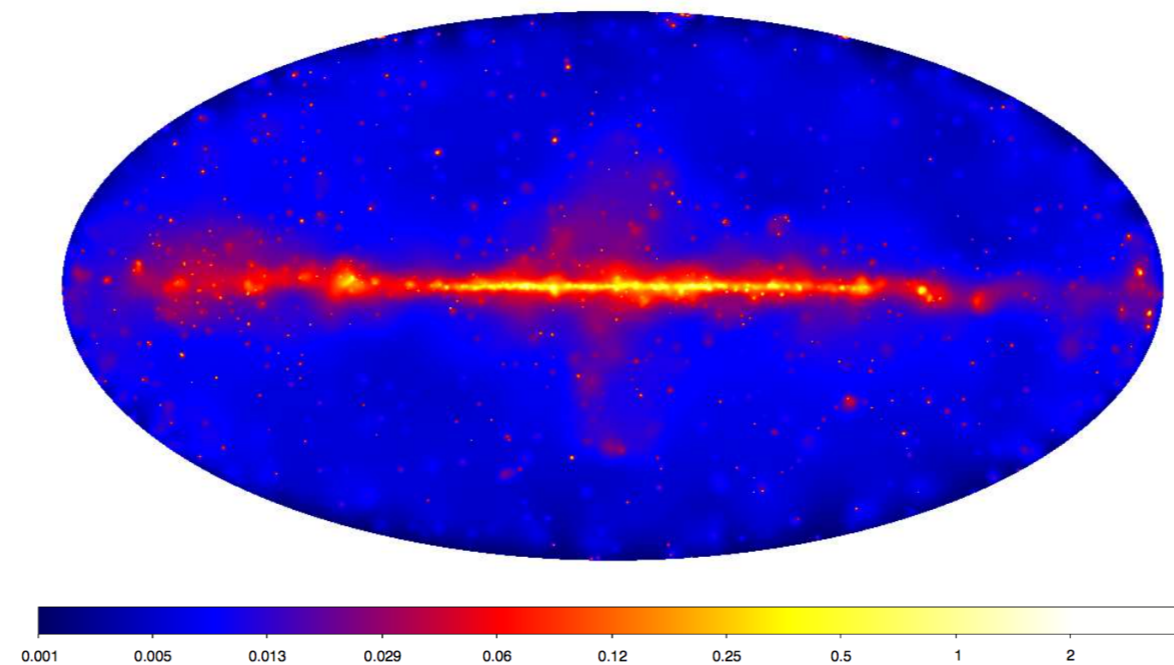

| | | | | | | | |
|---|---------------|---|---------|---|--------------|---|--------------|
| + | SNRs and PWNe | * | BL Lacs | □ | Unc. Blazars | ▽ | Unassociated |
| × | Pulsars | ◇ | FSRQs | △ | Others | ○ | Extended |

AMS: A TeV precision, multipurpose spectrometer

TRD
Identify e^+ , e^-

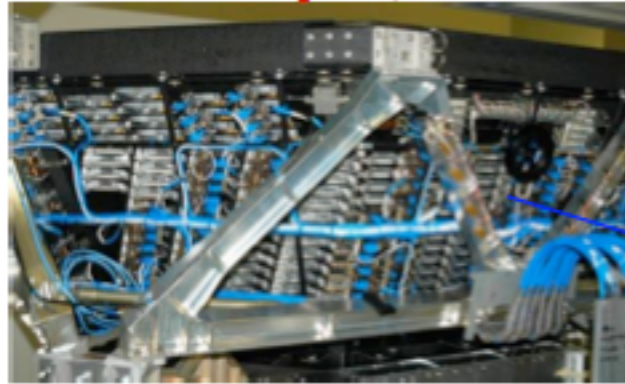

Silicon Tracker
 Z, P

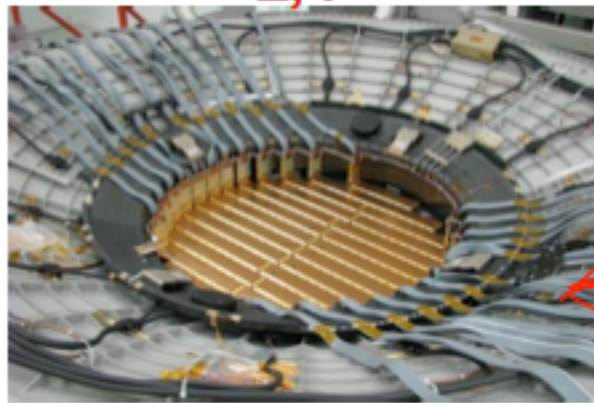

ECAL
 E of e^+ , e^- , γ

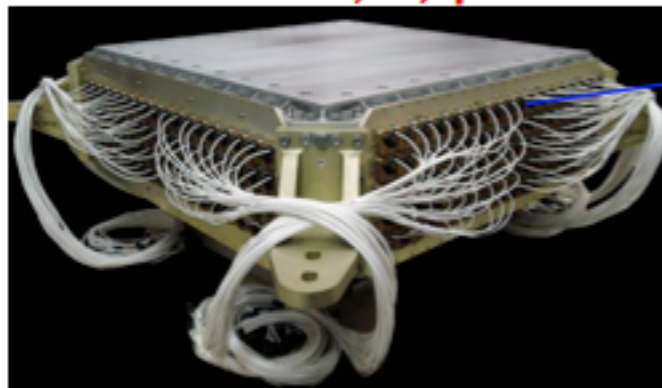

Particles and nuclei are defined by their charge (Z) and energy ($E \sim P$)

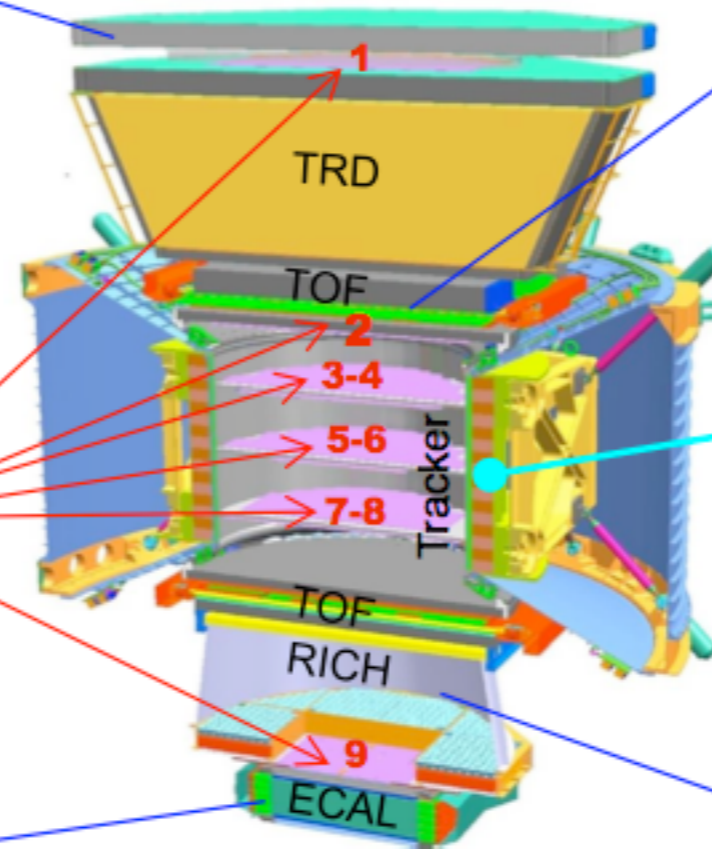

Z, P are measured independently by the Tracker, RICH, TOF and ECAL

TOF
 Z, E

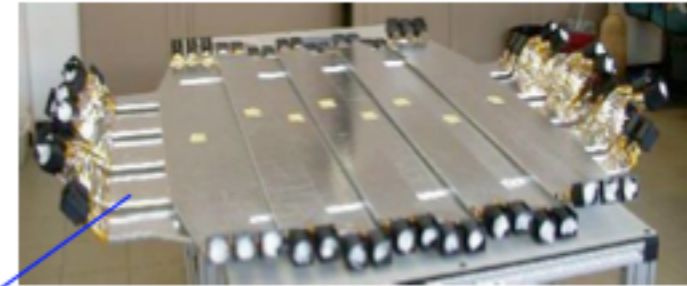

Magnet
 $\pm Z$

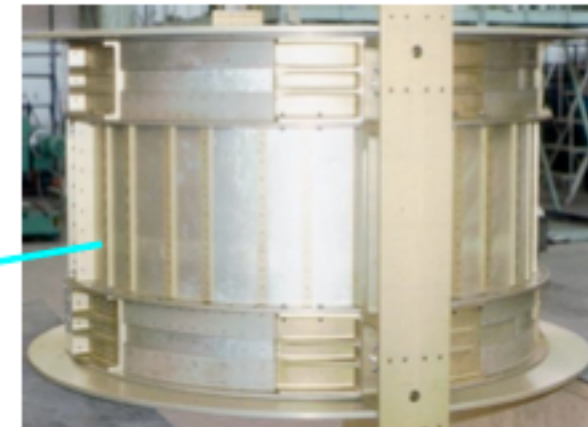

RICH
 Z, E

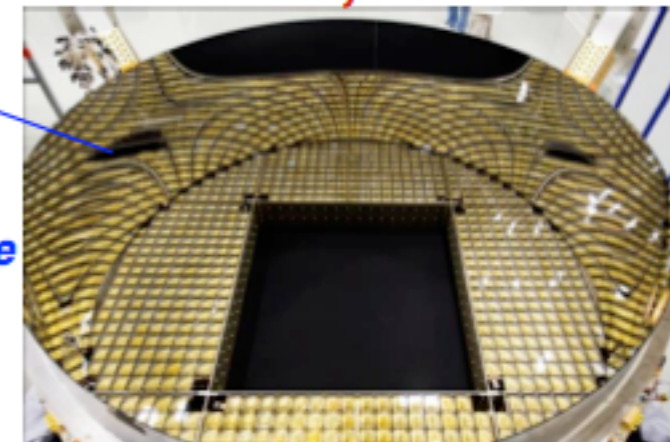

Muon identification in hadron colliders

- Muons are usually clean signatures, less background than electrons
- Main sources of «muons»
 - punch through of hadronic showers
 - pi/k decays in the inner detector
 - Semileptonic B-hadron decays => «true» non-isolated muons
 - Usually main background at high energy in collider experiments
- Precise measurement of muons requires large magnetic detectors

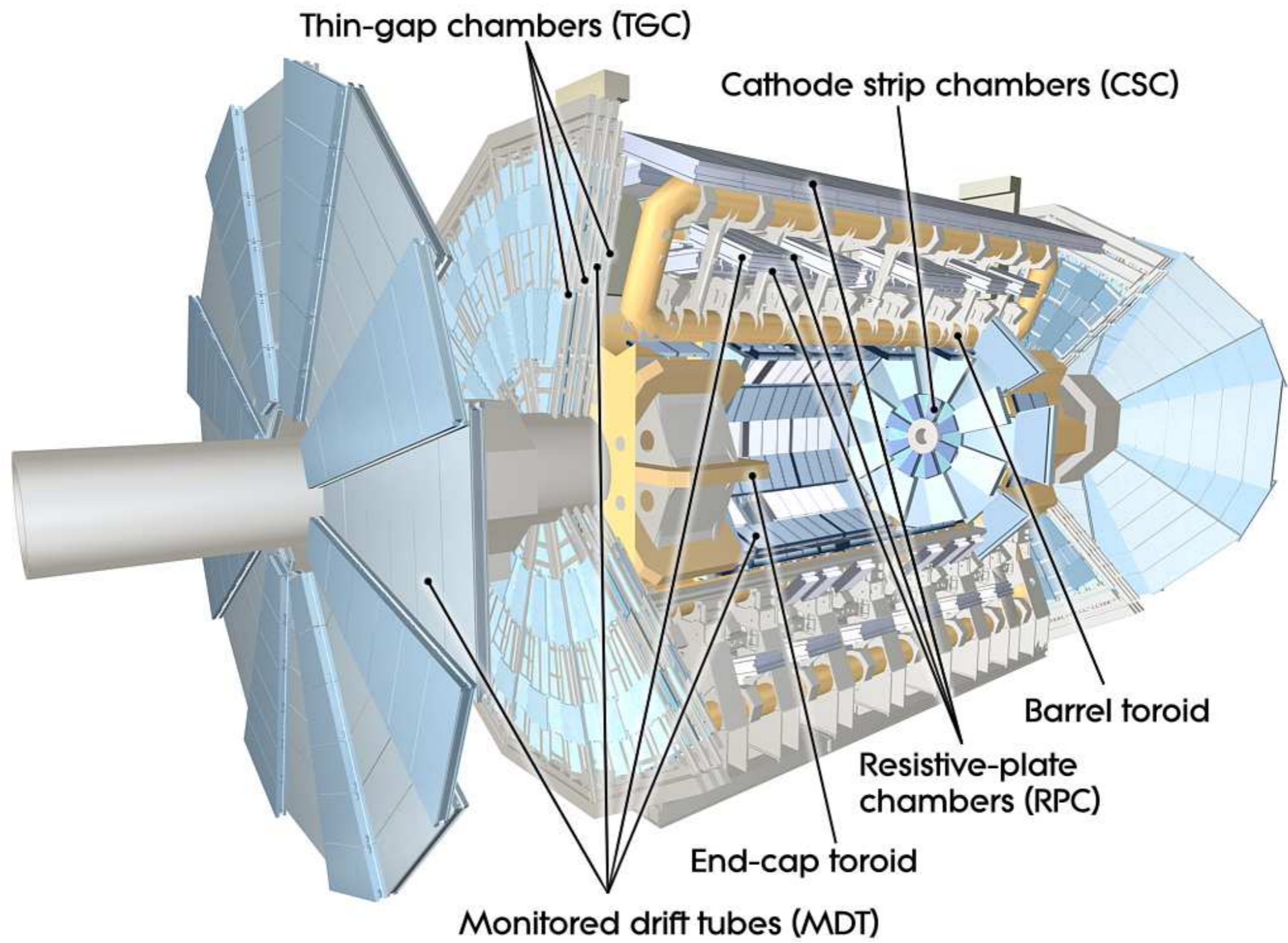

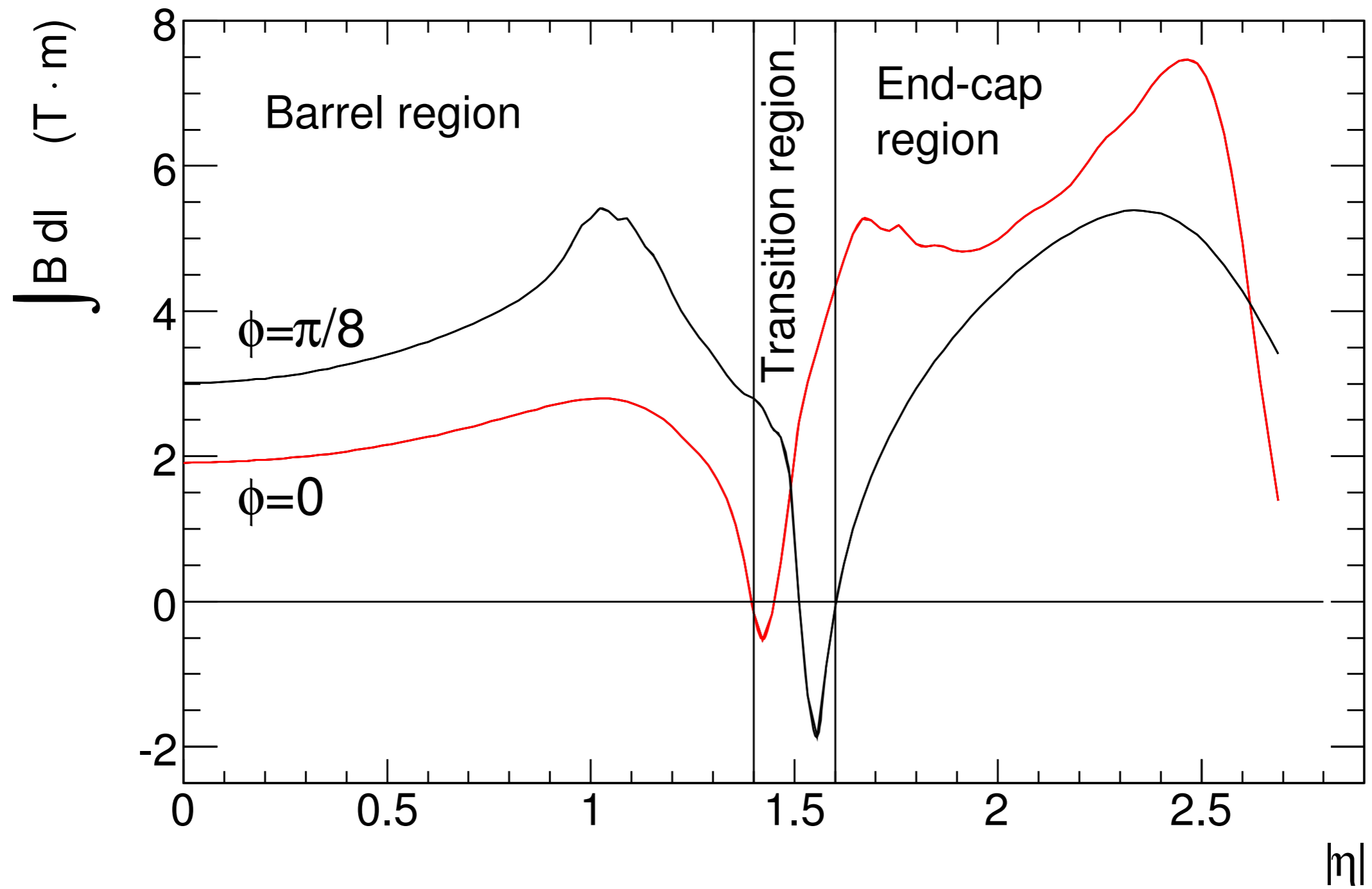

Neutrino «identification» in hadron colliders

- The probability of neutrino interaction in a collider experiment is \sim null
- How to measure something that one does not detect ?



$$\vec{p}_T(\nu) = - \sum_i \vec{p}_T(\text{seen})$$

Missing transverse momentum for W boson discovery (1983)

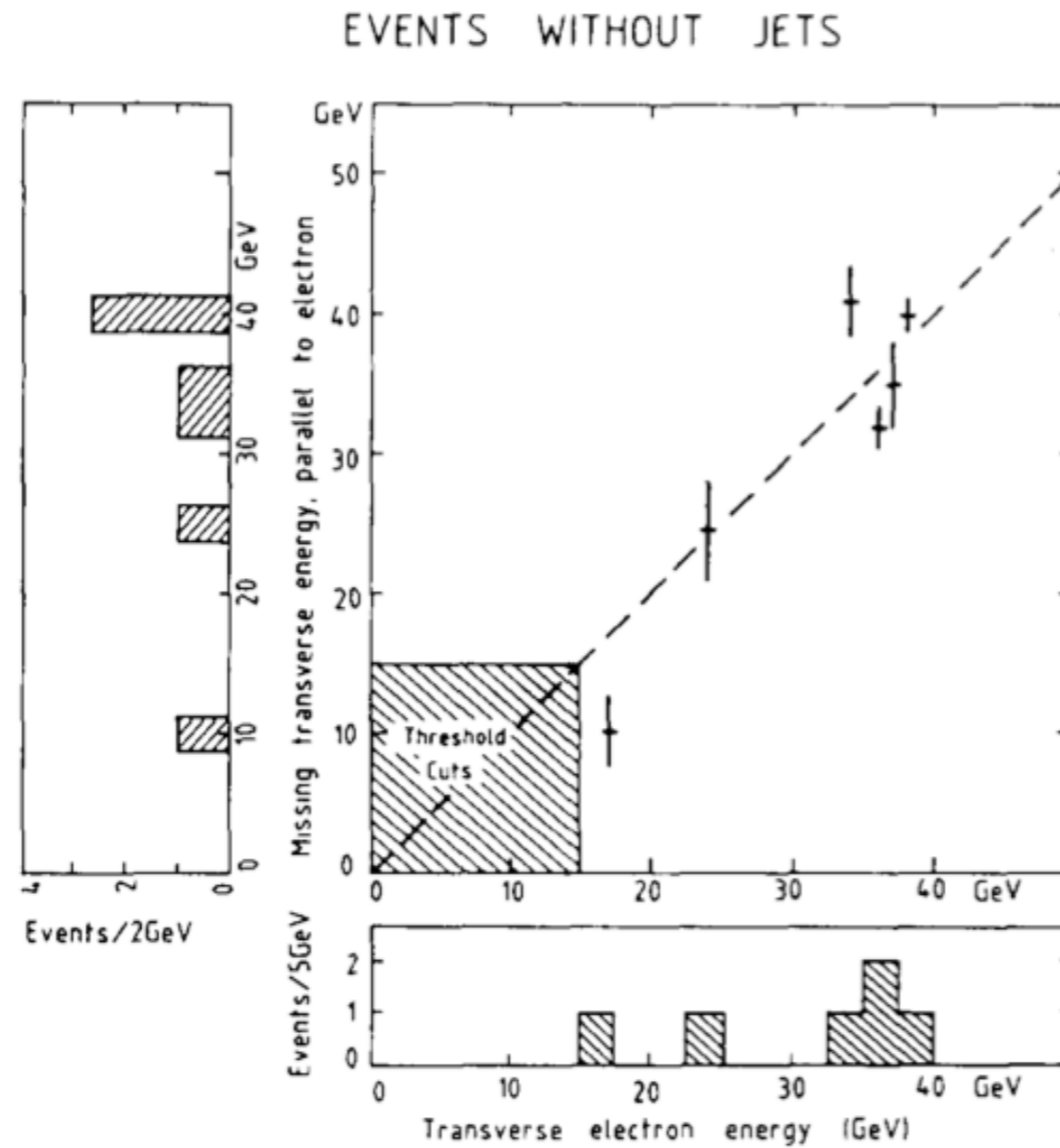

Missing transverse momentum in LHC under high pileup conditions

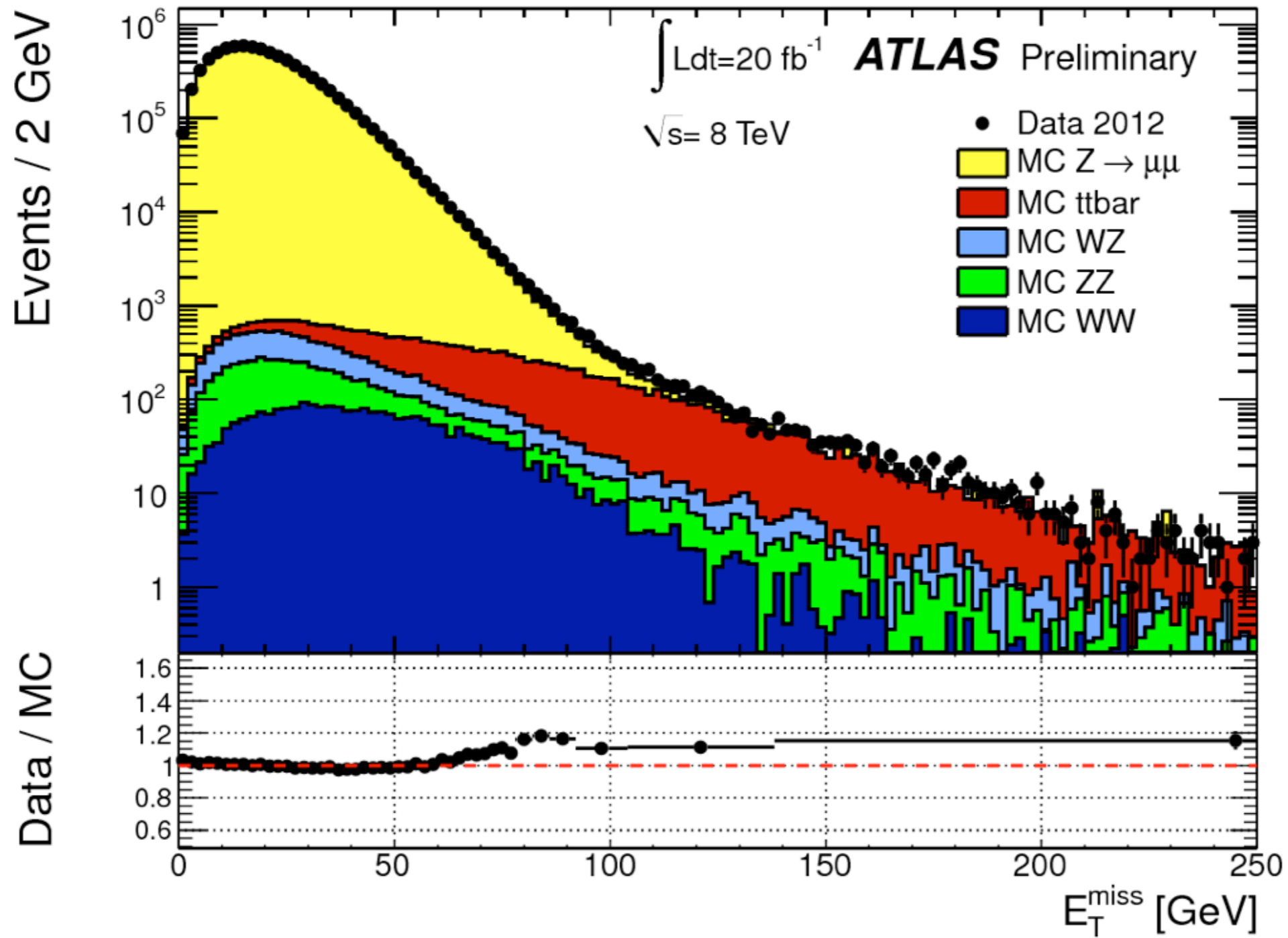

Direct detection of neutrinos

- High flux of incoming neutrinos (for instance neutrino beams)
- High mass detector
- => can observe neutrino interactions
 - Charged currents: produce e, mu or tau depending on neutrino flavor at the interaction
 - Neutral currents: ~universal for all (non-sterile) neutrinos
- Neutrino cross-section increases with energy
 - at $O(> \text{PeV})$ energy, earth becomes opaque to neutrinos

What is this event ?

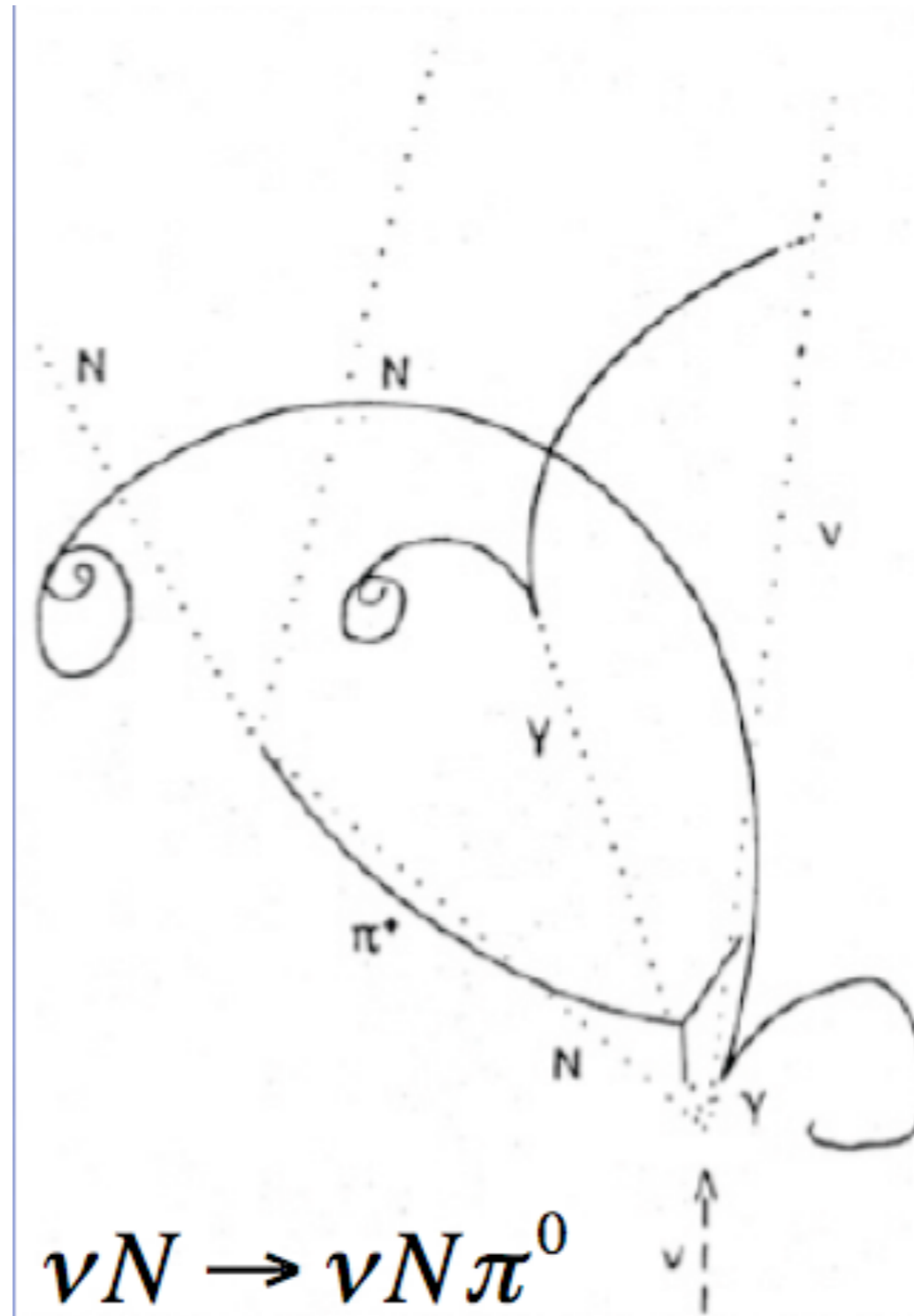

and this one ?

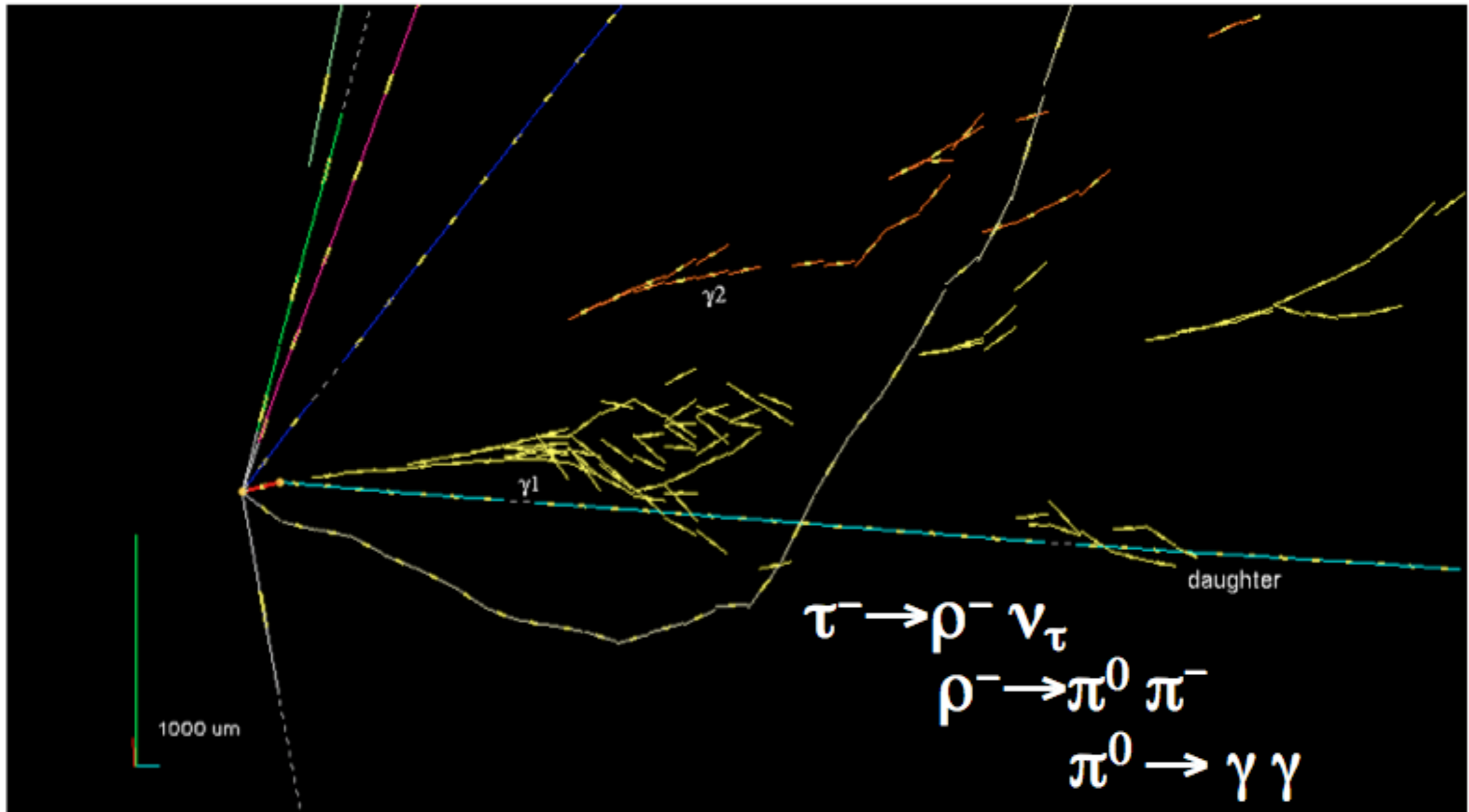

Opera experiment

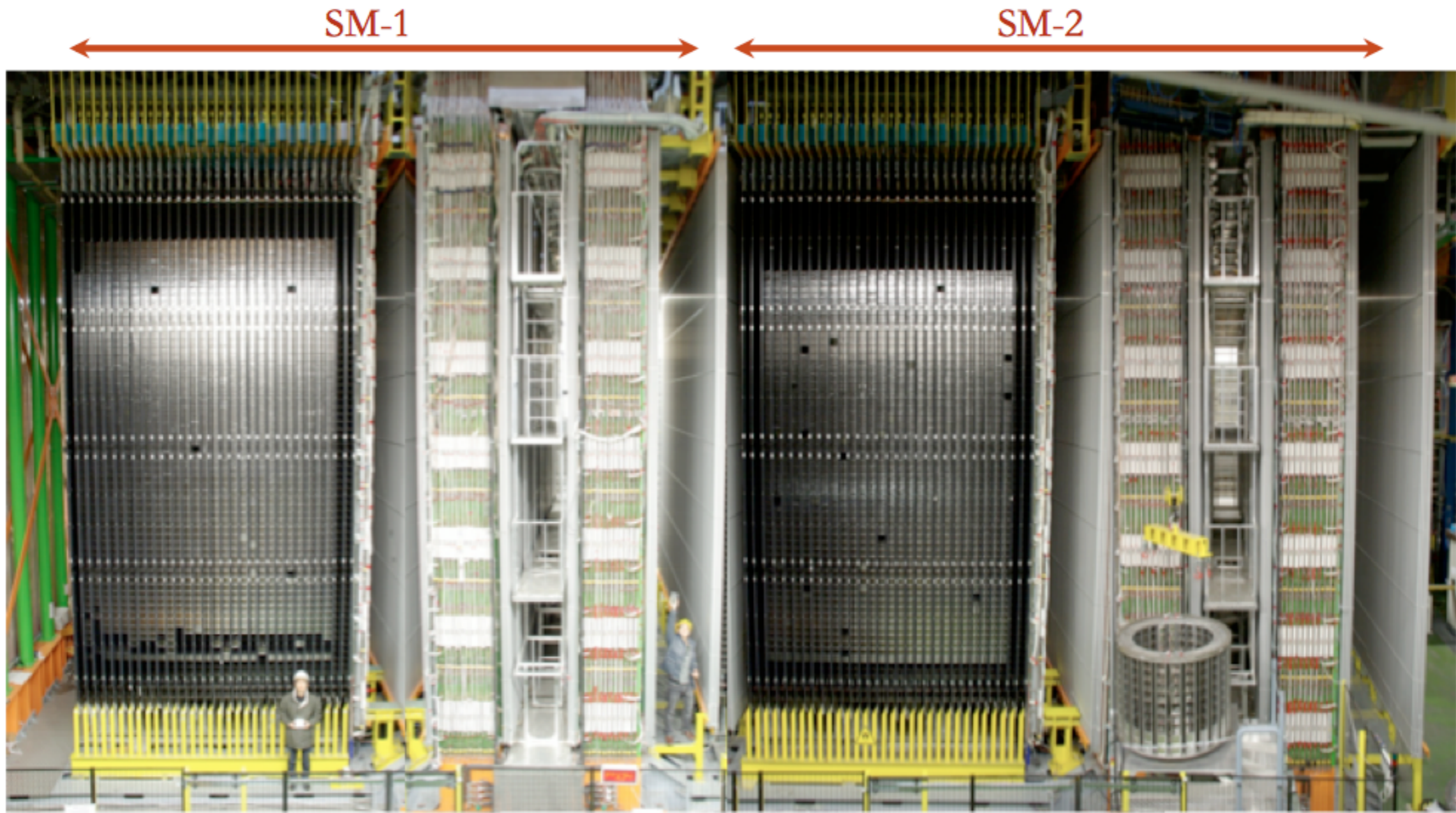

SM-1

SM-2

Target

brick walls+ Target Tracker

Spectrometer

RPC+Drift Tubes

Target

brick walls+ Target Tracker

Spectrometer

RPC+Drift Tubes

NOVA neutrino experiment

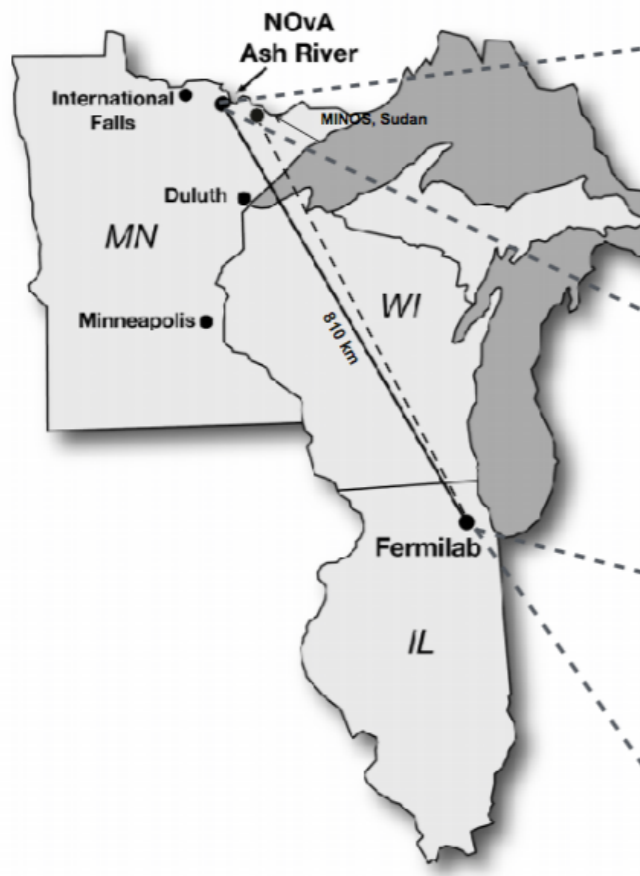

Start with muon neutrino beam
and look at rate of remaining muon neutrino
and appearing electron neutrino at a long distance

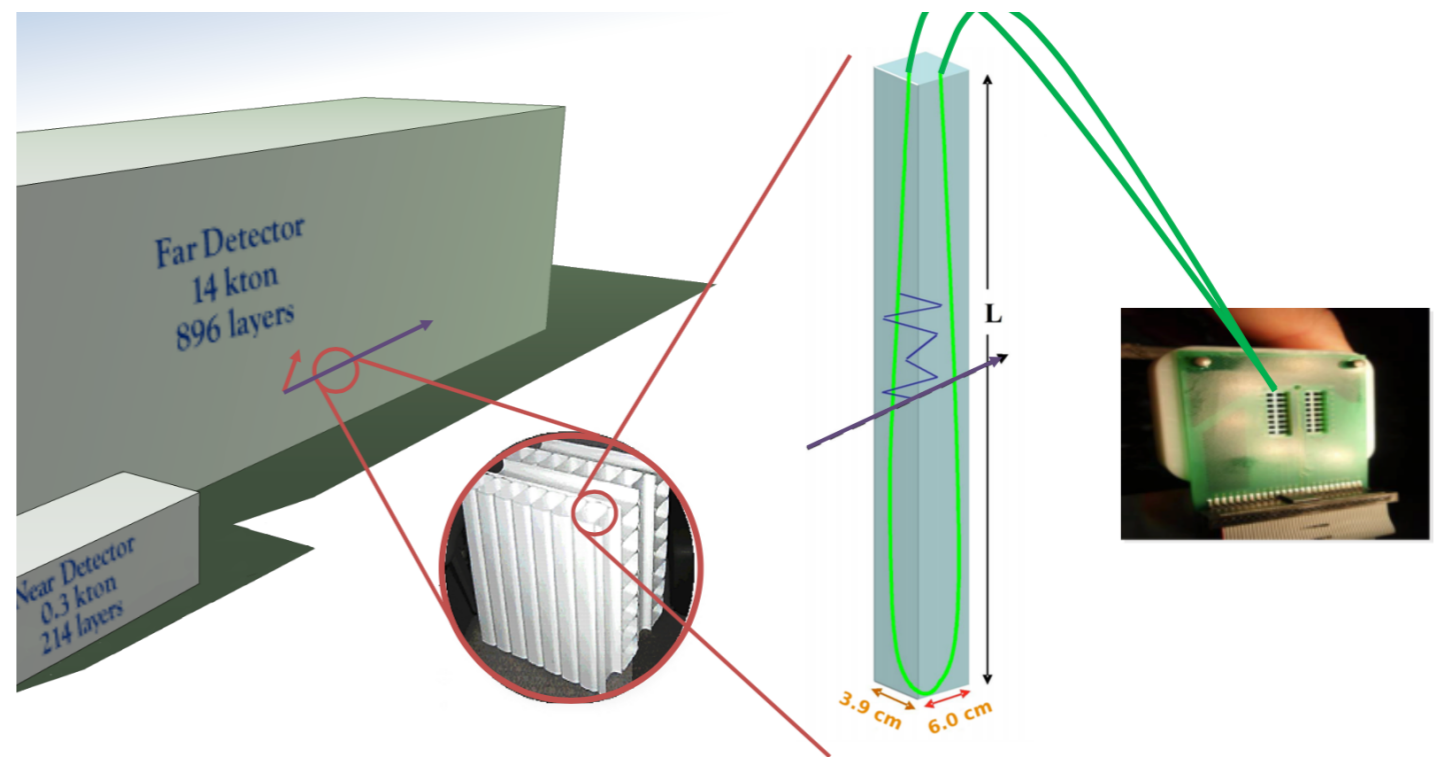

Charged current reaction used to identify flavor of interacting neutrino
=> need good identification of electrons and muons induced by neutrinos
(+ rejection of cosmic background)

Use algorithm inspired by computer vision to optimize particle identification

<https://arxiv.org/abs/1604.01444>

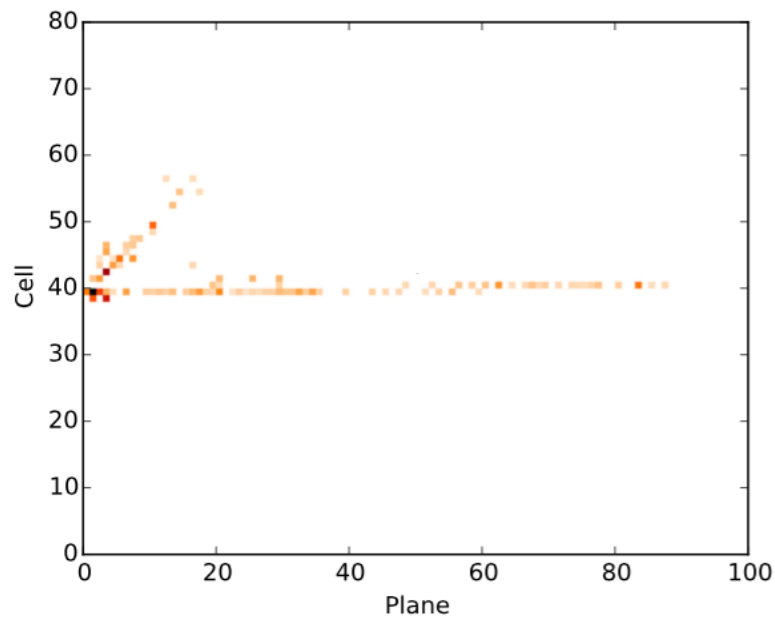

X-view

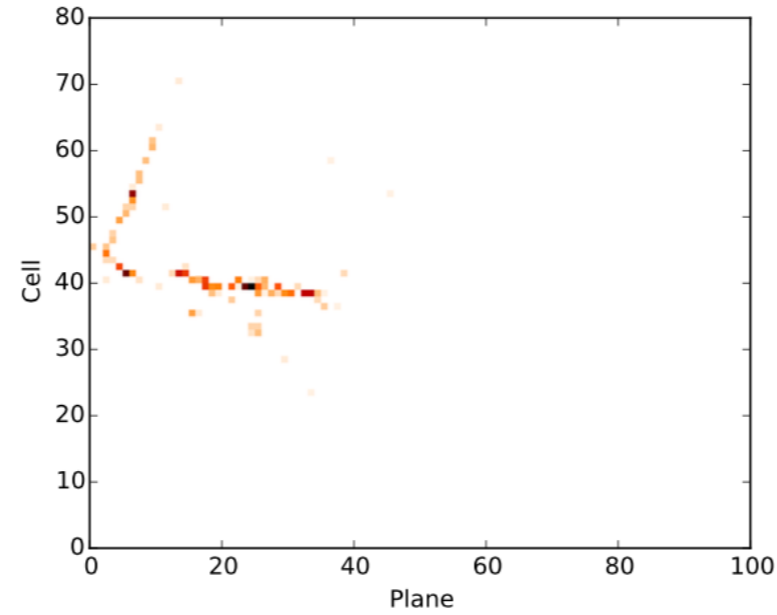

X-view

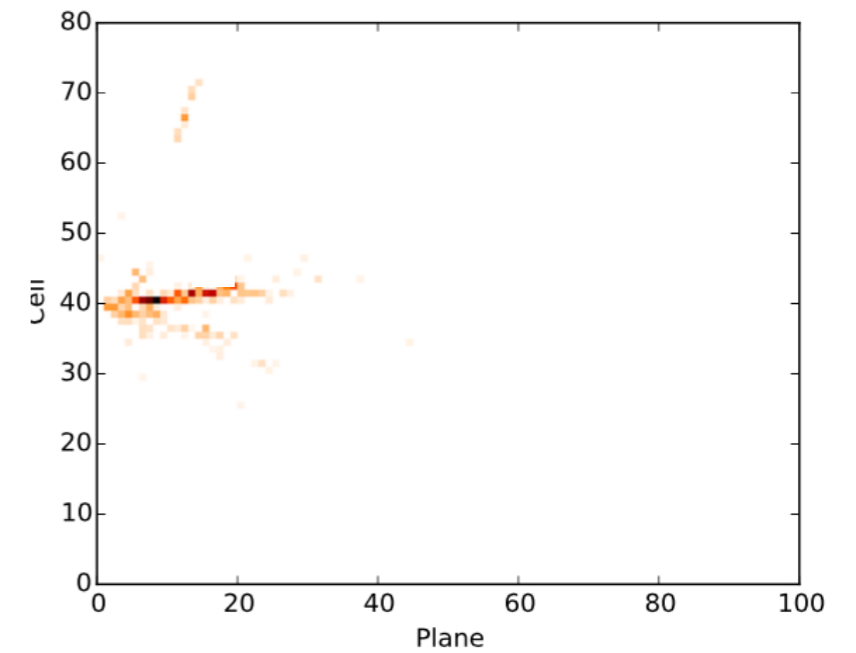

X-view

Measure beta or gamma of particle

- Direct measurement of velocity («time of flight»
 - $v = d/t$
- Measurement of beta.gamma through ionization energy loss
- Measurement of beta through Cherenkov radiation
- Measurement of gamma through Transition radiation

time of flight

$$\beta = \frac{v}{c} = \frac{L}{t \cdot c}$$

$$m = \frac{p}{c} \sqrt{\frac{c^2 t^2}{L^2} - 1}$$

$$\frac{dm}{m} = \frac{dp}{p} + \gamma^2 \left(\frac{dt}{t} + \frac{dL}{L} \right)$$

For 2 hypothesis m_A, m_B :

$$|t_A - t_B| = \frac{L c}{2p^2} |m_A^2 - m_B^2|$$

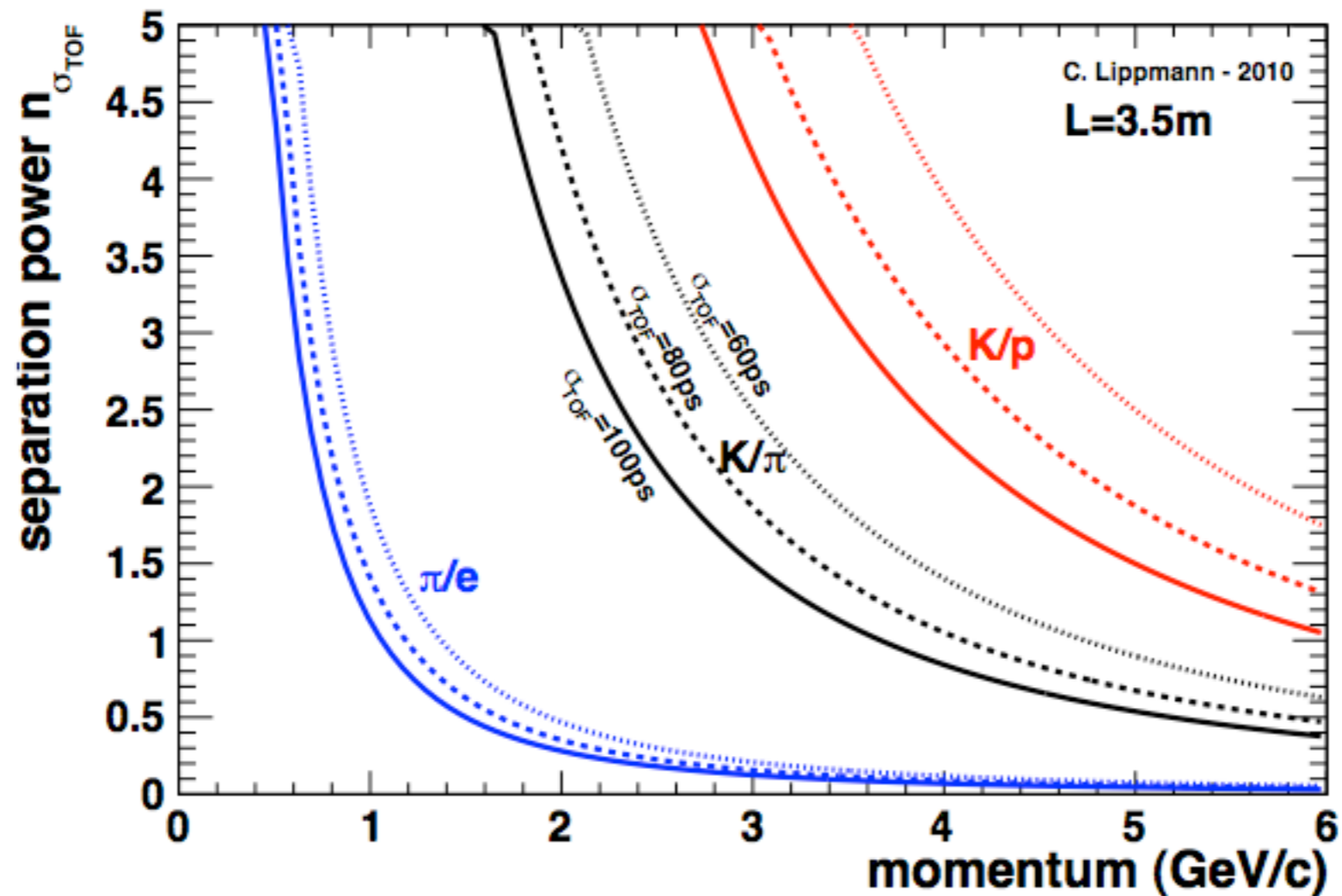

Dedicated detectors for time measurement can reach < 100 ps accuracy even on large system

At LHC, the collision time has an intrinsic jitter of ~ 140 ps (bunch length)

Need dedicated measurement to remove this contribution from time resolution

Most commonly used detectors for timing were based on scintillation
(can also use other techniques like calorimetry, etc..)

Gaseous ionization detectors like RPC developed to cover large area in a
cost-effective way

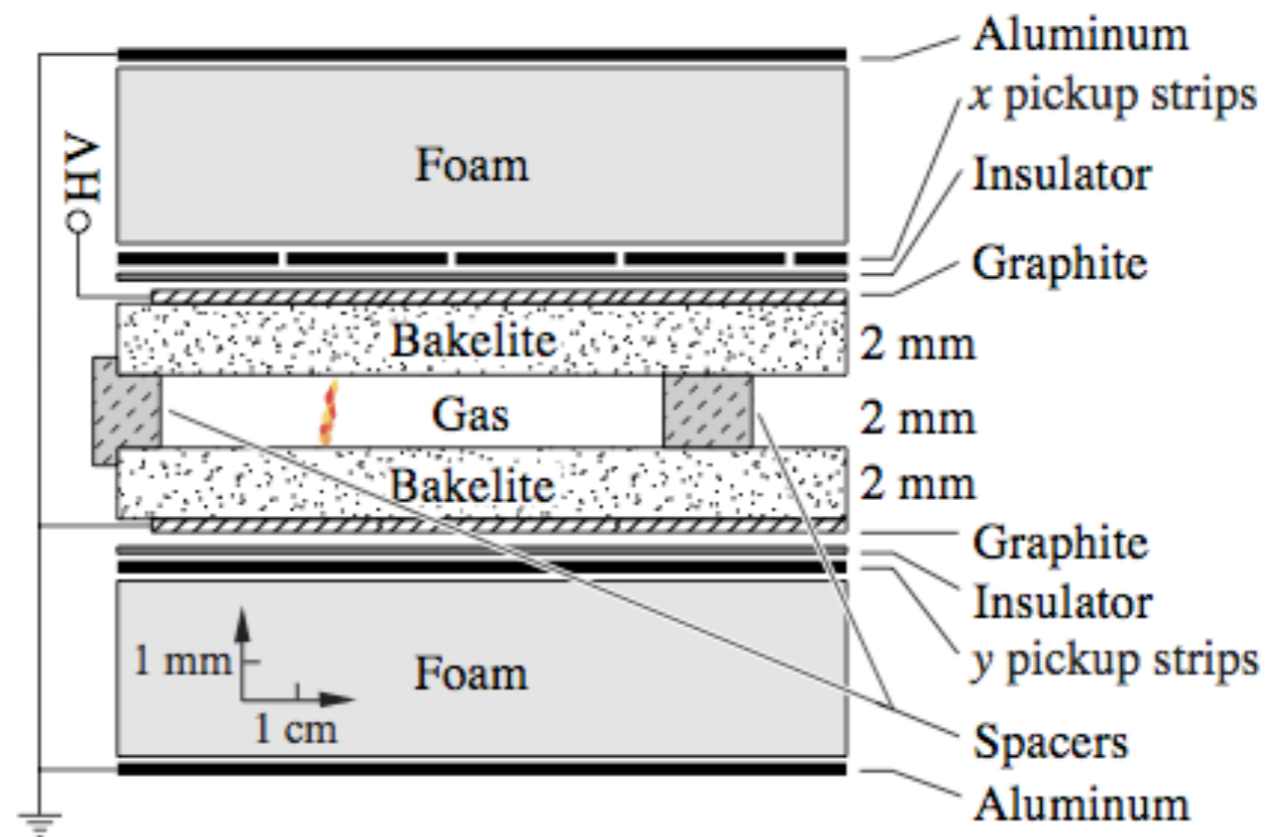

Strong uniform electric field \Rightarrow avalanche starts immediately after primary ionization
Can reach intrinsic time resolution of ~ 50 ps for multigap RPC
Rate limitation $O(\text{kHz}/\text{cm}^2)$

ALICE time of flight based on MRPC $\sim 10^5$ channels

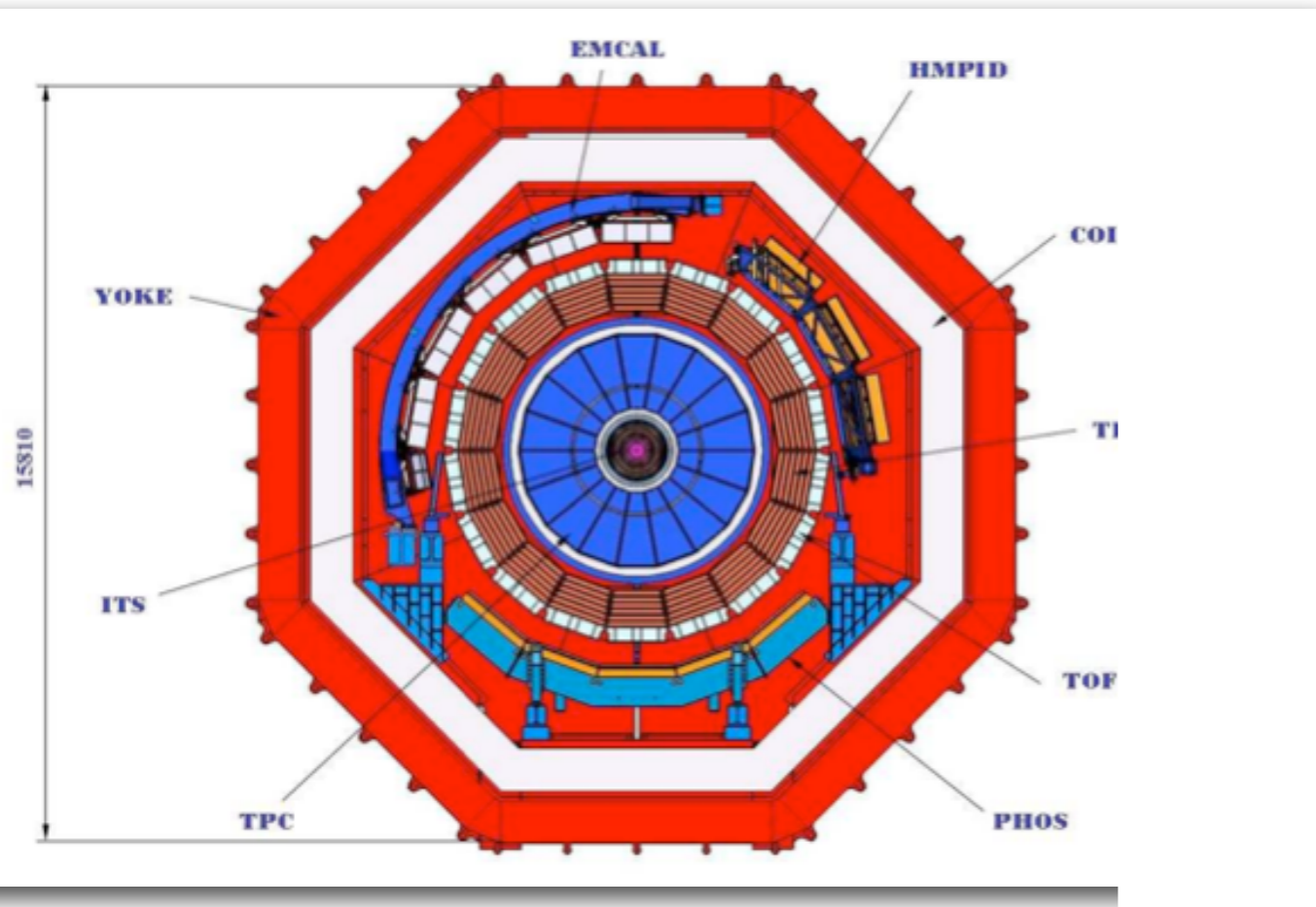

TOF @R=3.7m from interaction point

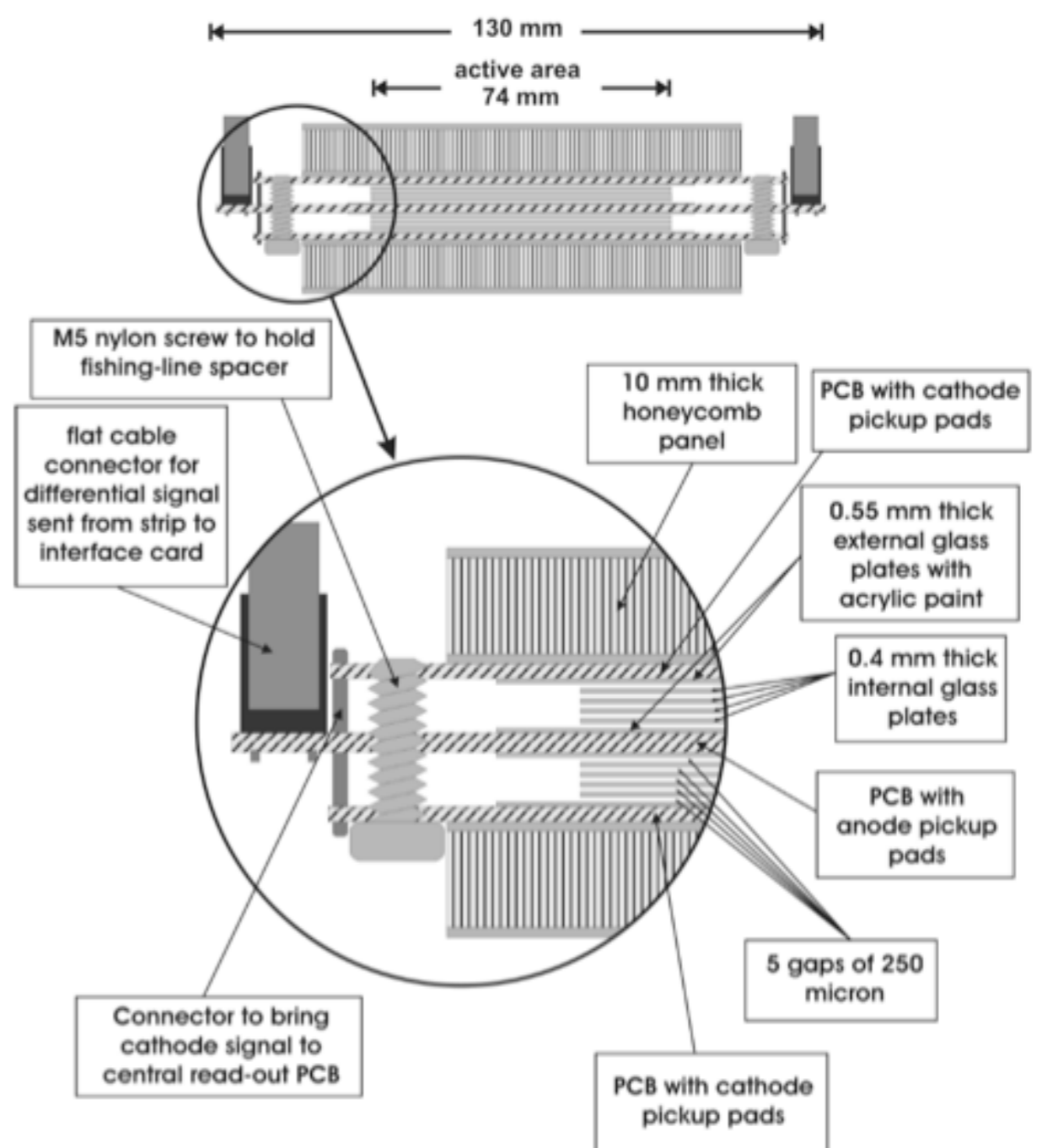

Measured time resolution in ALICE

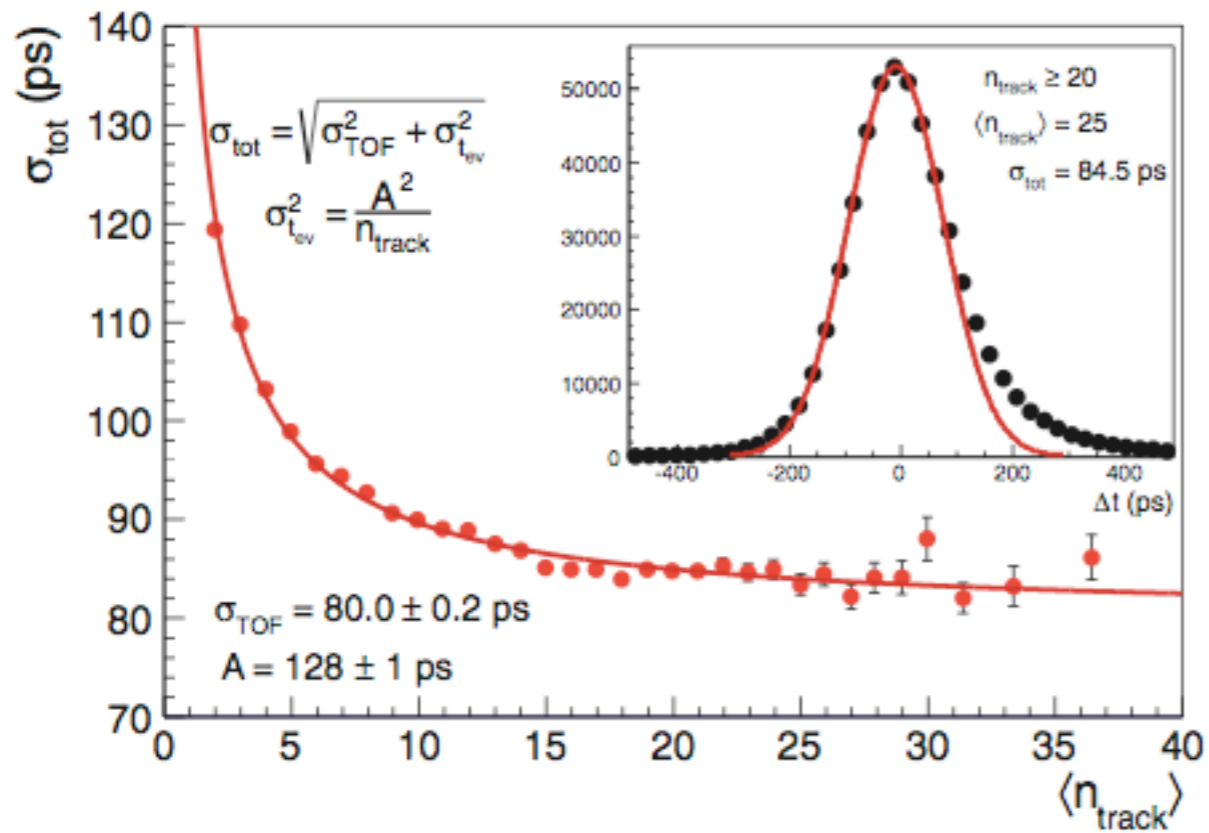

Intrinsic resolution +
 time jitters (electronics,
 clock) + channel to
 channel variation +
 residual time slewing
 effects

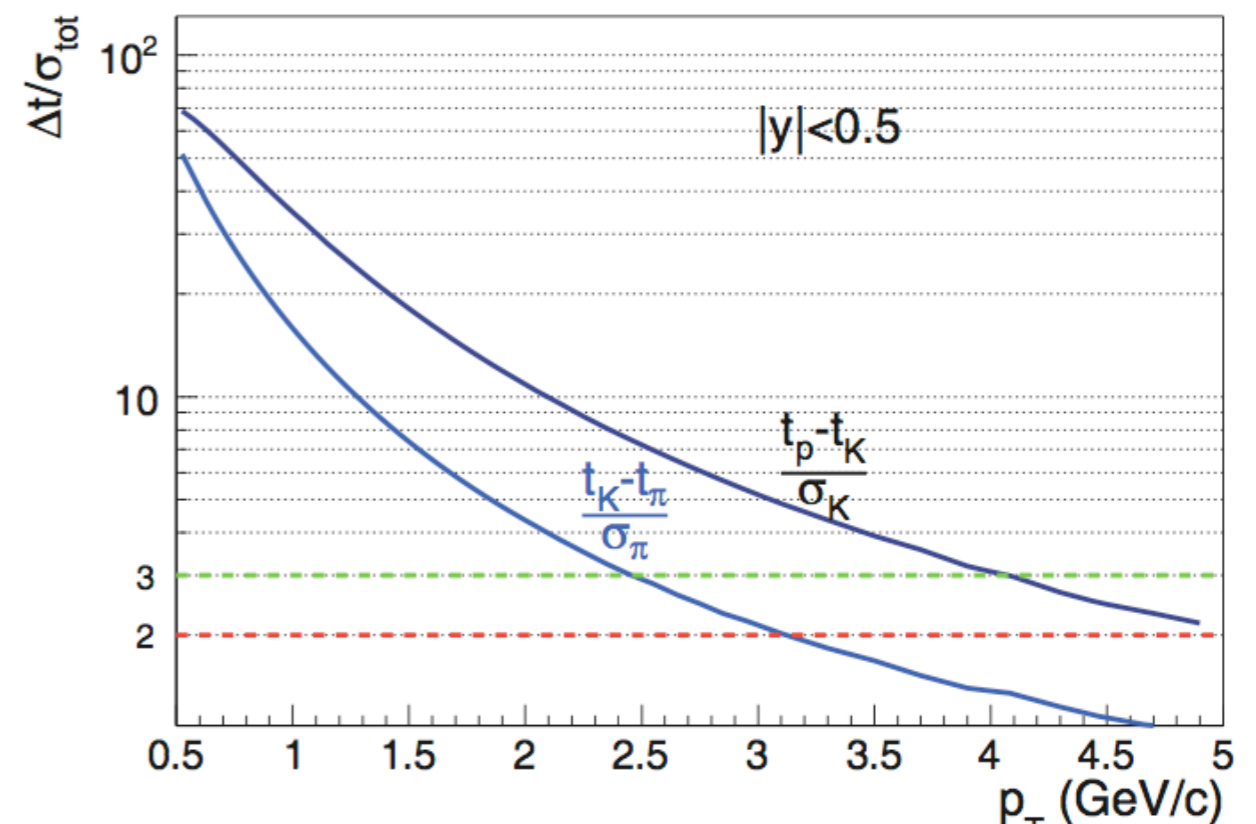
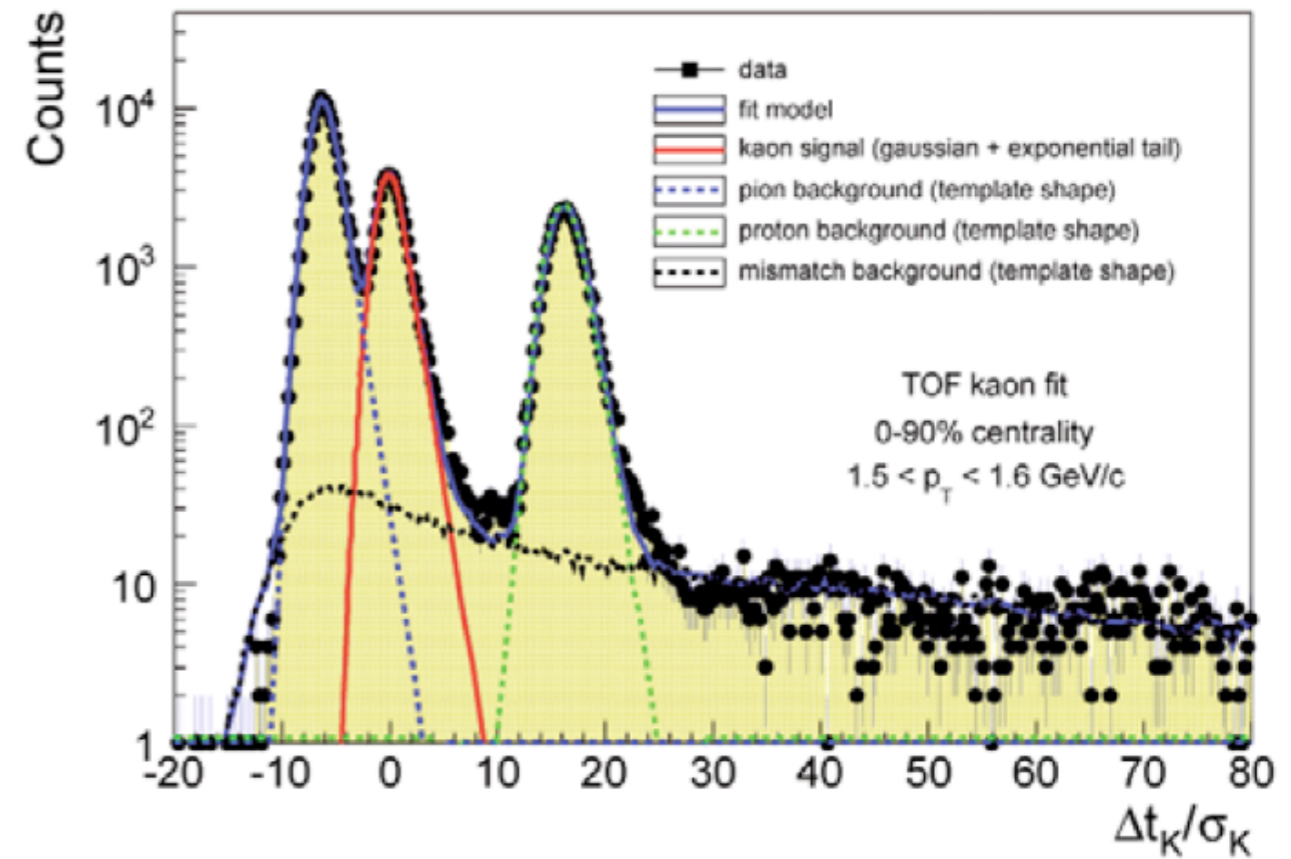

Ionization measurement

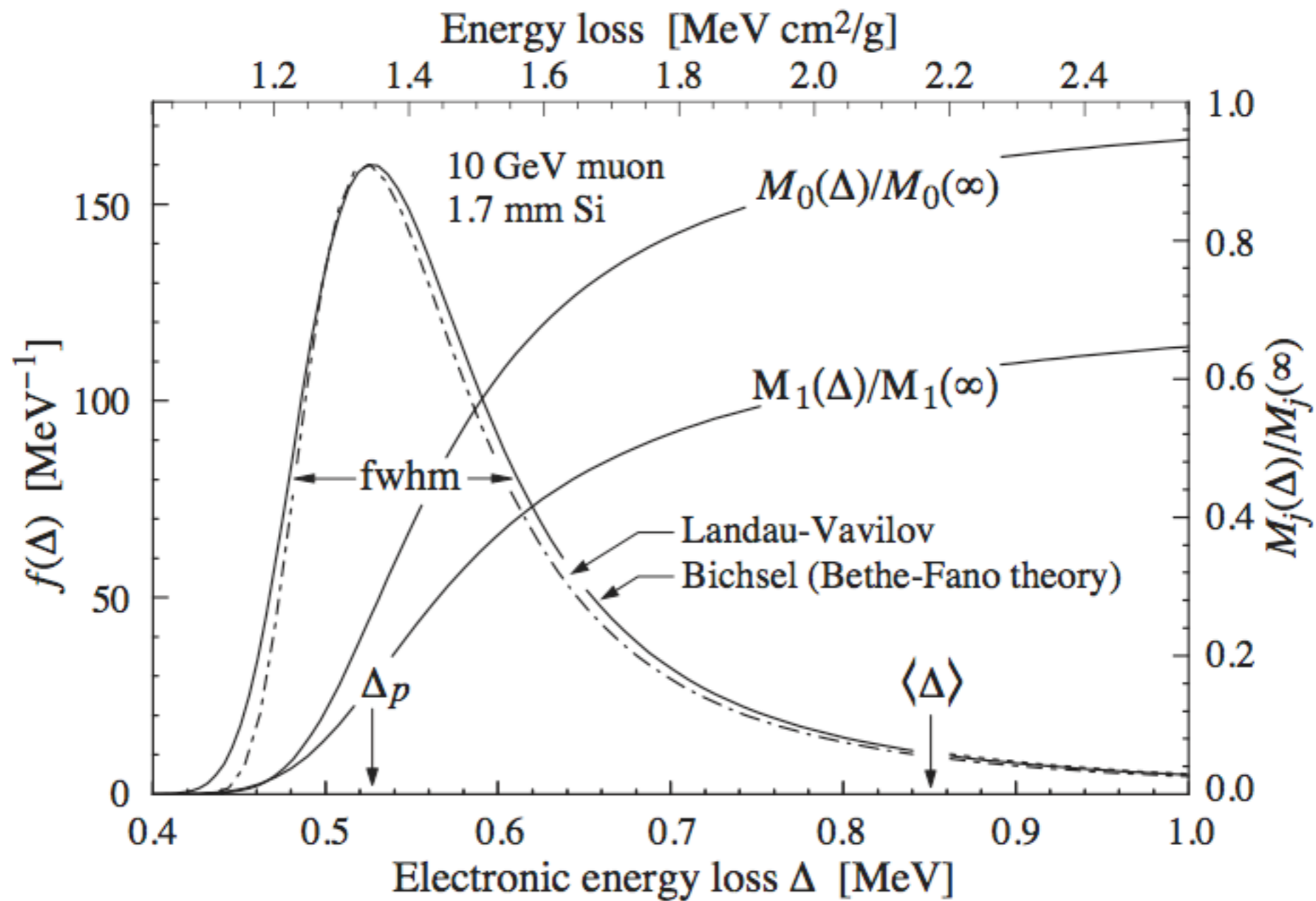

Formula for restricted energy loss

$$\left\langle \frac{dE}{dx} \right\rangle \propto \frac{z^2}{\beta^2} \left(\log \frac{\sqrt{2m_e c^2 E_{cut}} \beta \gamma}{I} - \frac{\beta^2}{2} - \frac{\delta}{2} \right)$$

I = effective excitation energy

δ = density correction effect

E_{cut} = upper limit for energy transfer in single collision

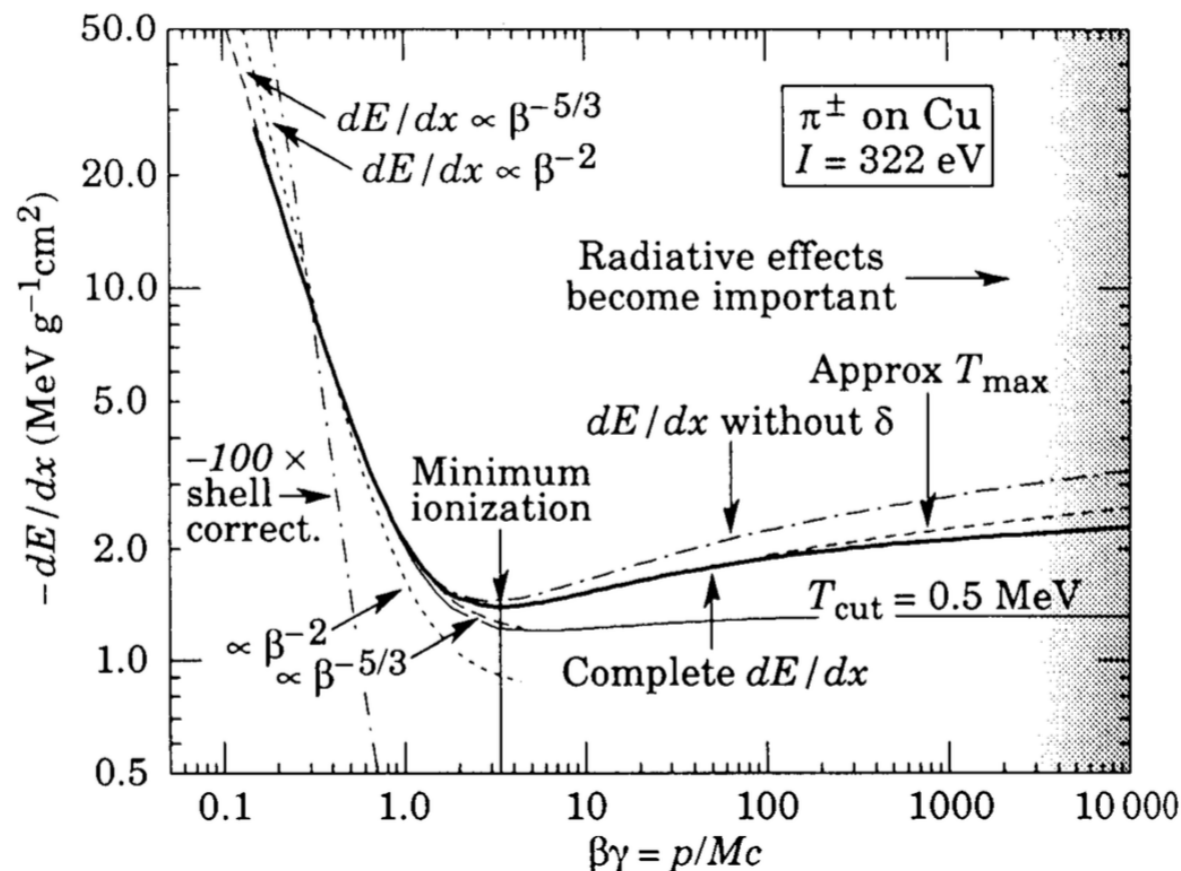

Ionisation measurement in a TPC

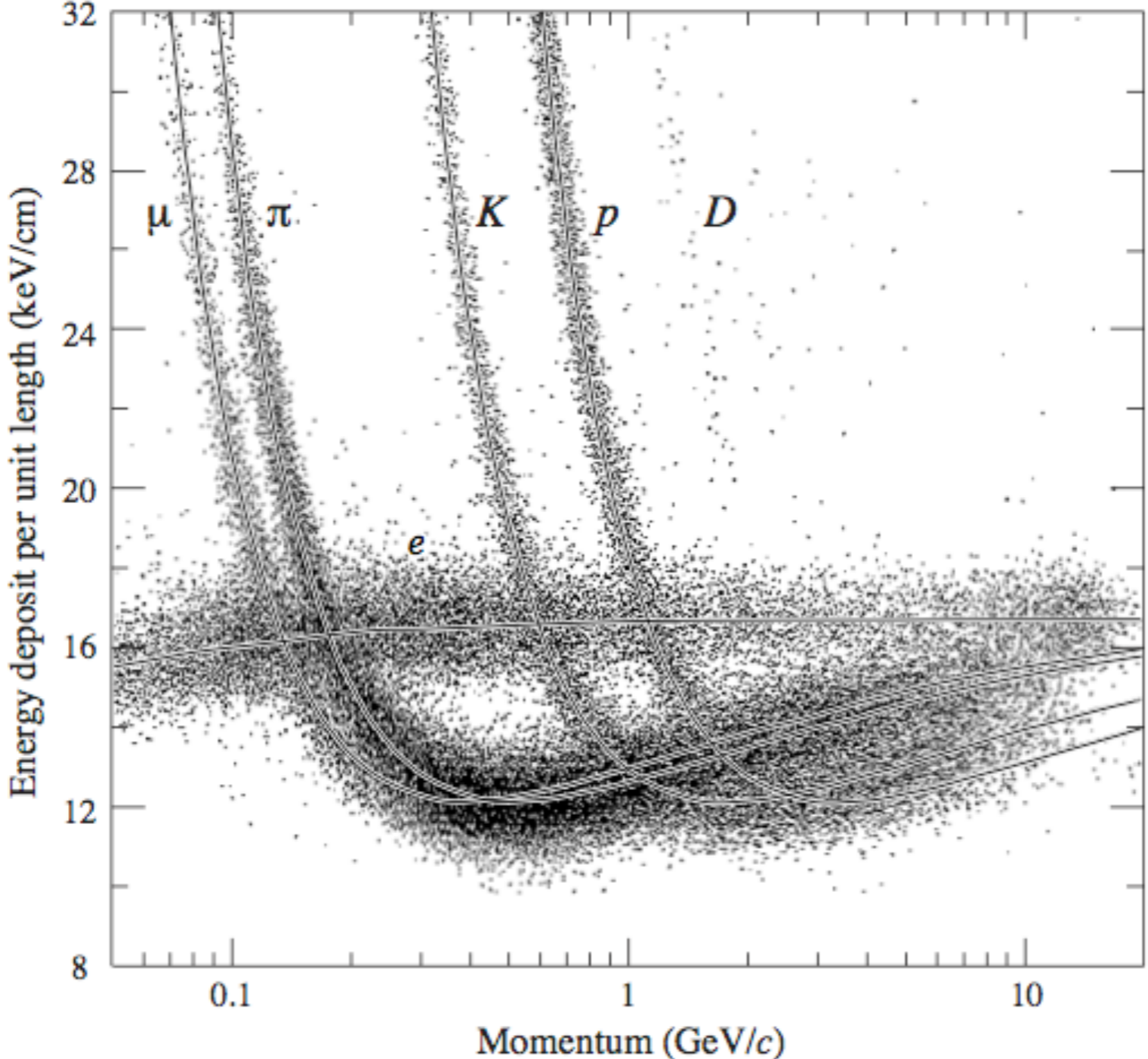

Can use gaseous or solid state counter to measure ionisation

Provide signal pulse height $\sim N$ (electrons liberated in ionization) and measurement of track length

=> allows one to compute dE/dx

Average several measurements with a truncated mean to reduce tail impact

Typical other errors affecting measurement:

- energy calibration of the detector
- detector conditions (for instance gas pressure)
- detector geometry and track orientation (affects track length)
- overlapping tracks in dense environment
- etc..

Typical ionization signals vs p (gaseous detector)
 (for Si detector, plateau only slightly above
 minimum => less separation at high energy)

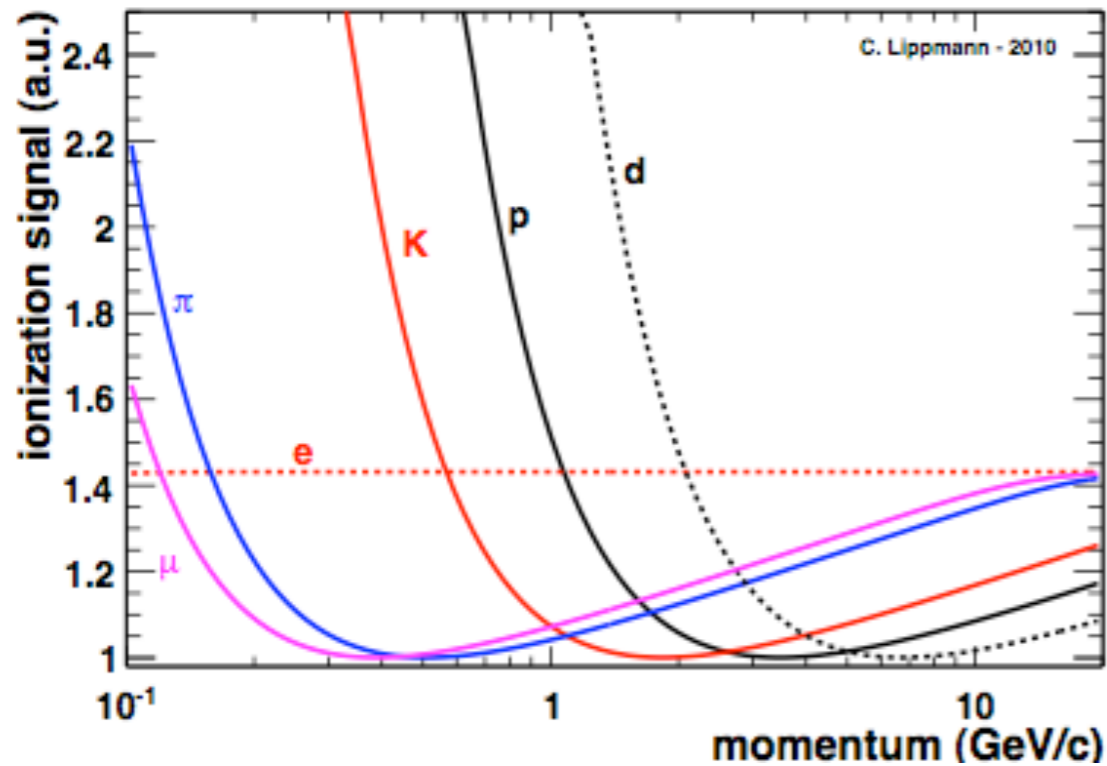

Separation assuming 5% resolution

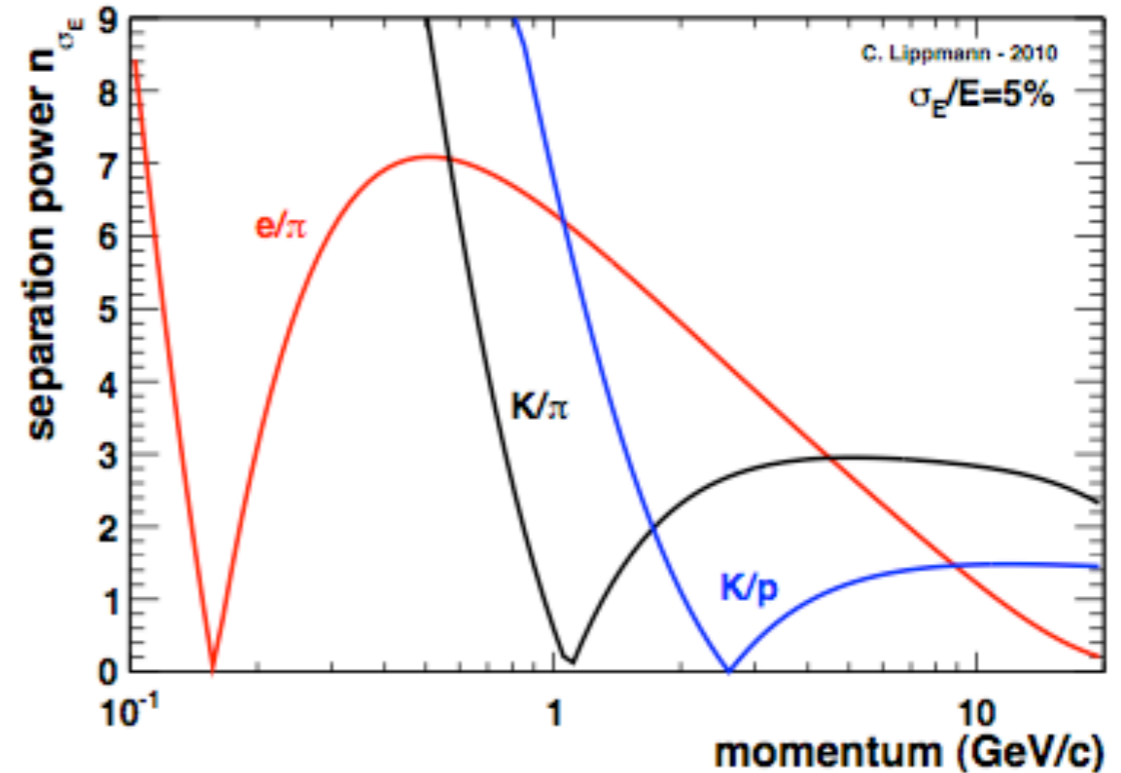

Empirical scaling formula for resolution in gaseous detector:

$$\sigma_E = 0.41 N_R^{-0.43} (xP)^{-0.32} .$$

Nr = number of measurements
 x = thickness of sampling layers
 (x.Nr = total detector thickness)
 P = pressure

ALICE TPC detector reaches $\sim 5\%$ dEdx resolution

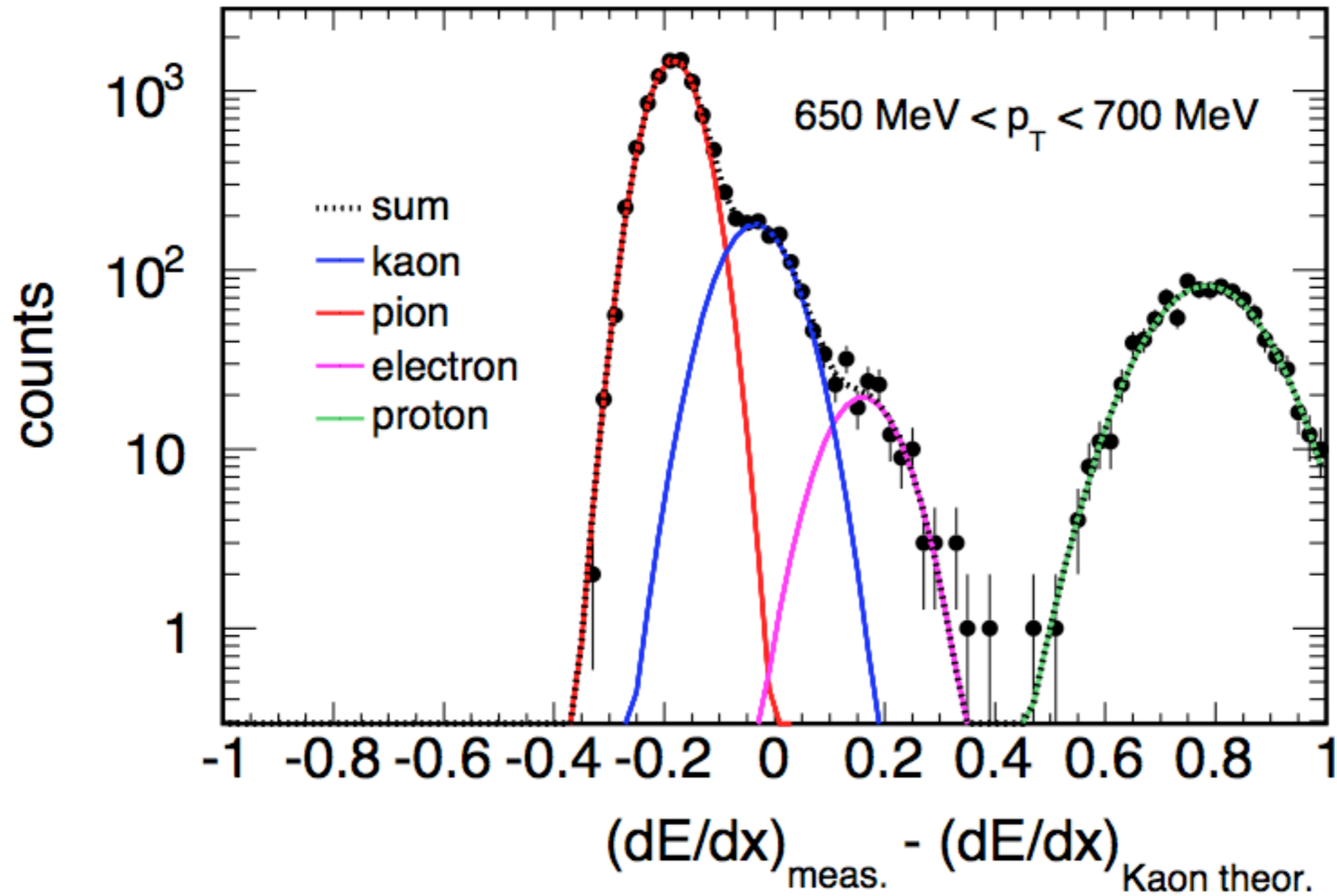

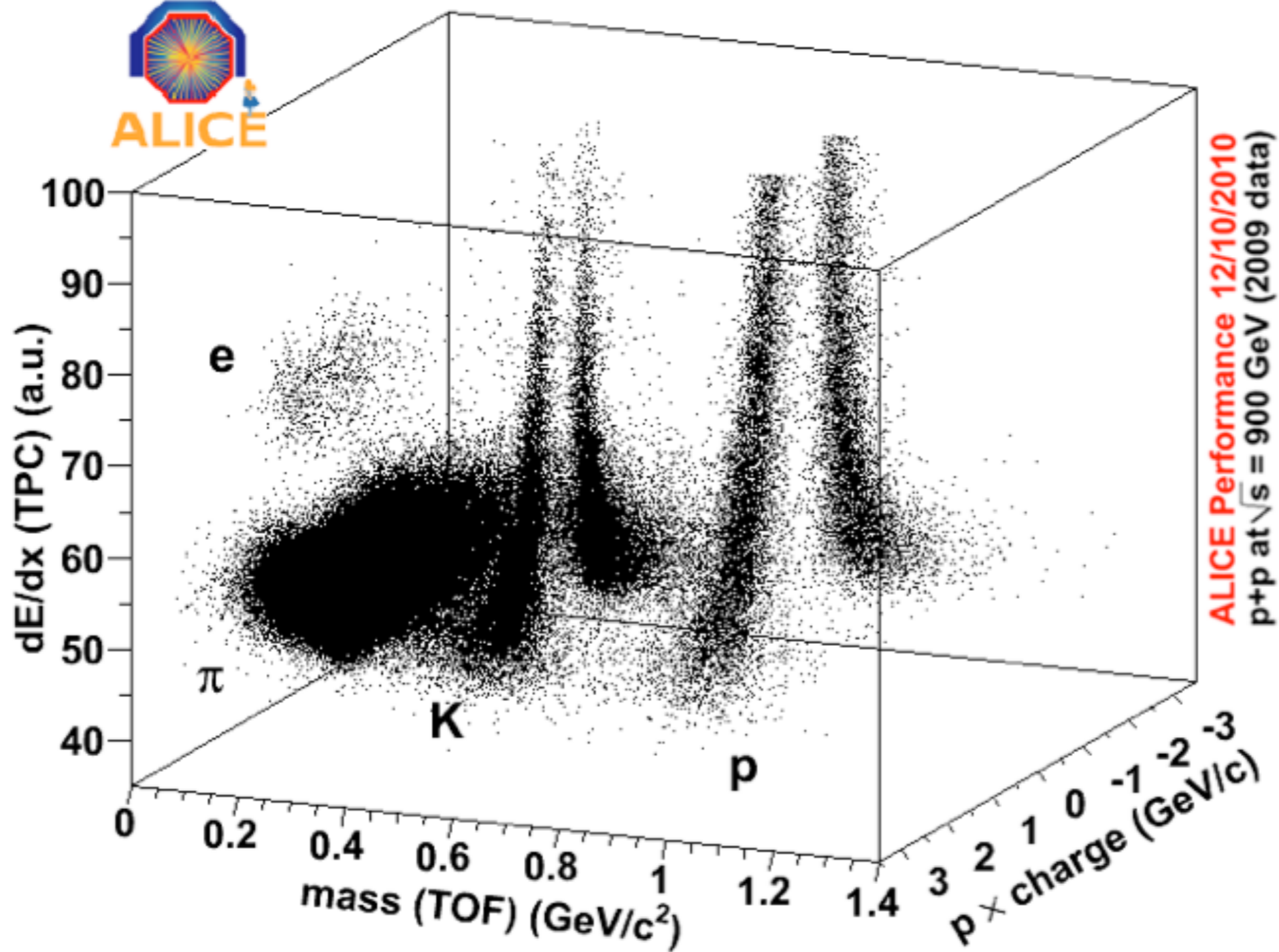

ALICE Performance 12/10/2010
p+p at $\sqrt{s} = 900$ GeV (2009 data)

Cherenkov radiation

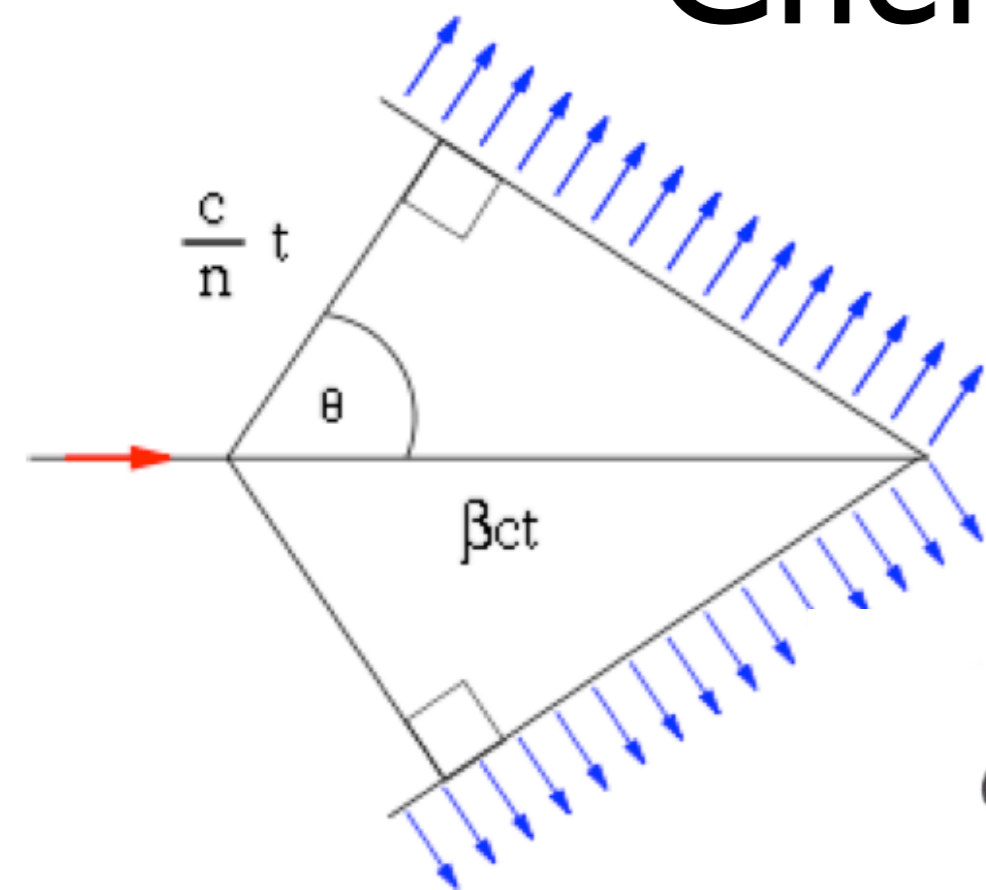

$$\cos \theta_c = \frac{1}{\beta n} \quad (n = n(E_{\text{photon}}))$$

$$\text{Threshold velocity} \quad \beta_c = \frac{1}{n}$$

$$\frac{d^2 N_\gamma}{dE dx} = \frac{\alpha z^2}{\hbar c} \sin^2 \theta_c \quad \text{or} \quad \frac{d^2 N}{d\lambda dx} \propto \frac{1}{\lambda^2}$$

$$\approx 370 \sin^2 \theta_c(E) \text{ eV}^{-1} \text{ cm}^{-1} \quad \text{for } z=1$$

different type of Cherenkov detectors

- threshold Cherenkov detectors: yes/no decision depending if particle is above/below threshold $\beta = 1/n$
 - main issue is optimising photon detection and minimising noise
- Imaging Cherenkov detectors

$$\frac{\sigma_\beta}{\beta} = \tan \theta_c \sigma(\theta_c)$$

$$\text{with } \sigma(\theta_c) = \frac{\langle \sigma(\theta_i) \rangle}{\sqrt{N_{p.e}}} \oplus C$$

$$\left\{ \begin{array}{l} \langle \sigma(\theta_i) \rangle = \text{average single photoelectron resolution} \\ \quad (\text{optics, detector geometry, ...}) \\ N_{p.e} = \text{number of photoelectron detected} \\ C = \text{alignment, multiple scattering, ambiguities} \\ \quad \text{background, etc..} \end{array} \right.$$

$$N_{\text{sigma}} \propto \frac{|m_1^2 - m_2^2|}{2p^2 \sigma(\theta_c) \sqrt{n^2 - 1}}$$

Cherenkov imaging detector LHCb example

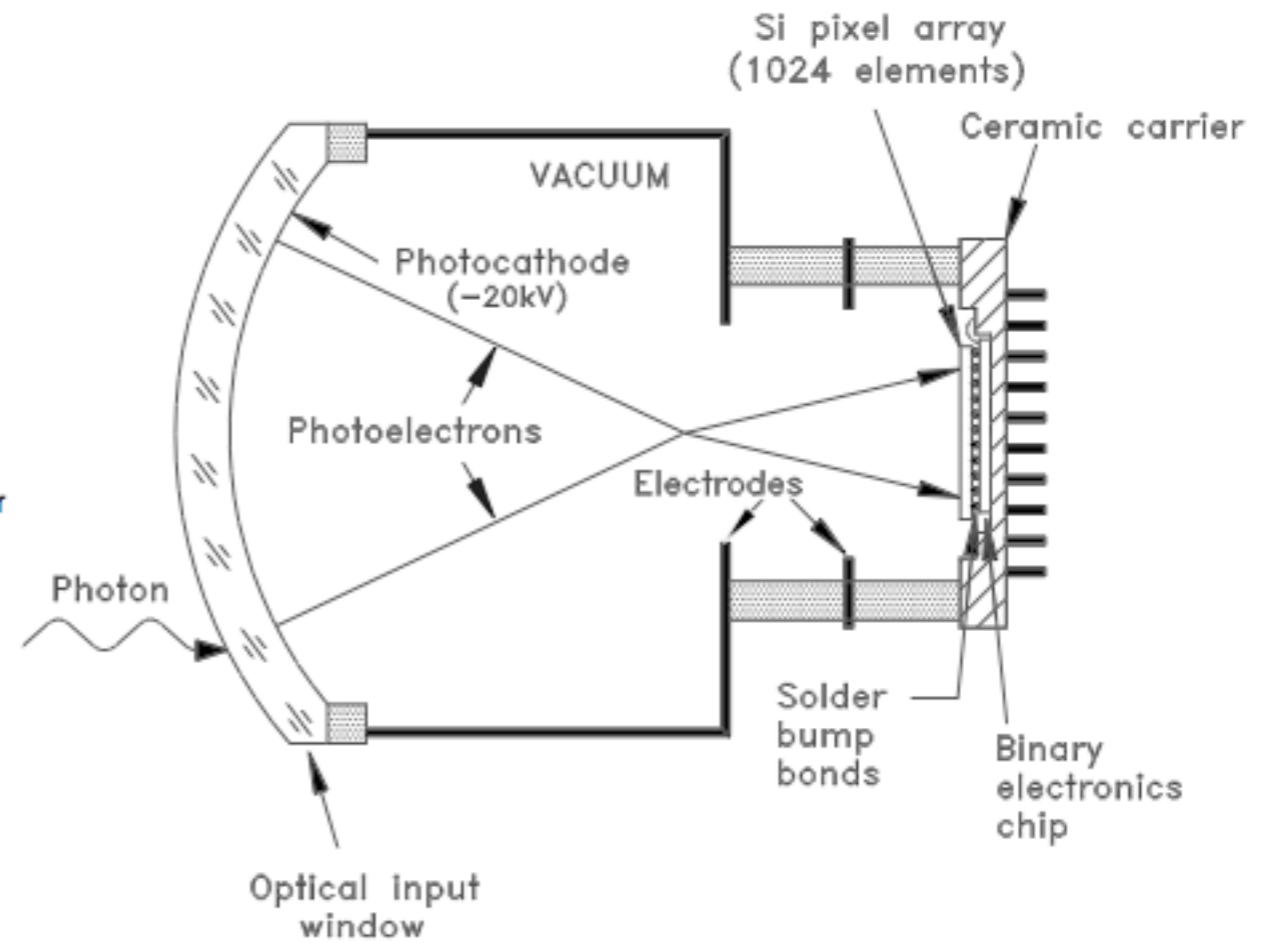
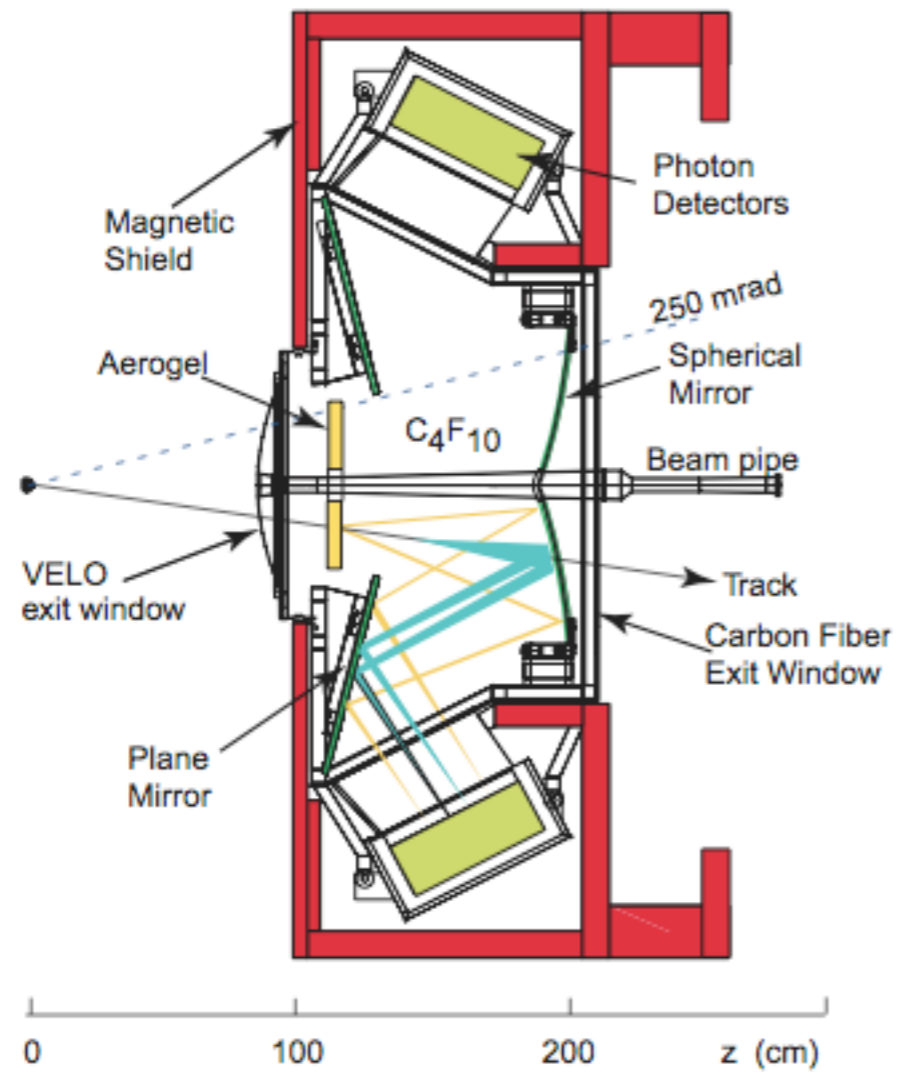

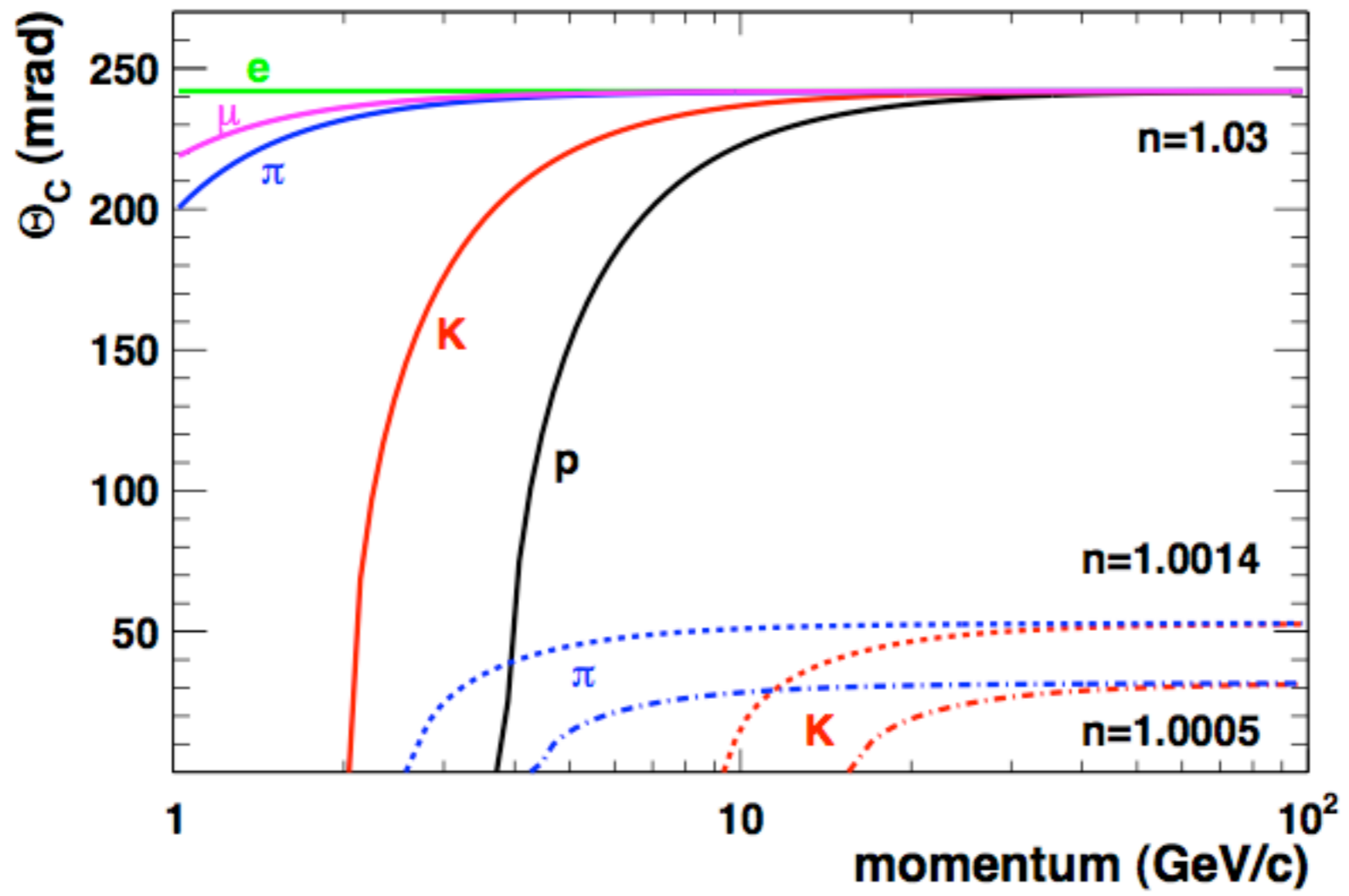

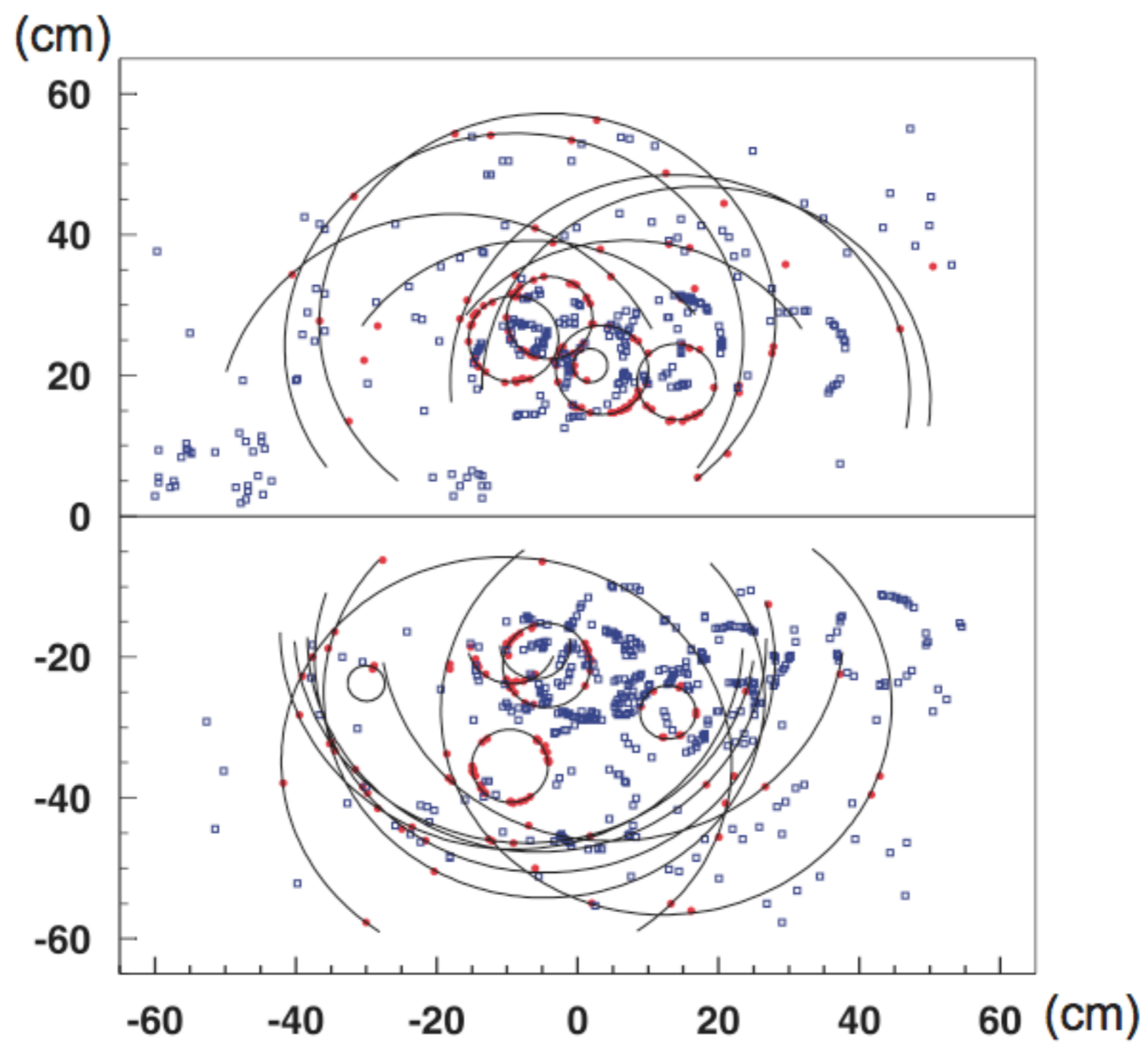
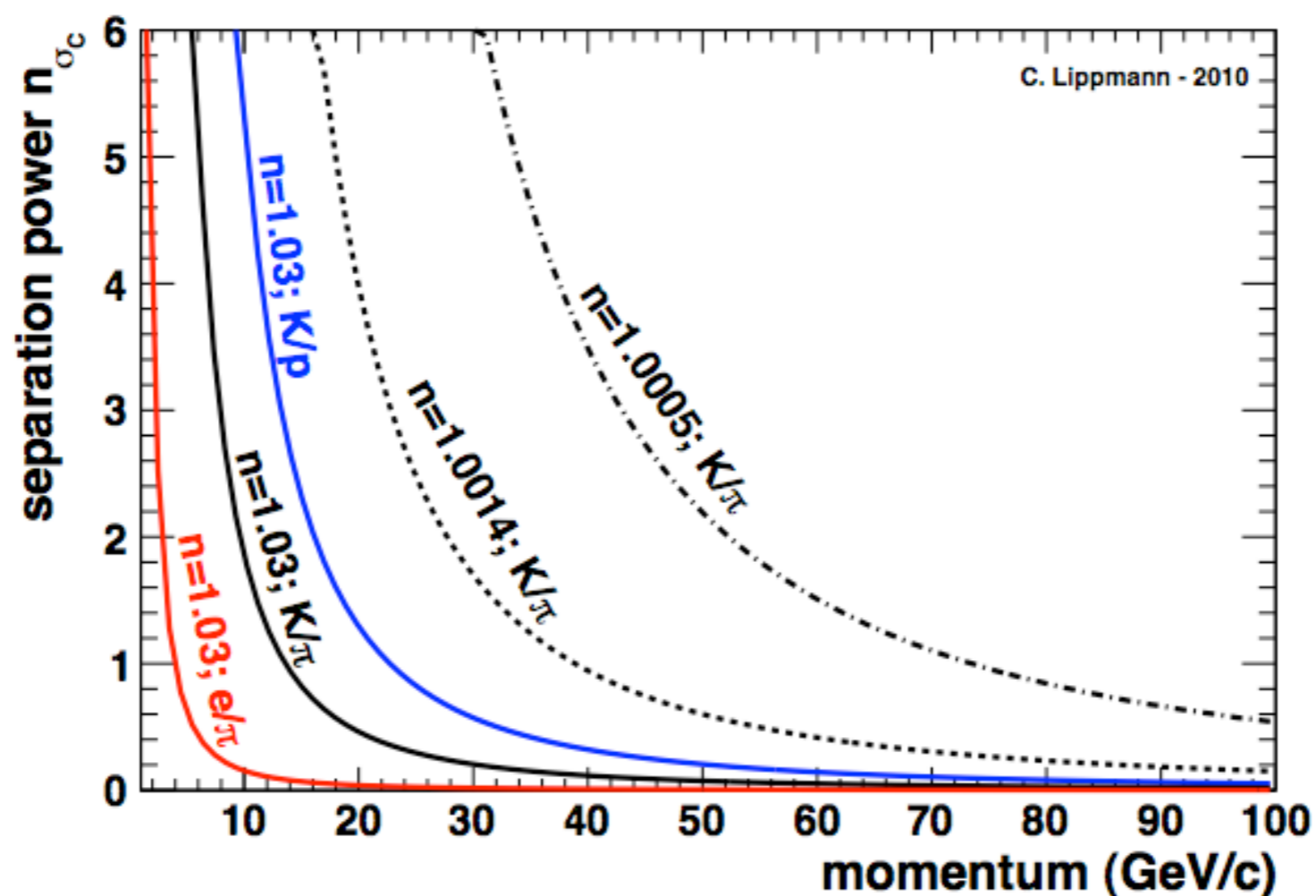

Table 3: Some parameters of the LHCb RICH detectors. The measured single photoelectron angular resolutions [87] are for the preliminary alignment available from the first data sample with p-p collisions at $\sqrt{s} = 7$ TeV.

| | | RICH1 | | RICH2 |
|--|------------|-----------------------|--------------------------------|------------------------------|
| | | Silica aerogel | C ₄ F ₁₀ | CF ₄ |
| Momentum range [GeV/c] | | ≤ 10 | $10 \lesssim p \lesssim 60$ | $16 \lesssim p \lesssim 100$ |
| Angular acceptance [mrad] | vertical | ± 25 to ± 250 | | ± 15 to ± 100 |
| | horizontal | ± 25 to ± 300 | | ± 15 to ± 120 |
| Radiator length [cm] | | 5 | 95 | 180 |
| Refractive index n | | 1.03 (1.037) | 1.0014 | 1.0005 |
| Maximum Cherenkov angle [mrad] | | 242 (268) | 53 | 32 |
| Expected photon yield at $\beta \approx 1$ | | 6.7 | 30.3 | 21.9 |
| σ_{Θ_i} [mrad] | expected | 2.6 | 1.57 | 0.67 |
| | measured | ~ 7.5 | 2.18 | 0.91 |



Need good software to reconstruct the Cherenkov cones for each charged particle

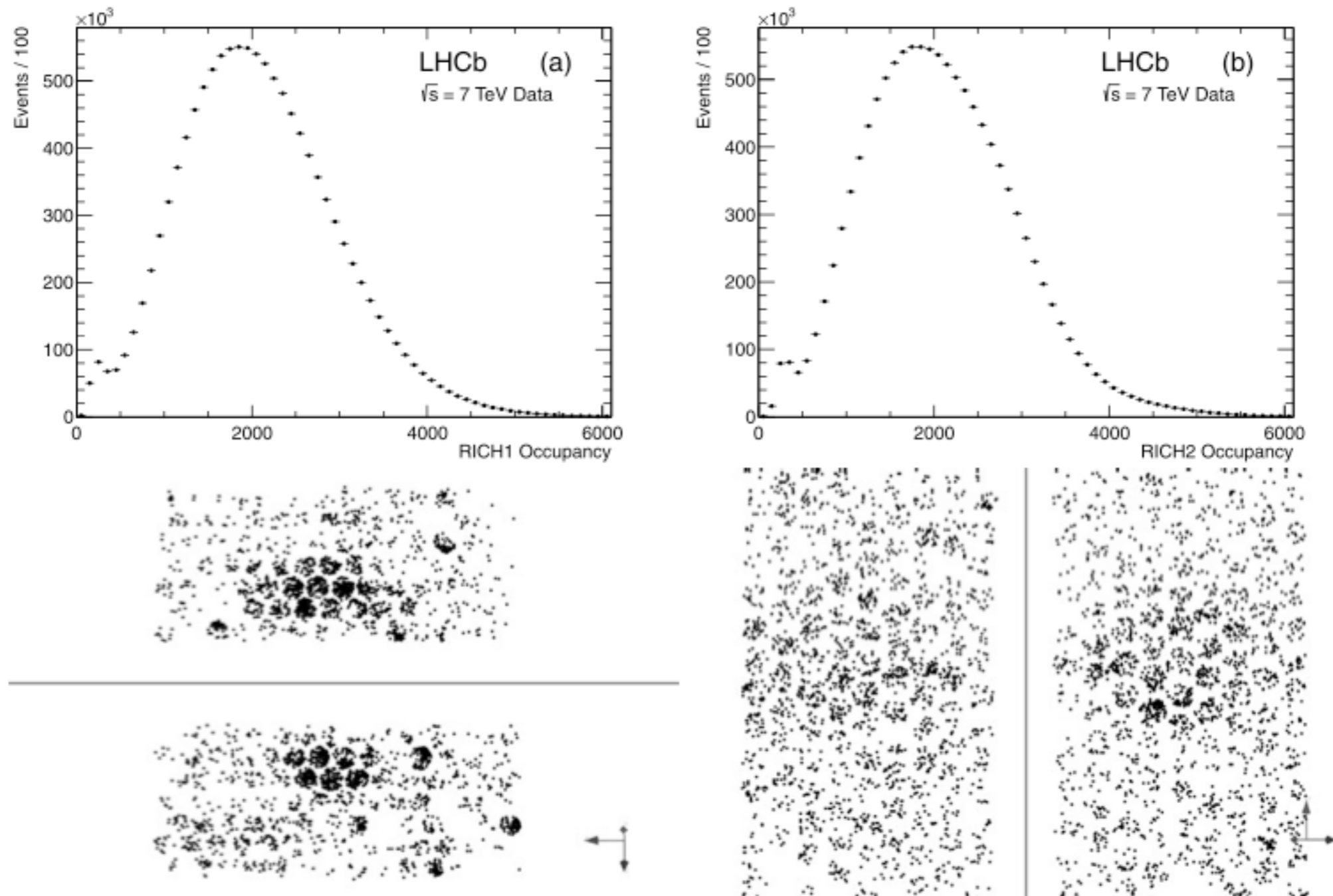
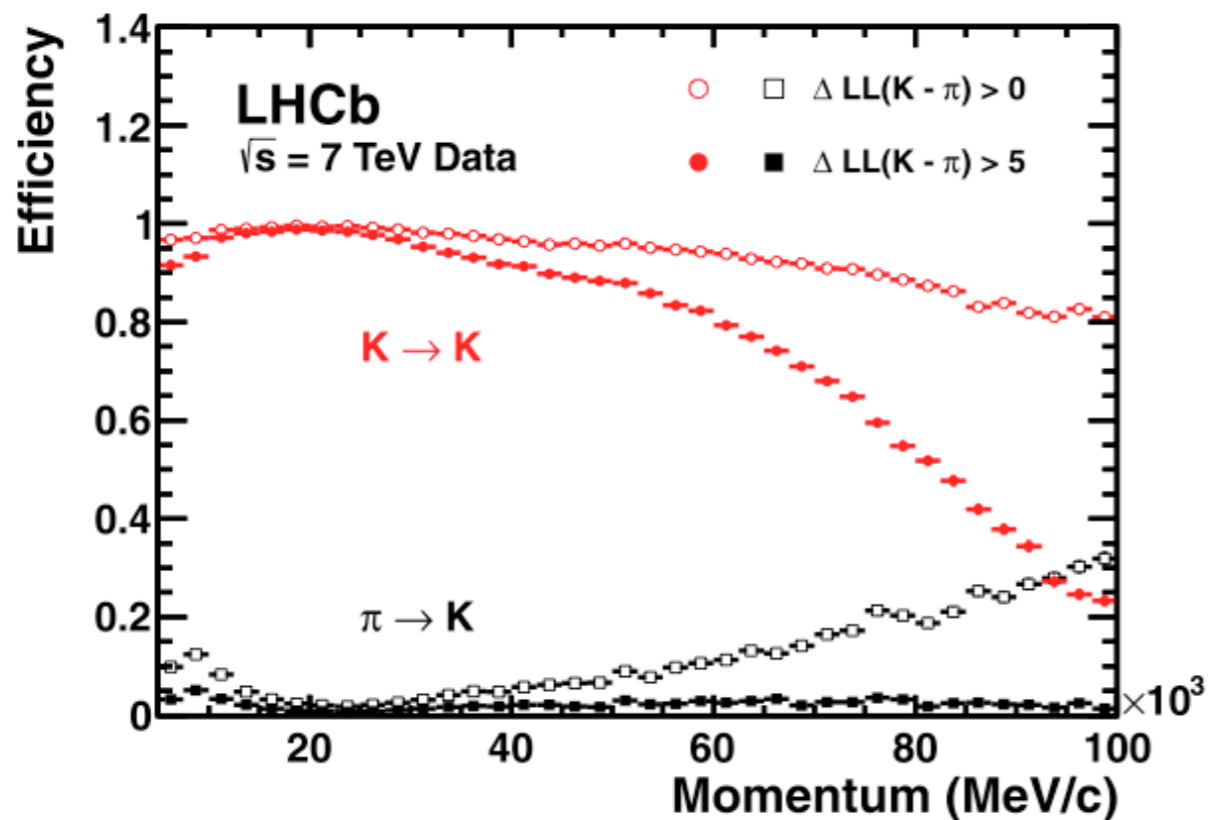

Fig. 13 Distribution of the number of pixel hits per event in (a) RICH 1 and (b) RICH 2. An example of a typical LHCb event as seen by the RICH detectors, is shown below the distributions. The *upper/lower* HPD panels in RICH 1 and the *left/right* panels in RICH 2 are shown separately



pi/kaon separation using RICH in LHCb

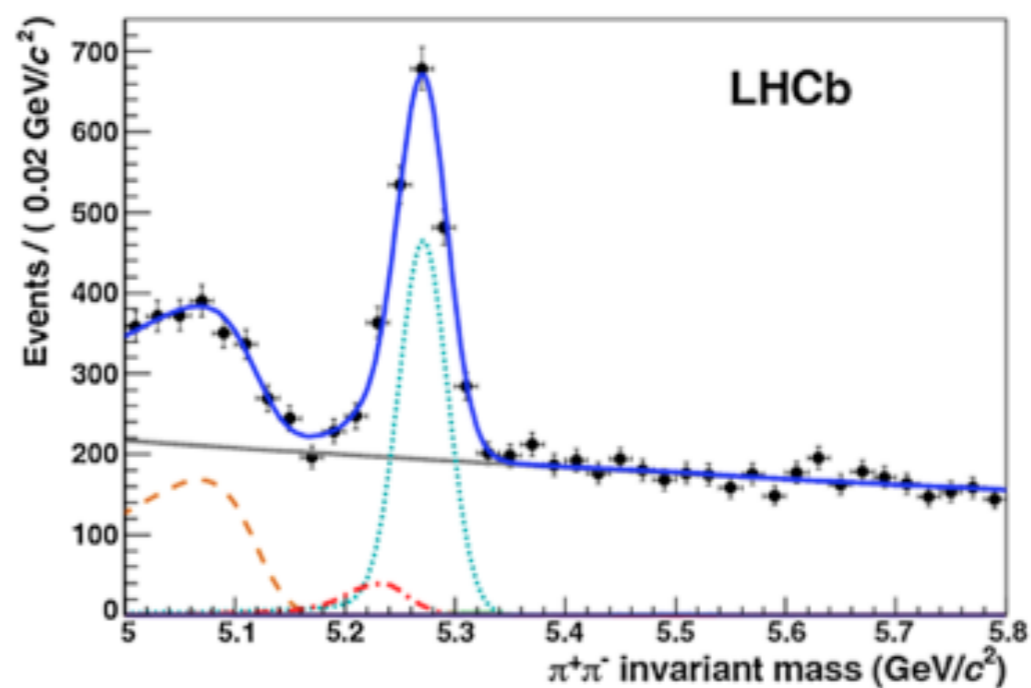
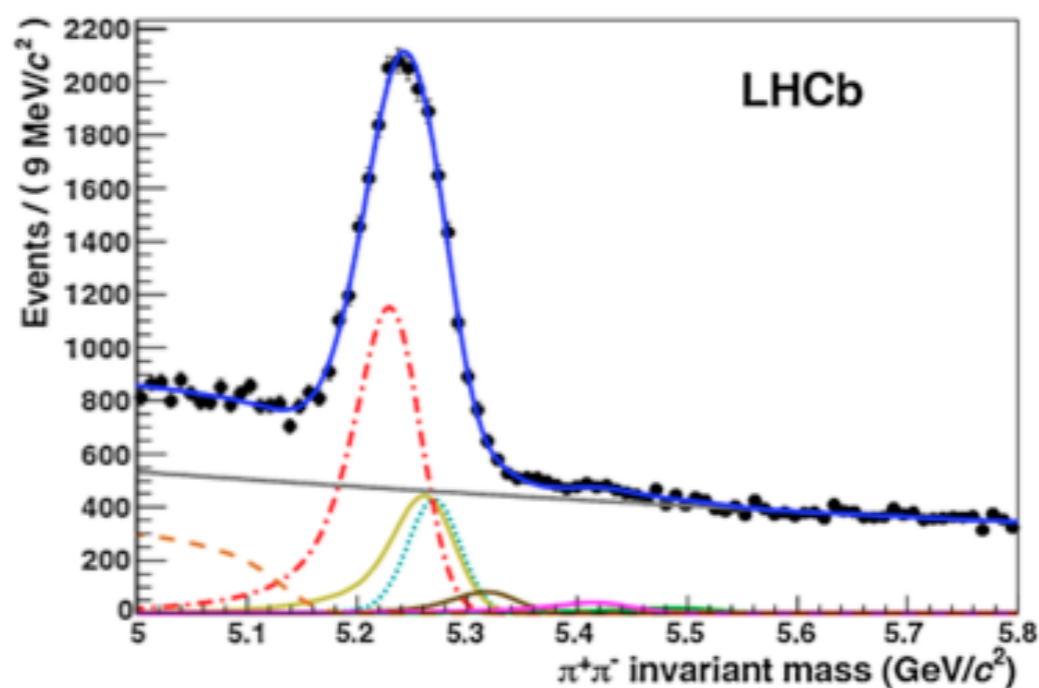
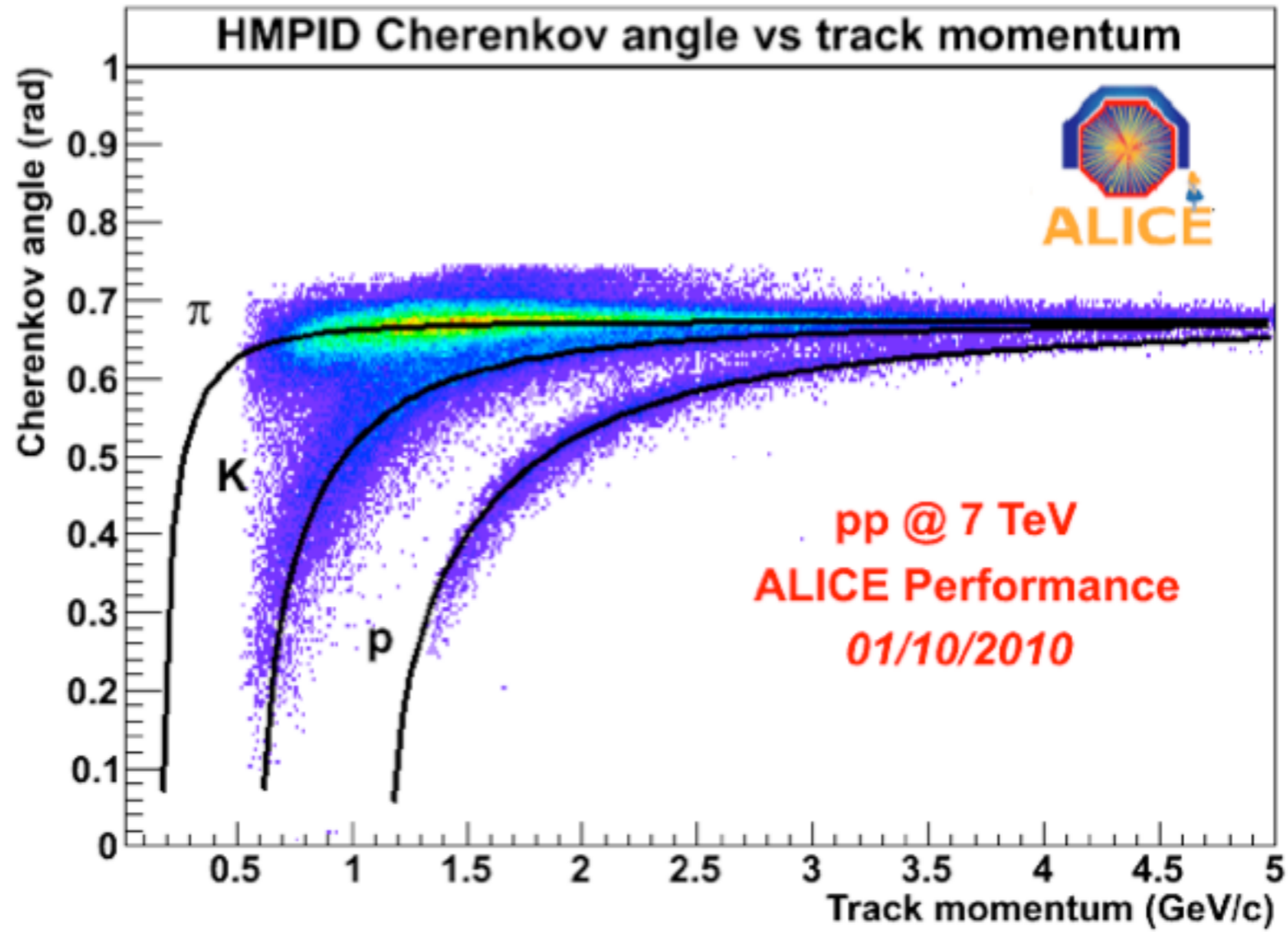

Fig. 2 Invariant mass distribution for $B \rightarrow h^+h^-$ decays [6] in the LHCb data before the use of the RICH information (*left*), and after applying RICH particle identification (*right*). The signal under study is the decay $B^0 \rightarrow \pi^+\pi^-$, represented by the turquoise *dotted line*. The contributions from different b -hadron decay modes ($B^0 \rightarrow K\pi$ *red dashed-dotted line*, $B^0 \rightarrow 3$ -body *orange dashed-dashed line*,

$B_s \rightarrow KK$ *yellow line*, $B_s \rightarrow K\pi$ *brown line*, $\Lambda_b \rightarrow pK$ *purple line*, $\Lambda_b \rightarrow p\pi$ *green line*), are eliminated by positive identification of pions, kaons and protons and only the signal and two background contributions remain visible in the plot on the right. The *grey solid line* is the combinatorial background (Color figure online)

Cherenkov detector in ALICE



Application of Cherenkov for neutrino detector

neutrino interaction in water produces muon or electron
which are above Cherenkov threshold
Light is detected by photo multipliers around the water tank

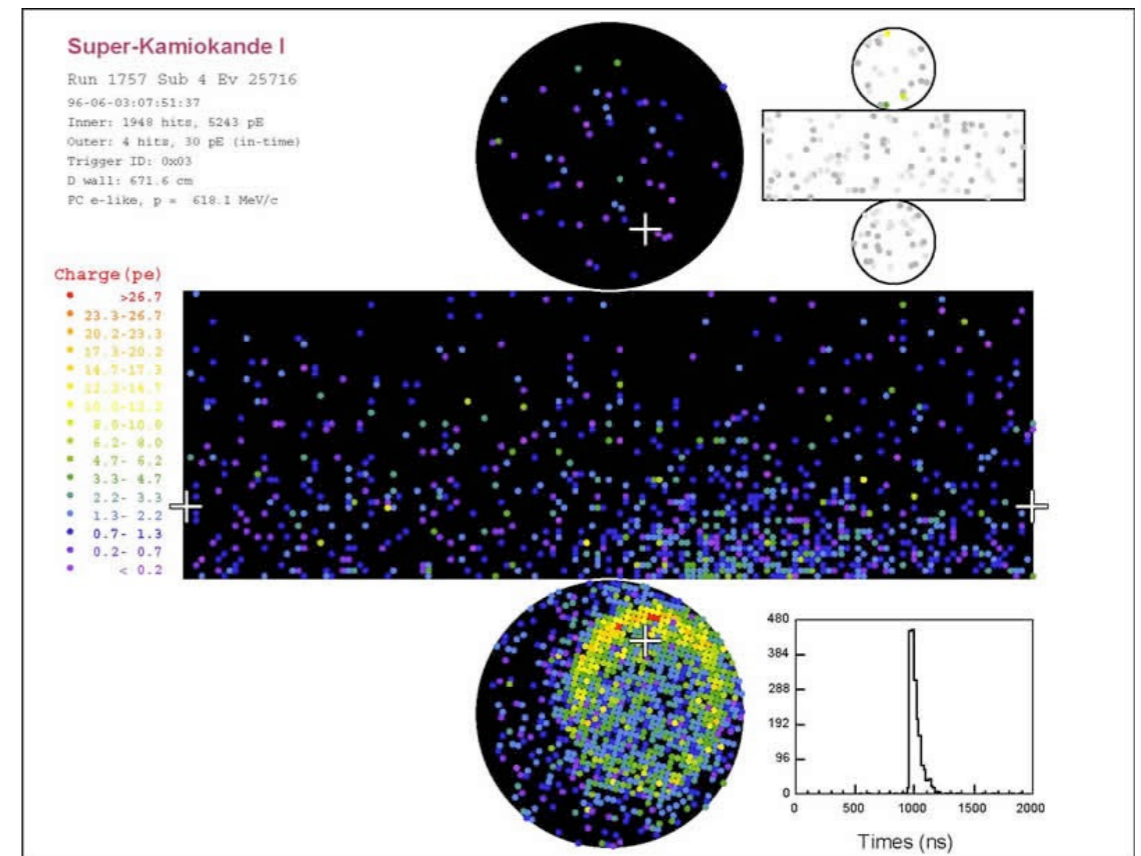
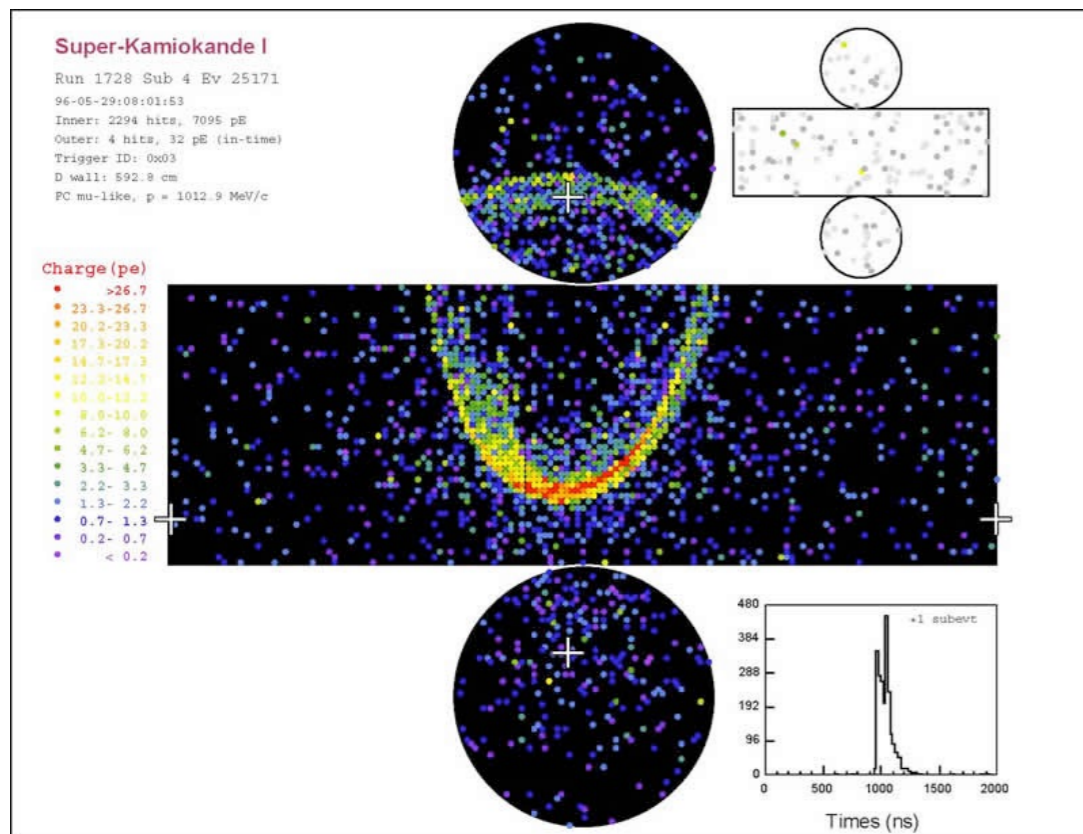

Comparison of different techniques

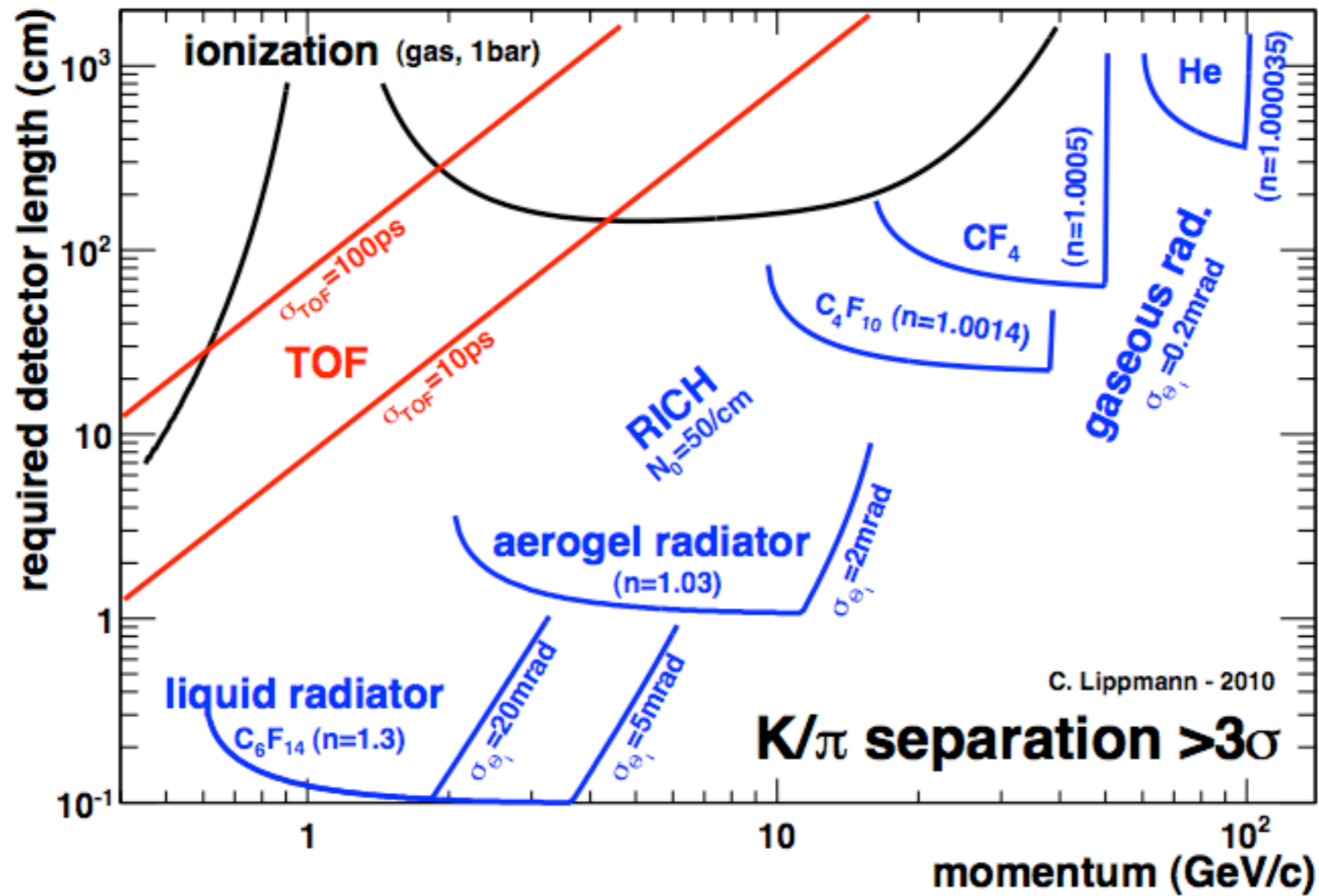

Transition radiation

When charge ze crosses boundary vacuum/medium

$$I = \frac{1}{3} \alpha z^2 \gamma \hbar \omega p$$

$$\hbar \omega p = \sqrt{4\pi N_0 e^3 \frac{m_e c^2}{\alpha}} = \sqrt{S / (\text{g/cm}^3) \langle \frac{Z}{A} \rangle} \times 28.81 \text{ eV}$$

Typical values $\hbar \omega p \sim 20 \text{ eV}$ (0.7 for air)

Half energy between 0.1 and 1, $\gamma \hbar \omega p$

Typically $\sim 0.005 \gamma$ with $\hbar \omega > 0.1 \gamma \hbar \omega p$

Formation length \sim tens of μm

Needs many interfaces to increase photon yield

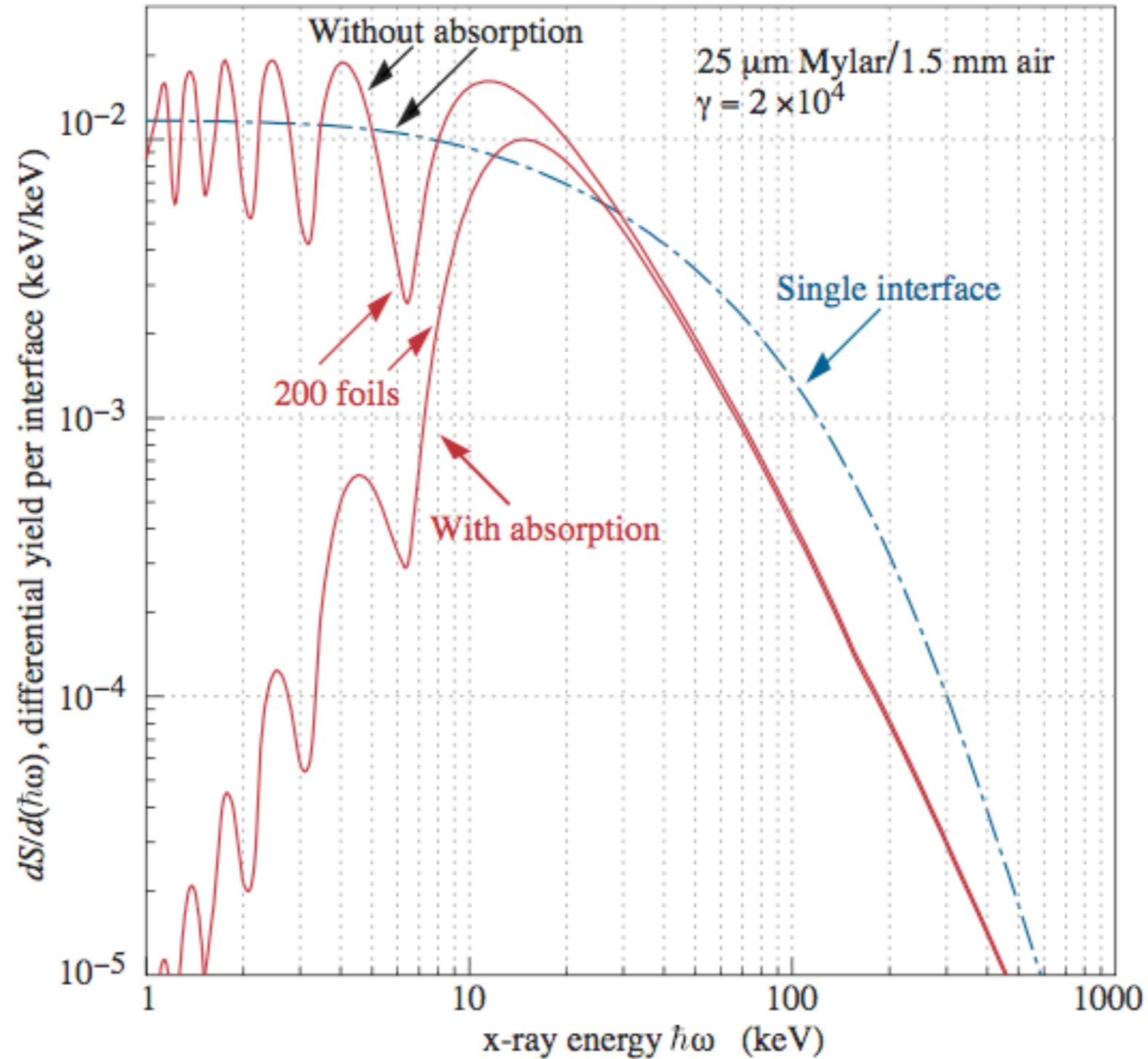

X-rays detected for instance by photo-electric effect in high
Z material like Xenon gas
=> Detector consists of radiator + photon detector

Photon interaction in matter

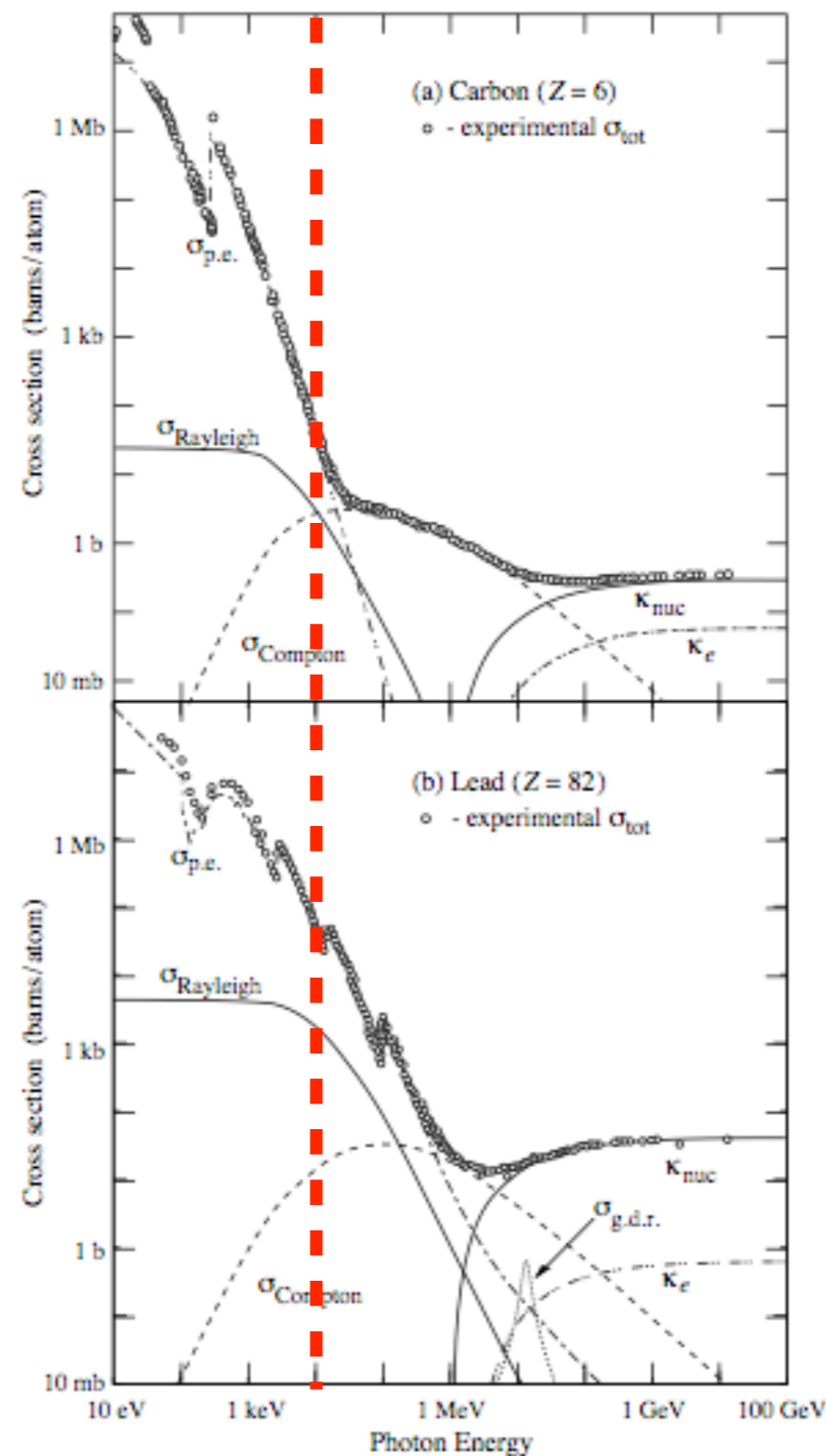
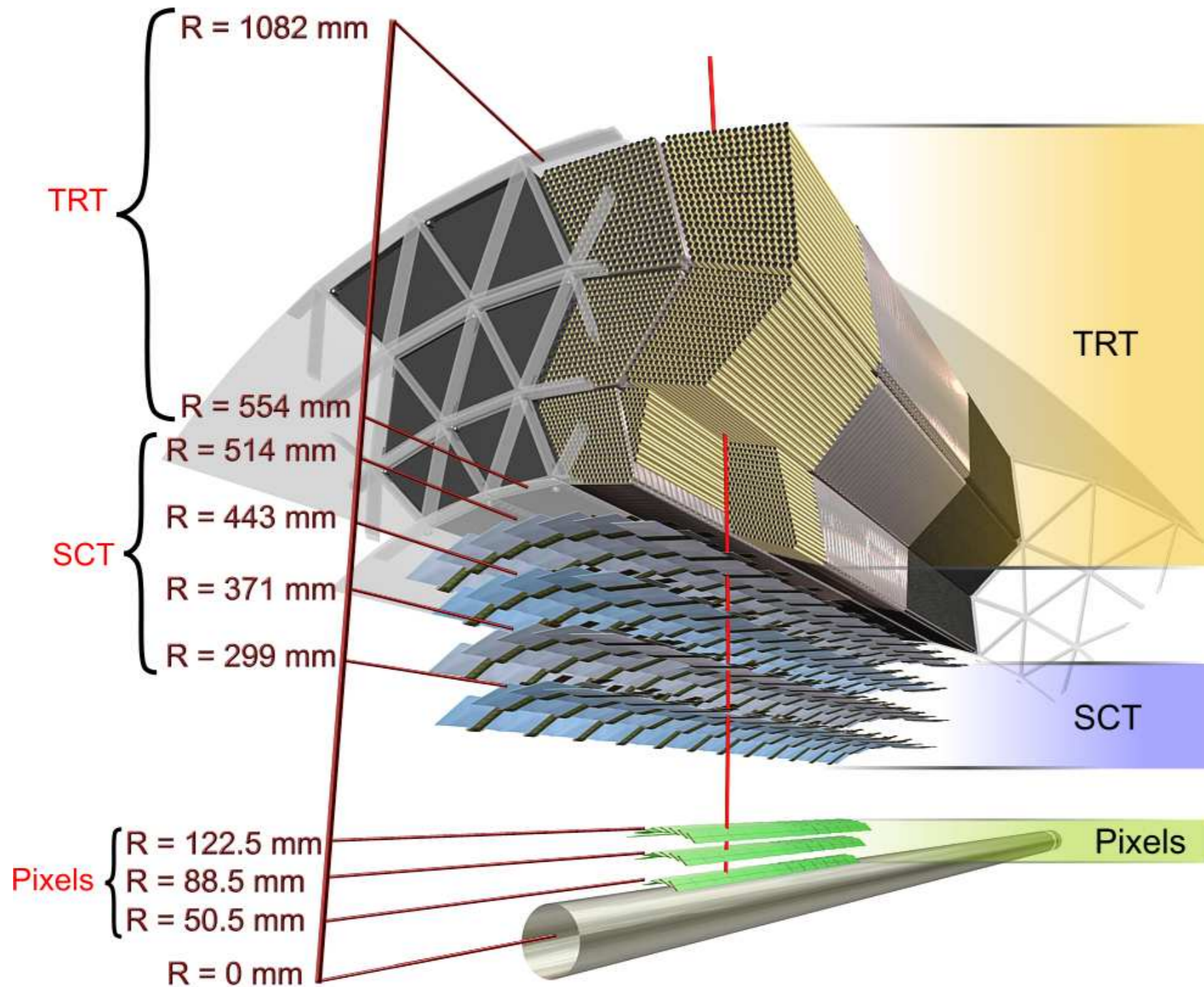
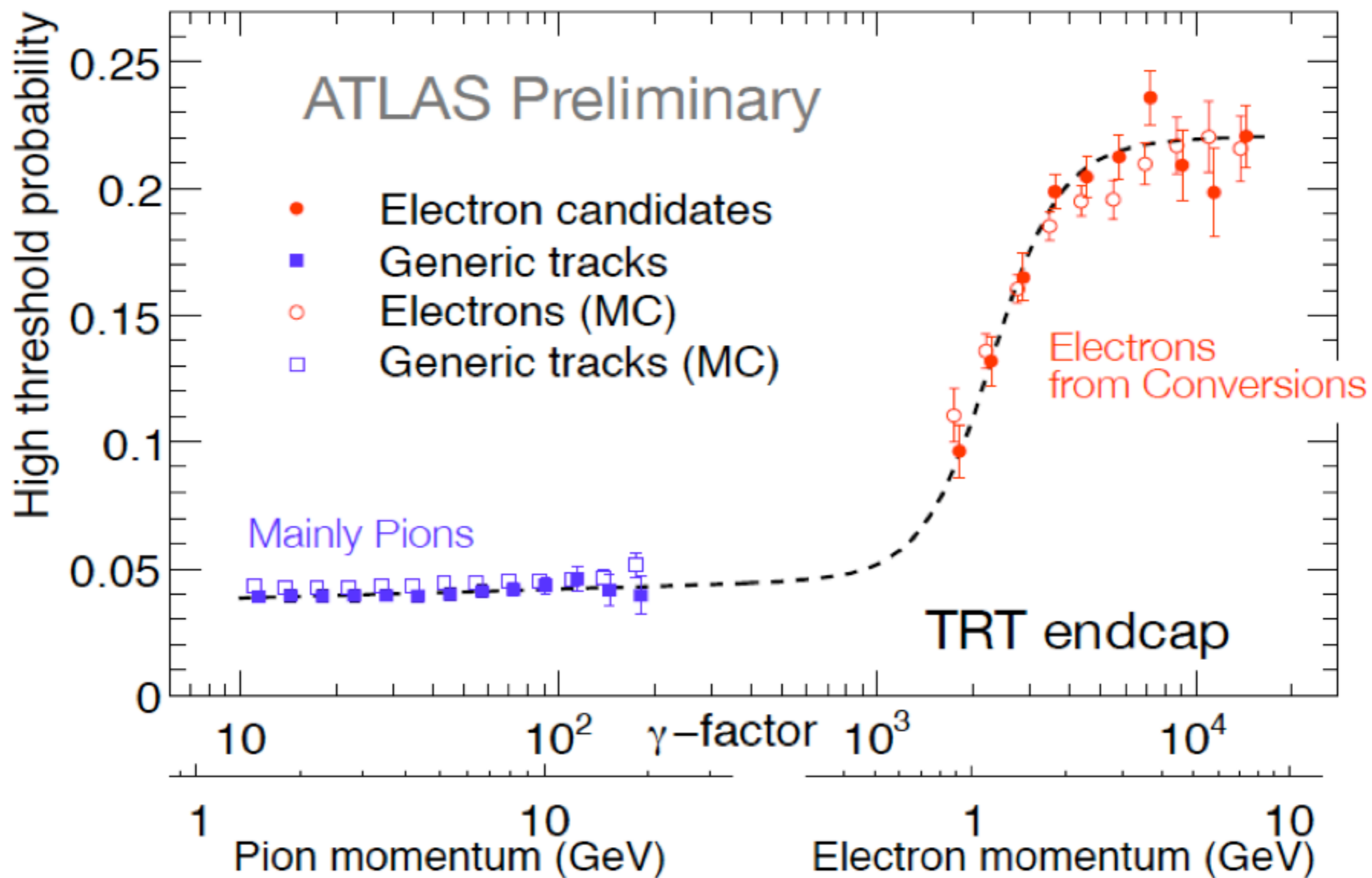

Figure 31.15: Photon total cross sections as a function of energy in carbon and lead, showing the contributions of different processes [51]:

- $\sigma_{p.e.}$ = Atomic photoelectric effect (electron ejection, photon absorption)
- σ_{Rayleigh} = Rayleigh (coherent) scattering—atom neither ionized nor excited
- σ_{Compton} = Incoherent scattering (Compton scattering off an electron)
- κ_{nuc} = Pair production, nuclear field
- κ_e = Pair production, electron field
- $\sigma_{g.d.r.}$ = Photonuclear interactions, most notably the Giant Dipole Resonance [52].
In these interactions, the target nucleus is broken up.

Radiator = polypropylene foils
Detector = Straws with wire in the middle containing Xe
(to absorb X-rays)
Edeposited ~ 2 keV from ionization, $\sim 8-10$ KeV from TR photons





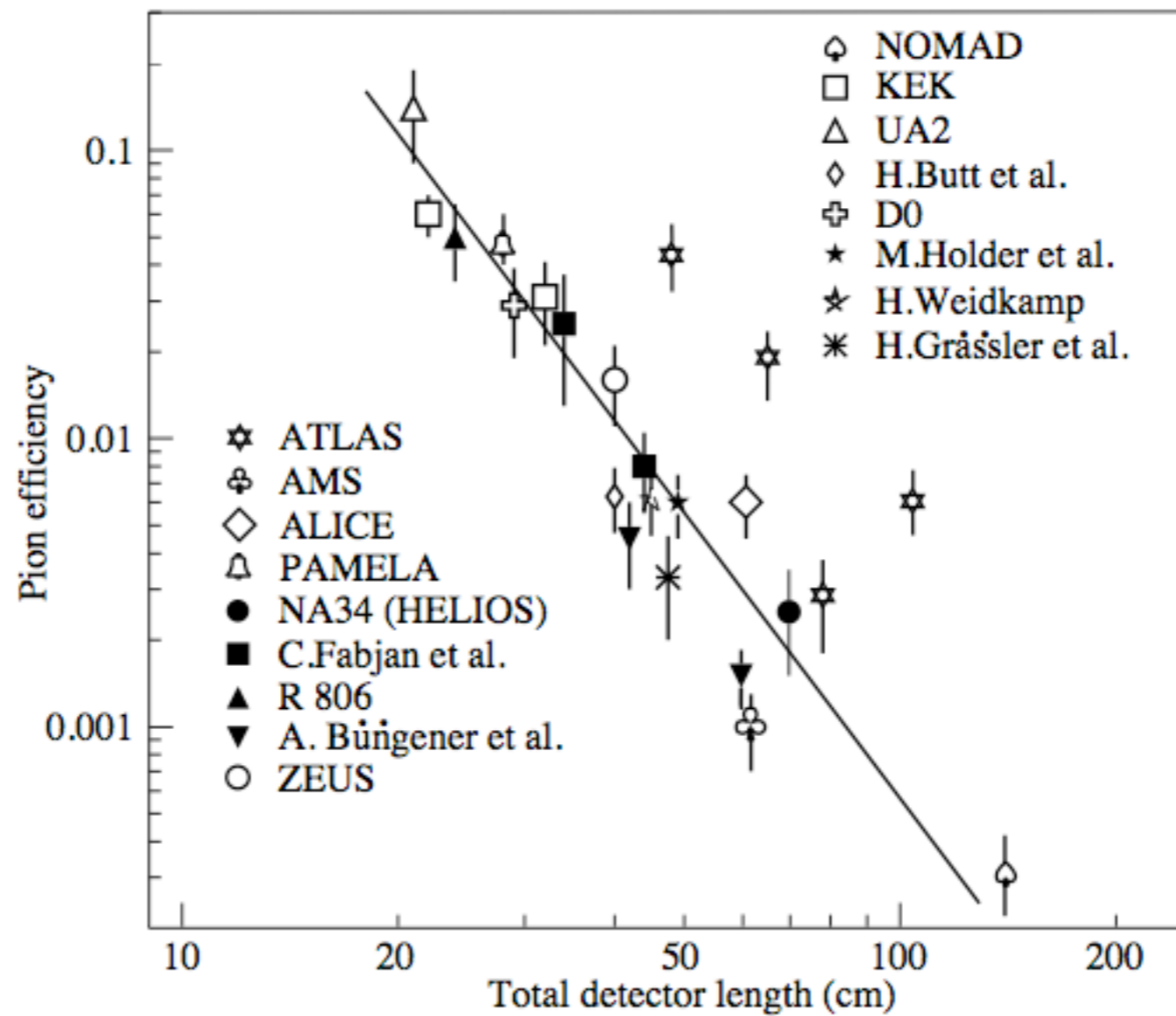

Reconstruction of particle decay

- Useful for short lived particles
 - very short lived => use invariant mass of daughter particles
 - Examples are $K_s \rightarrow \pi^+ \pi^-$, $J/\psi \rightarrow \mu^+ \mu^-$, W, Z decays, etc..
 - not so short lived => can measure distance between production and decay positions:
 - tau lepton
 - B-hadron

Exploiting kinematic information from Dalitz plots

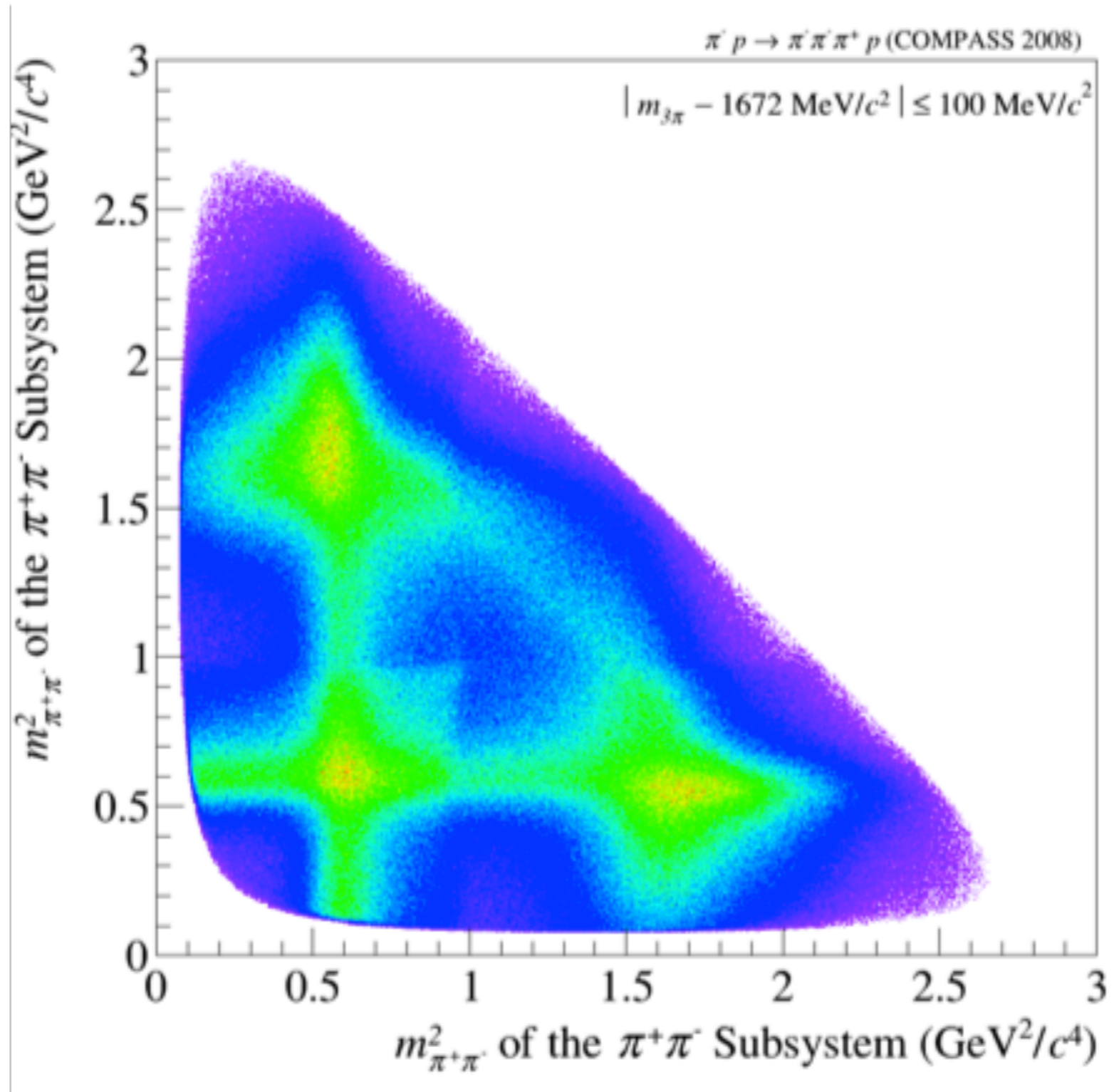

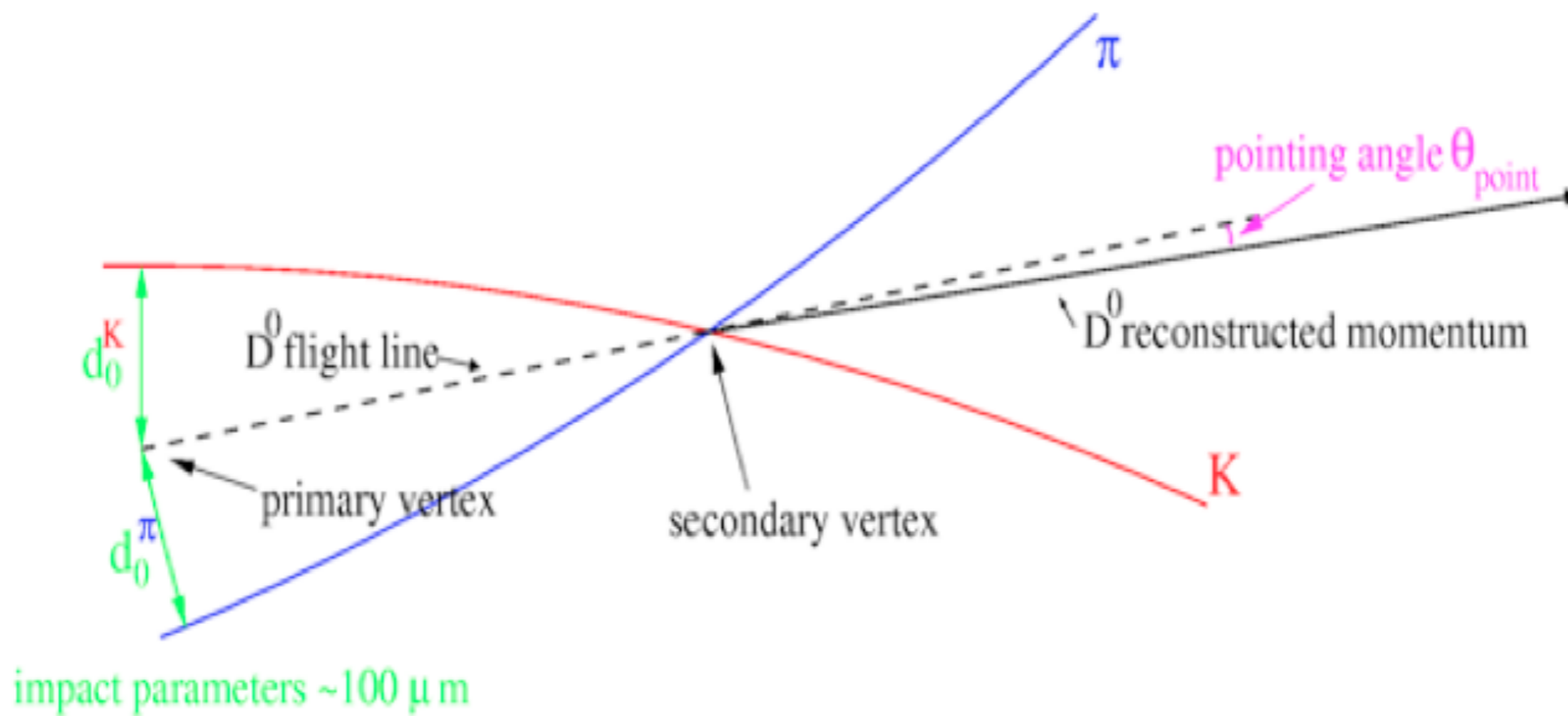

lifetimes: $D^0: 4.10^{-13}\text{s}$, $B^0_d 1.5 10^{-12}\text{s}$, $\tau: 2.9 10^{-13}\text{s}$

Decay length $\beta \cdot \gamma \cdot c \cdot \tau \Rightarrow \beta \cdot \gamma \cdot 450 \text{ microns}$ for B^0_d

Impact parameter $\sim (c \cdot \tau)$

Vertex projection from two points: a simplified approach (telescope equation)

$$\text{pointing resolution} = (a \oplus b) \mu\text{m}$$

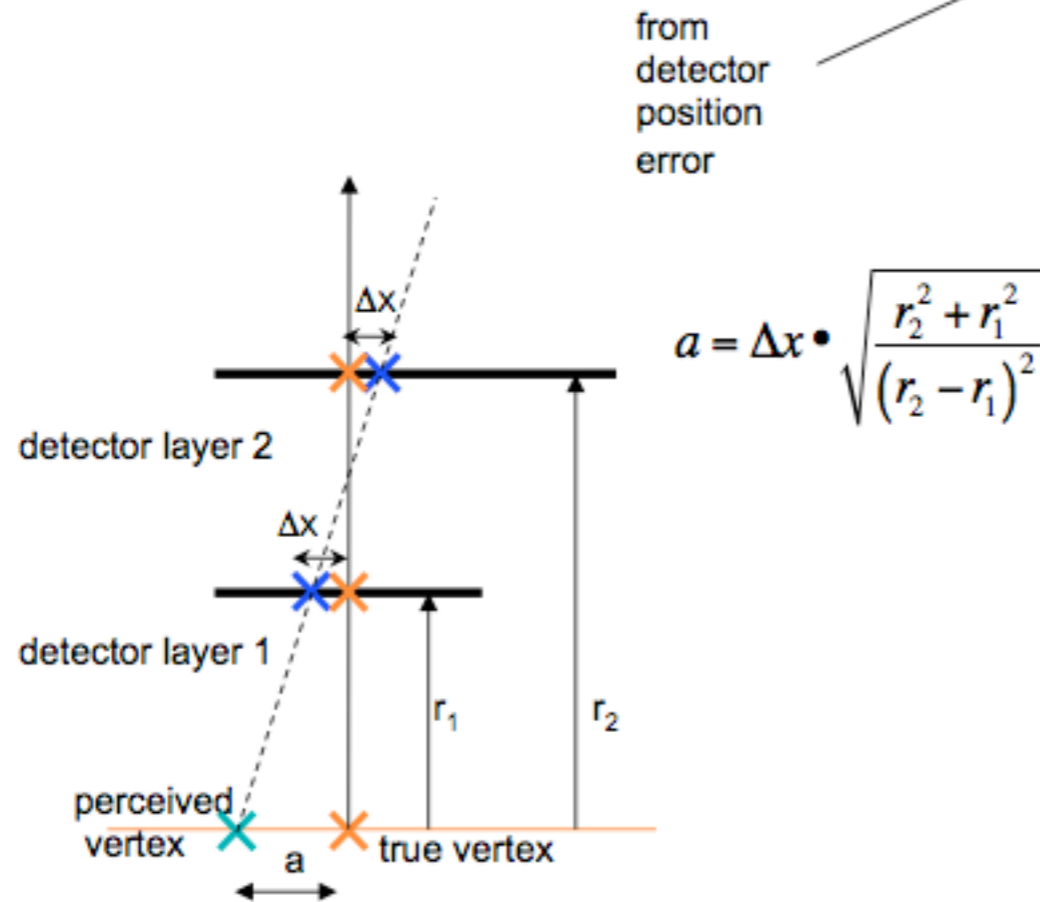

Detector Granularity, minimize Δx :

e.g. 50 μm pixel and r_2 very large compared to r_1

$$\rightarrow a = \Delta x = 50 / \sqrt{12} = 15 \mu\text{m}$$

from coulomb scattering

$$\theta_m = \frac{13.6 \text{ MeV}}{\beta \cdot c \cdot p} \cdot \sqrt{x / X_0}$$

$$b = \theta_m \cdot r_1$$

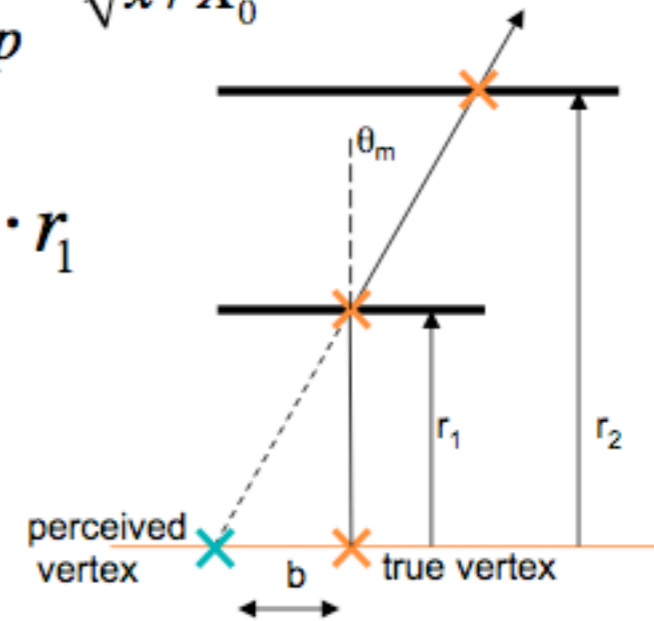

First layer as close as possible to the vertex and
First layer with minimal amount of material.

e.g. $x/X_0 = 0.0114$, $r_1 = 39 \text{ mm}$

$$\rightarrow b = 57 \mu\text{m} \text{ for } p = 1 \text{ GeV}/c$$

Example of ATLAS pixel silicon detector

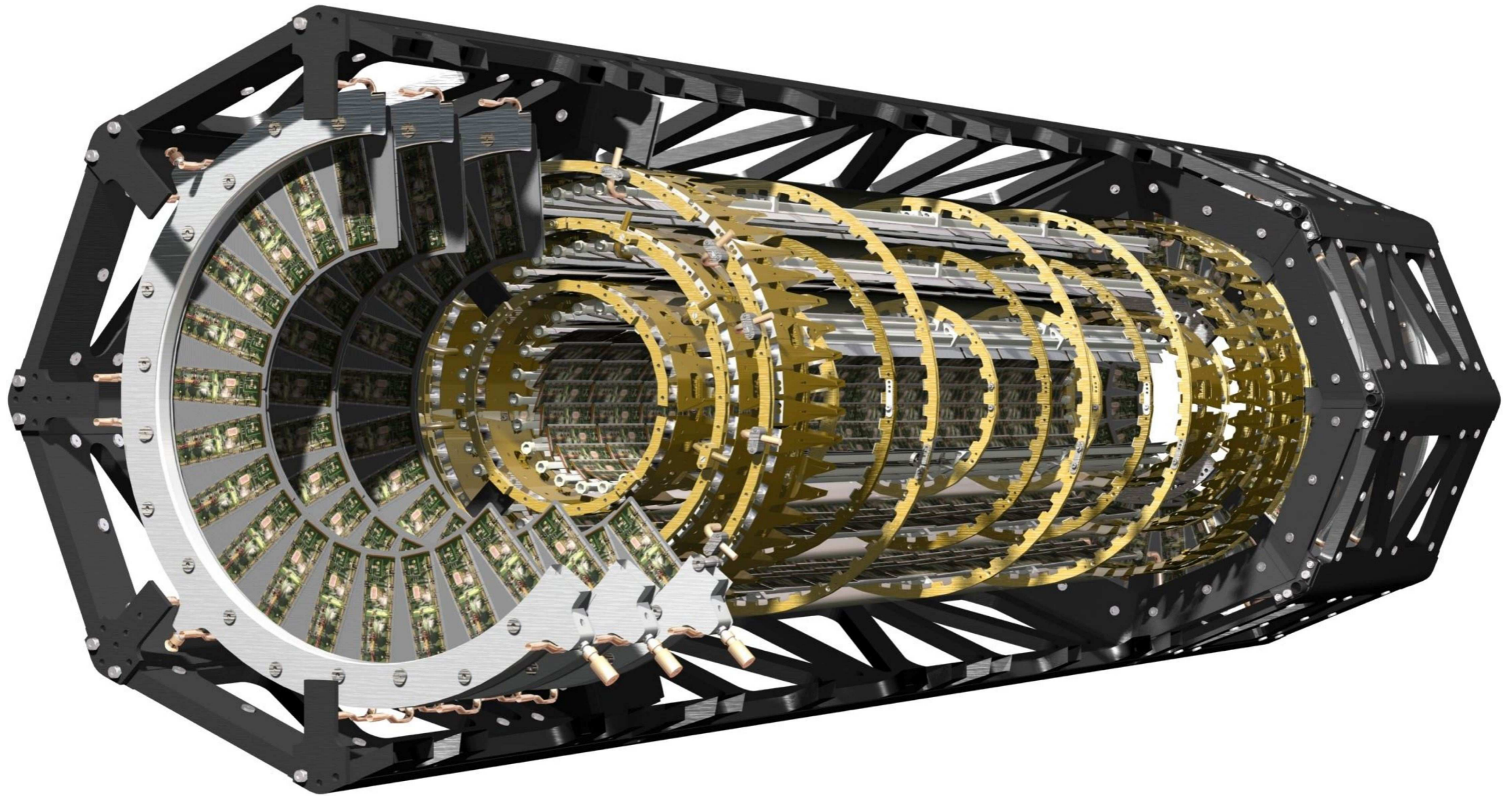

b-tagging performances

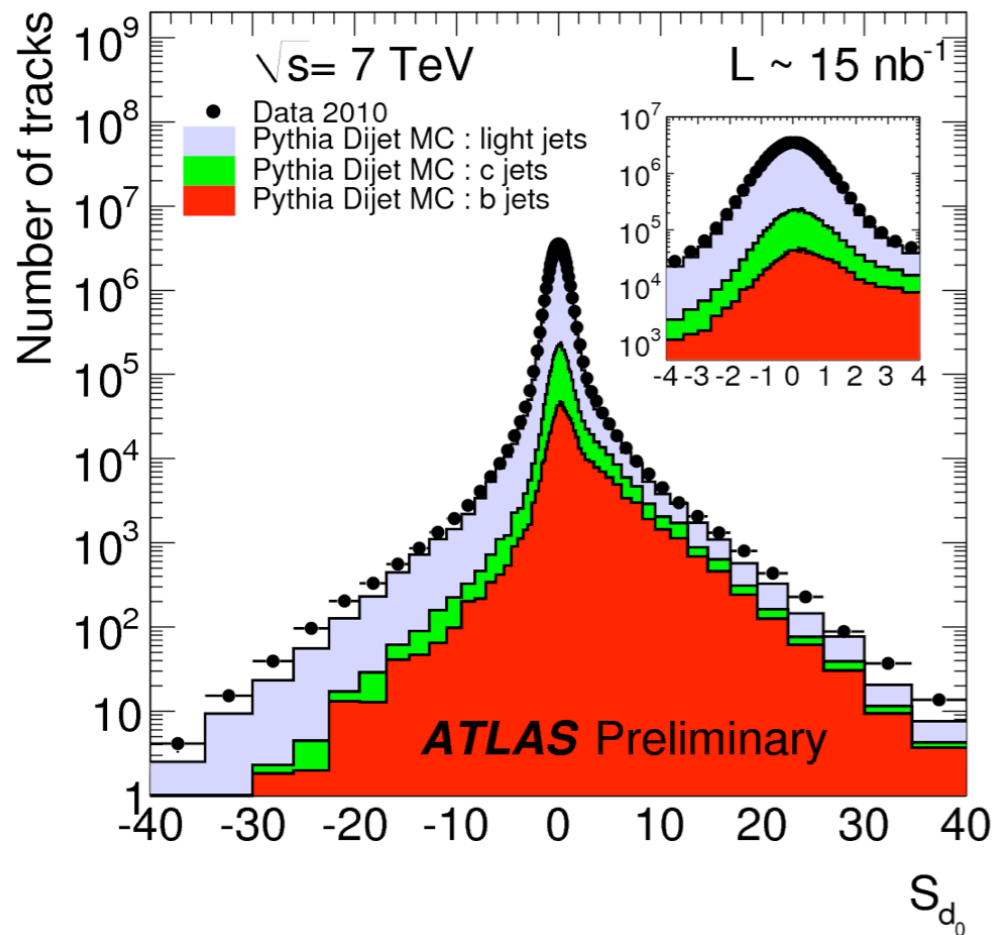

Track impact parameter/error

Algorithms combining impact parameter information + secondary vertex reconstruction

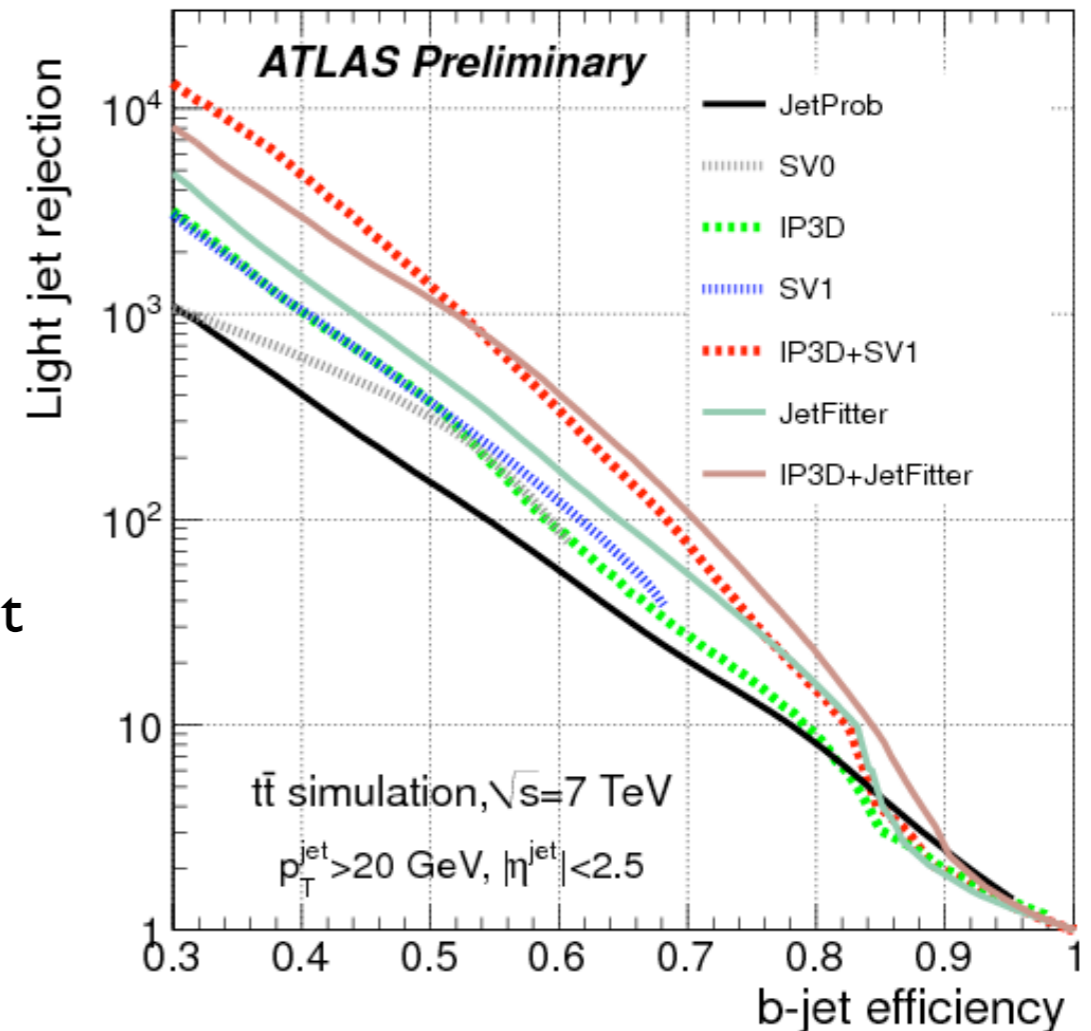

Example of b-tagging usage for top quark discovery

Signal $t \bar{t} \rightarrow W W b \bar{b}$,
one $W \rightarrow \text{lepton}$, one $W \rightarrow \text{jets}$

Background: $W(-\rightarrow \text{lepton}) + \text{jet}$
Only a small amount of these
jets have b quarks.

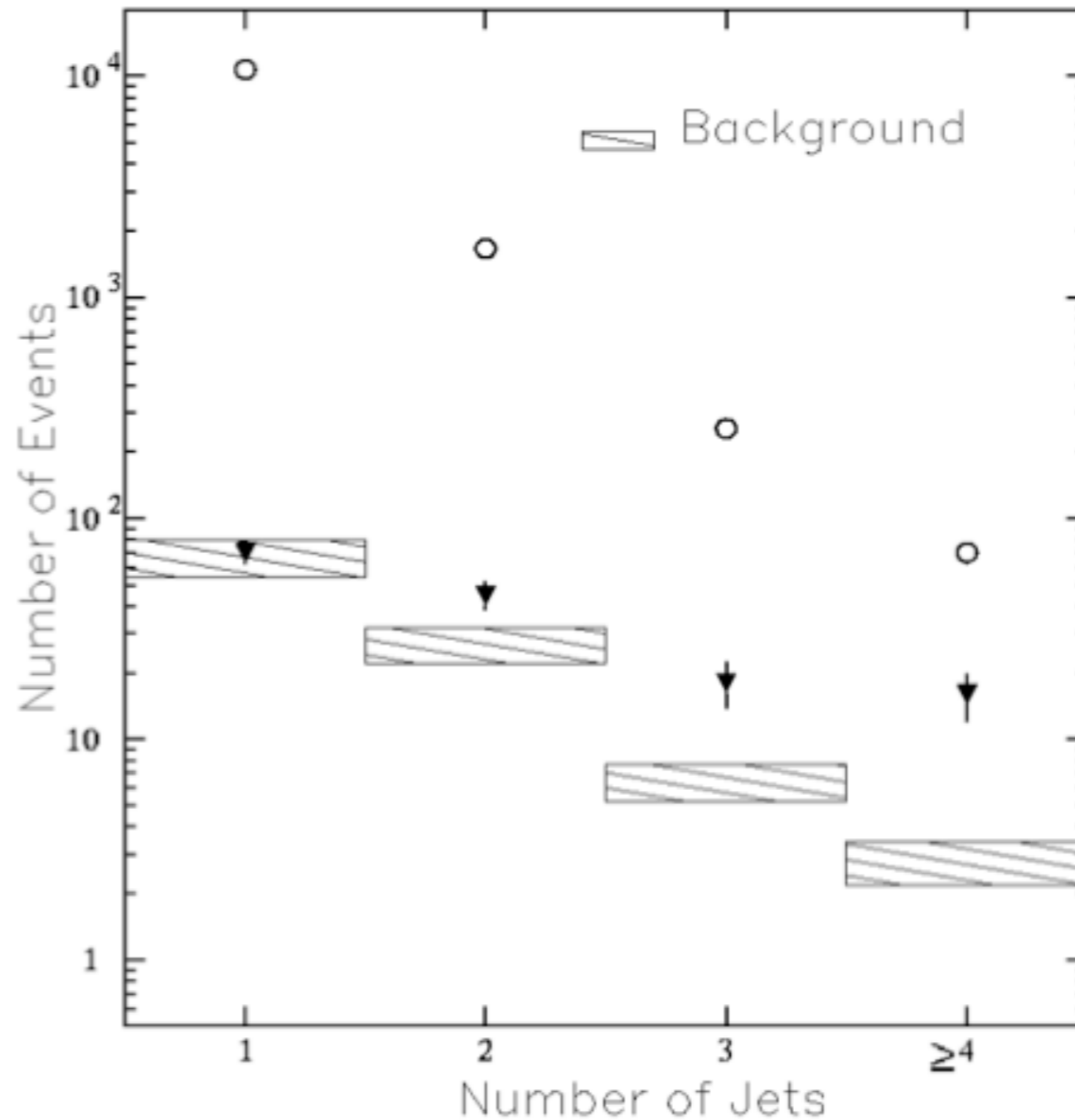

e + 4 jet event

40758_44414

24-September, 1992

TWO jets tagged by SVX

fit top mass is 170 ± 10 GeV

e^+ , Missing E_t , jet #4 from top

jets 1,2,3 from top (2&3 from W)

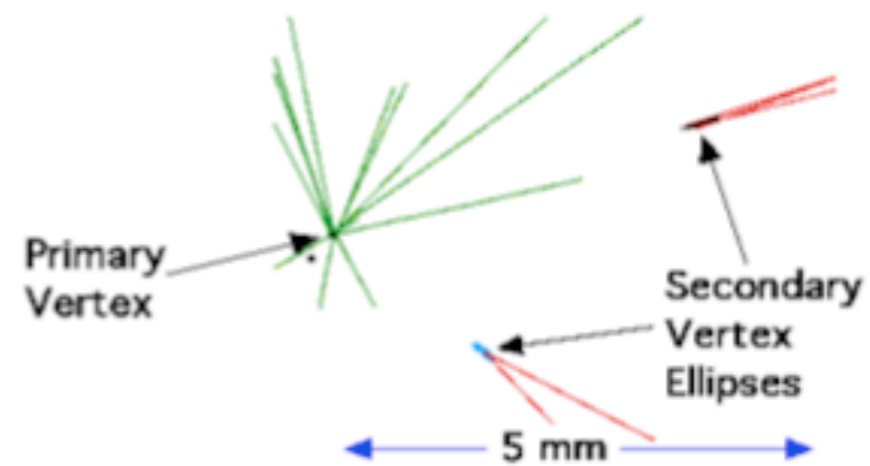
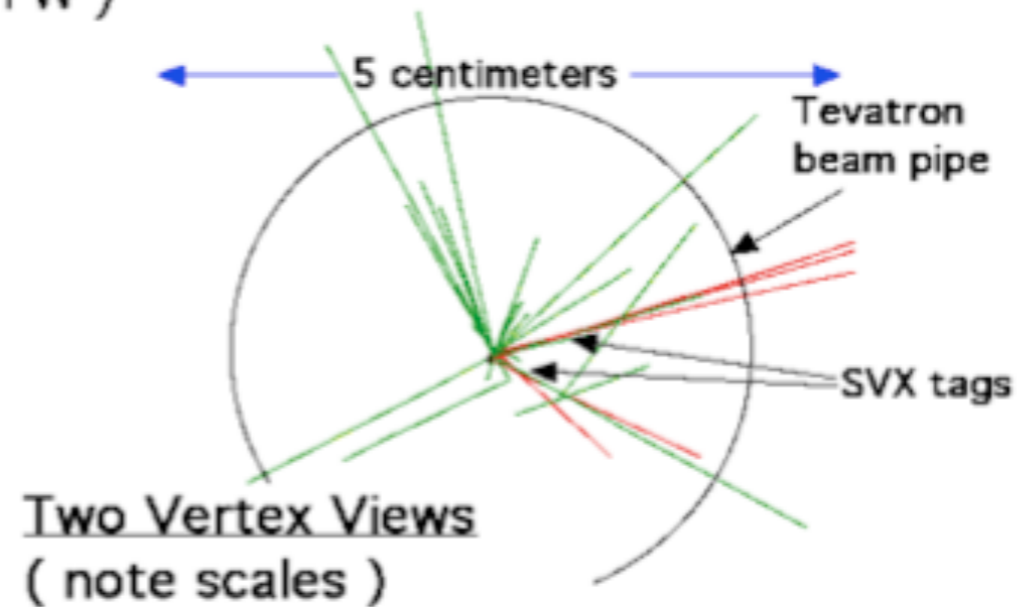
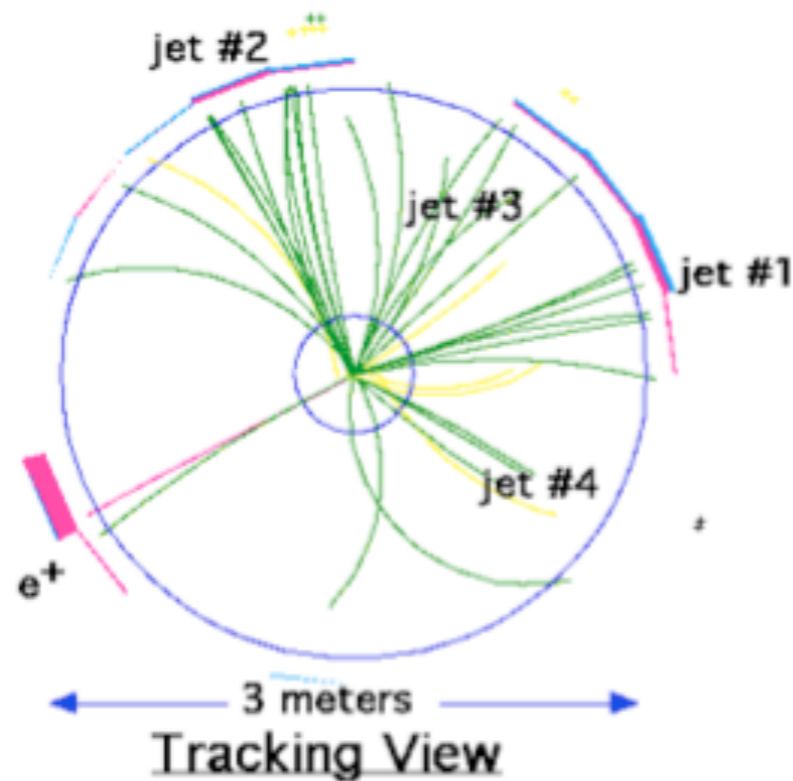
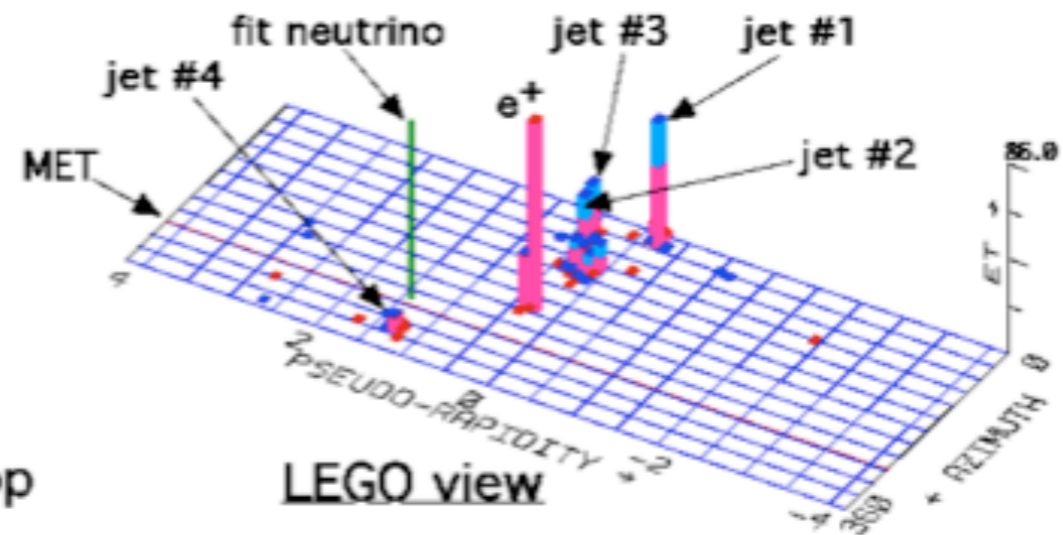

Example of application of particle ID and secondary vertex : Bs mixing measurement

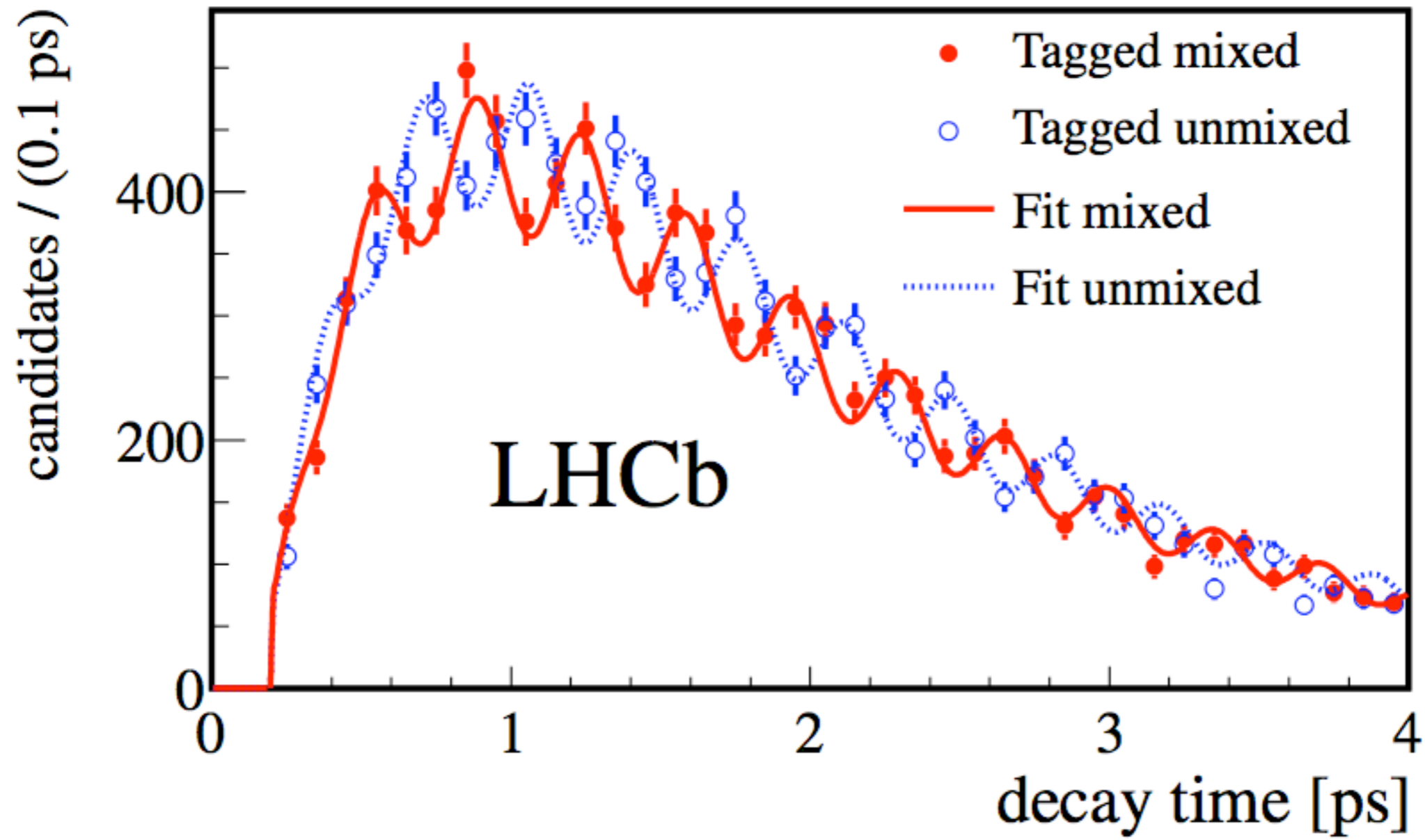

Particle Flow techniques in collider experiments

- Different particles species are measured more accurately with different techniques
 - What is the most precise technique for $E=100$ GeV electron energy measurement in a LHC experiment ?
 - What is the most precise technique to measure a few GeV charged pion ?
 - What is the most precise technique to measure a 5 GeV K0L ?
 - How can one separate particles from different interactions in the same bunch crossing at the LHC ?

Charged particle momentum measurement

$$\left\{ \begin{array}{l} \text{Detector resolution} \quad \sigma\left(\frac{L}{p_L}\right) = ct_e \Rightarrow \frac{\sigma_{p_L}}{p_L} = a \cdot p_L \quad a \propto \frac{1}{BL^2} \\ \text{Multiple scattering} \quad \sigma_\theta \propto \frac{13.6 \text{ MeV}}{p} \sqrt{\frac{x}{X_0}} \\ \sigma\left(\frac{1}{p_L}\right) \propto \sigma_\theta \Rightarrow \frac{\sigma_{p_L}}{p_L} = b \quad (b \propto \frac{1}{B}) \end{array} \right.$$

Calorimeter energy measurement

$$\frac{\sigma_E}{E} = \frac{a}{\sqrt{E}} \oplus \frac{b}{E} \oplus c$$

Also have to deal with pileup interactions

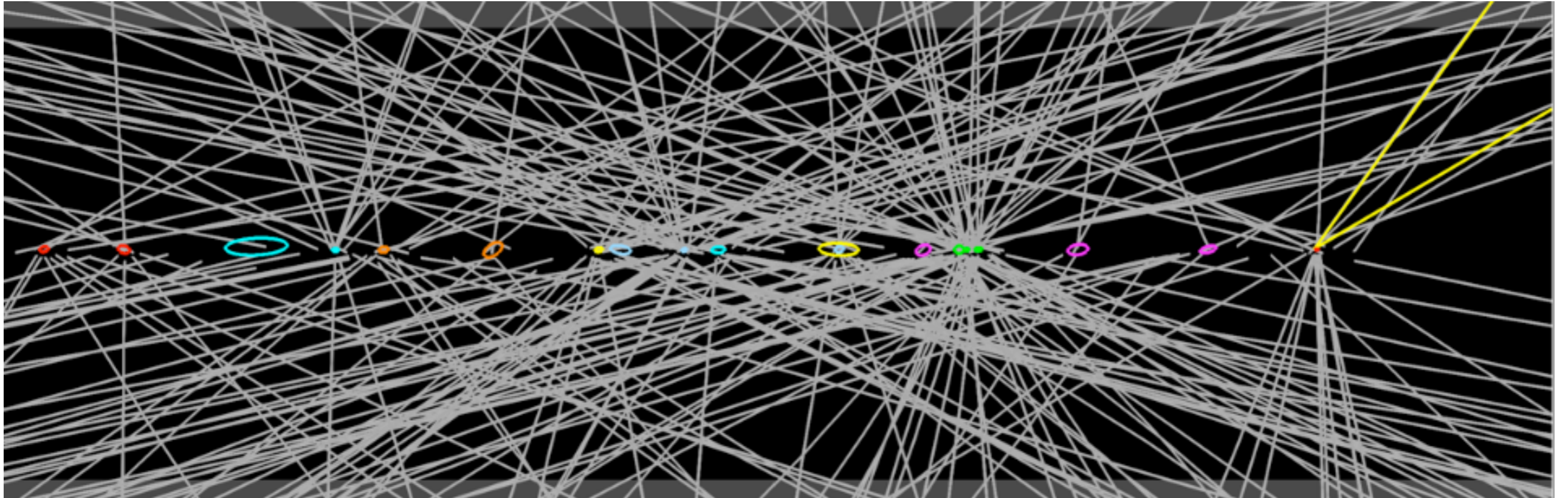

Can be distinguished for charged tracks
but not easily for calorimeter energy deposits

Particle flow principle

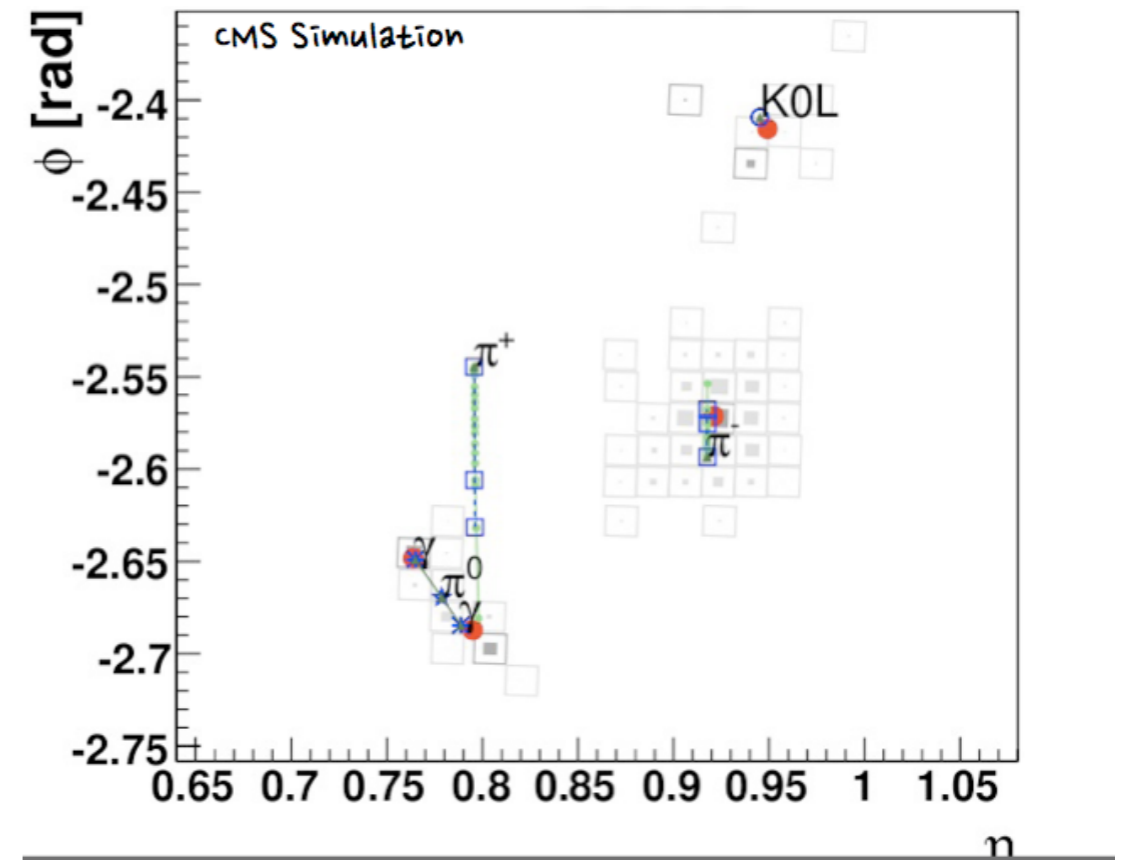
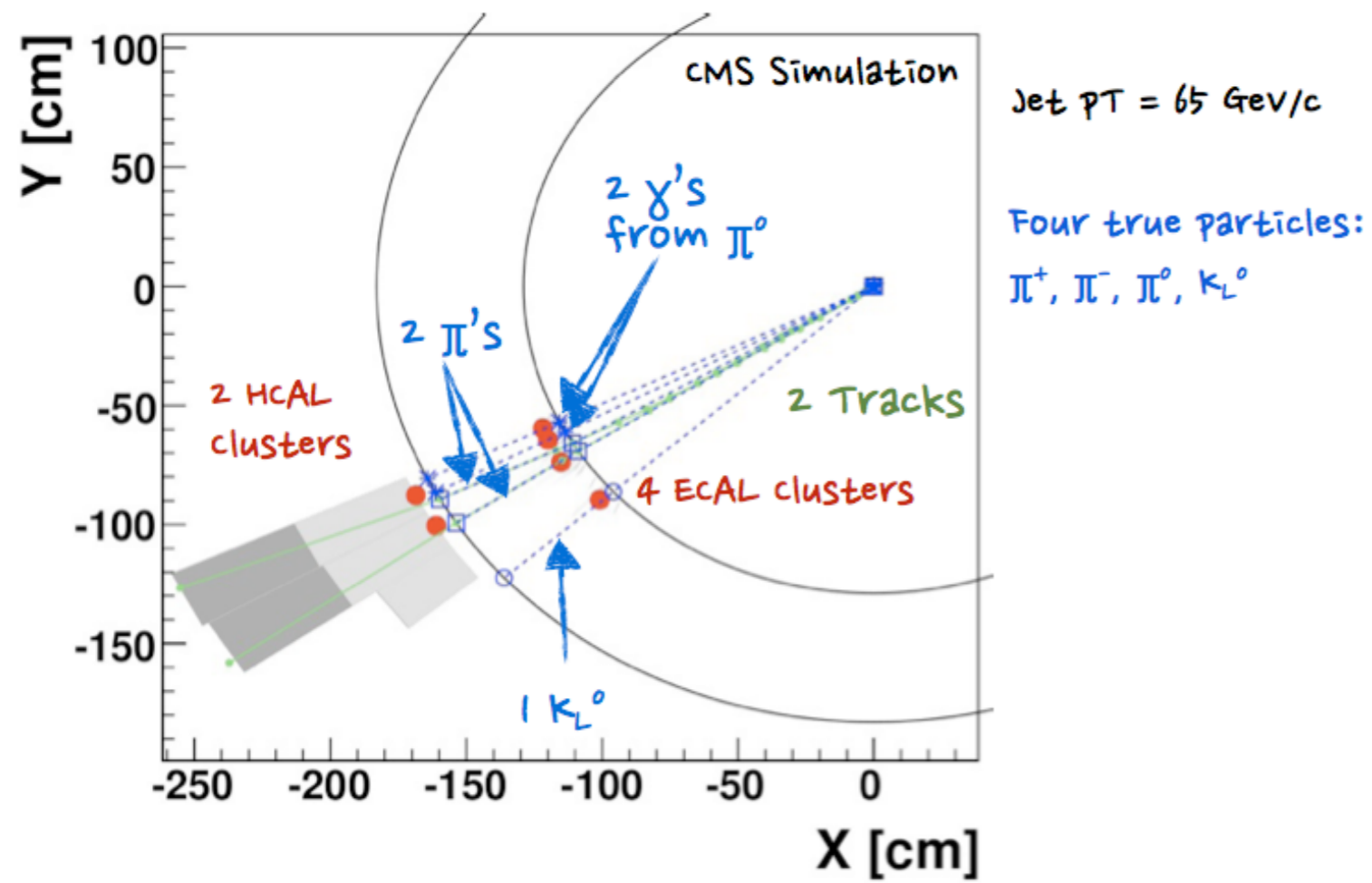

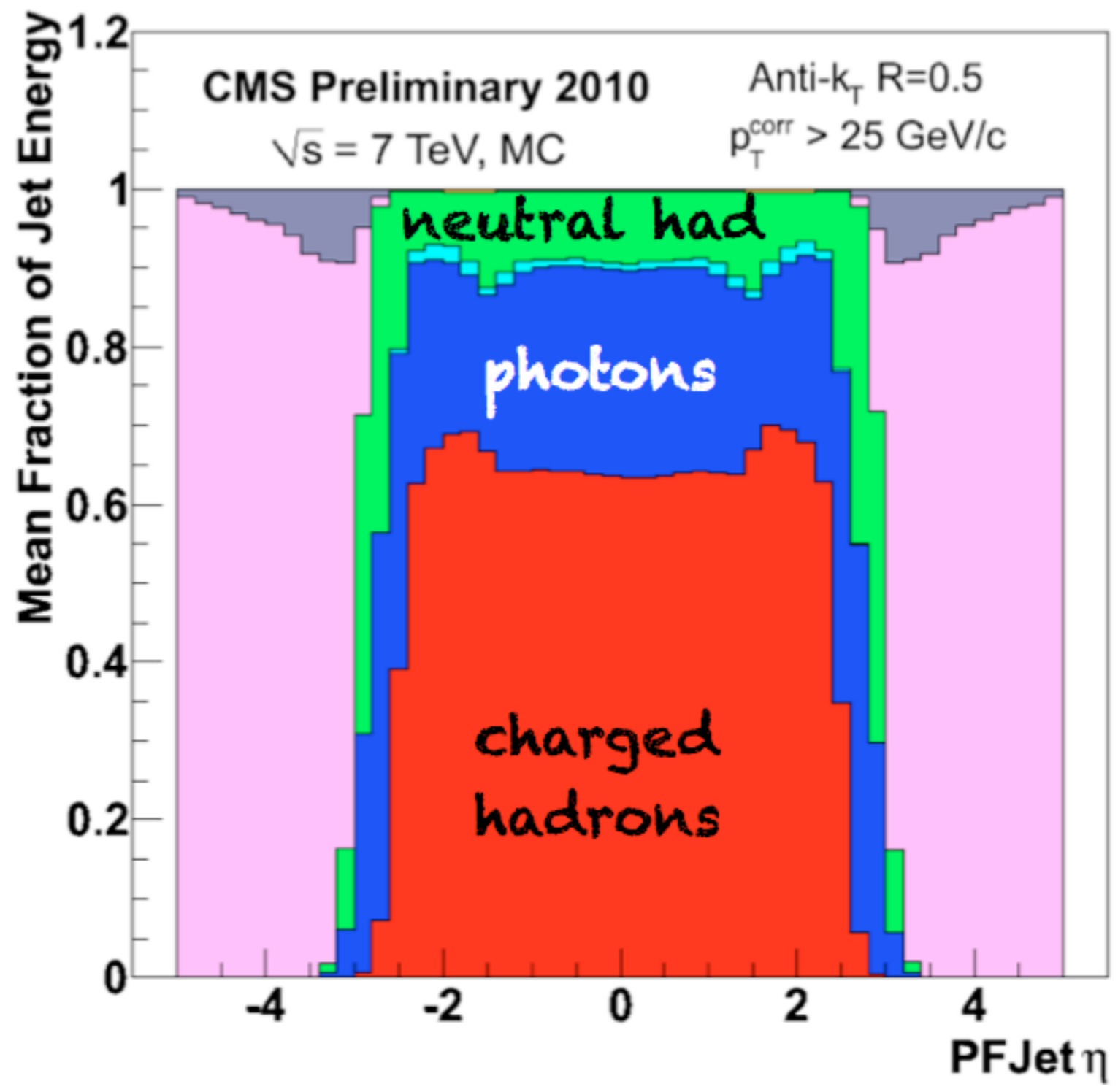

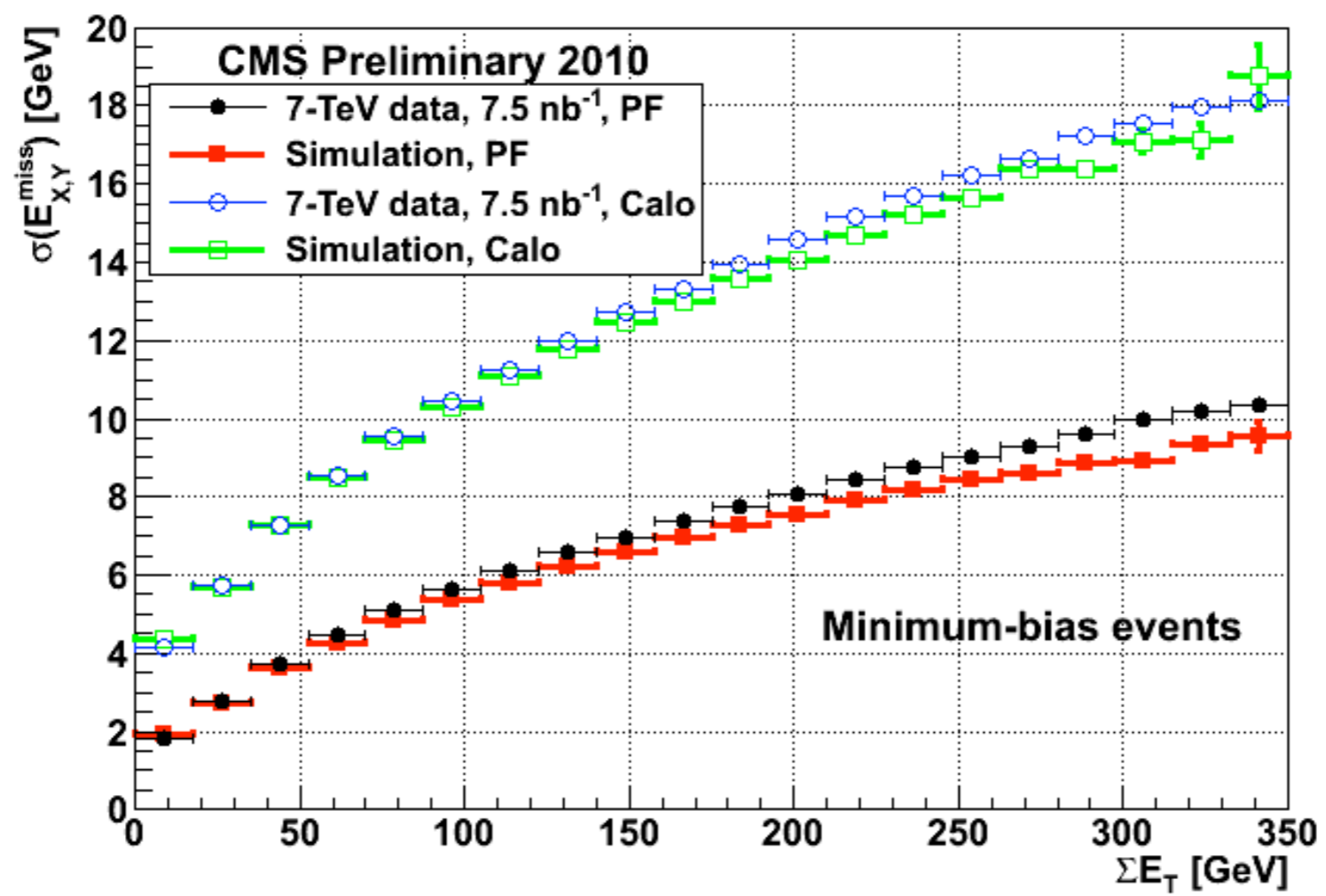

some references/links

- PDG reviews on particle interactions and particle detectors <http://pdg.lbl.gov/>
- C.Lippmann, hep-ex arXiv:1101.3276
- ATLAS, CMS, LHCb, ALICE performance papers
- R.Cavanaugh's lectures at HCP school 2012
- D.Bortoletto's lectures for CERN summer student
- W.Riegler's CERN academic training lectures, February 2014