

LS2 planning meeting

A.Tauro

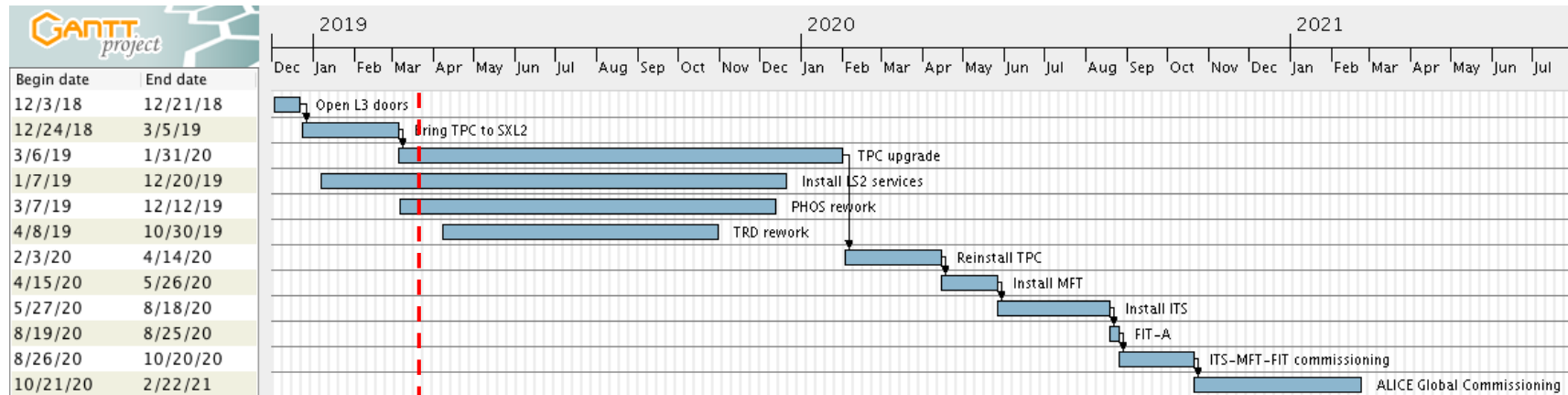

LS2 master plan



EN-EL interventions

- ~~AUG on Monday 25 March 2019 – no access on site (both surface and underground)~~
- Diesel maintenance: 1 Apr 2019
- CERN wide 66kV maintenance: 28 May 2019 to 19 July 2019 – reduced consumption (i.e. no magnets)
- Test secours (10 min): 19 Dec 2019 from 8:00 AM to 11:00 AM
- 18kV, 3.3kV and LV network maintenance:
 - Mon 20 to Wed 22 Jan 2020: 3 days no general services - no access on site (both surface and underground)
 - Thu 23 to Fri 24 Jan 2020: 2 days “Limited access” → details being worked out
- AUG on Monday 27 January 2020 - no access on site (both surface and underground)
- Auto transfer test: 27-29 Apr 2020
- BIW test: 5 and 6 Oct 2020 from 18:00 to 00:00 – no access underground

EN-CV interventions

- **Big maintenance:**
 - SF: from Nov 2019 to mid Jan 2020. NO impact on ALICE as both magnets will be OFF.
 - UW: **stop UX mixed water** for 2 days in week 40/2019 (October).
 - SU: various small perturbations + 1 day **stop all cooling UX** + 1 day **stop all cooling SXL2** in week 16/2020 (April).
- **Small maintenance:**
 - UW: from mid Aug 2020 to mid Sep 2020. **Stop mixed water UX** for 1 day in week 37/2020 (September).
 - SF+SU: weeks 45-47/2020: cleaning towers (stop SF 1 week) + 1 day **stop all cooling UX**.
- **Ventilation:**
 - SG2: w7/2019 - Done
 - Gas extraction: w8/2019 - Done
 - UX25 cavern: May 2020 (tbc)
 - MCH and MTG: Apr 2020 (tbc)
 - L3: Apr 2020 (tbc)
 - ITS: Apr 2020 (tbc)
- **Raw water:**
 - Test after Apr 2019. Short interruption (1 day), can be used tap water during the test.

CERN Open Days

- 14 and 15 September 2019

DCal/PHOS/CPV schedule

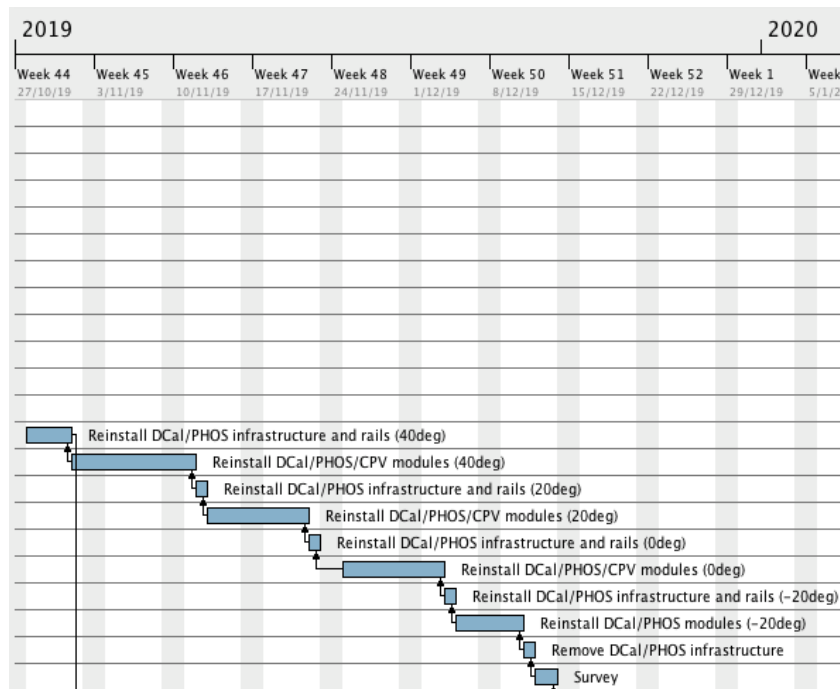
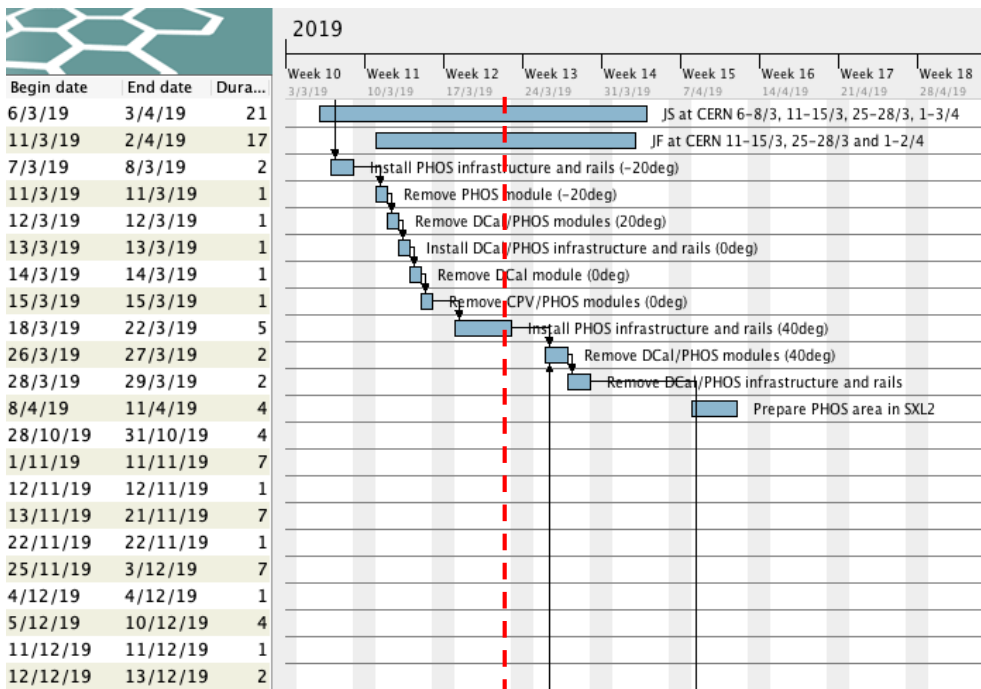

Repair PHOS #4 in SXL2 from mid April

TRD schedule

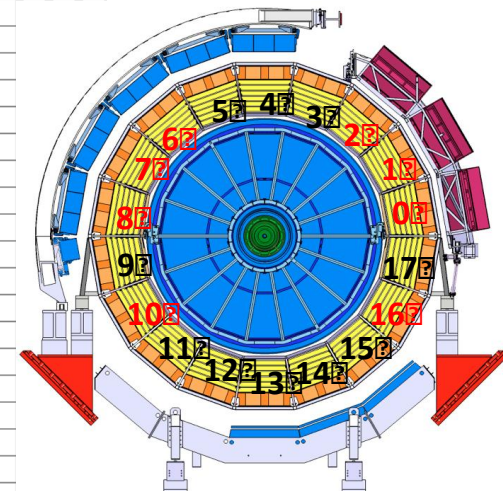
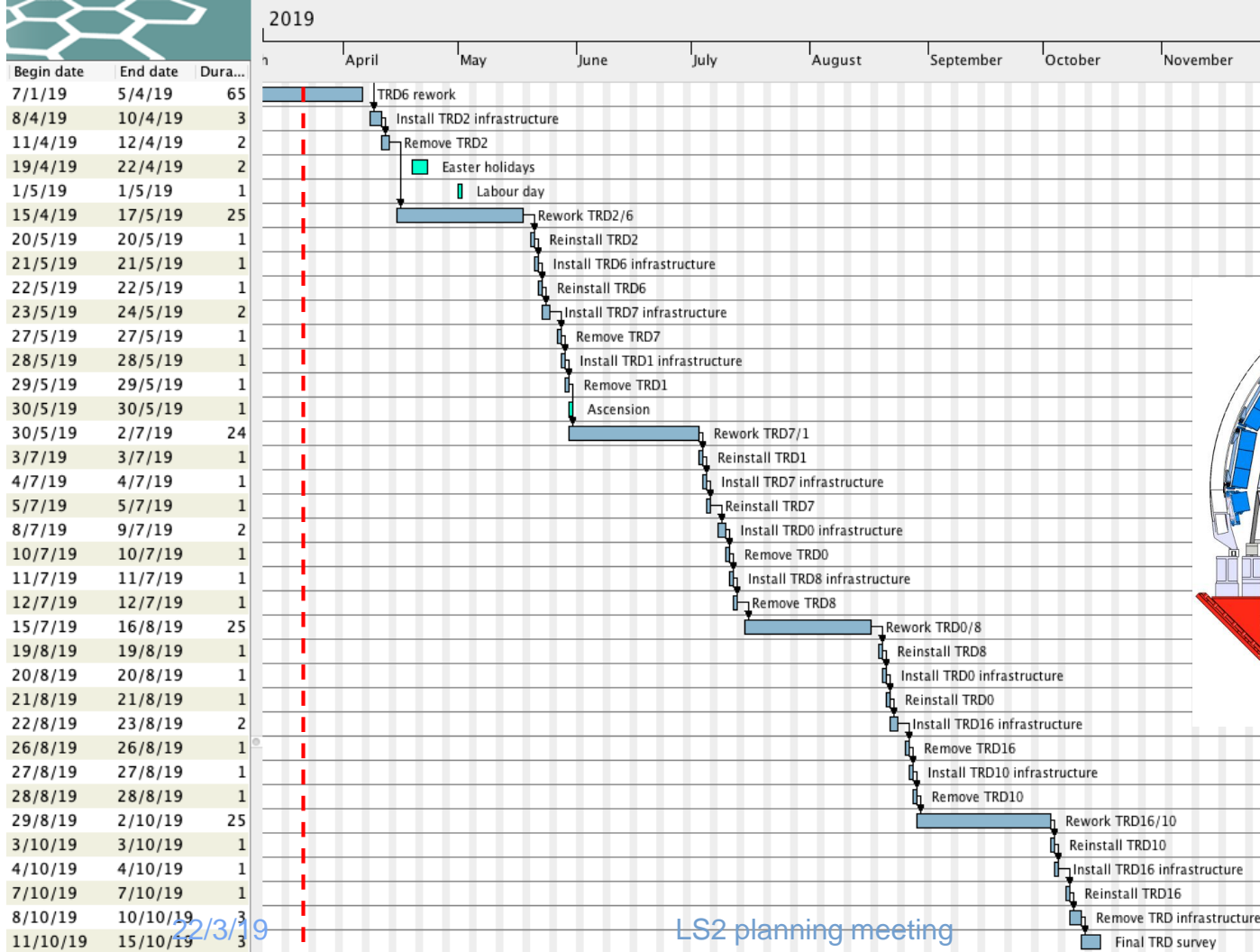

TPC upgrade sequence

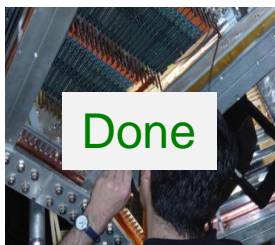

**Remove FEE
outside cleanroom**



Remove ROC



**Survey, sealing,
OVP test**



**Install new FEC +
test**



**TPC ready for
transportation**



**TPC in cleanroom
Irradiation tests**



Install new ROC



Irradiation tests

7 Mar '19

5 Apr

25 Apr (A)
27 Jun (C)

13 May (A)
10 Jul (C)

28 May – 17 Jun (A)
23 Jul – 8 Aug (C)

11 Sep (A)
26 Sep (C)

19 Dec

4 Feb '20

TPC schedule – Mar-Apr

New dates

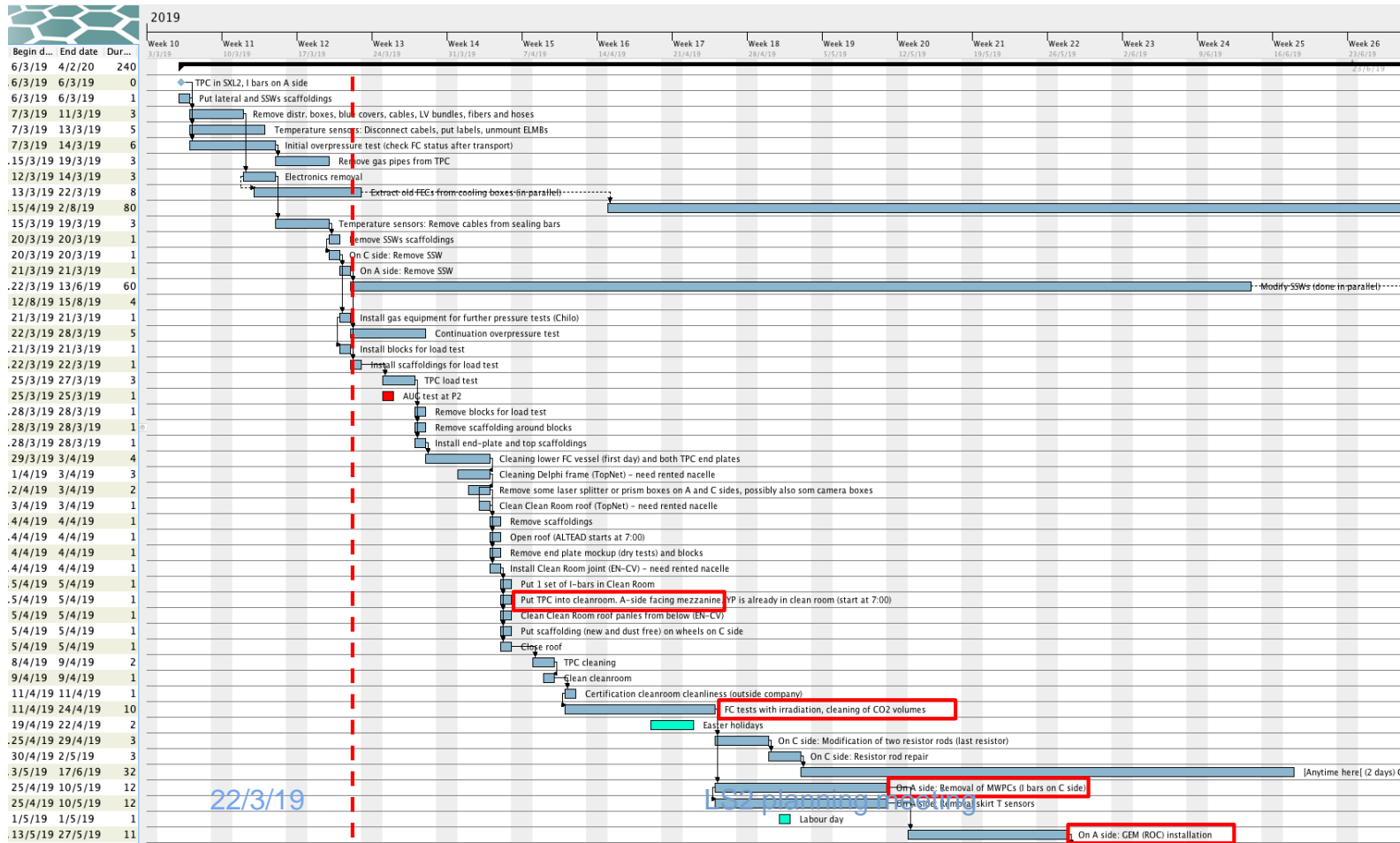

22/3/19

Self-planning

On A side: Removal of MWPCs (I bars on C side)

On A side: GEM (ROC) installation

Copper cables (EN-EA)



Begin date	End date	Dura...
11/3/19	14/3/19	4
15/3/19	26/3/19	8
27/3/19	29/3/19	3
1/4/19	5/4/19	5
8/4/19	12/4/19	5
15/4/19	19/4/19	5
22/4/19	26/4/19	5
29/4/19	14/5/19	12
15/5/19	24/5/19	8
27/5/19	31/5/19	5
3/6/19	7/6/19	5
10/6/19	14/6/19	5
17/6/19	20/6/19	4
21/6/19	21/6/19	1
24/6/19	28/6/19	5
1/7/19	5/7/19	5
8/7/19	17/7/19	8
18/7/19	19/7/19	2
22/7/19	23/7/19	2
18/3/19	19/7/19	90

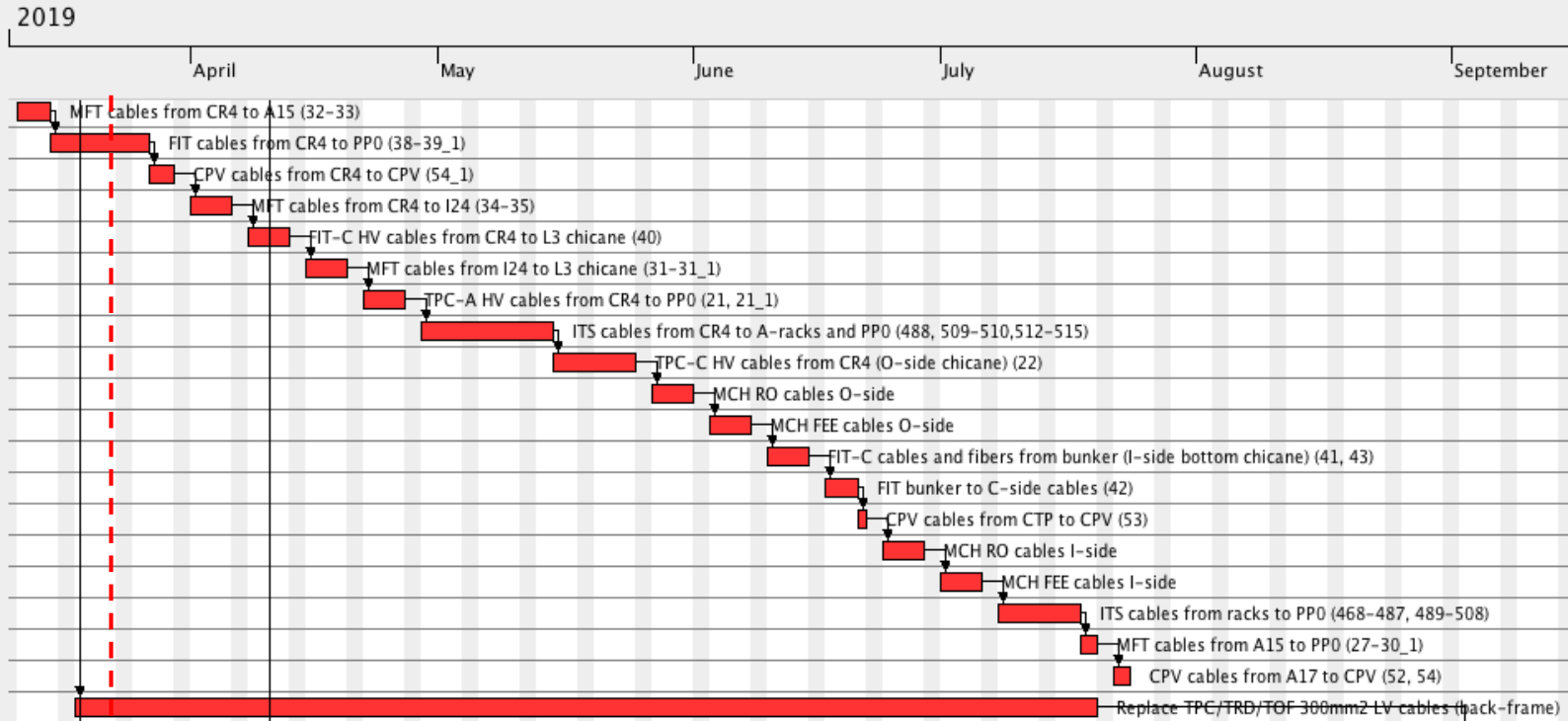

Copper cables – dates completion connectors + test (EN-EA)

Cavern:

- TPC : 29/10/2019
- ITS : 19/11/2019
- MFT : 27/11/2019
- FIT : 3/12/2019
- CPV : 21/10/2019
- MCH : 10/07/2019

This is a proposal, please check these dates

Miniframe:

- TPC : 03/02/2020
- ITS : 04/03/2020
- MFT : 11/03/2020
- FIT : 03/03/2020

Optical fibers (EN-EL)

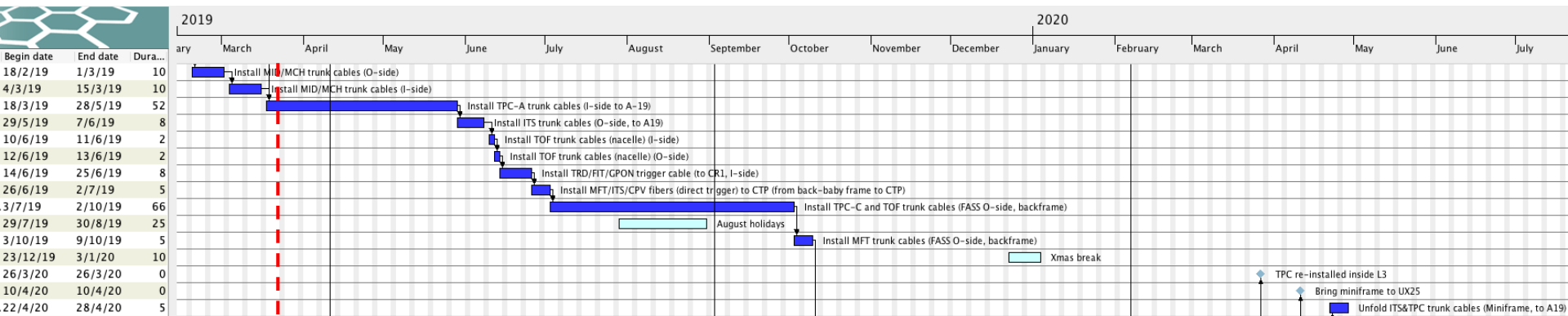

Day-by-day sequence w12



UX25 activities w12 – Mon 18 Mar 2019

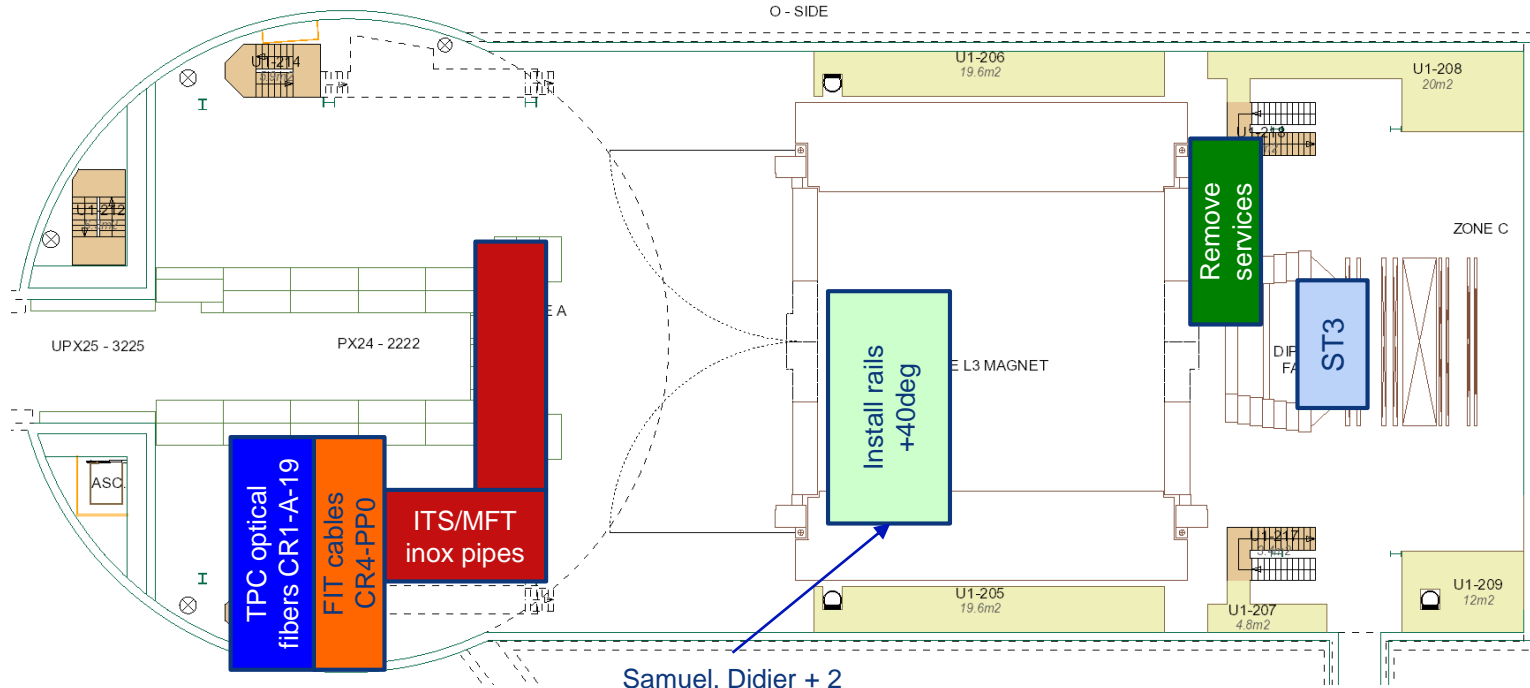

Samuel, Didier + 2
from Asif team

LS2 planning meeting

SXL2 activities w12 – Mon 18 Mar 2019

Install gas equipment for further pressure tests (Chilo)

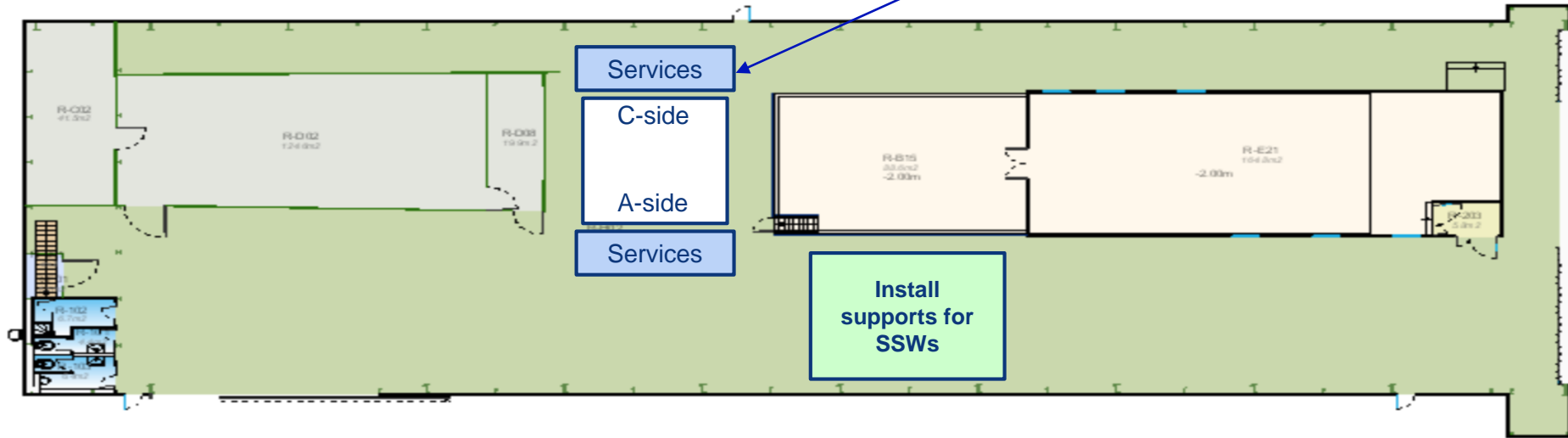

UX25 activities w12 – Tue 19 Mar 2019

Asif team (2 persons): storage Yannick's screws in Dider's atelier

ALTEAD: transport PHOS M3 to b.167 (14:00)

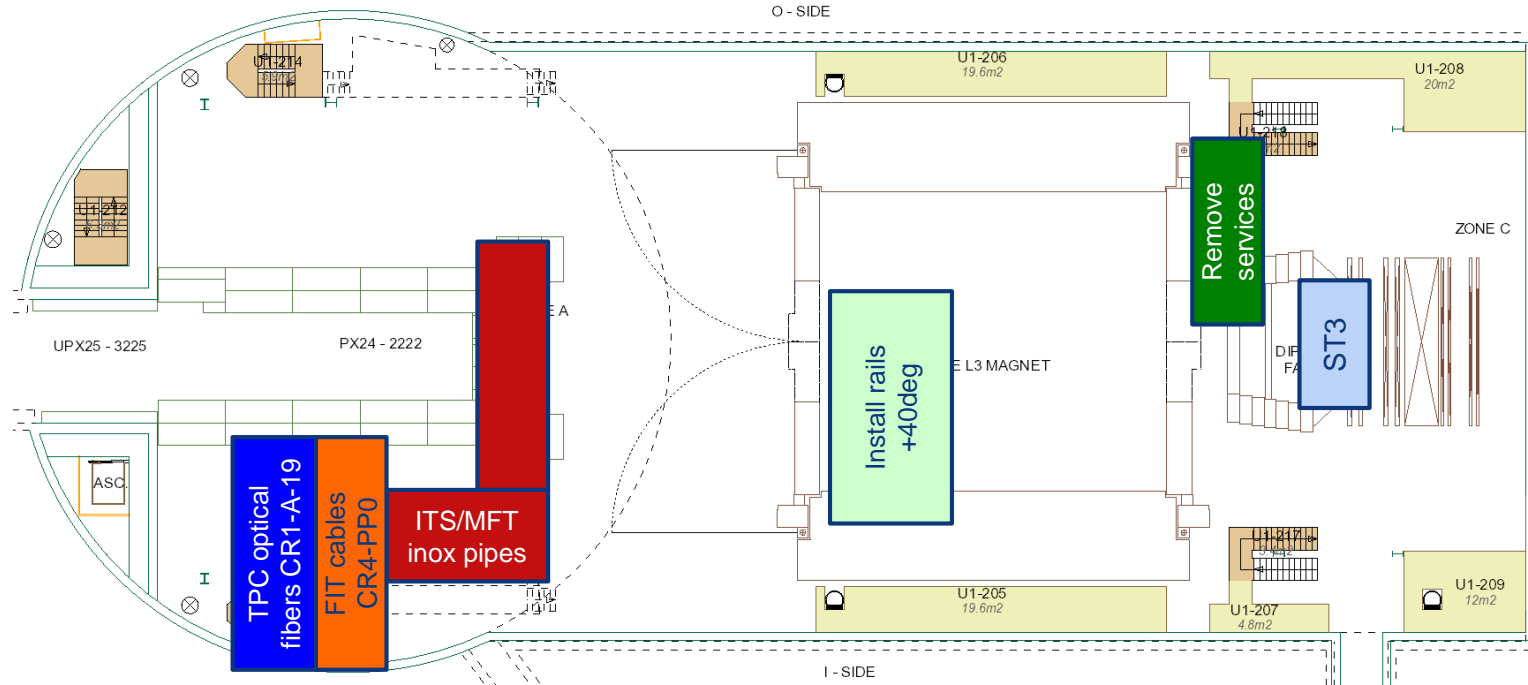

SXL2 activities w12 – Tue 19 Mar 2019

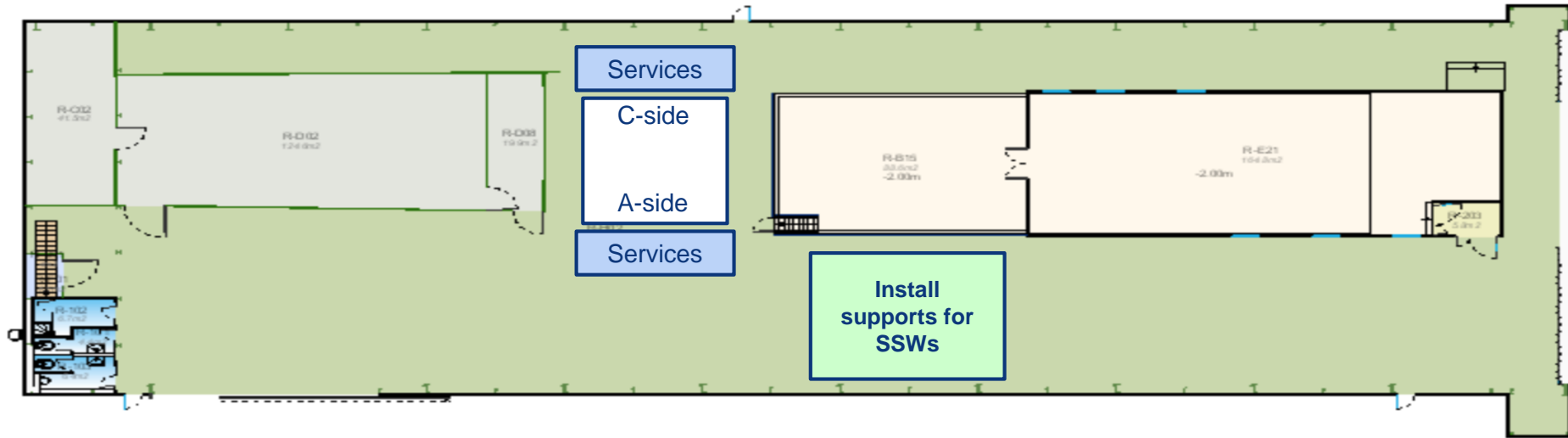

UX25 activities w12 – Wed 20 Mar 2019

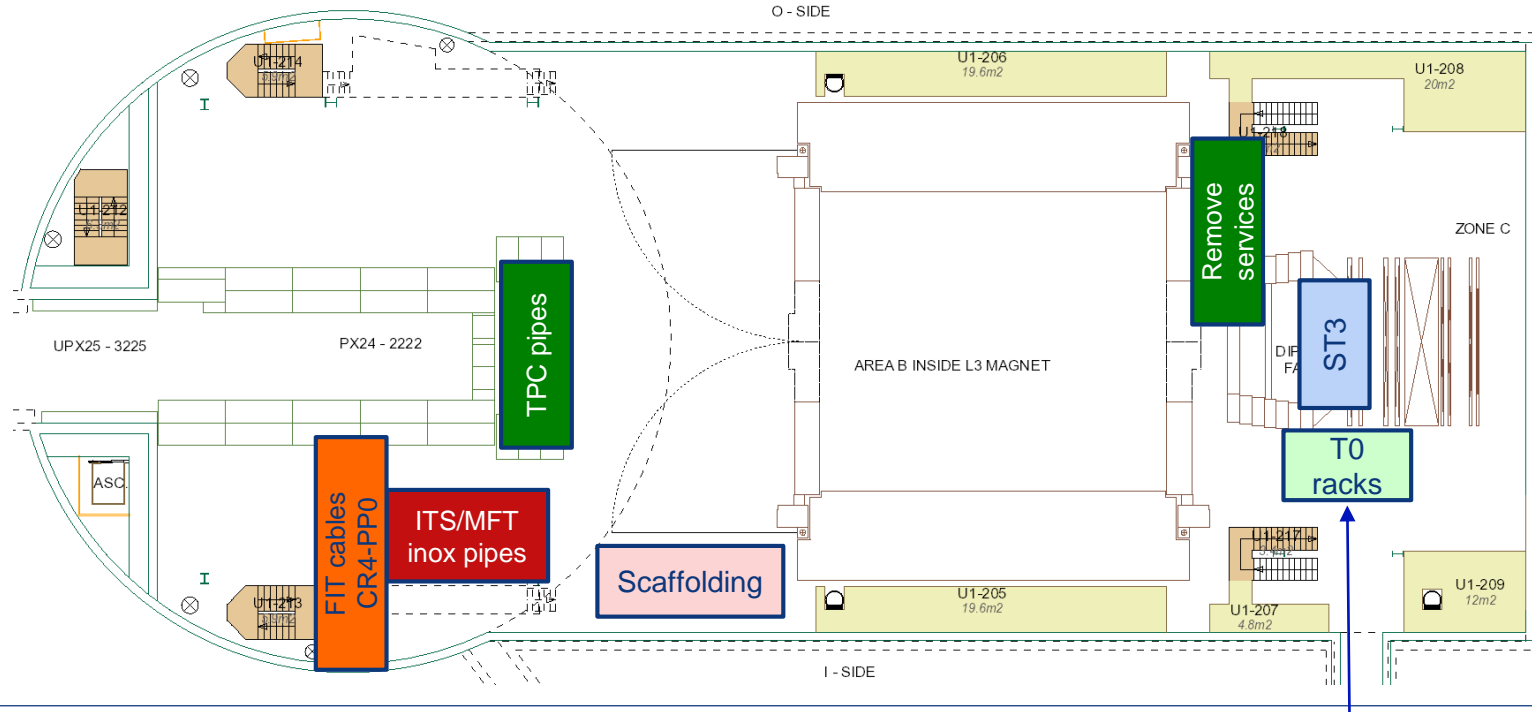

SXL2 activities w12 – Wed 20 Mar 2019

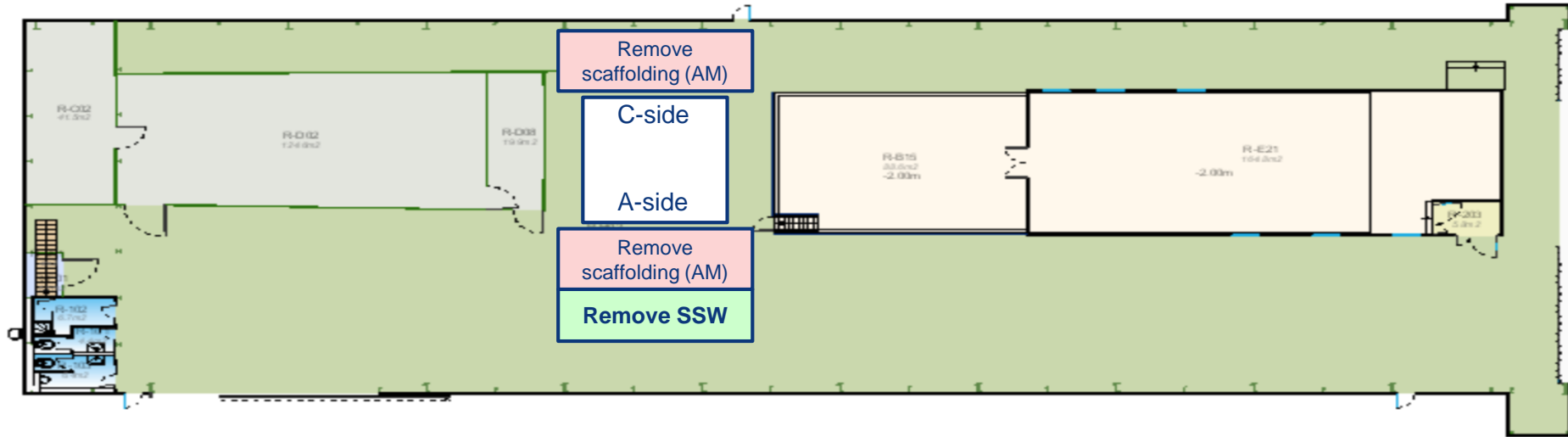

UX25 activities w12 – Thu 21 Mar 2019

Facebook live at 16:00

Delivery 10 drums (LV cables)

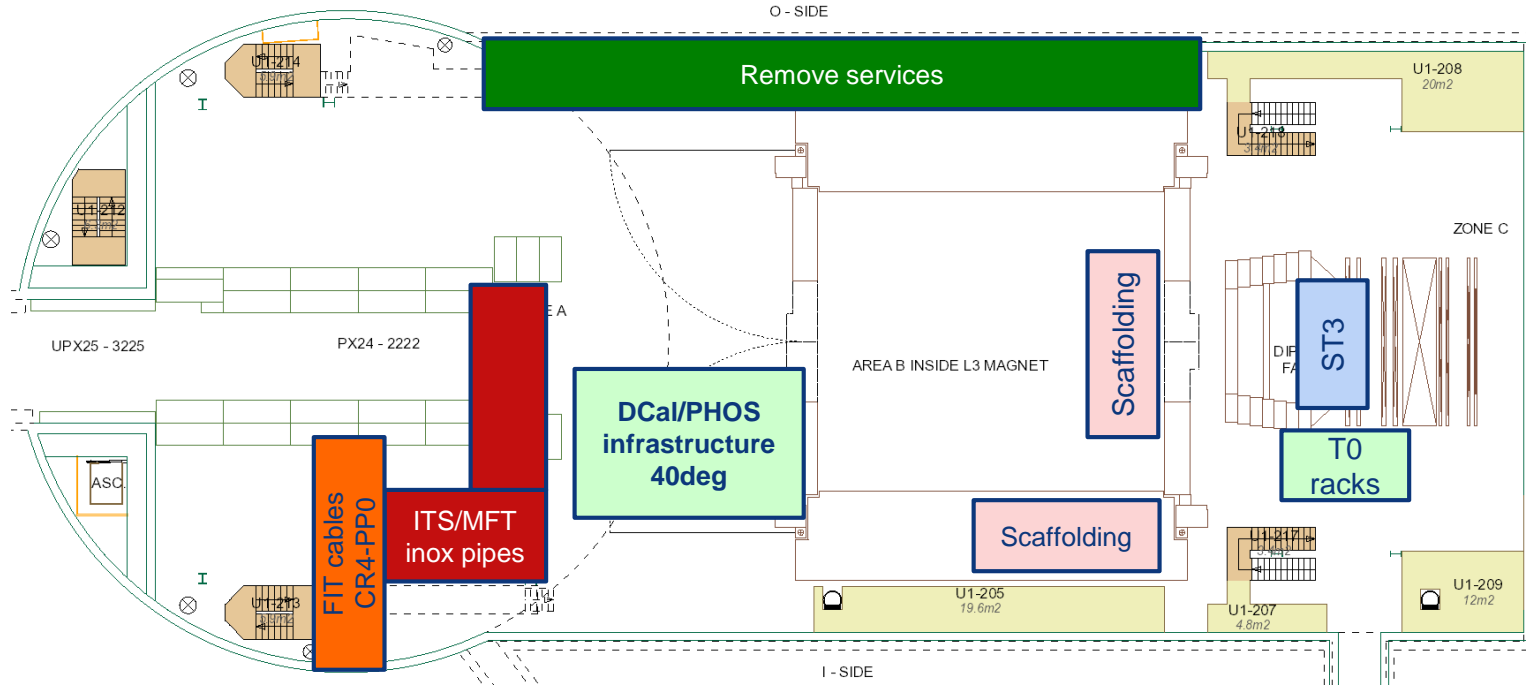

SXL2 activities w12 – Thu 21 Mar 2019

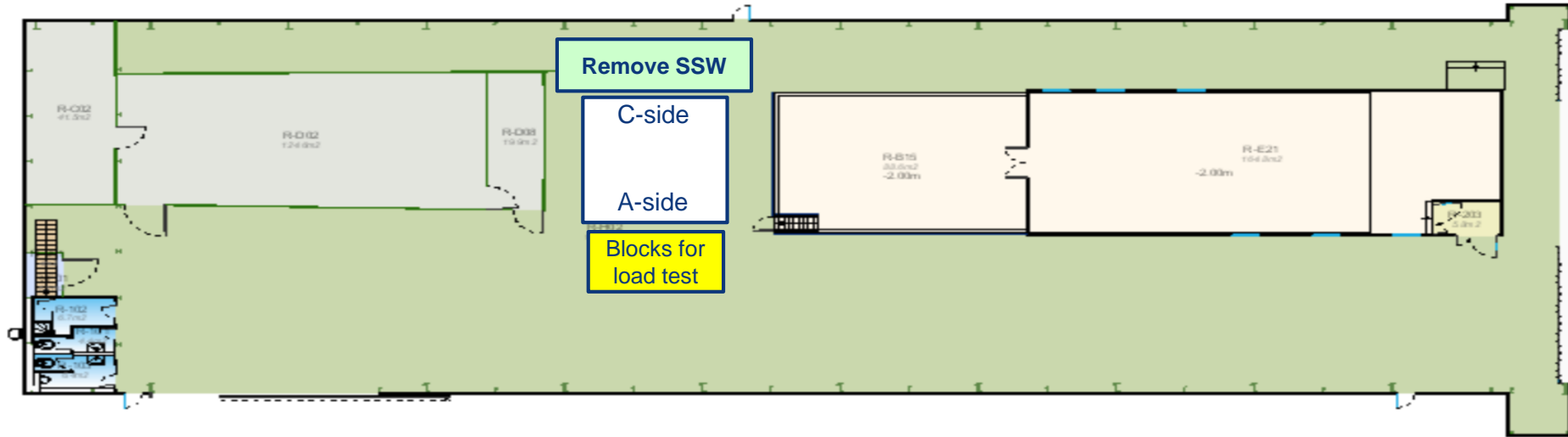

Status w12

- TPC:
 - Both SSWs removed
 - Preparation load test
- Cavern:
 - DCal/PHOS infrastructure (40deg) ready
 - FIT rack C35 installed

Highlights w12 – preparation TPC load test

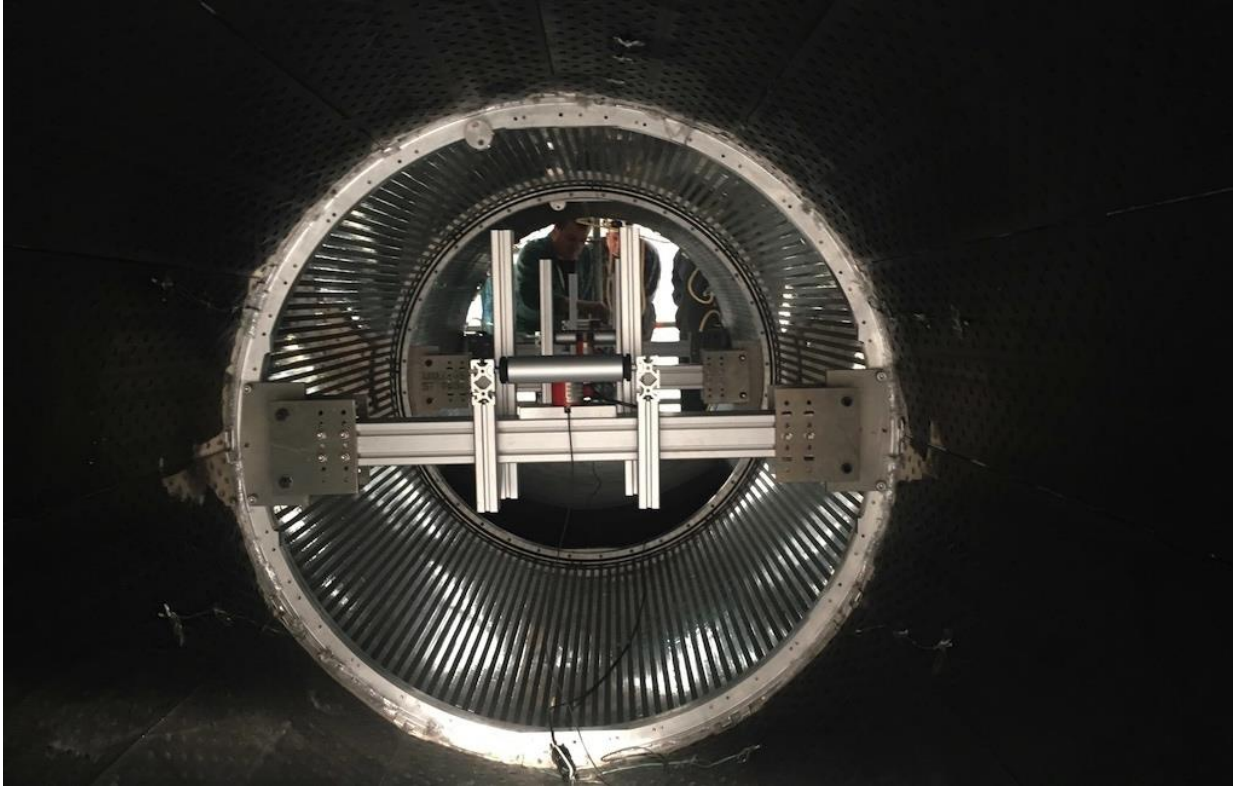

Highlights w12 – both TPC SSWs removed

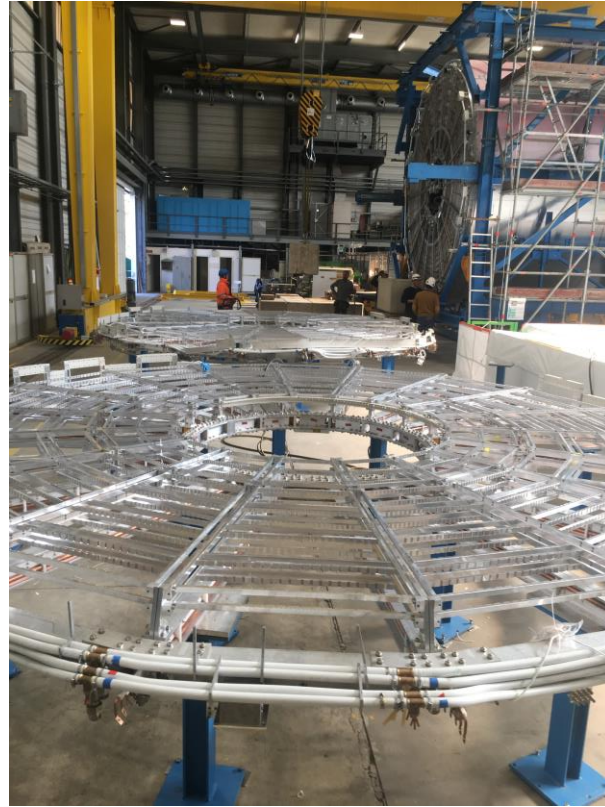

Highlights w12 – PHOS M3 transported to b.167



Highlights w12 – PHOS/DCal infrastructure 40deg



Highlights w12 – T0 racks

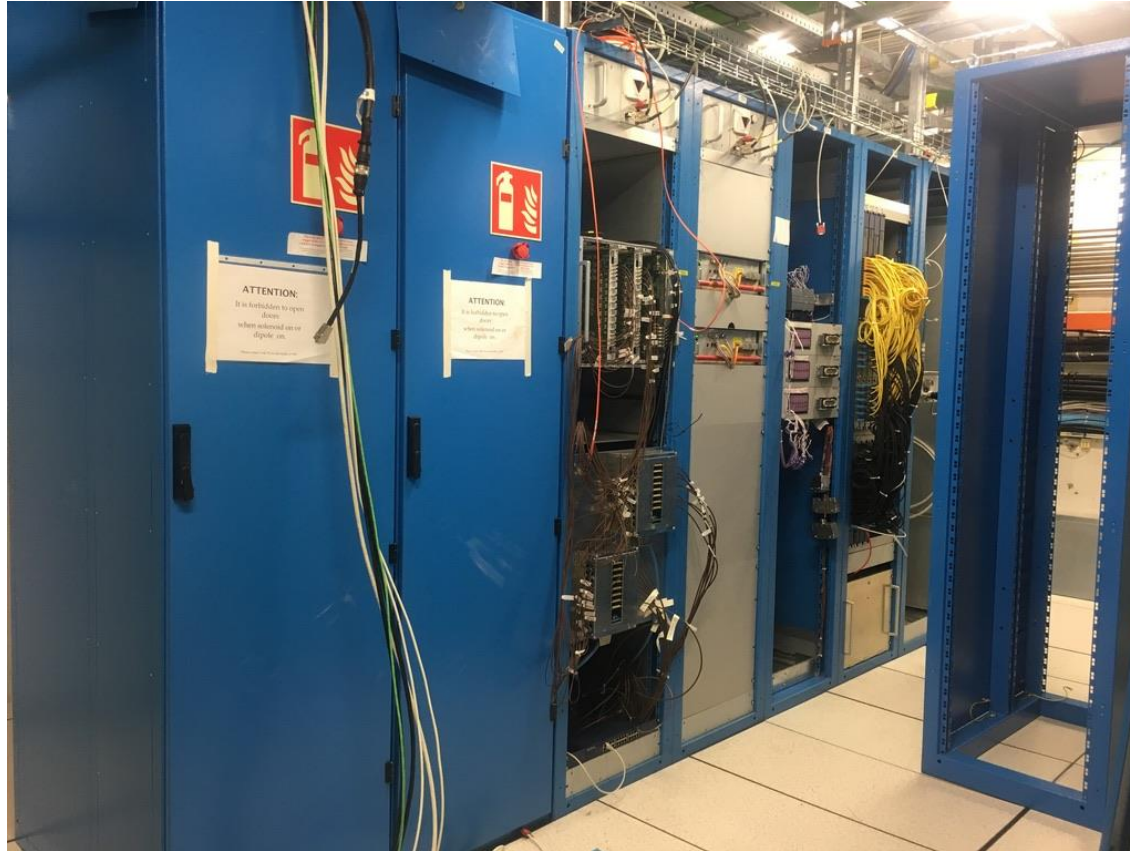

Highlights w12 – Installation TPC optical fibers



Highlights w12 – ITS back-frame services removed



UX25 activities w12 – Fri 22 Mar 2019

ALTEAD: bring TRD platform to SX2

ALTEAD: evacuate cables from C/O side

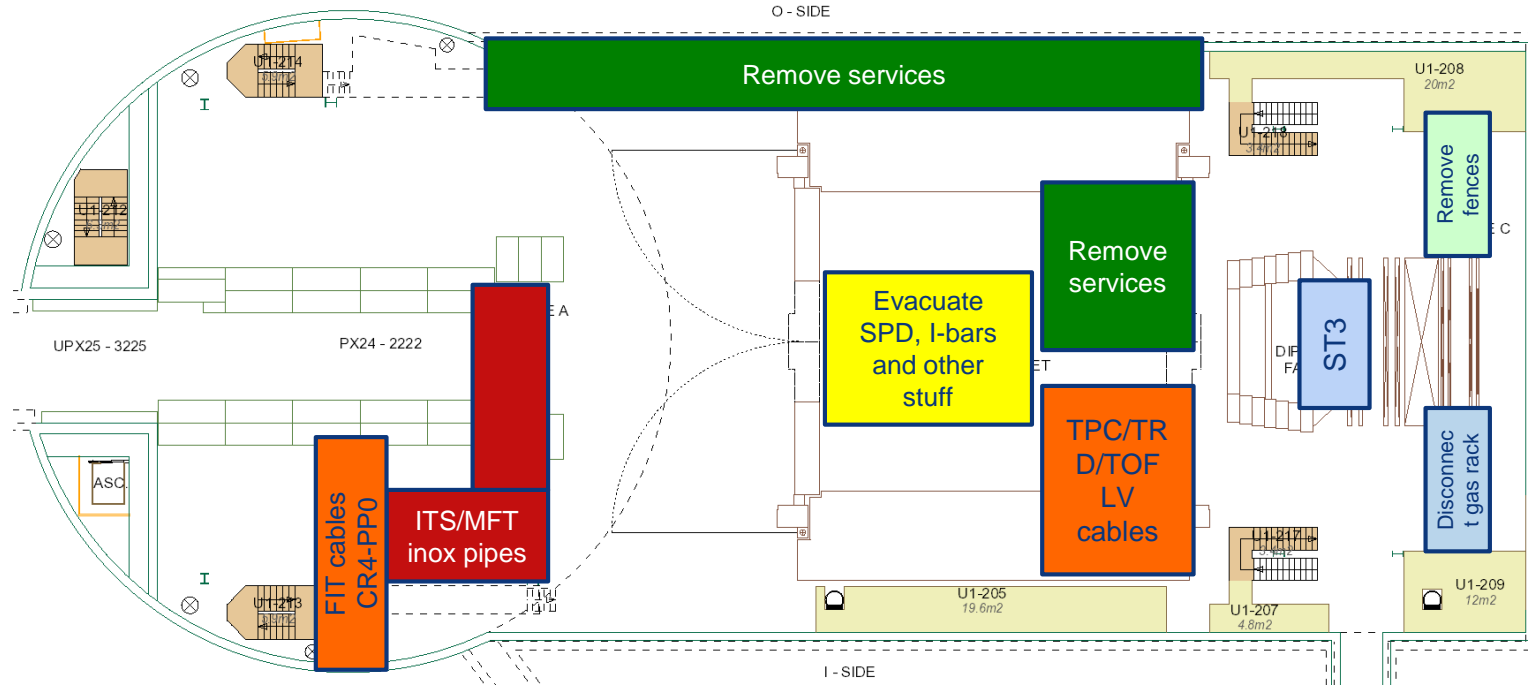

SXL2 activities w12 – Fri 22 Mar 2019

ALTEAD: install beam for load test

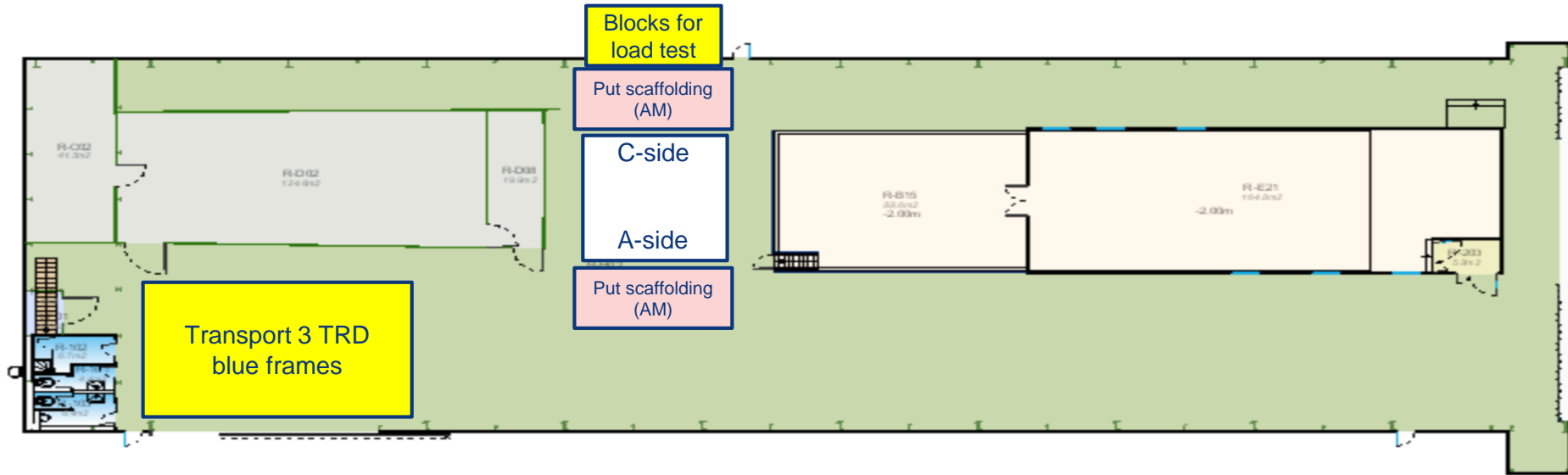

Day-by-day sequence w13



UX25 activities w13 – Mon 25 Mar 2019

TRD platform modification (Didier, Philippe - SX2)

Jean-Se and Jean-Francois at CERN: 25-28/3

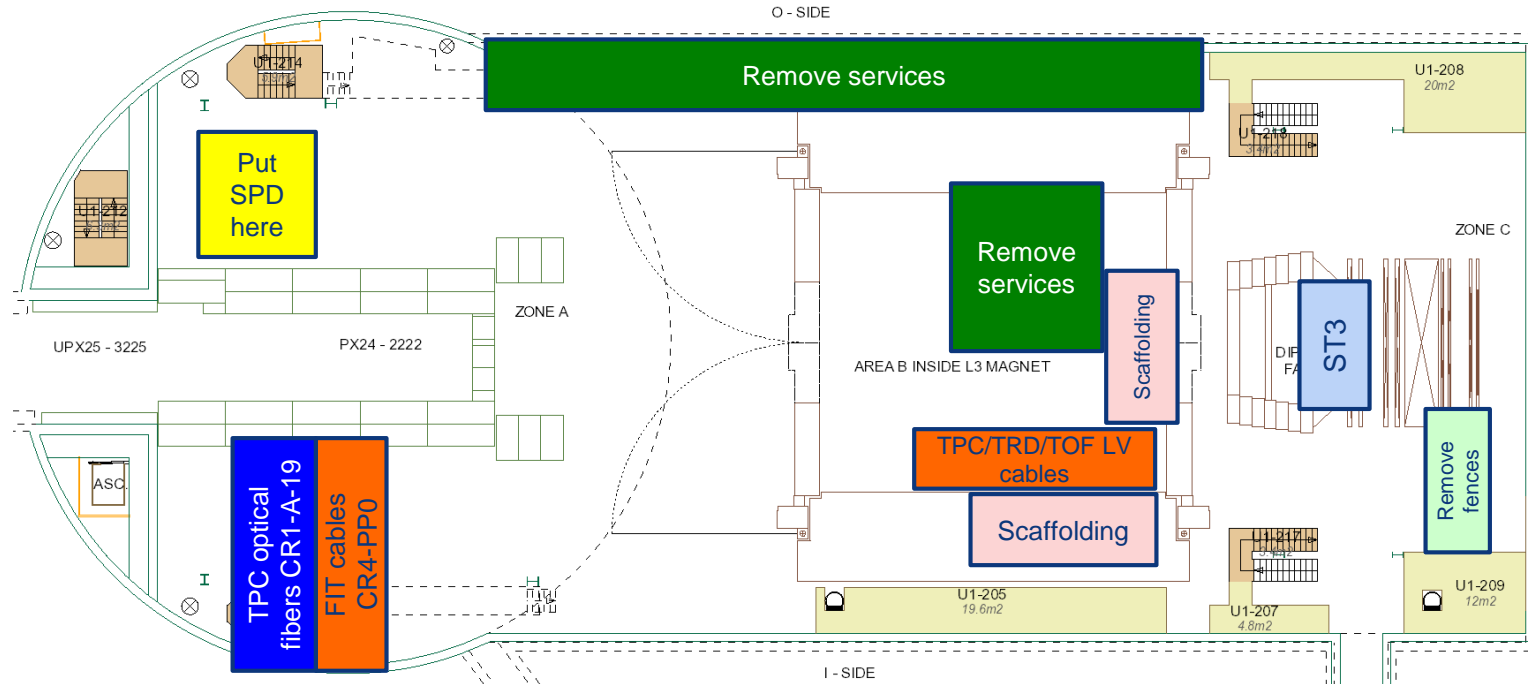

SXL2 activities w13 – Mon 25 Mar 2019

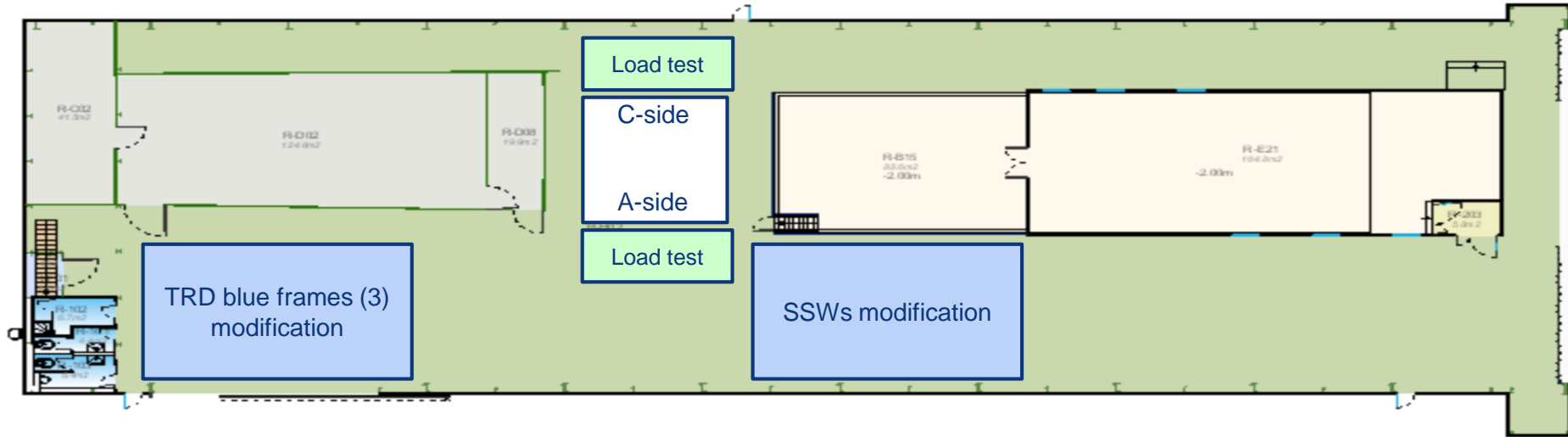

UX25 activities w13 – Tue 26 Mar 2019

HSE revalidation PPEs in 3294 R-002

ALTEAD: transport TRD table outside SX2 and TRD blocks inside SX2

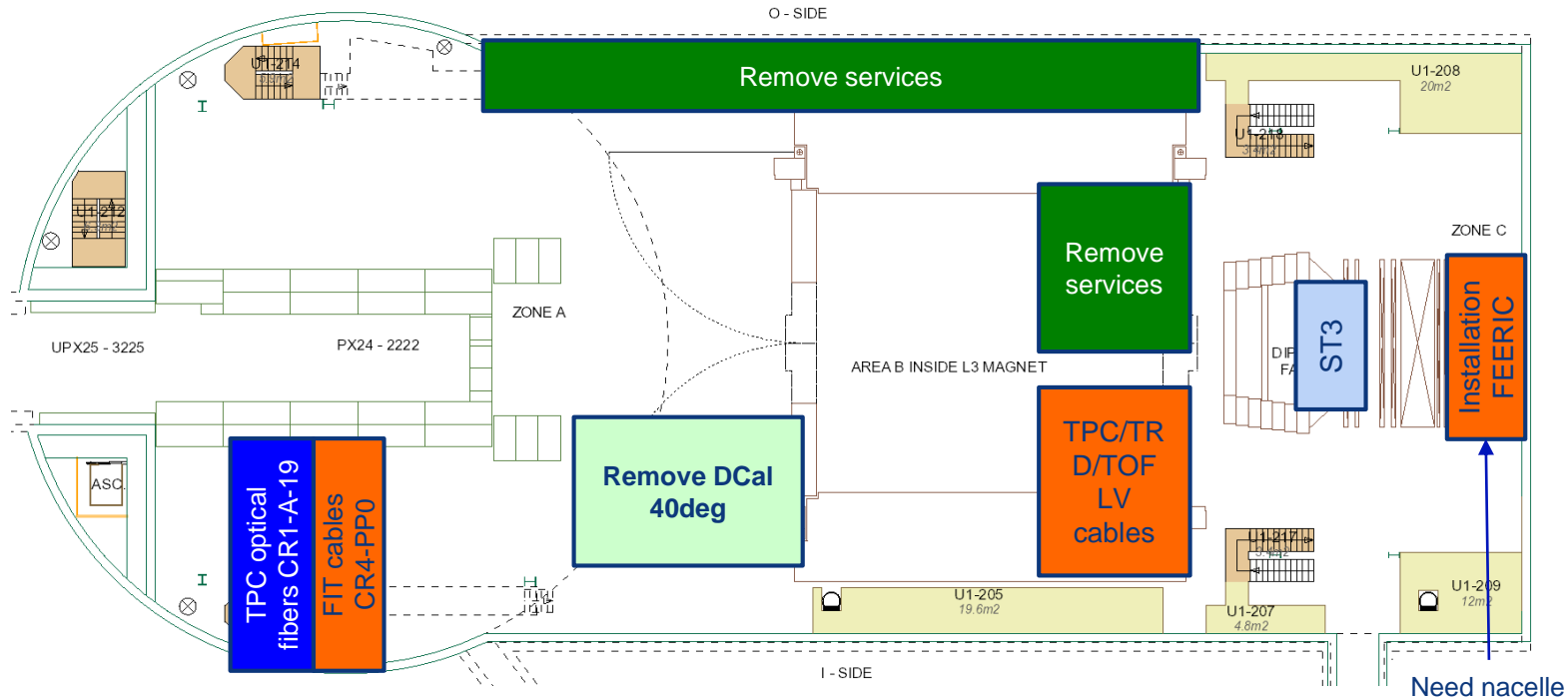

SXL2 activities w13 – Tue 26 Mar 2019

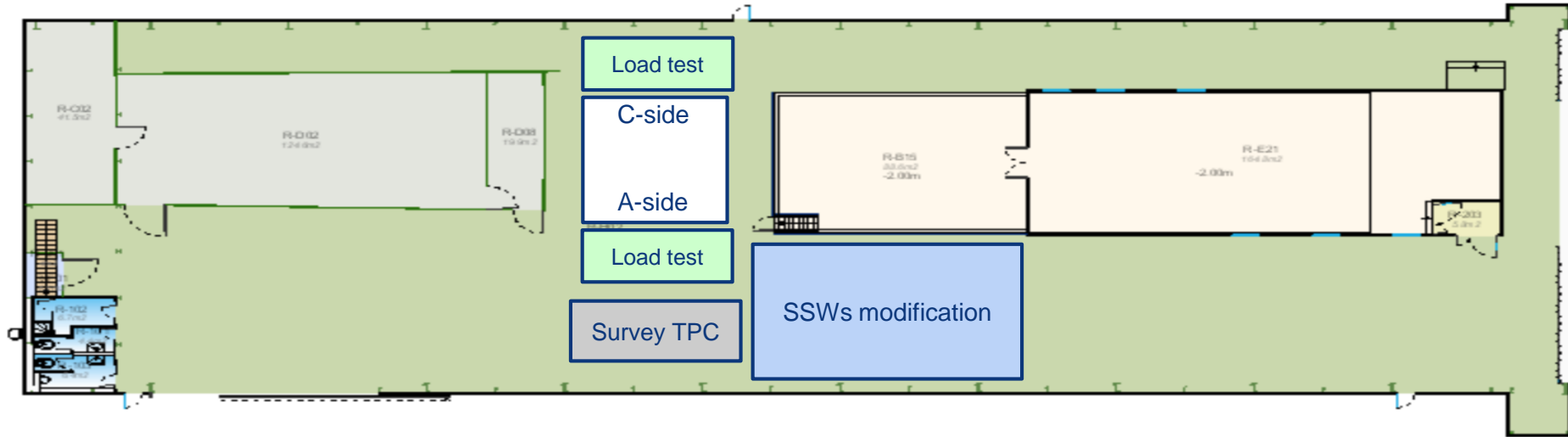

UX25 activities w13 – Wed 27 Mar 2019

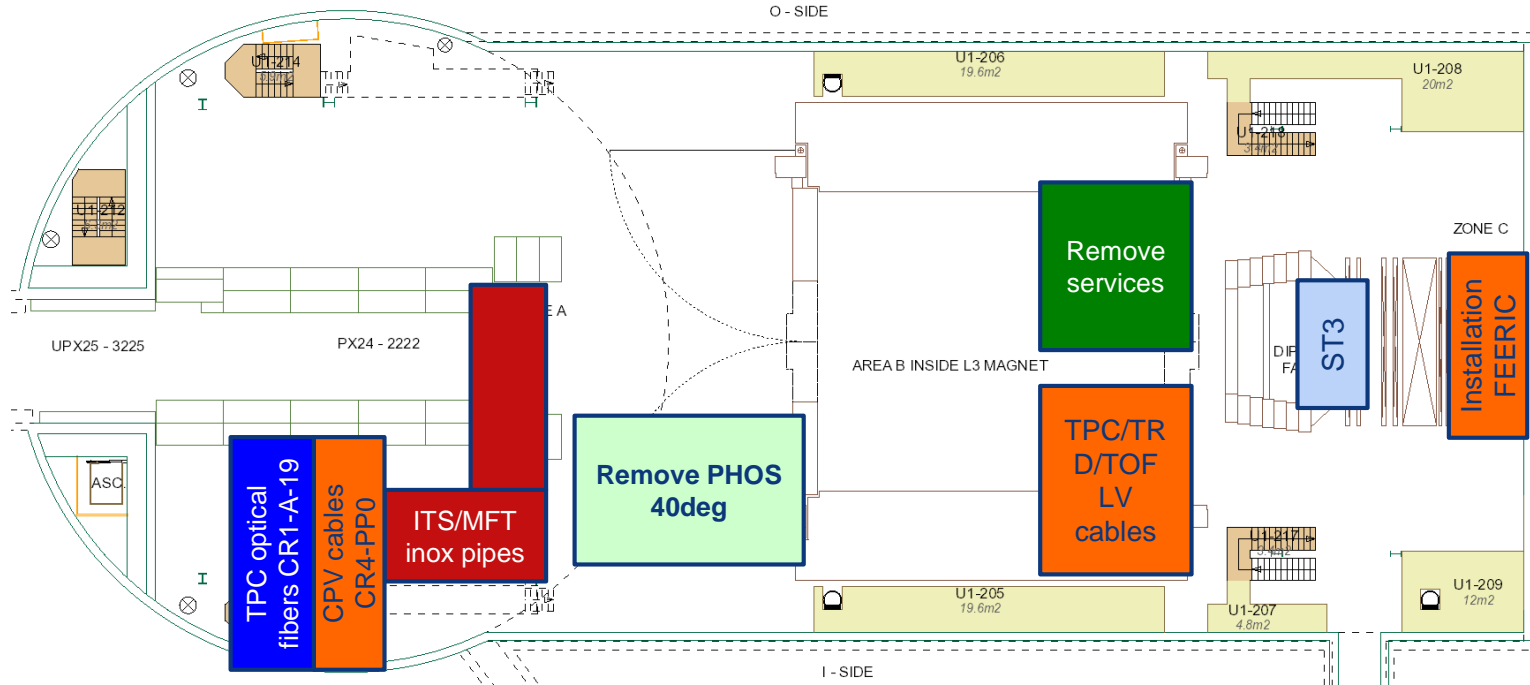

SXL2 activities w13 – Wed 27 Mar 2019

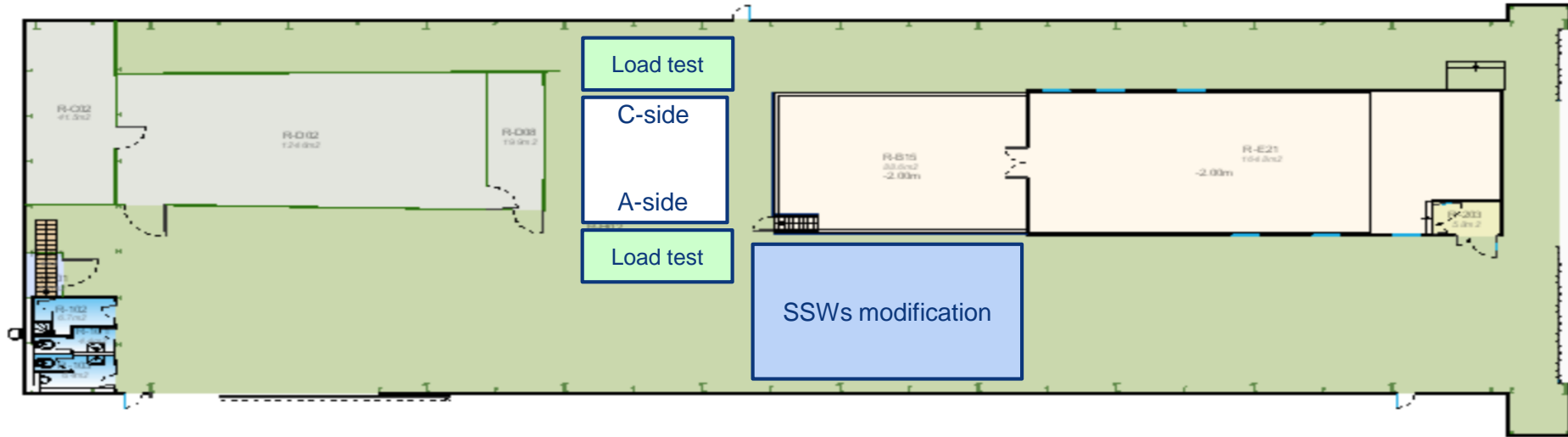

UX25 activities w13 – Thu 28 Mar 2019

Remove miniframe services (pipes, cables) – Pakistani team (whole week)

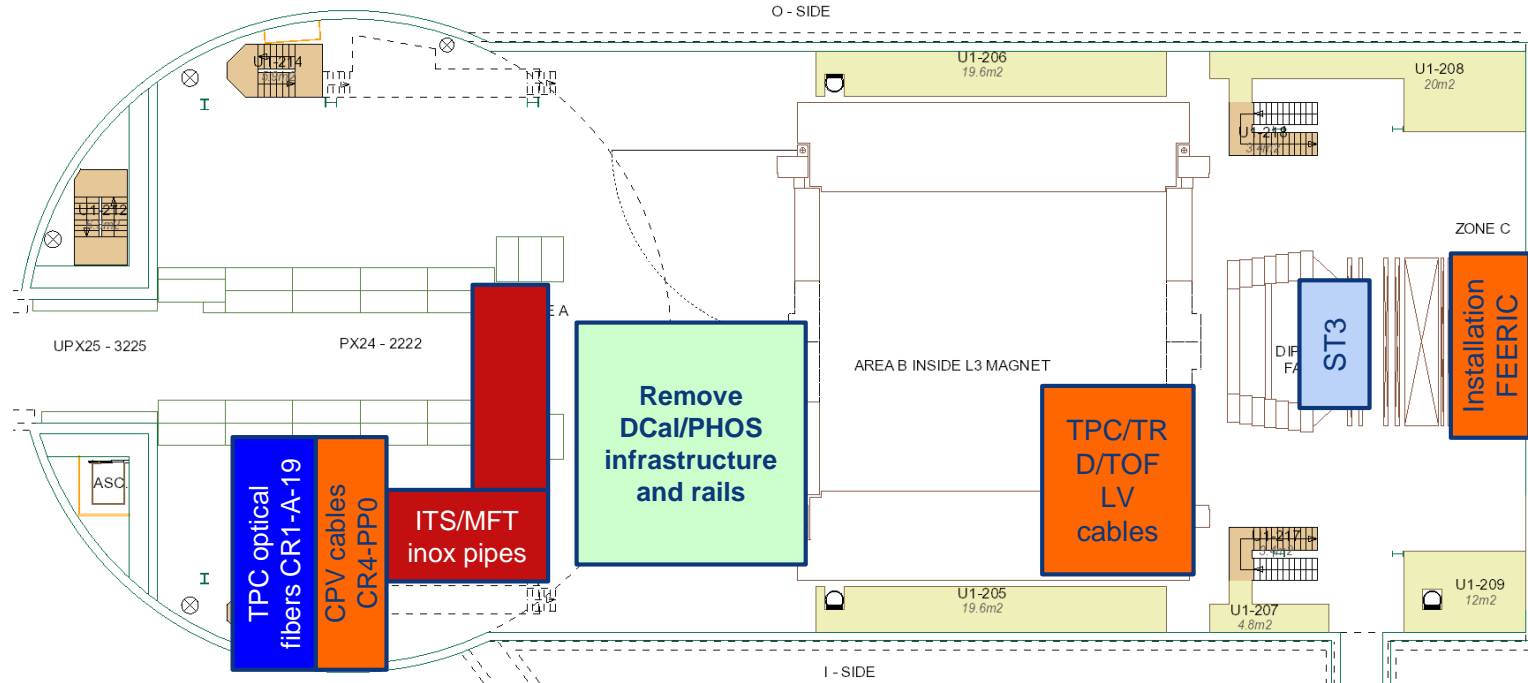

SXL2 activities w13 – Thu 28 Mar 2019

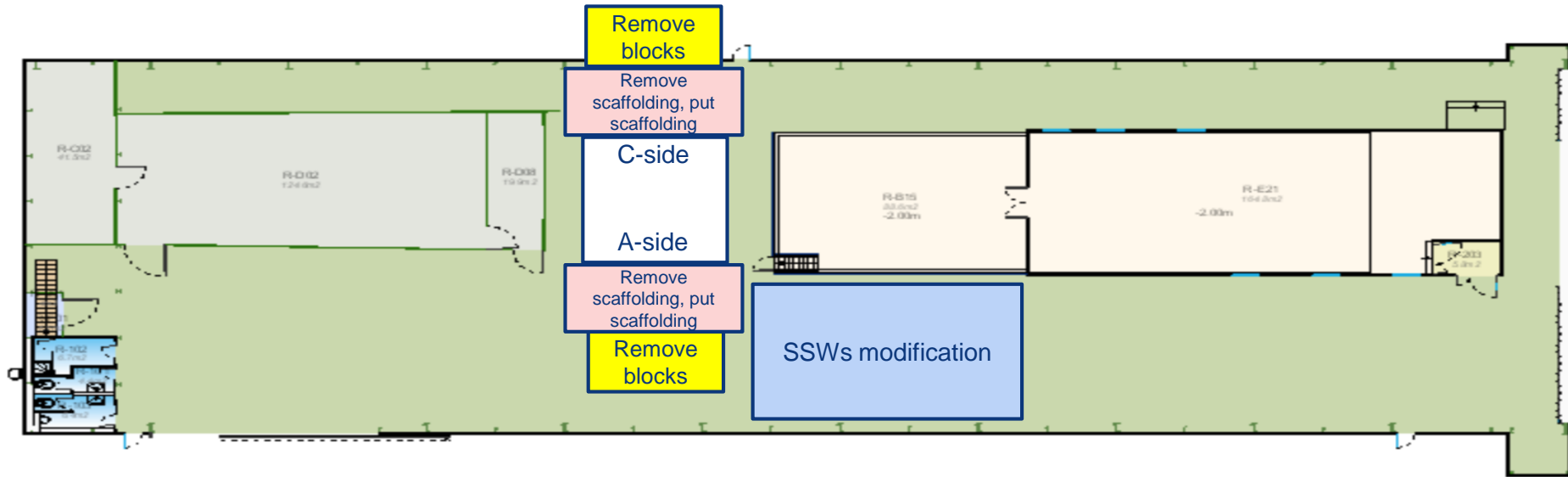

UX25 activities w13 – Fri 29 Mar 2019

Installation 4m3 bin for copper cable, empty 10m3 bin – use it for LV cables

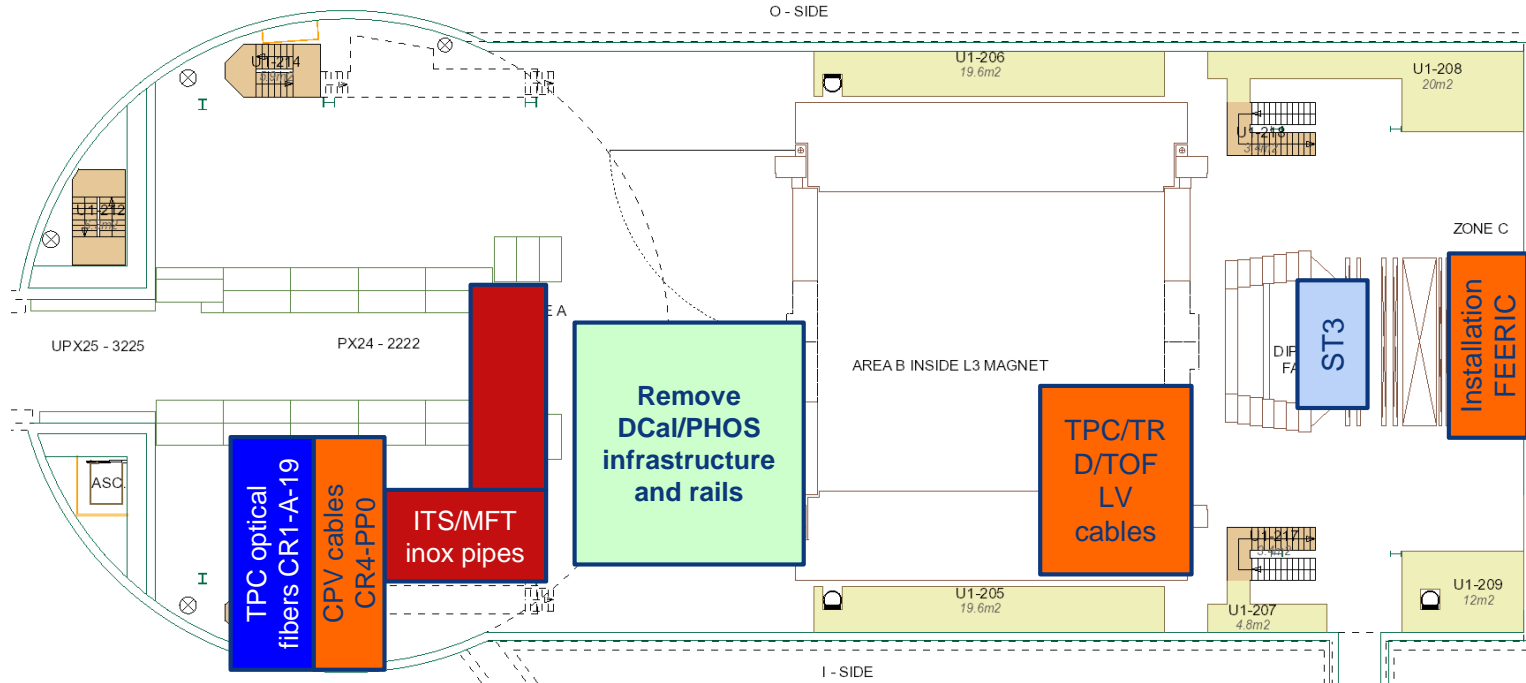

SXL2 activities w13 – Fri 29 Mar 2019

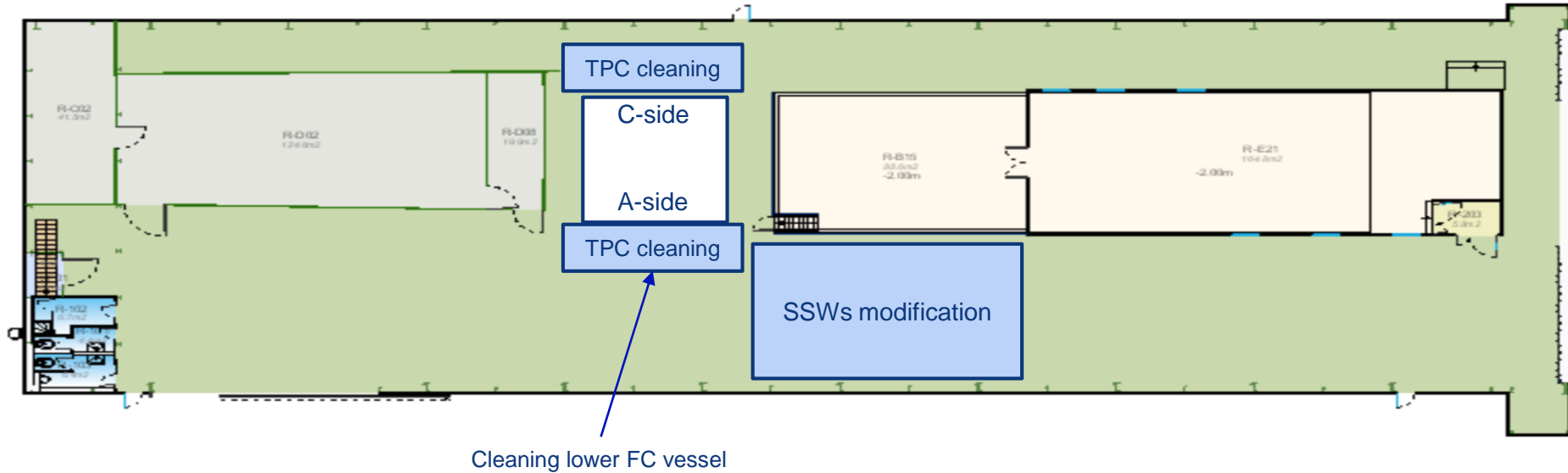

Day-by-day sequence w14

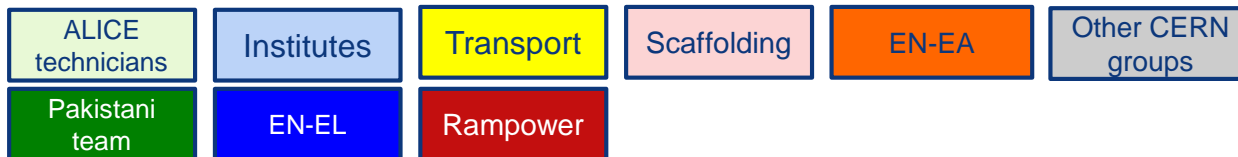

UX25 activities w14 – Mon 1 Apr 2019

Reprogram SNIFFER PLC + battery/HMI screen replacement → no access underground from 17:30 to 20:30

EN-EL: P2 diesel maintenance

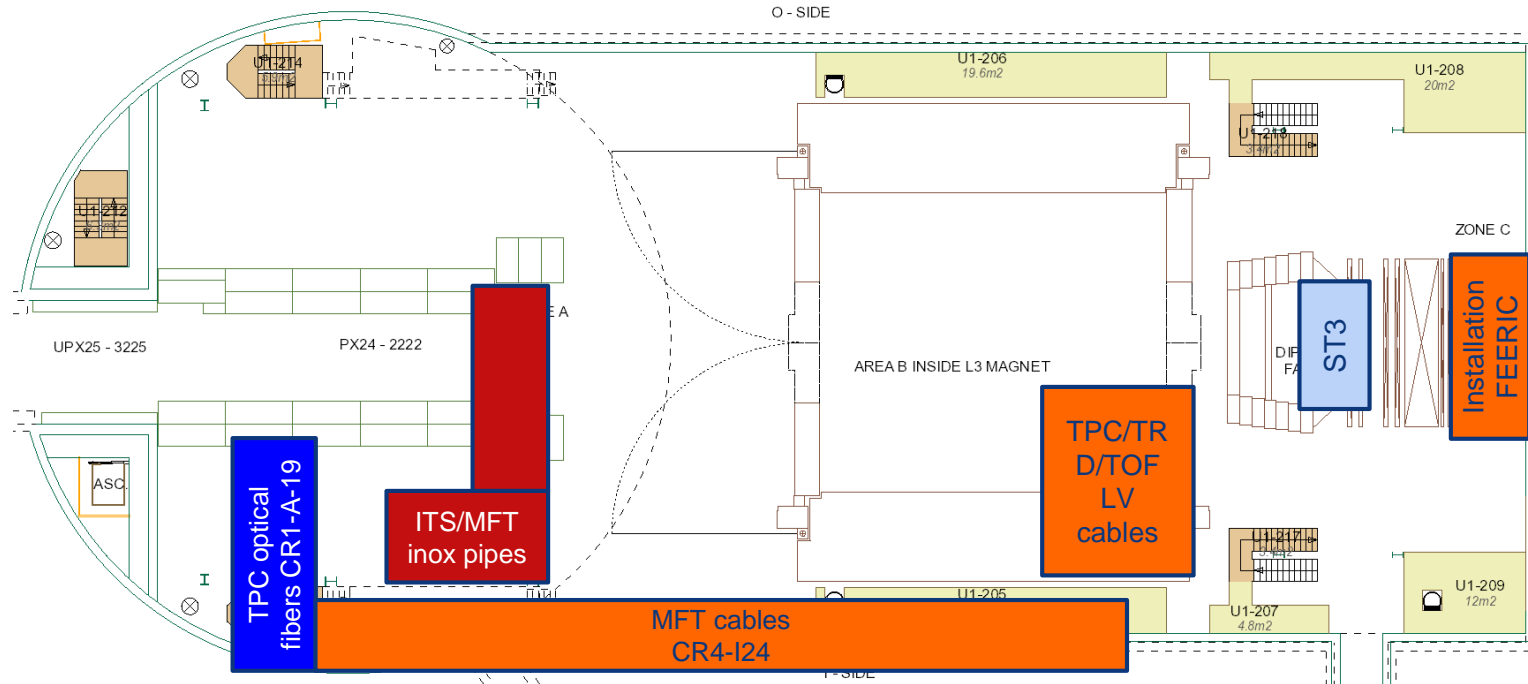

SXL2 activities w14 – Mon 1 Apr 2019

EN-HE: rent special nacelle (whole week)

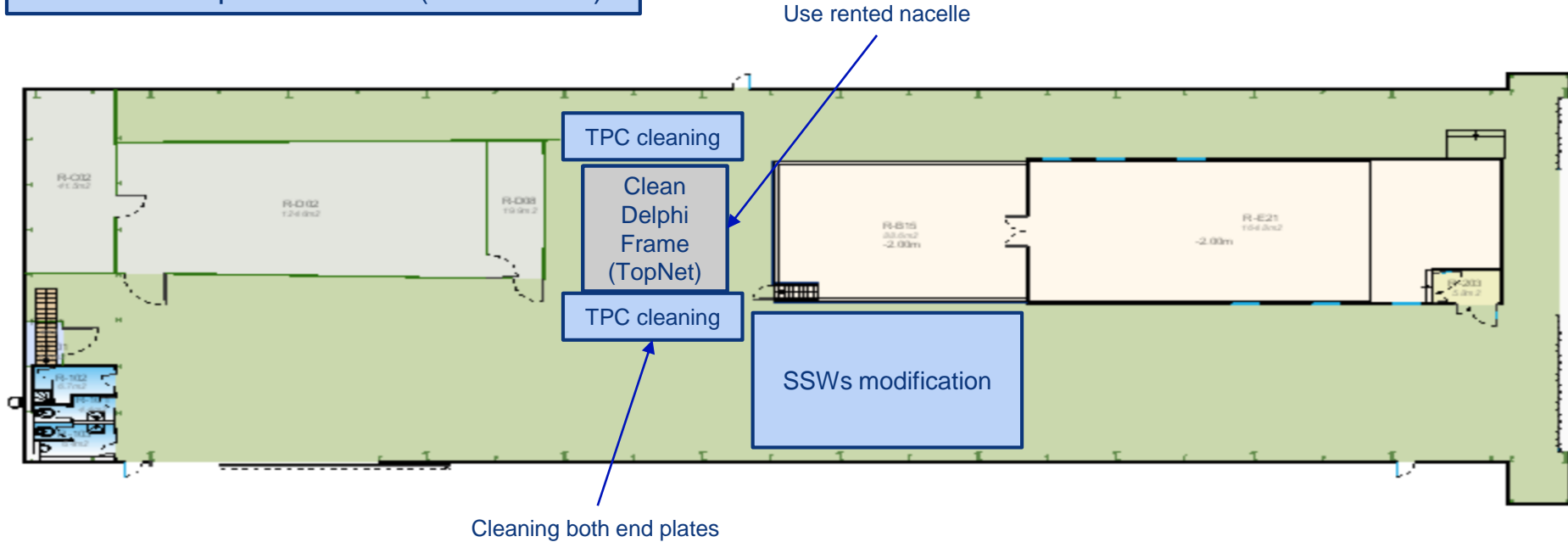

UX25 activities w14 – Tue 2 Apr 2019

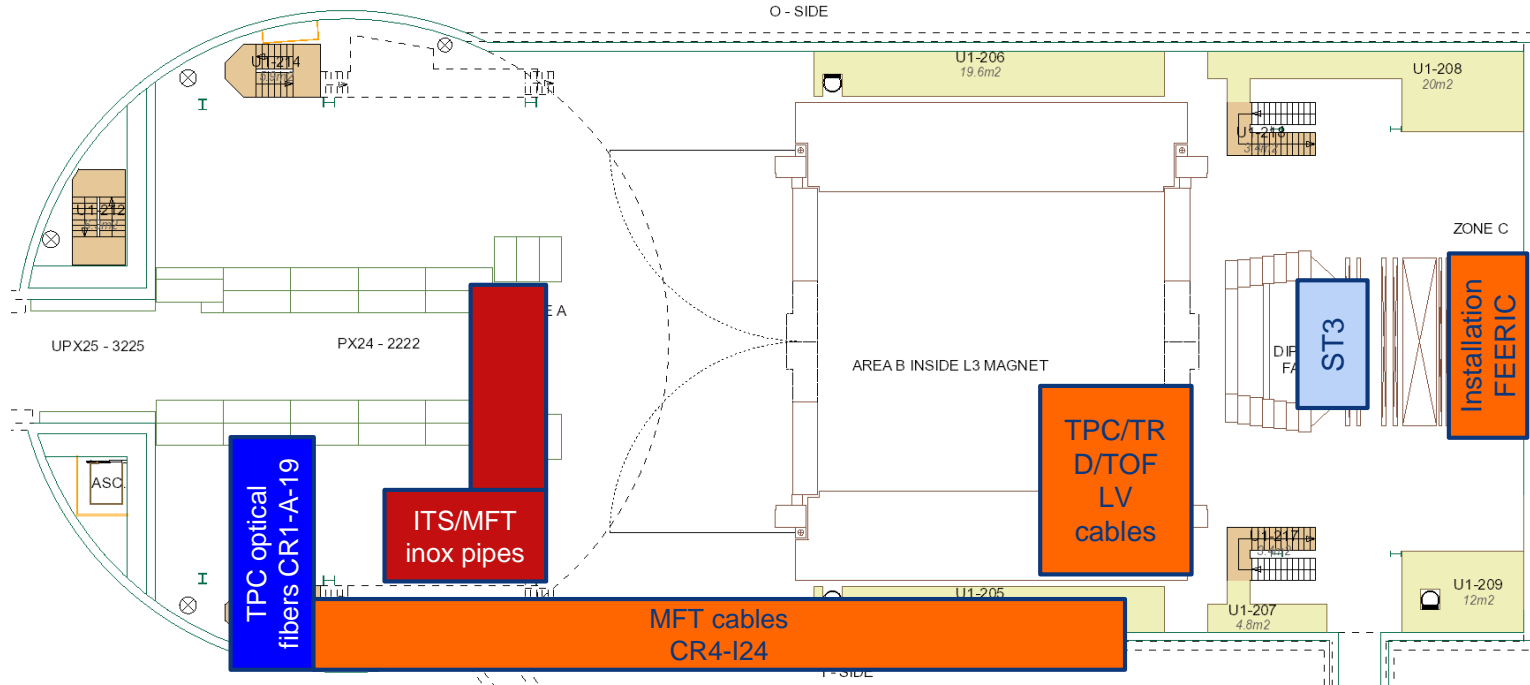

SXL2 activities w14 – Tue 2 Apr 2019

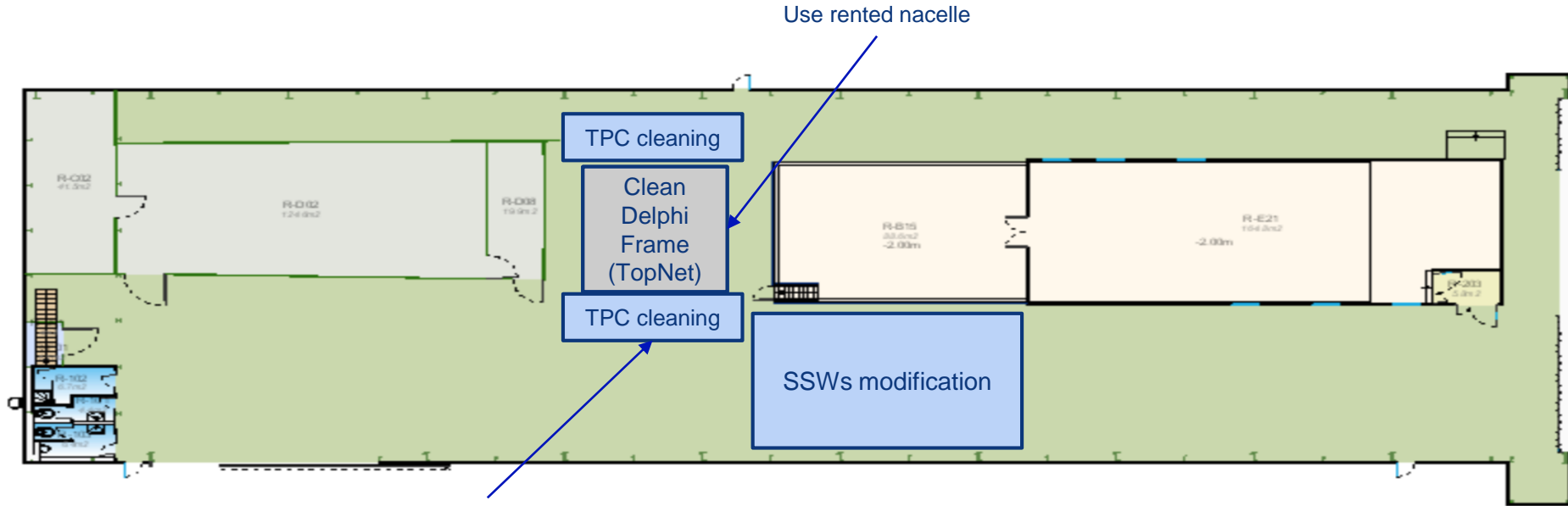

Remove some laser splitter or prism boxes on A and C sides, possibly also some camera boxes

UX25 activities w14 – Wed 3 Apr 2019

Remove miniframe services (pipes, cables) – Pakistani team (whole week)

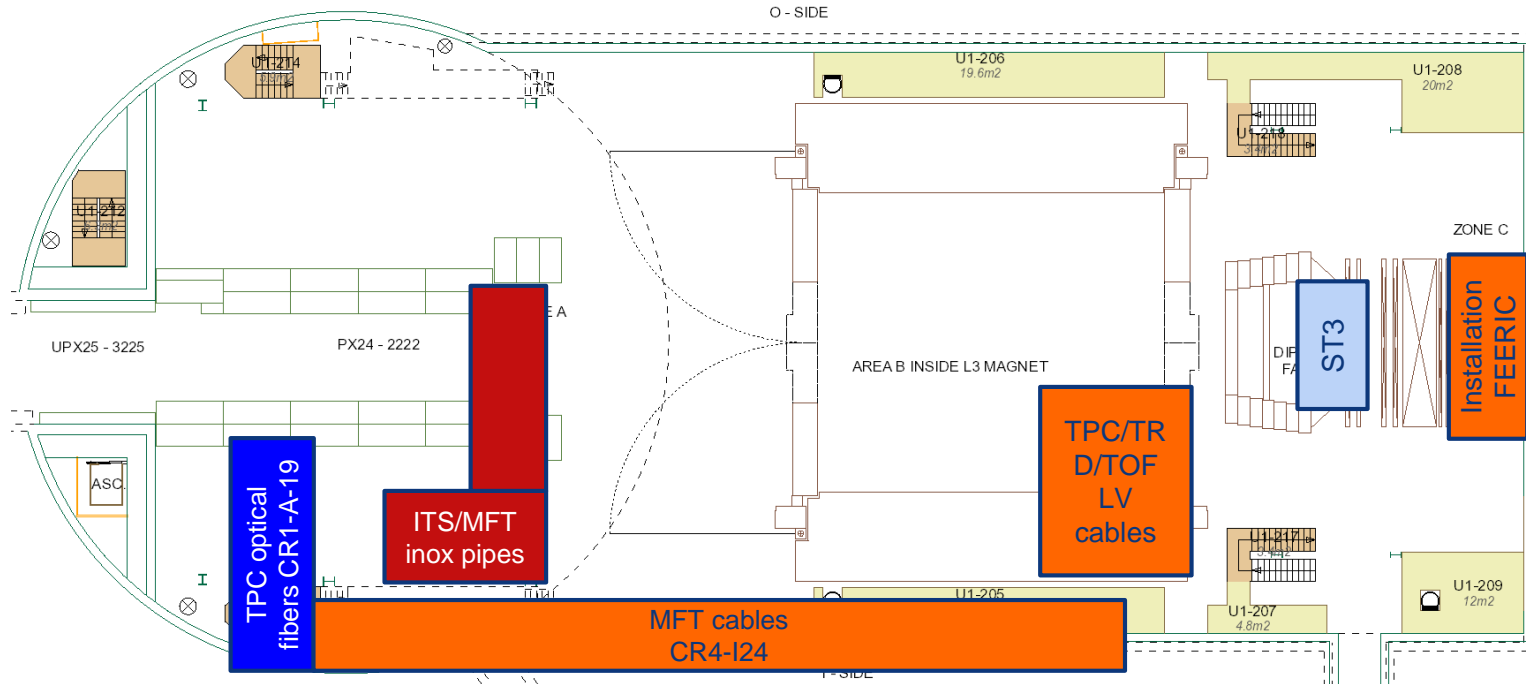

SXL2 activities w14 – Wed 3 Apr 2019

EN-CV: stop clean room ventilation around 16:00 + close air ducts (Piotr)

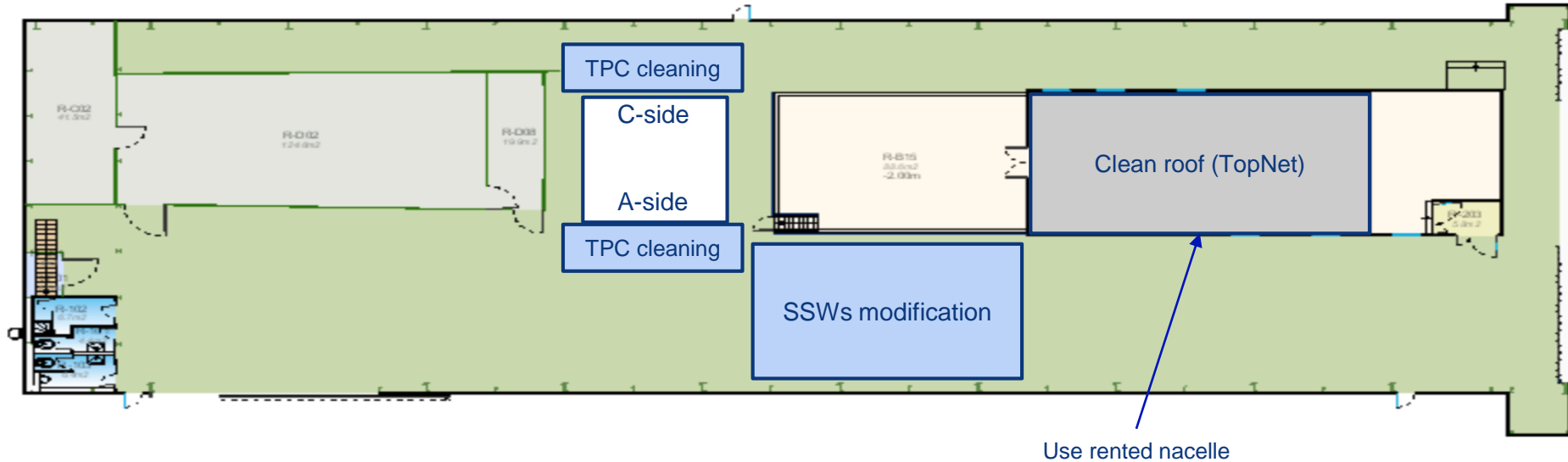

UX25 activities w14 – Thu 4 Apr 2019

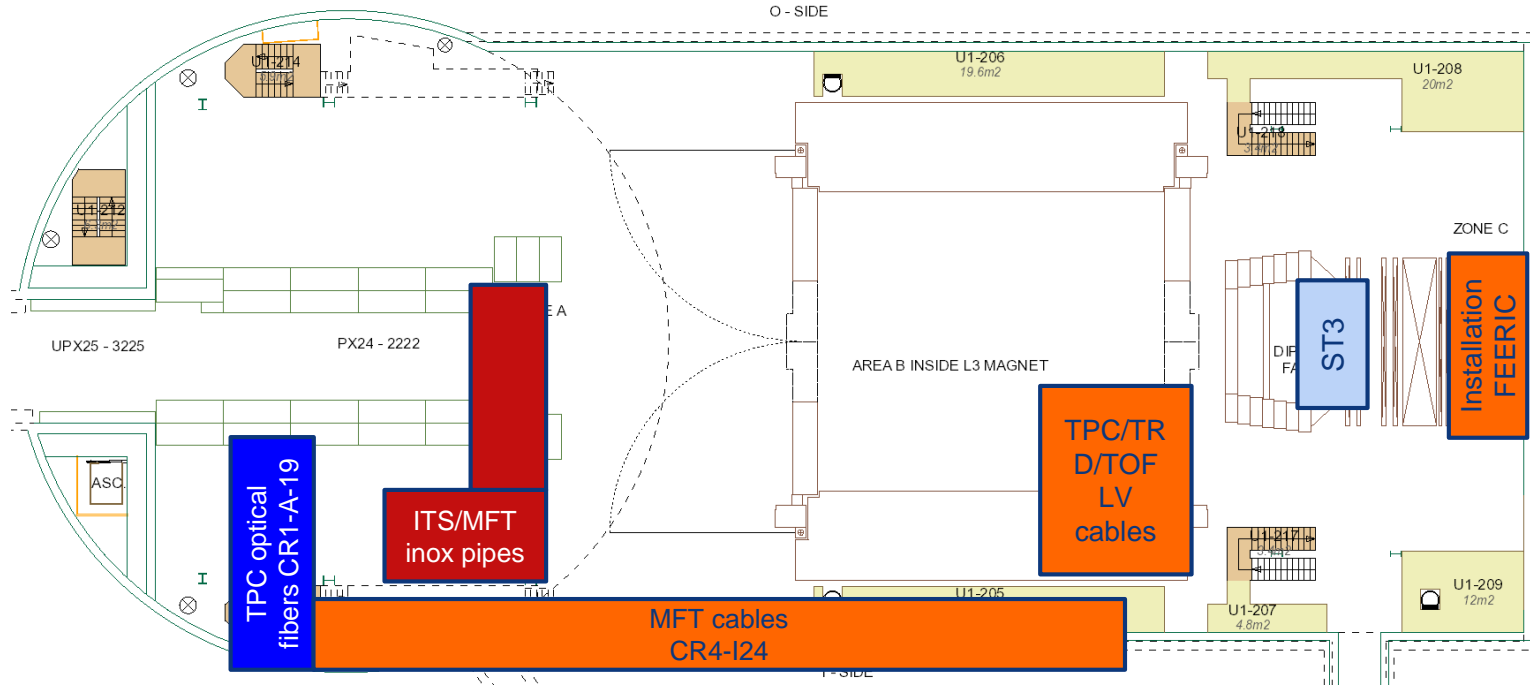

SXL2 activities w14 – Thu 4 Apr 2019

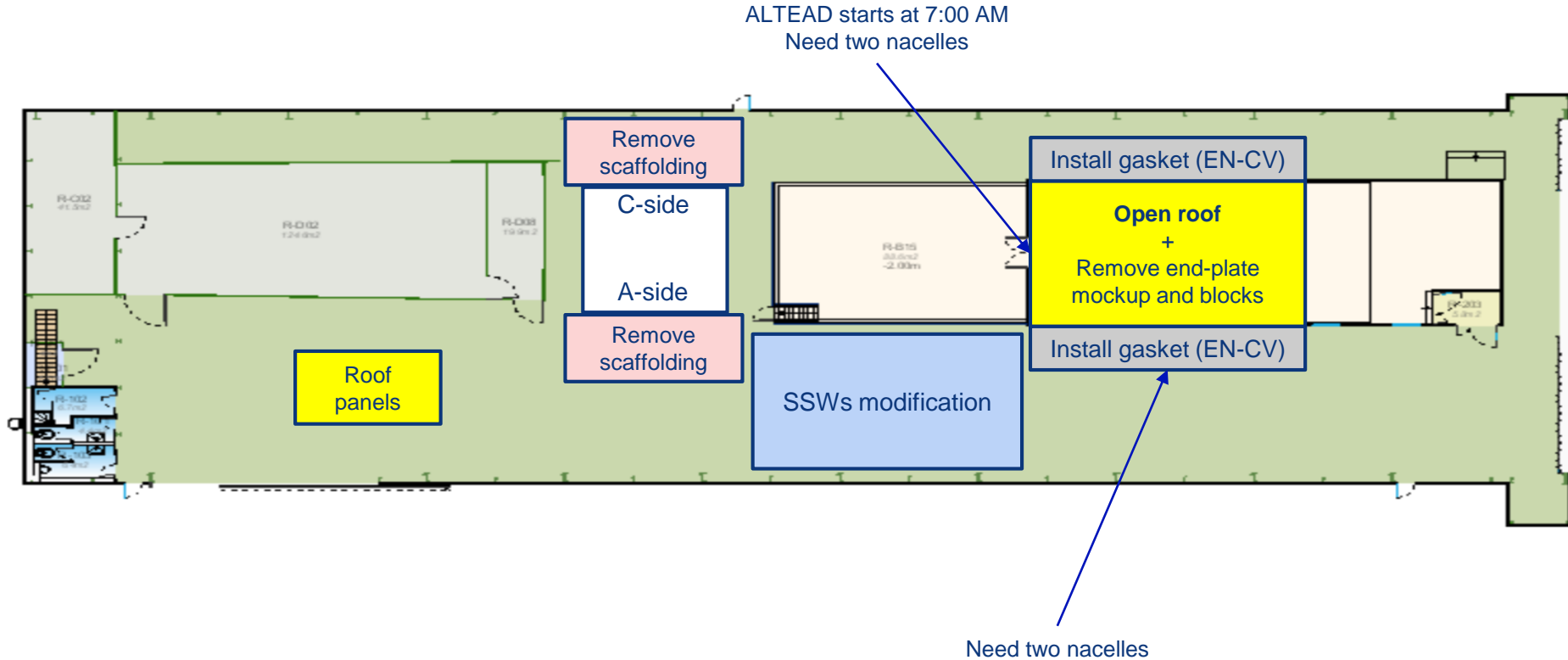

UX25 activities w14 – Fri 5 Apr 2019

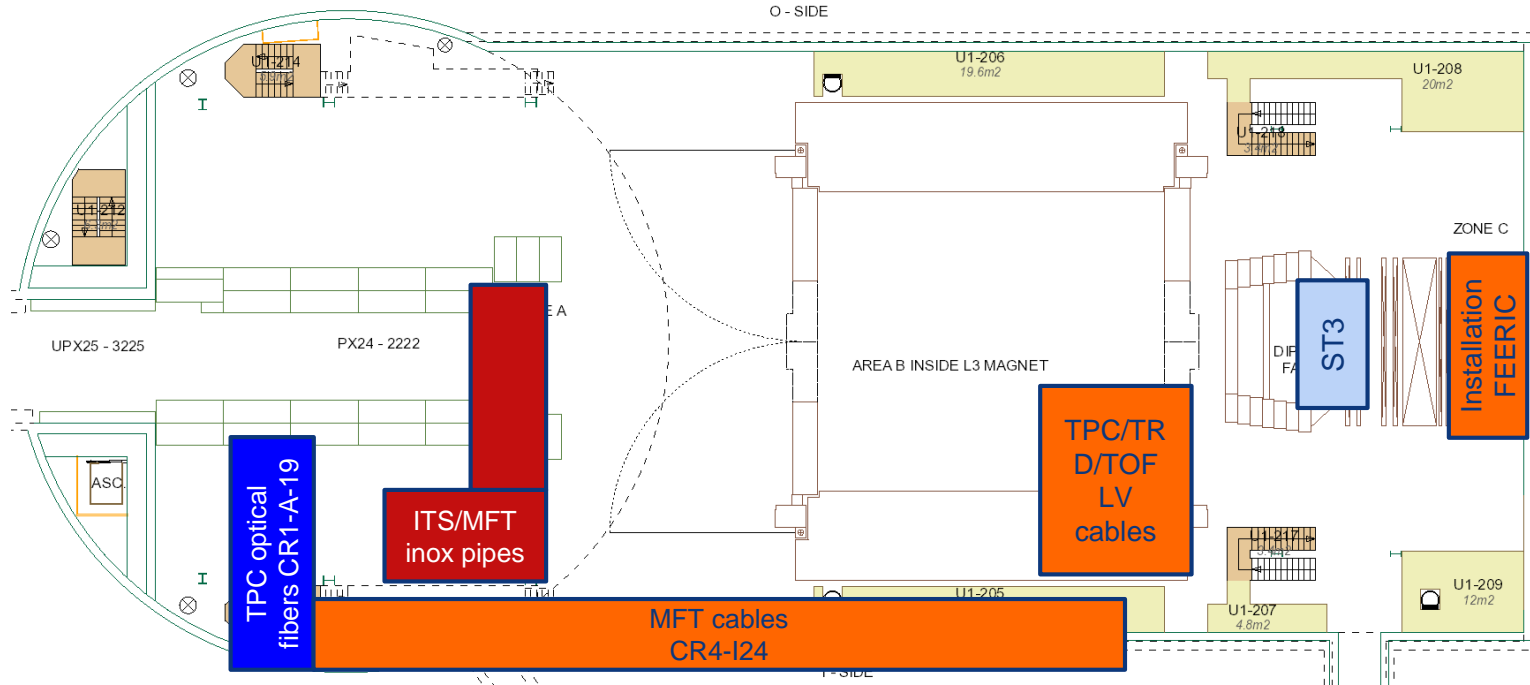

SXL2 activities w14 – Fri 5 Apr 2019

