

LS2 planning meeting

A.Tauro

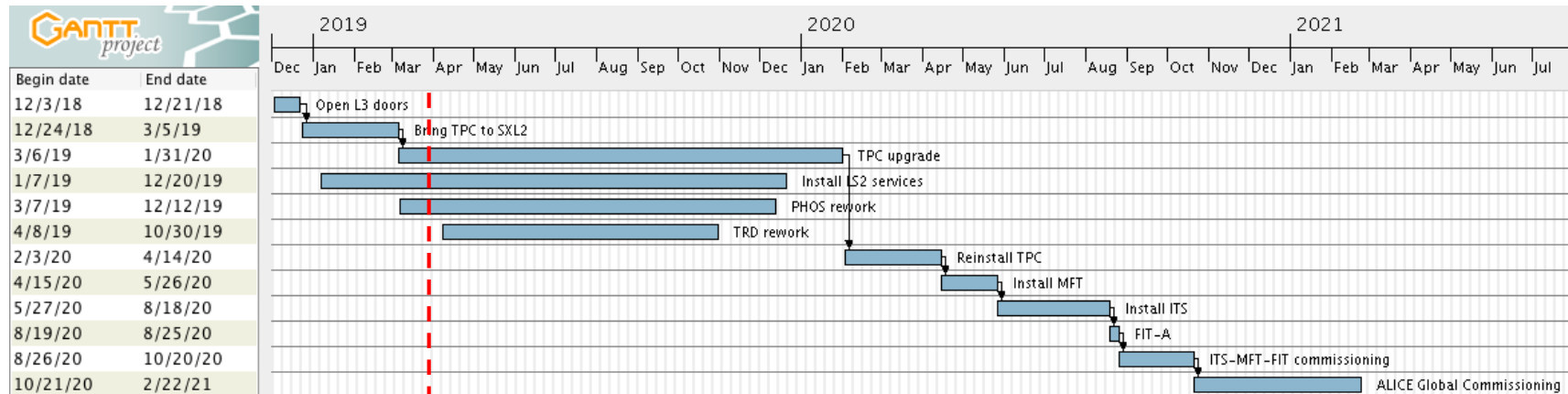

LS2 master plan



EN-EL interventions

- ~~AUG on Monday 25 March 2019 – no access on site (both surface and underground)~~
- Diesel maintenance: 1 Apr 2019
- CERN wide 66kV maintenance: 28 May 2019 to 19 July 2019 – reduced consumption (i.e. no magnets)
- Test secours (10 min): 19 Dec 2019 from 8:00 AM to 11:00 AM
- 18kV, 3.3kV and LV network maintenance:
 - Mon 20 to Wed 22 Jan 2020: 3 days no general services - no access on site (both surface and underground)
 - Thu 23 to Fri 24 Jan 2020: 2 days “Limited access” → details being worked out
- AUG on Monday 27 January 2020 - no access on site (both surface and underground)
- Auto transfer test: 27-29 Apr 2020
- BIW test: 5 and 6 Oct 2020 from 18:00 to 00:00 – no access underground

Diesel maintenance next week

- Diesel test next week is transparent for us.
- The whole intervention will take 2 days (Mon/Tue), but the diesel will not be available for ~3hrs (on Monday afternoon). However we are still covered by the Pays de Gex 20kV in case of power cut. In addition EL will be on site and will be able to reconfigure the network in such case, or even start the diesel (depending on where they are in the maintenance).

EN-CV interventions

- **Big maintenance:**
 - SF: from Nov 2019 to mid Jan 2020. NO impact on ALICE as both magnets will be OFF.
 - UW: **stop UX mixed water** for 2 days in week 40/2019 (October).
 - SU: various small perturbations + 1 day **stop all cooling UX** + 1 day **stop all cooling SXL2** in week 16/2020 (April).
- **Small maintenance:**
 - UW: from mid Aug 2020 to mid Sep 2020. **Stop mixed water UX** for 1 day in week 37/2020 (September).
 - SF+SU: weeks 45-47/2020: cleaning towers (stop SF 1 week) + 1 day **stop all cooling UX**.
- **Ventilation:**
 - SG2: w7/2019 - Done
 - Gas extraction: w8/2019 - Done
 - UX25 cavern: May 2020 (tbc)
 - MCH and MTG: Apr 2020 (tbc)
 - L3: Apr 2020 (tbc)
 - ITS: Apr 2020 (tbc)
- **Raw water:**
 - Test after Apr 2019. Short interruption (1 day), can be used tap water during the test.

CERN Open Days

- 14 and 15 September 2019

DCal/PHOS/CPV schedule

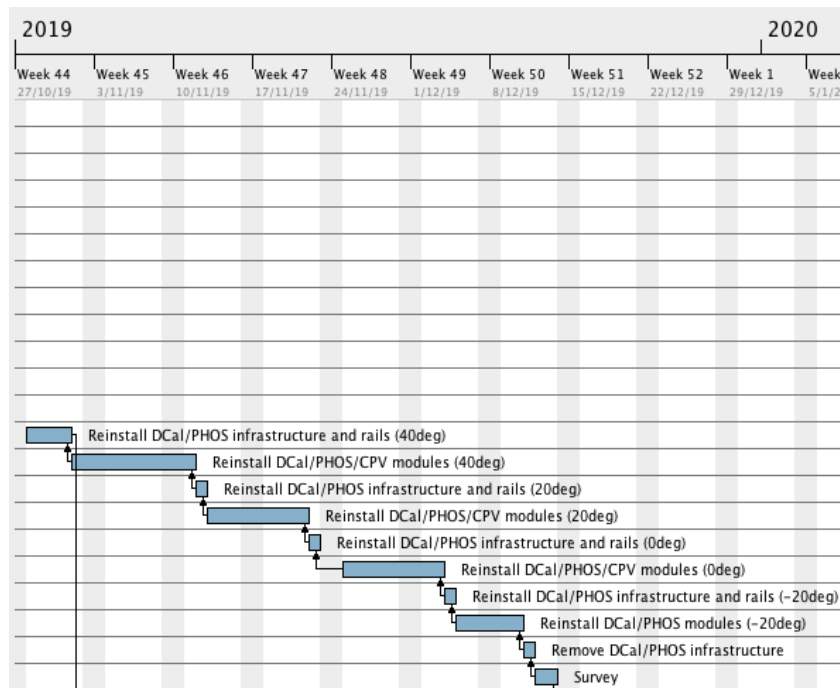
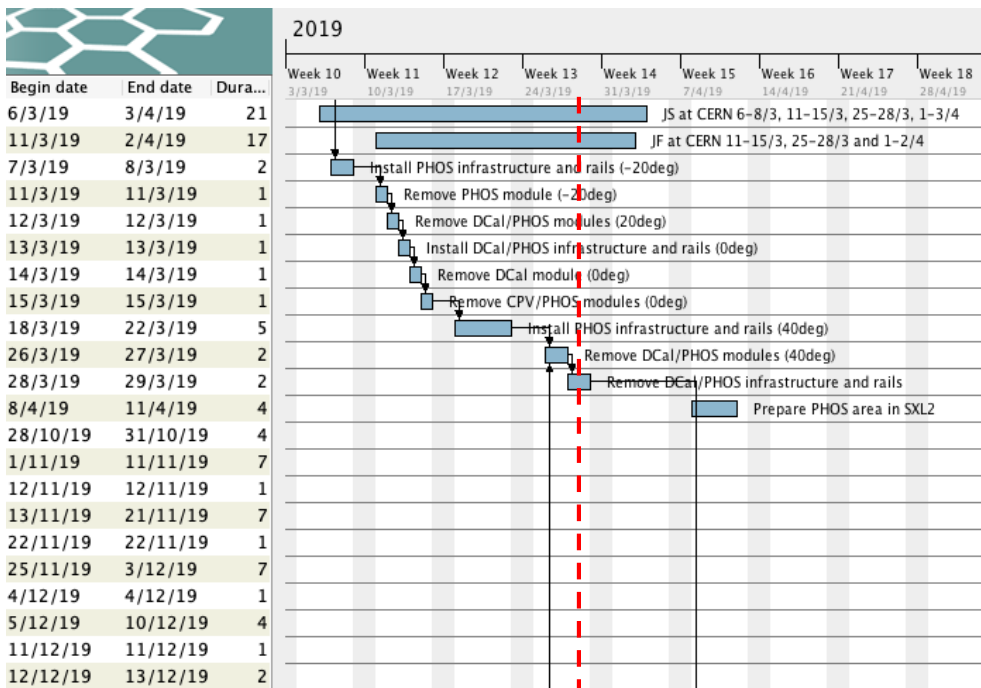

Repair PHOS #4 in SXL2 from mid April

TRD schedule

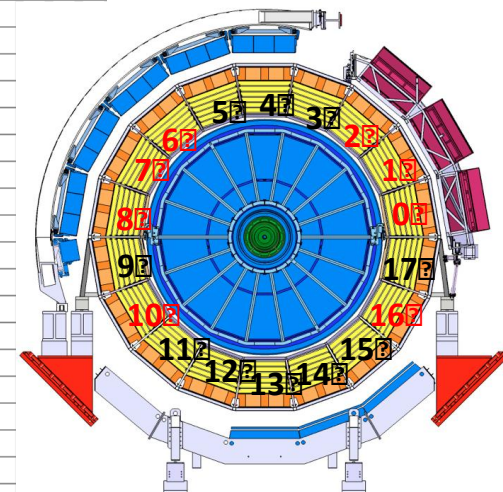
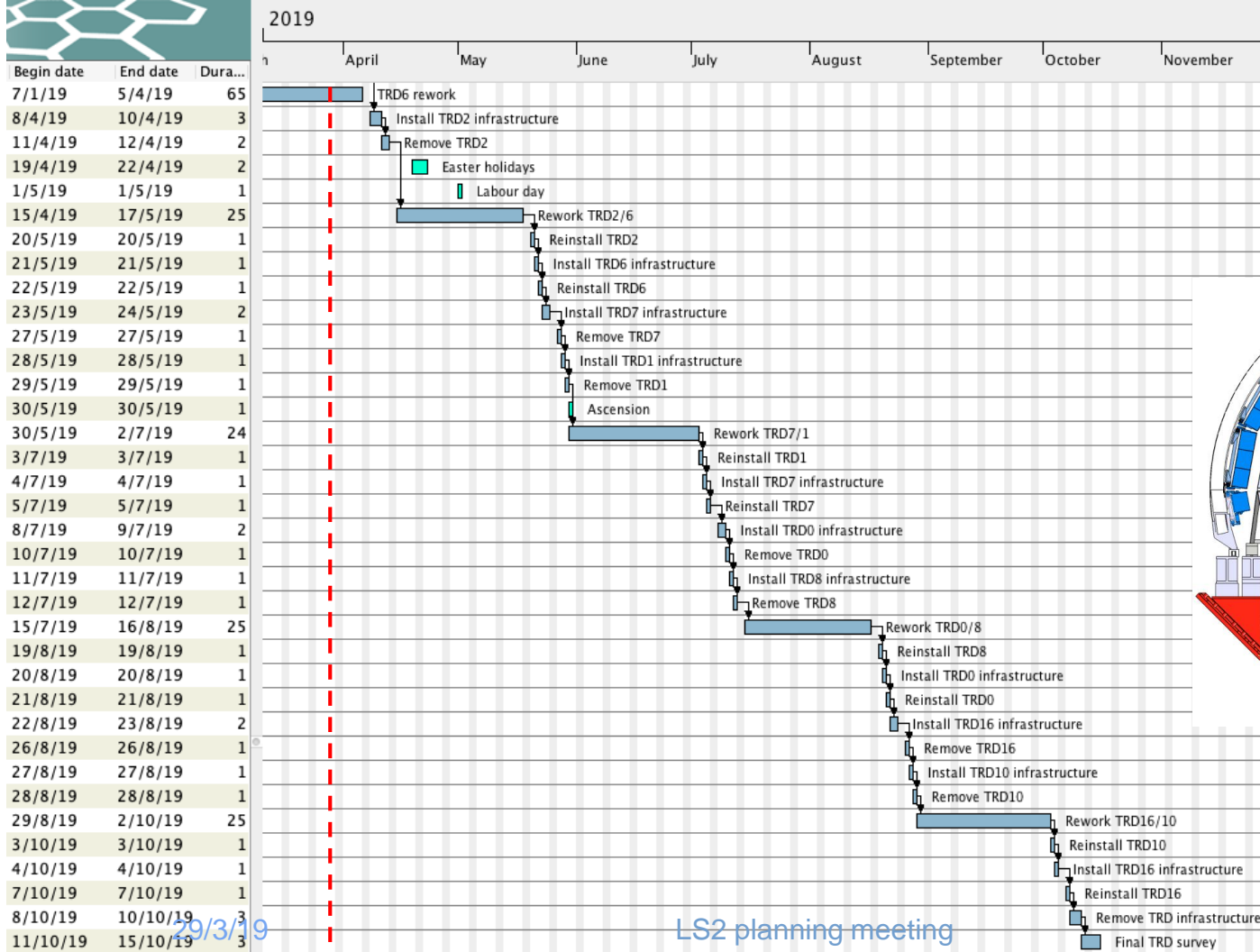

TPC upgrade sequence

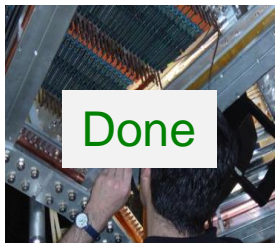

**Remove FEE
outside cleanroom**

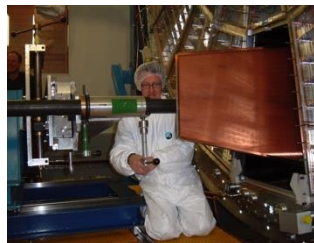

Remove ROC



**Survey, sealing,
OVP test**

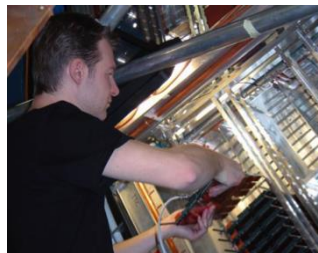

**Install new FEC +
test**



**TPC ready for
transportation**



**TPC in cleanroom
Irradiation tests**



Install new ROC



Irradiation tests

7 Mar '19

5 Apr

25 Apr (A)
27 Jun (C)

13 May (A)
10 Jul (C)

28 May – 17 Jun (A)
23 Jul – 8 Aug (C)

11 Sep (A)
26 Sep (C)

19 Dec

4 Feb '20

TPC schedule – Mar-Apr

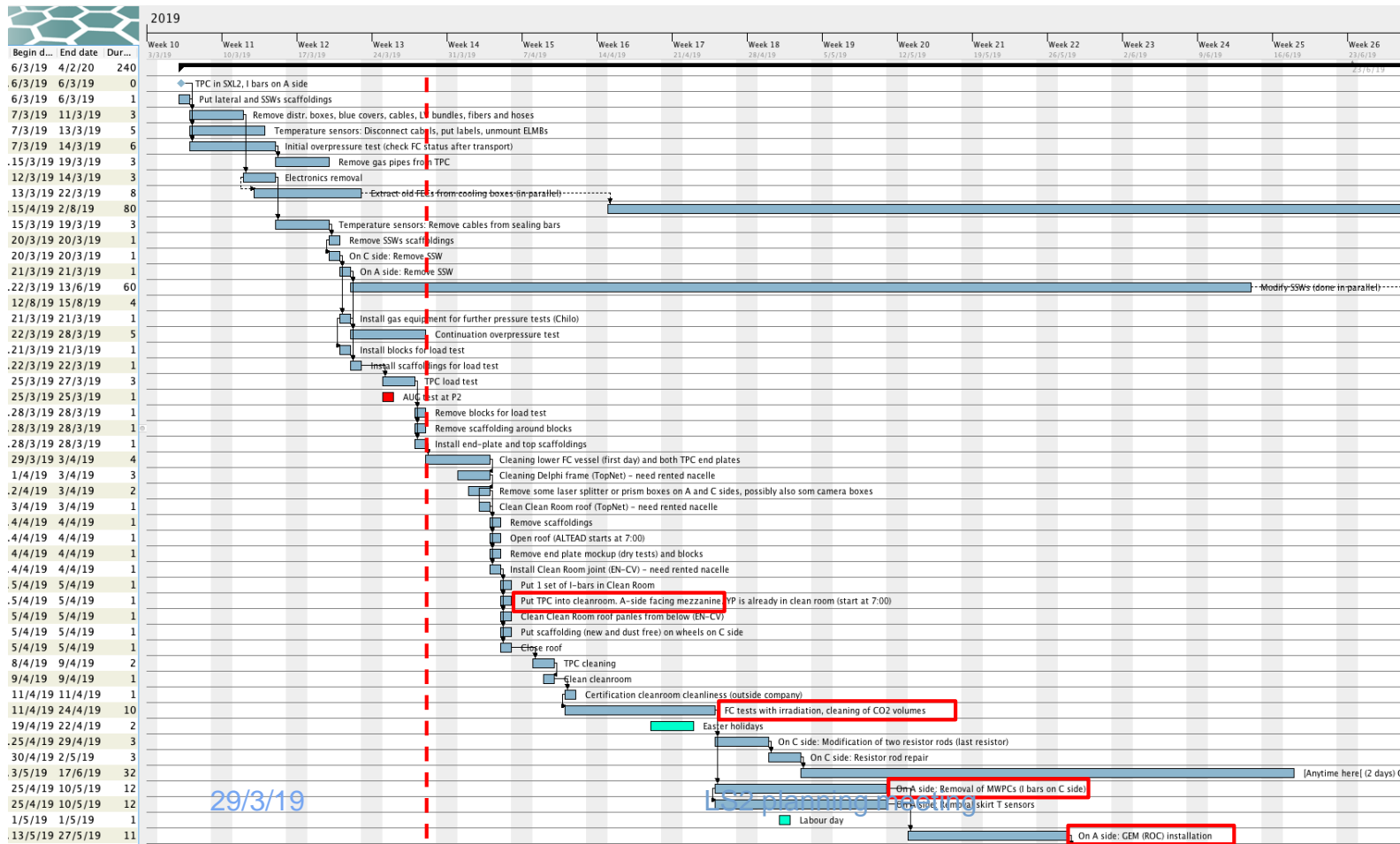

29/3/19

Copper cables (EN-EA)



Begin date	End date	Dura...
11/3/19	14/3/19	4
15/3/19	26/3/19	8
27/3/19	29/3/19	3
1/4/19	5/4/19	5
8/4/19	12/4/19	5
15/4/19	19/4/19	5
22/4/19	26/4/19	5
29/4/19	14/5/19	12
15/5/19	24/5/19	8
27/5/19	31/5/19	5
3/6/19	7/6/19	5
10/6/19	14/6/19	5
17/6/19	20/6/19	4
21/6/19	21/6/19	1
24/6/19	28/6/19	5
1/7/19	5/7/19	5
8/7/19	17/7/19	8
18/7/19	19/7/19	2
22/7/19	23/7/19	2
18/3/19	19/7/19	90

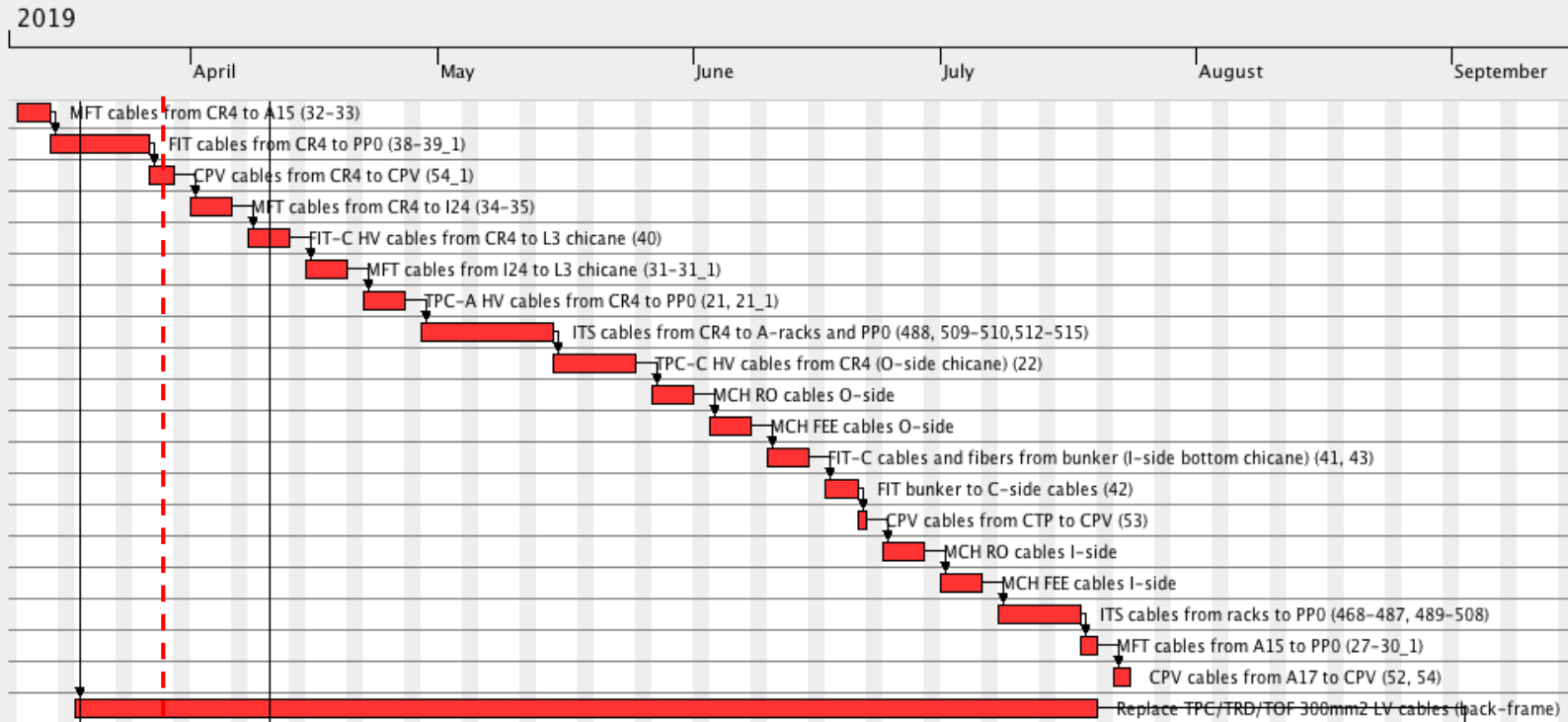

Copper cables – dates completion connectors + test (EN-EA)

Cavern:

- TPC : 29/10/2019
- ITS : 19/11/2019
- MFT : 27/11/2019
- FIT : 3/12/2019
- CPV : 21/10/2019
- MCH : 10/07/2019

This is a proposal, please check these dates

Miniframe:

- TPC : 03/02/2020
- ITS : 04/03/2020
- MFT : 11/03/2020
- FIT : 03/03/2020

Optical fibers (EN-EL)

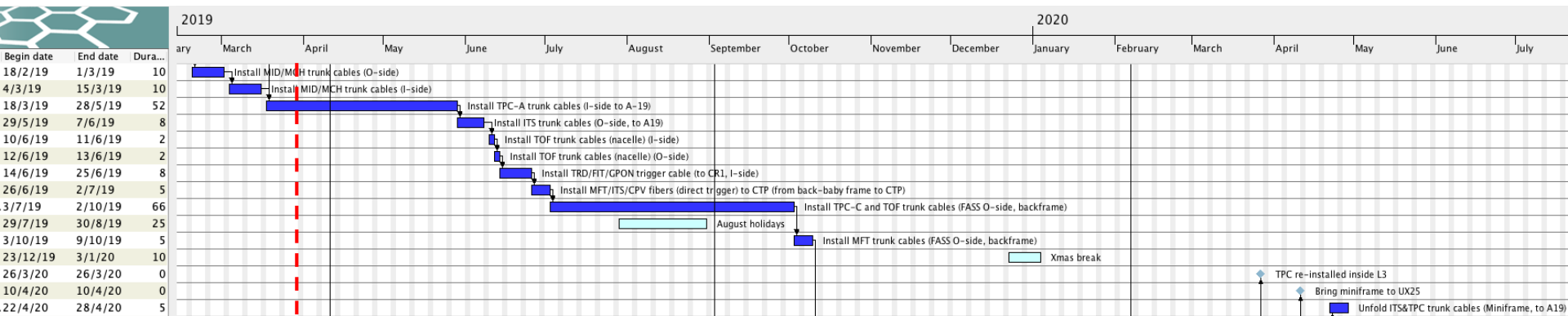

Day-by-day sequence w13



UX25 activities w13 – Mon 25 Mar 2019

TRD platform modification (Didier, Philippe - SX2)

Jean-Se and Jean-Francois at CERN: 25-28/3

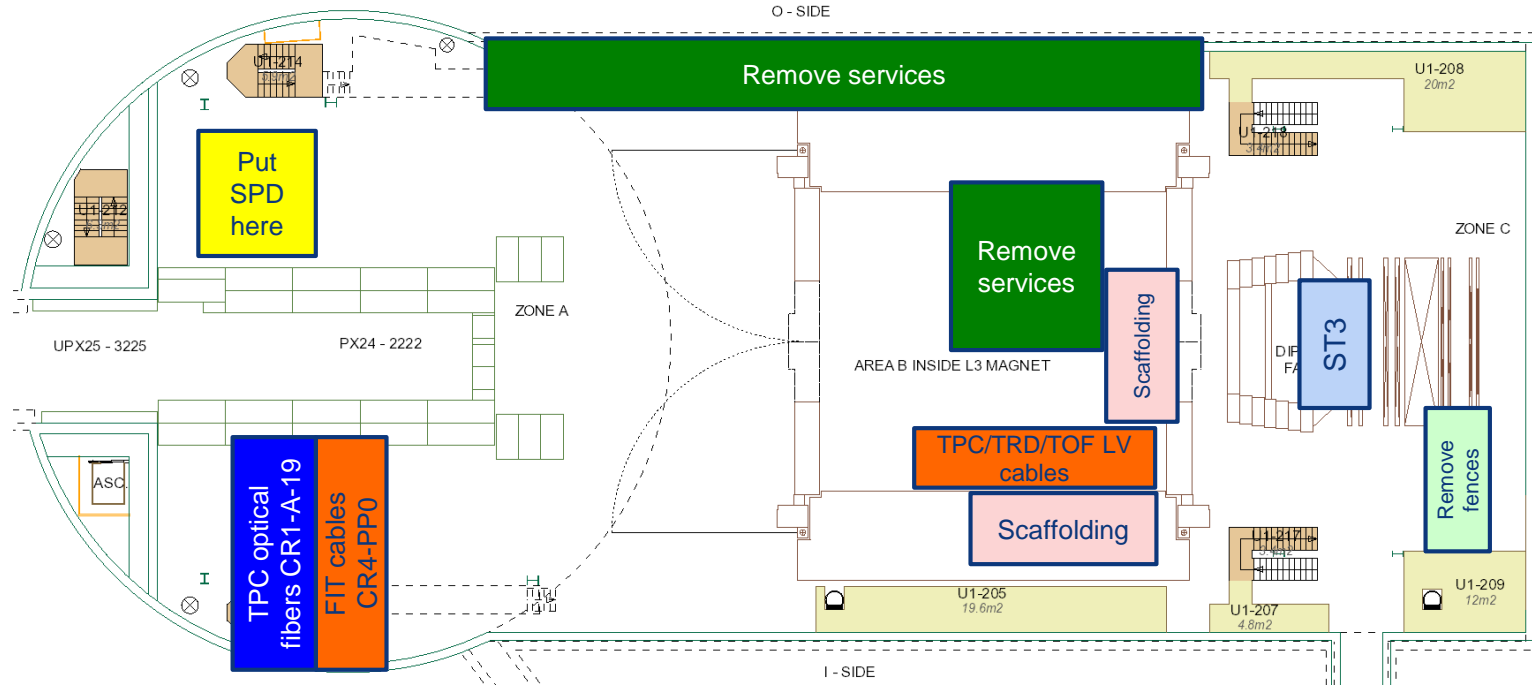

SXL2 activities w13 – Mon 25 Mar 2019

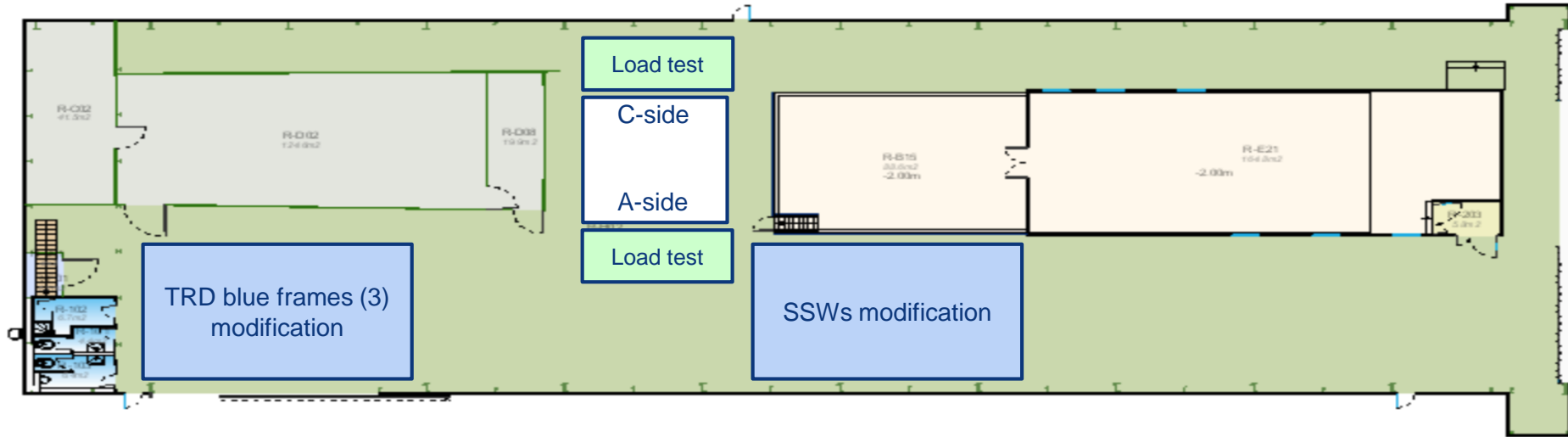

UX25 activities w13 – Tue 26 Mar 2019

HSE revalidation PPEs in 3294 R-002

ALTEAD: move TRD table outside SX2

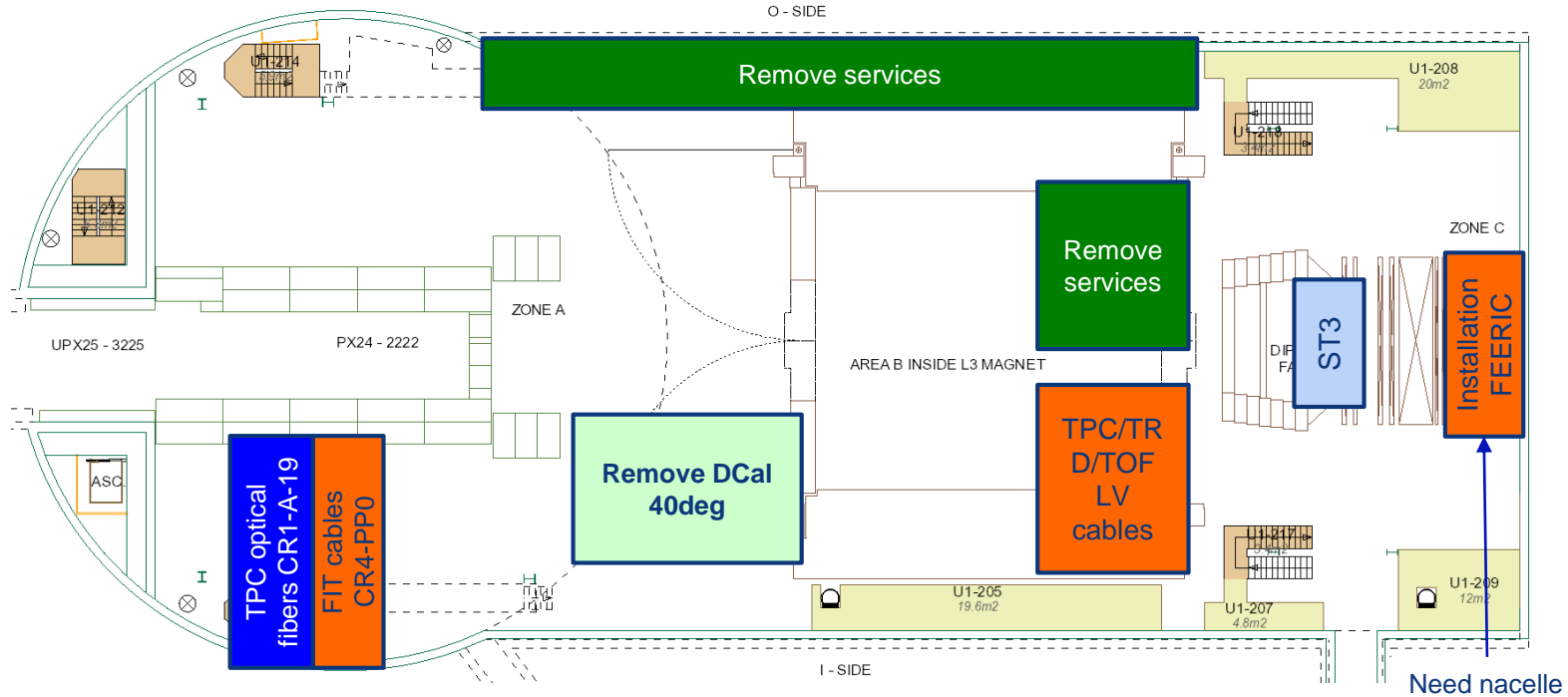

SXL2 activities w13 – Tue 26 Mar 2019

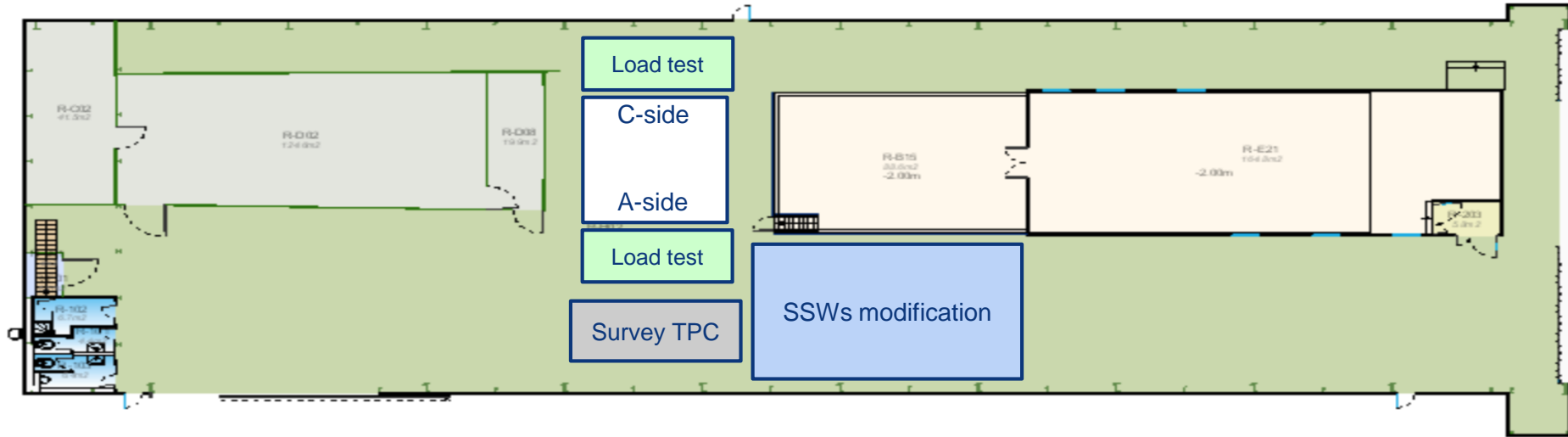

UX25 activities w13 – Wed 27 Mar 2019

ALTEAD: transport TRD blocks inside SX2 (30)

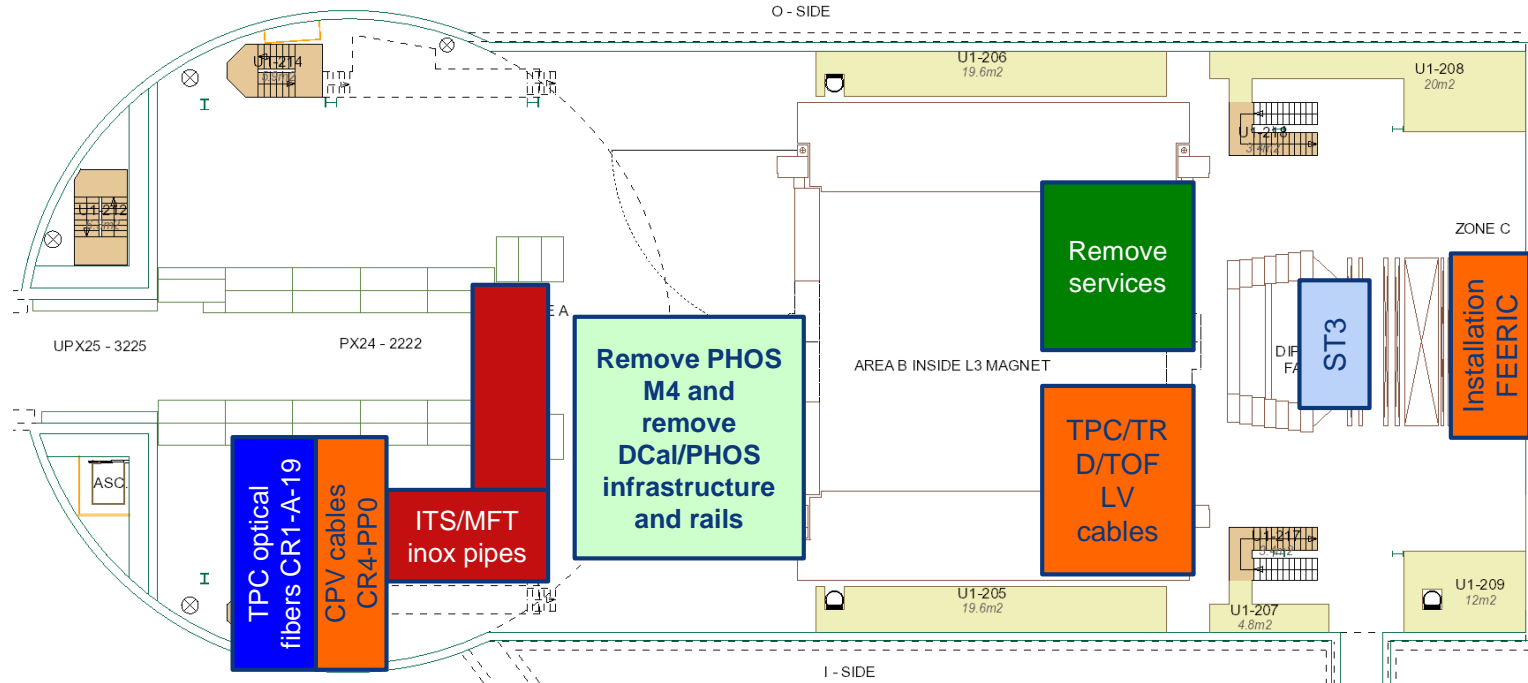

SXL2 activities w13 – Wed 27 Mar 2019

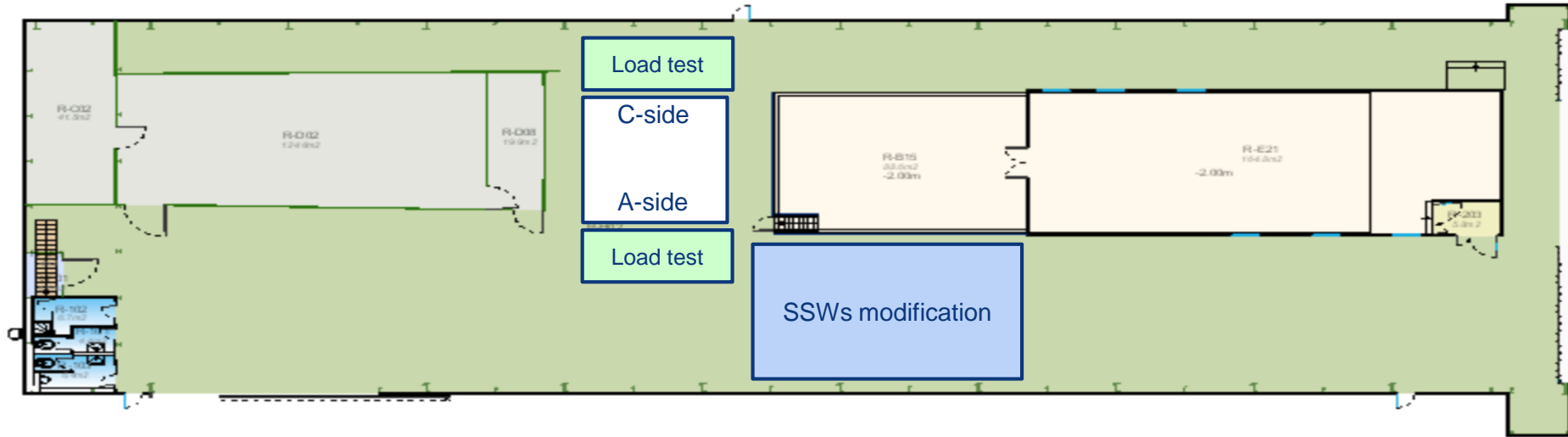

UX25 activities w13 – Thu 28 Mar 2019

Remove miniframe services (pipes, cables) – Pakistani team (whole week)

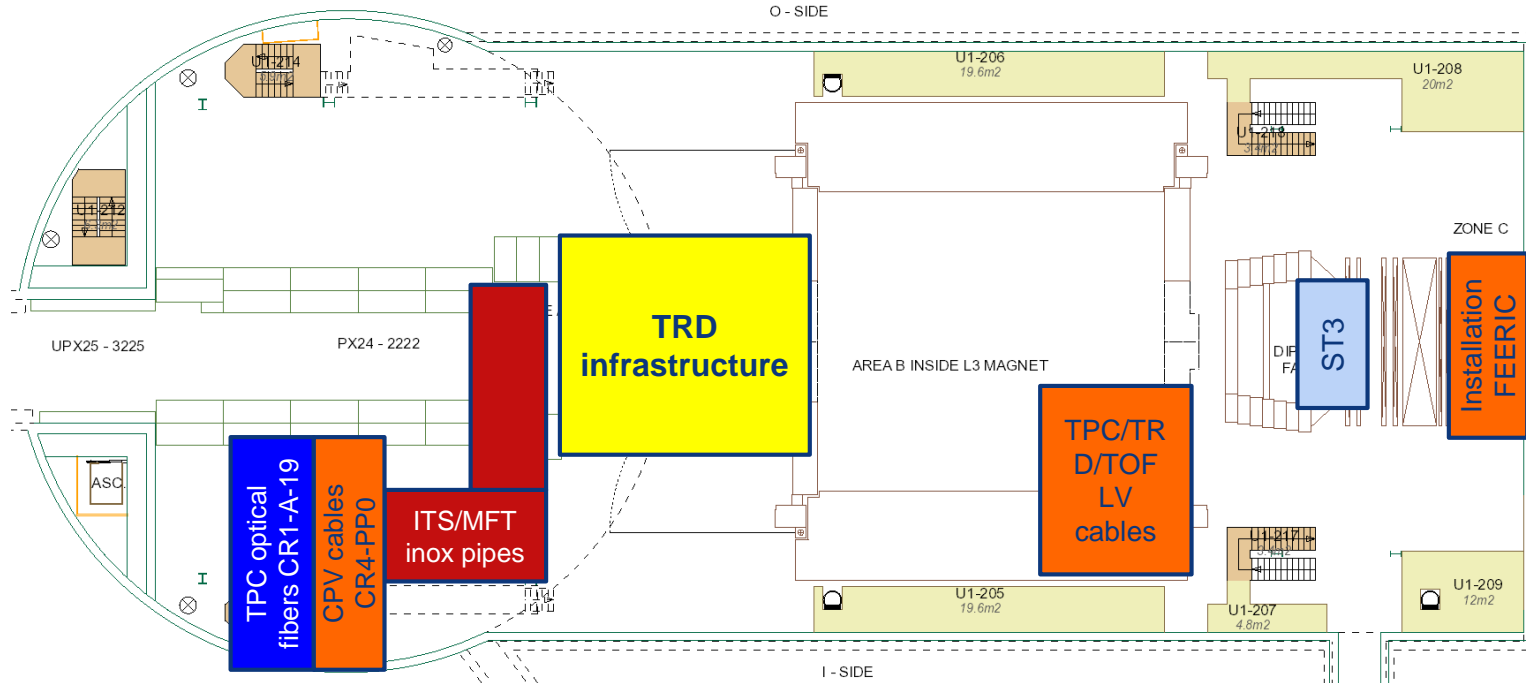

SXL2 activities w13 – Thu 28 Mar 2019

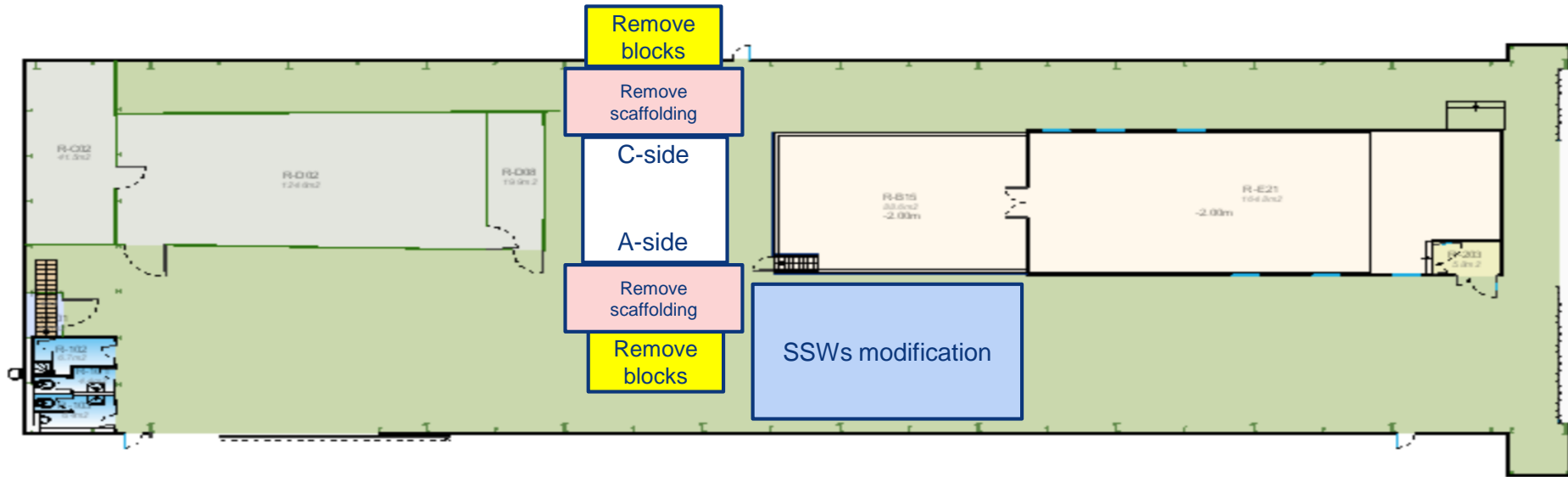

Status w13

- Cavern:
 - DCal 40deg and PHOS M4 extracted. Infrastructure removed
 - Installation TRD blocks started
 - MID FEERIC installation started on Tuesday
 - Services:
 - Copper cables: FIT CR4 to PP0 installed. Next week MFT and FIT cables CR4-C-side
 - Replacement TRD/TPC/TOF LV cables started on Monday. 2 TRD channels tested ok
 - Installation ITS and MFT inox pipes ongoing (Rampower)
 - Installation TPC optical fibers CR1-A19 ongoing (Comsa)
- TPC:
 - Load test performed on Tuesday. Blocks and scaffolding removed.

Highlights w13



Highlights w13



Highlights w13

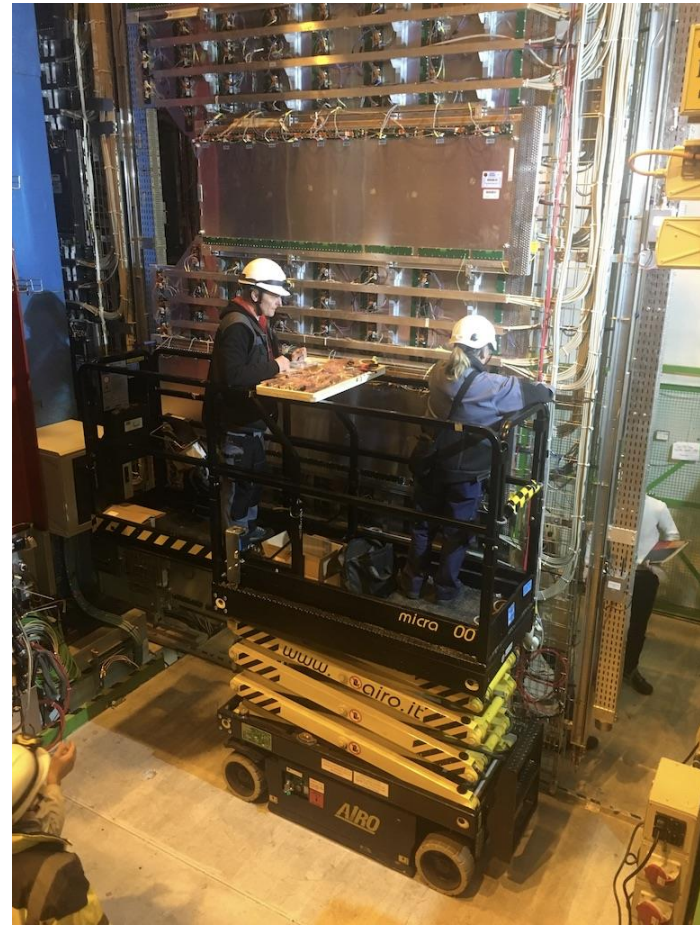

TPC inner bore Load Test

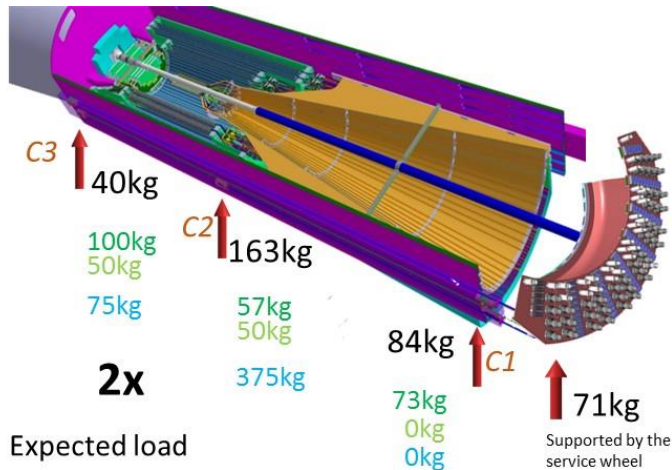

ITS Upgrade
→ Present estimate

Present ITS
→ During Installation
→ During Operation
→ During test

Result

Total Deformation

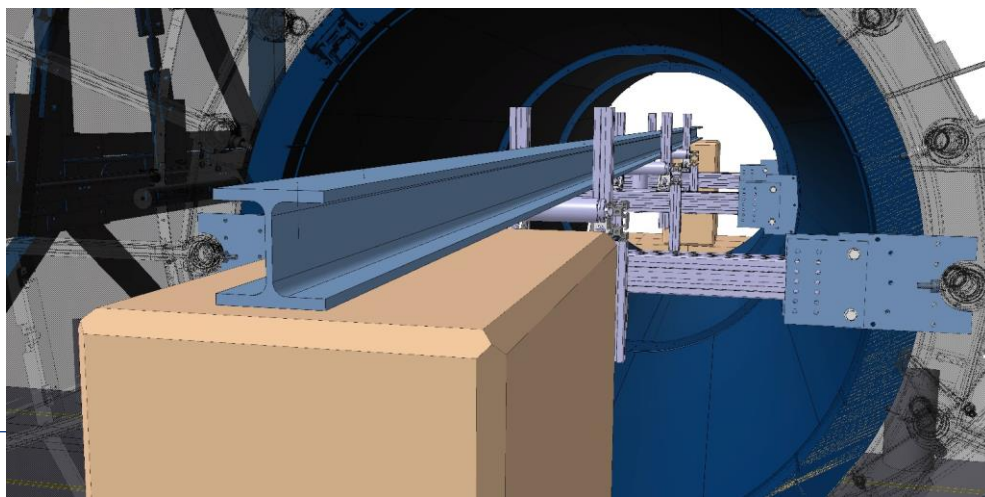
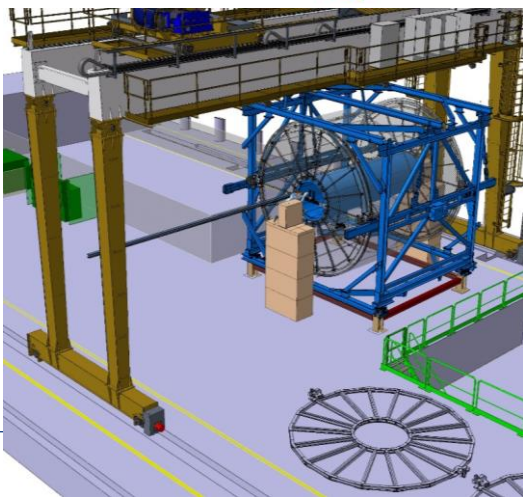
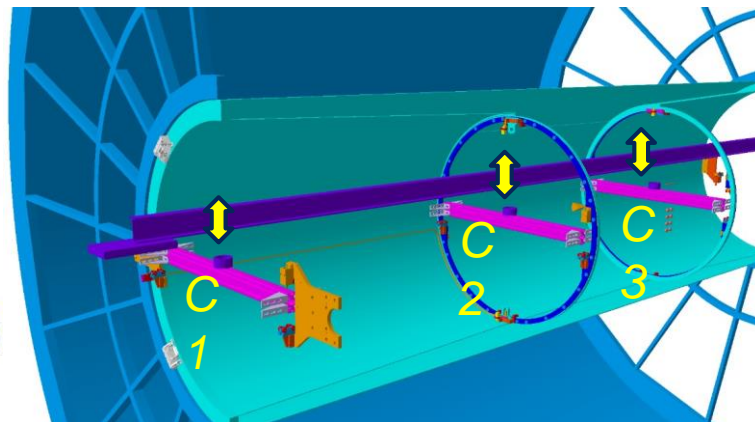
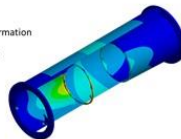
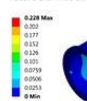

TPC inner bore Load Test

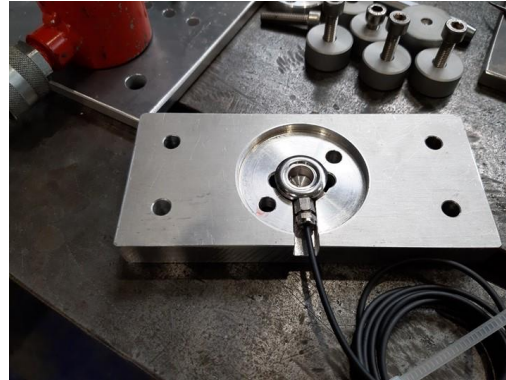
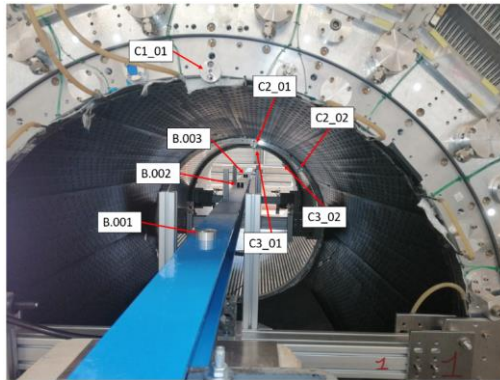
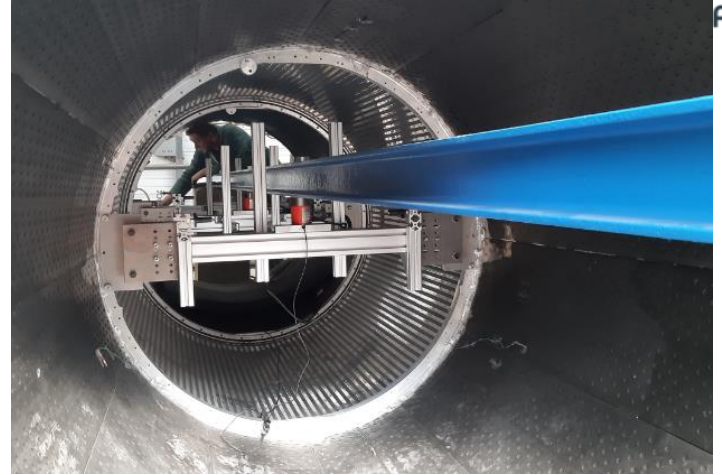

UX25 activities w13 – Fri 29 Mar 2019

Installation 4m3 bin for copper cable, empty 10m3 bin – use it for LV cables

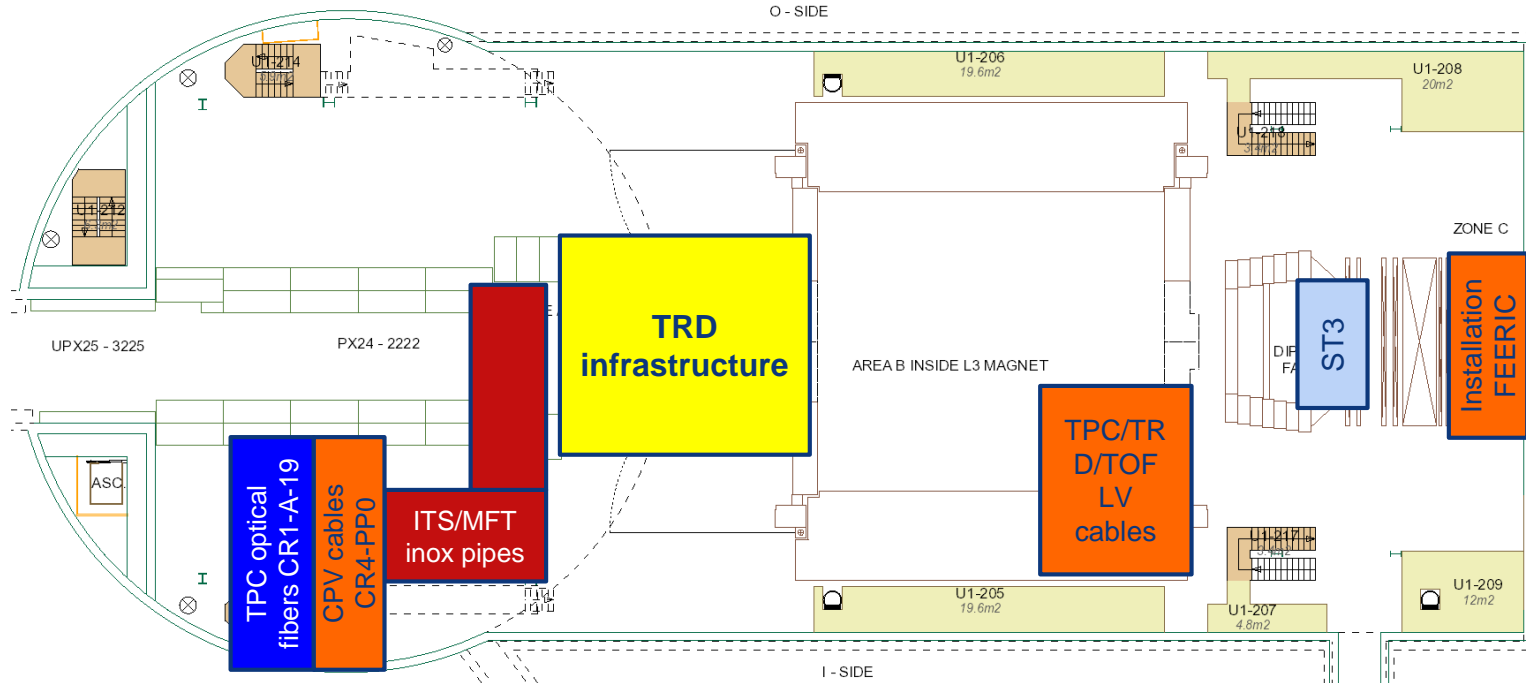

SXL2 activities w13 – Fri 29 Mar 2019

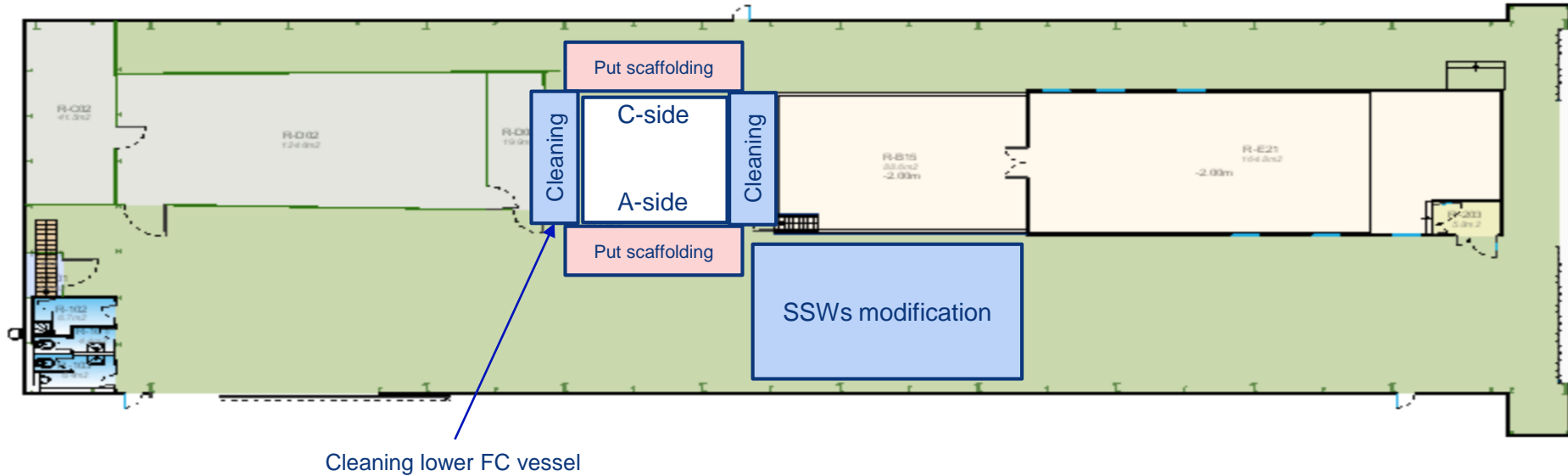

Day-by-day sequence w14

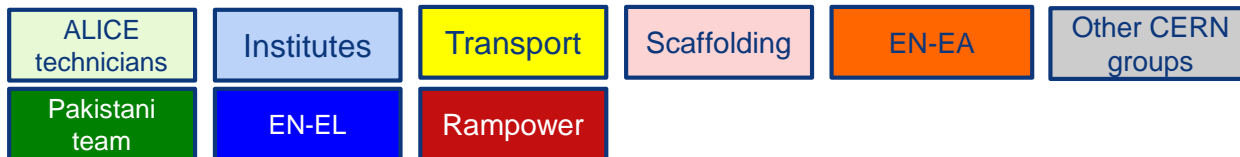

UX25 activities w14 – Mon 1 Apr 2019

Remove miniframe services (pipes, cables) – Pakistani team (whole week)

EN-EL: P2 diesel maintenance

Philippe/Fabio: install coat-hanger in SXL2 cleanroom SAS + fix protection box against wall + cabling inside

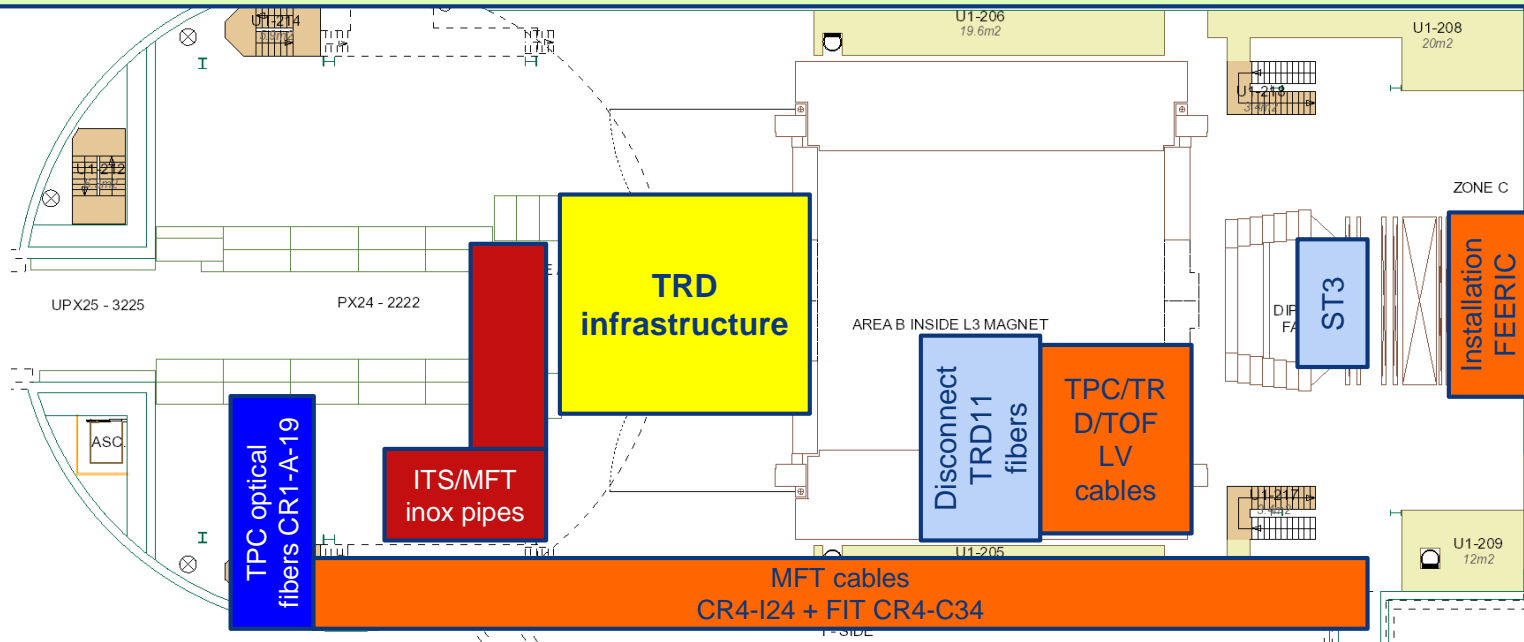

SXL2 activities w14 – Mon 1 Apr 2019

EN-HE: rent special nacelle (whole week)

Yannick: check TPC pads (Mon-Wed)

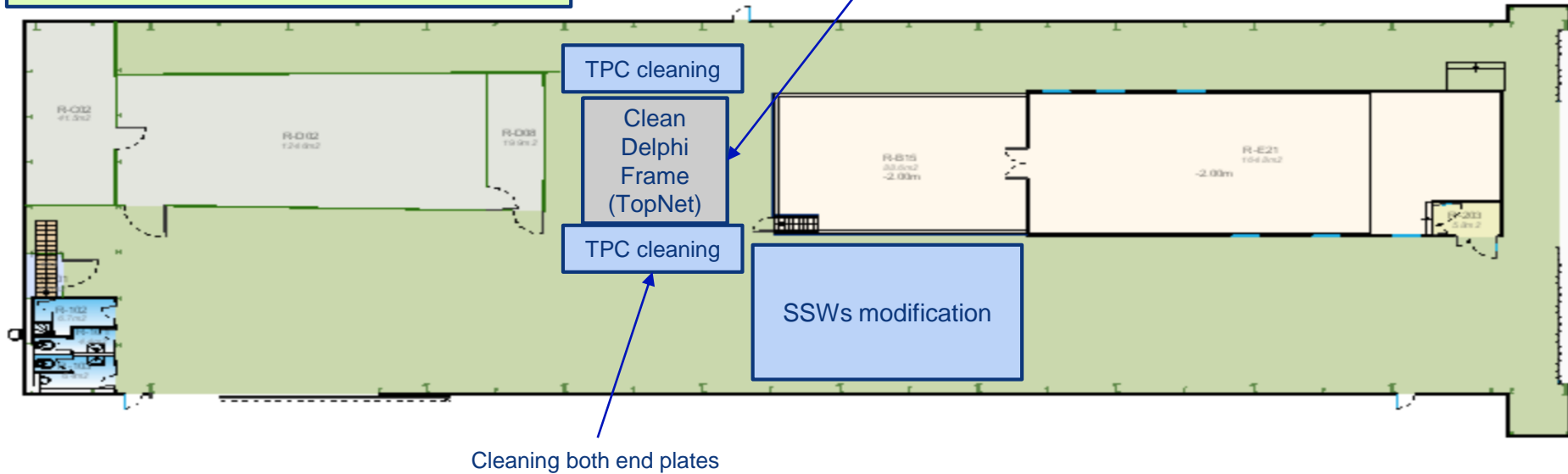

UX25 activities w14 – Tue 2 Apr 2019

Nacelle course in SX2 (PM). Need scissor nacelle (Haulotte)

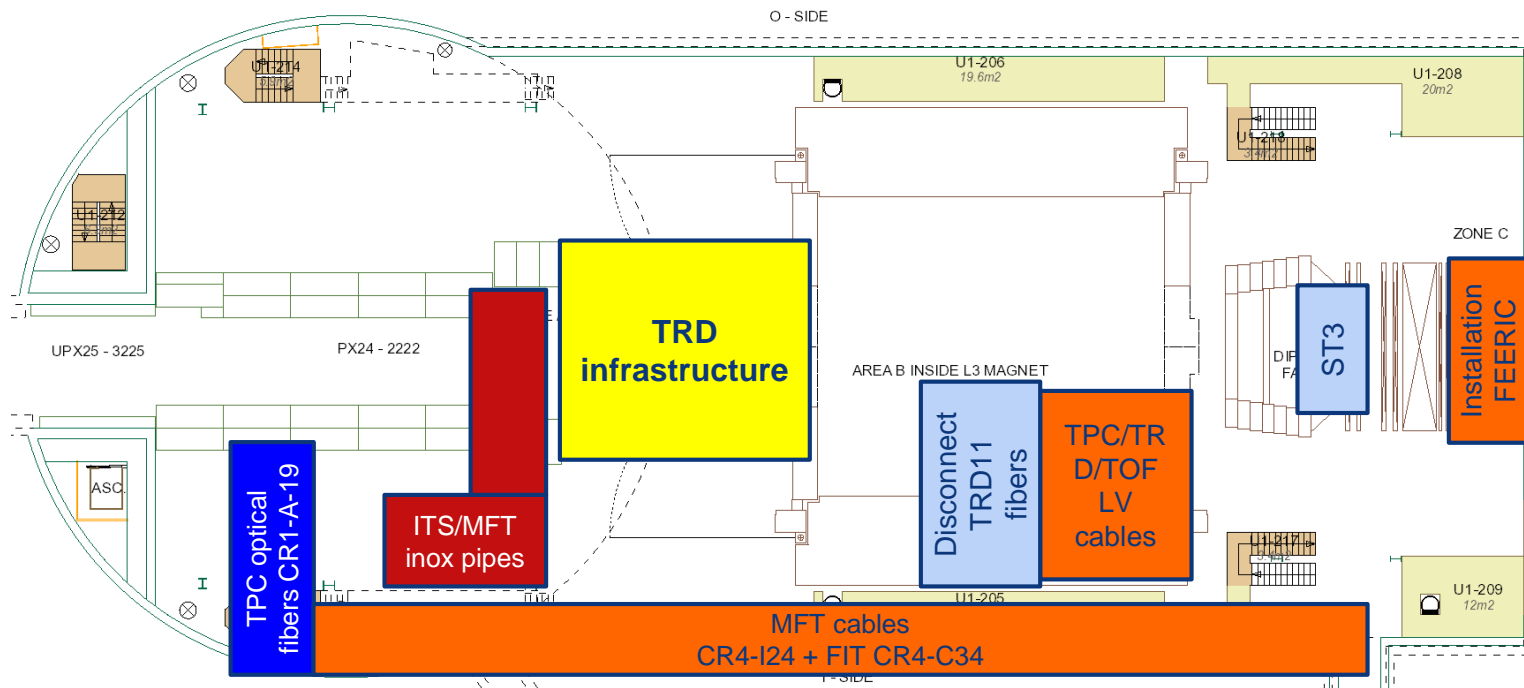

SXL2 activities w14 – Tue 2 Apr 2019

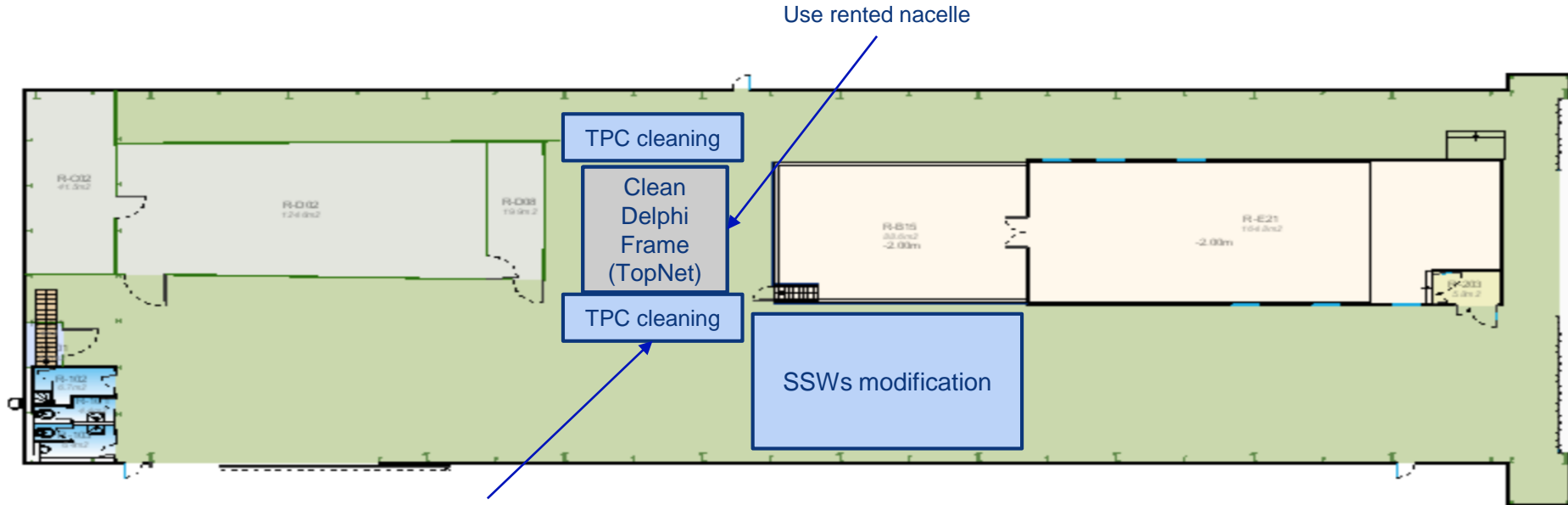

Remove some laser splitter or prism boxes on A and C sides, possibly also some camera boxes (Tue PM and Wed)

UX25 activities w14 – Wed 3 Apr 2019

Nacelle course in SX2 (all day). Need scissor nacelle (Haulotte)

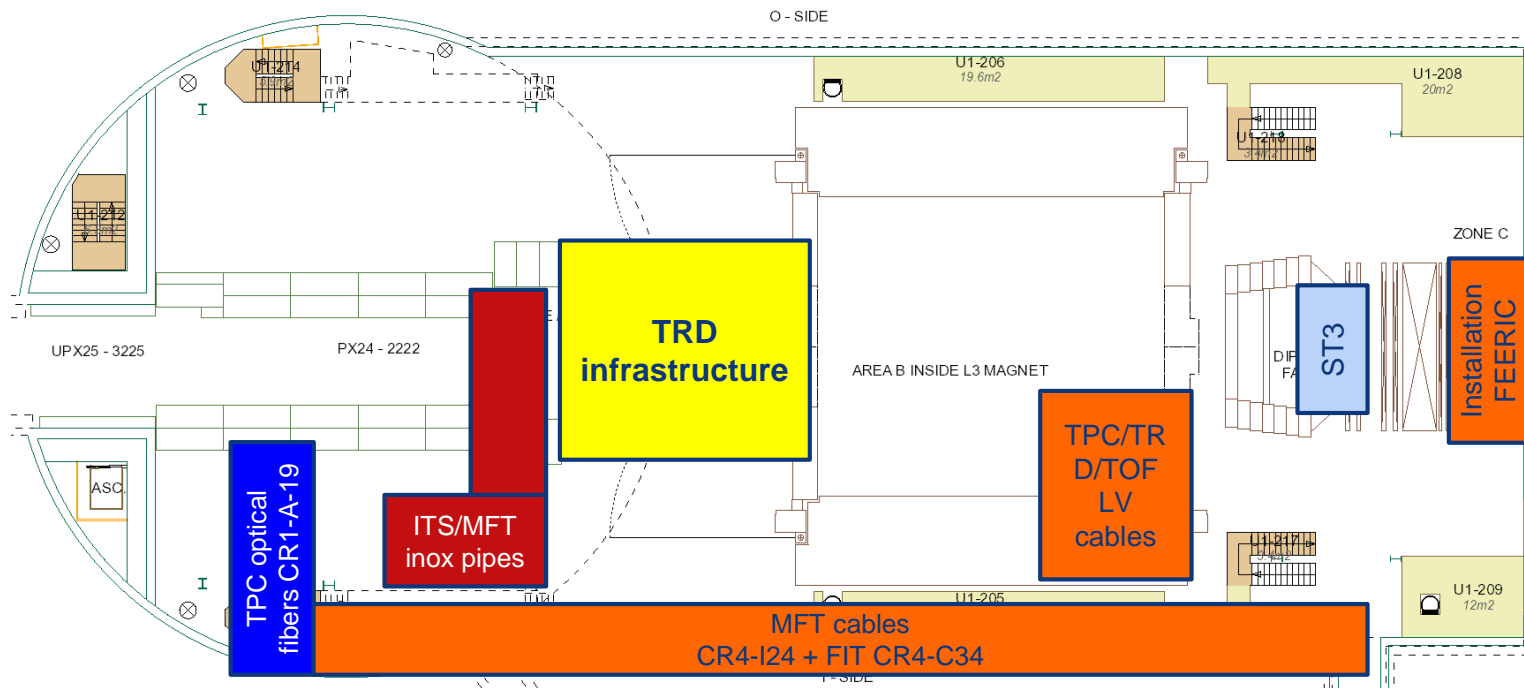

SXL2 activities w14 – Wed 3 Apr 2019

EN-CV: stop clean room ventilation around 16:00 + close air ducts (Piotr)

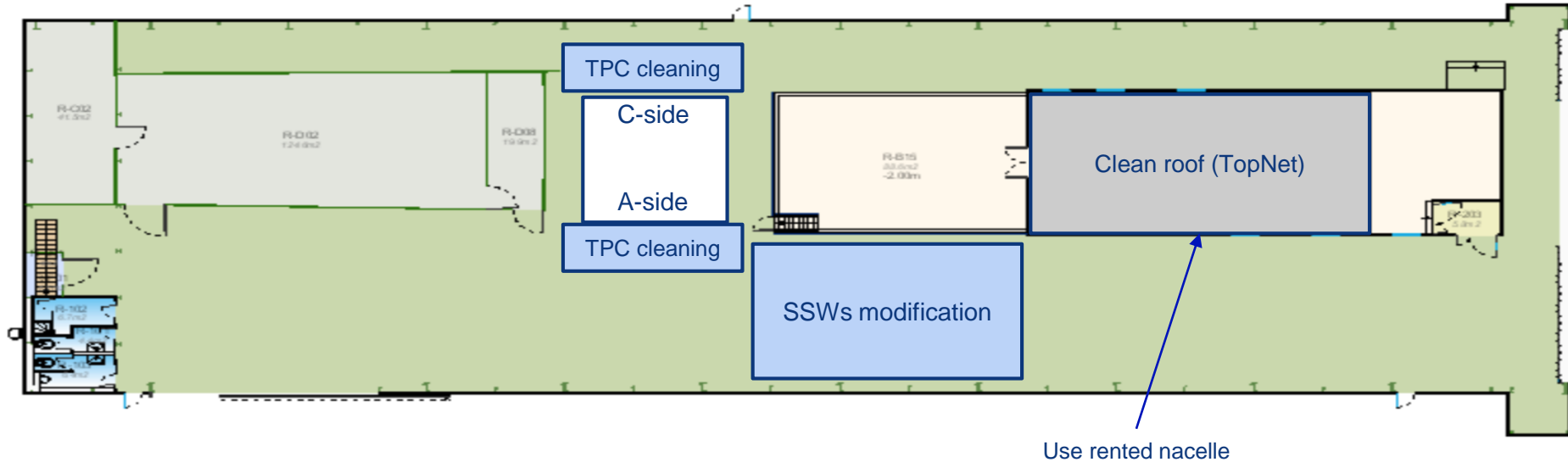

UX25 activities w14 – Thu 4 Apr 2019

Reprogram SNIFFER PLC + battery/HMI screen replacement → no access underground from 17:30 to 20:30

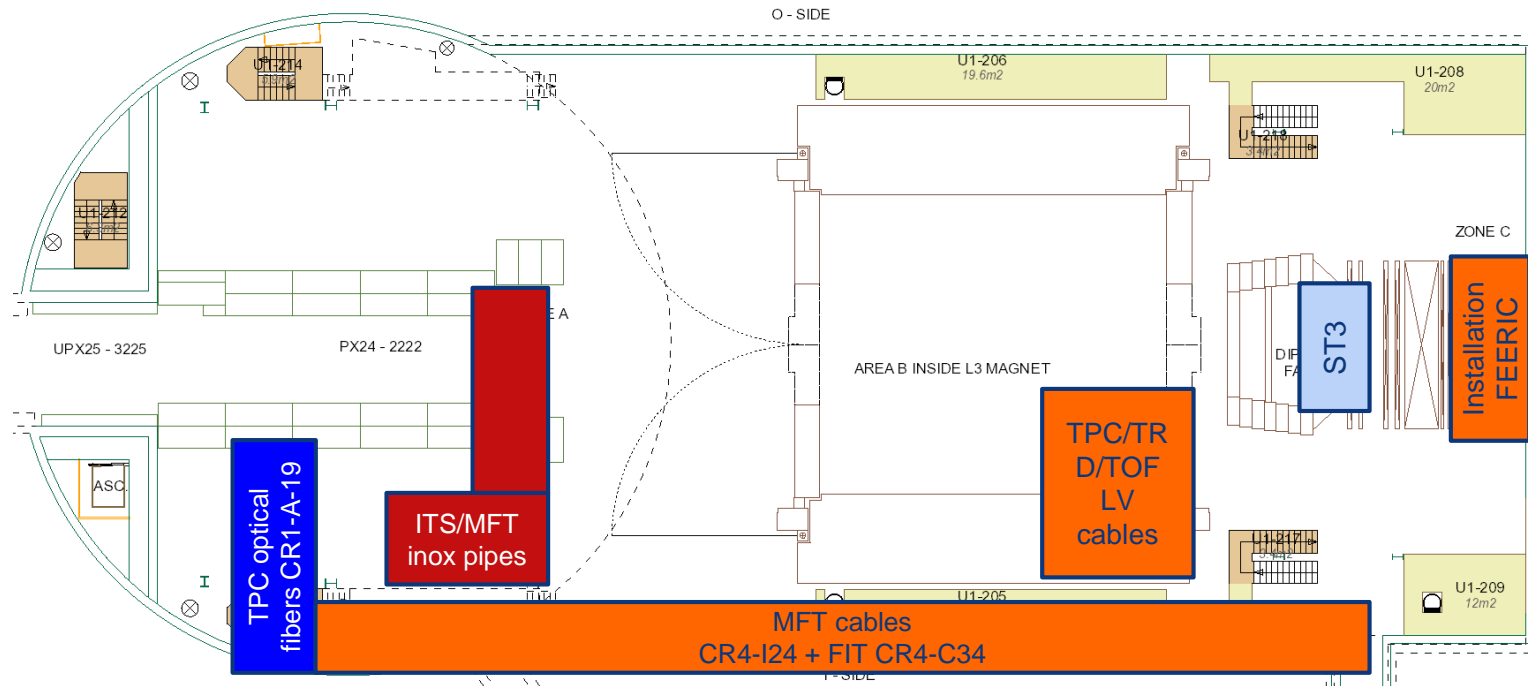

SXL2 activities w14 – Thu 4 Apr 2019

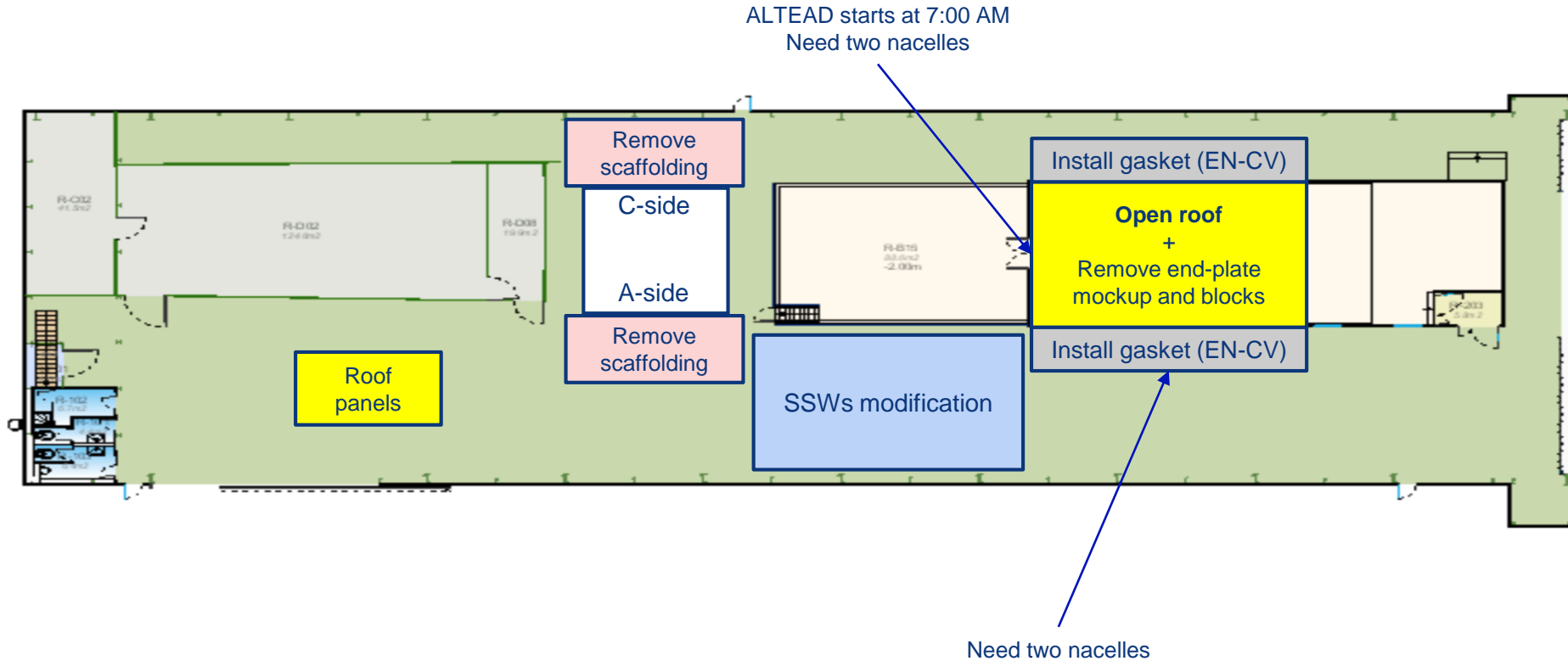

UX25 activities w14 – Fri 5 Apr 2019

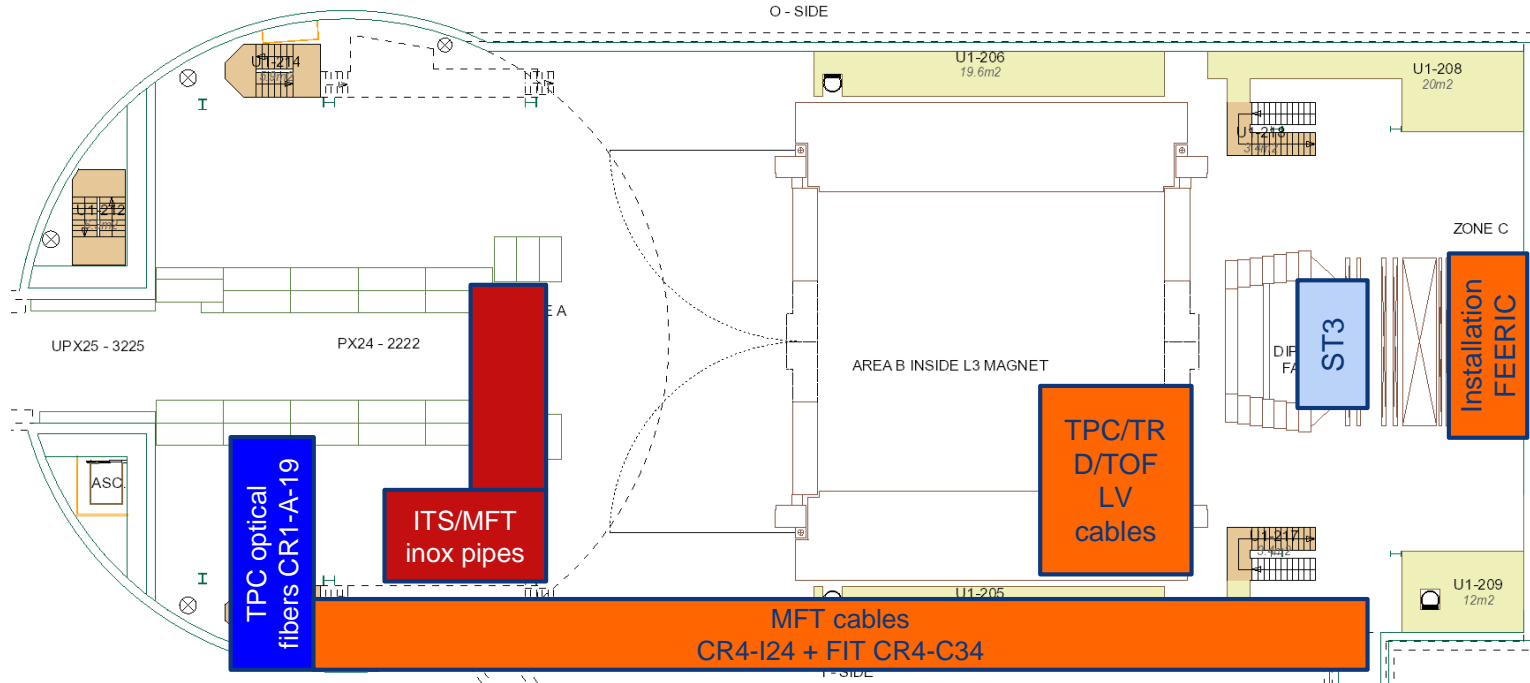

SXL2 activities w14 – Fri 5 Apr 2019

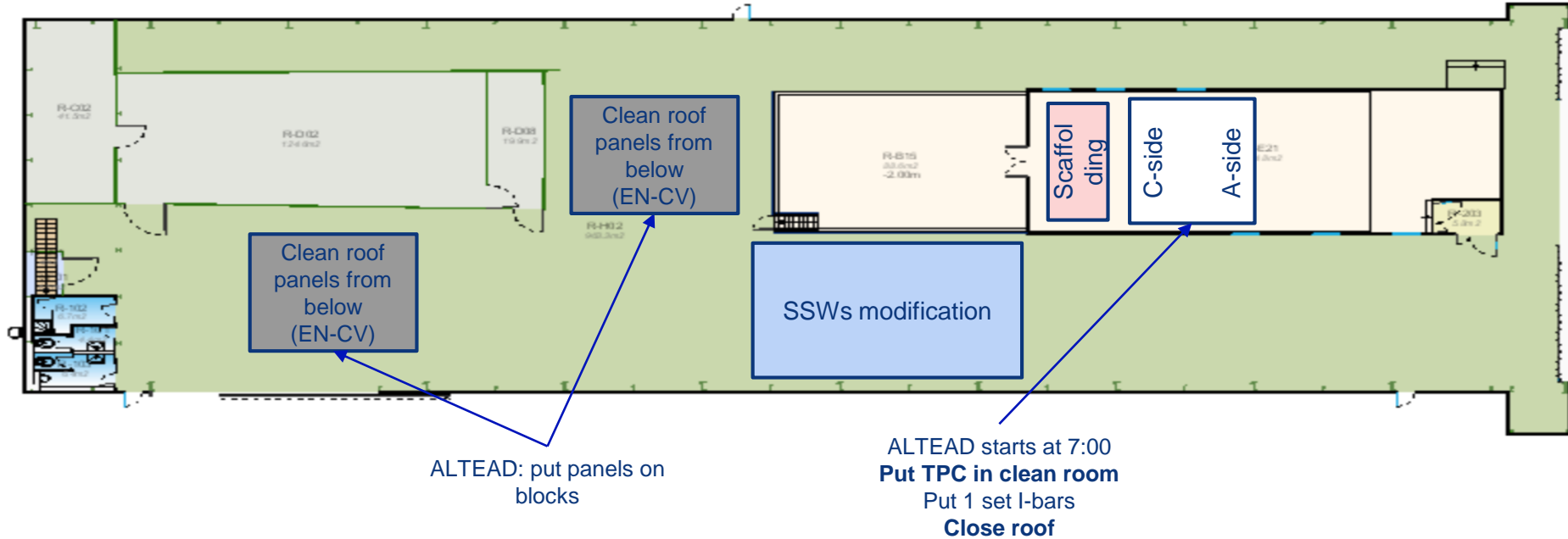

Day-by-day sequence w15

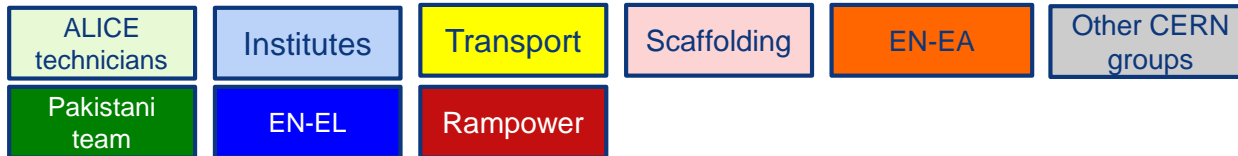

UX25 activities w15 – Mon 8 Apr 2019

Remove miniframe services (pipes, cables) – Pakistani team (whole week)

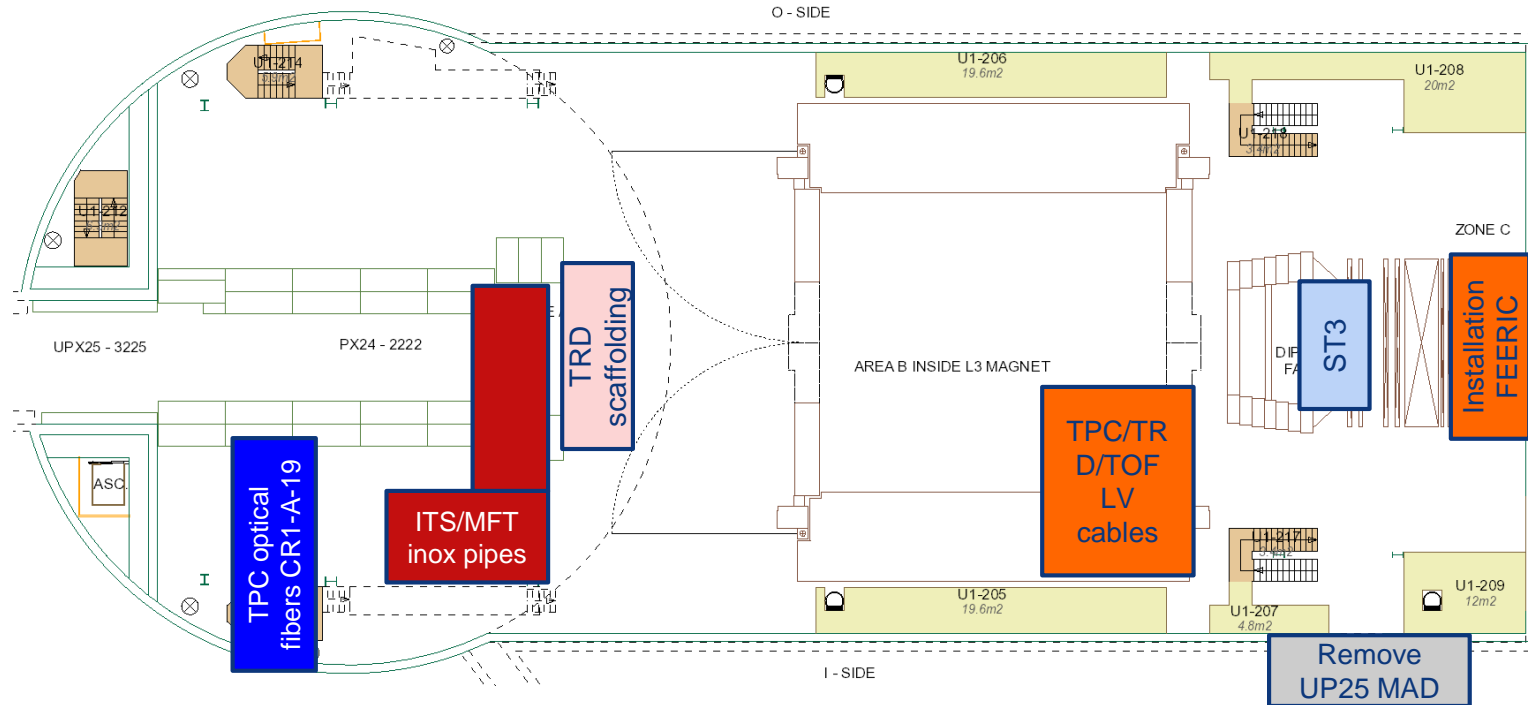

SXL2 activities w15 – Mon 8 Apr 2019

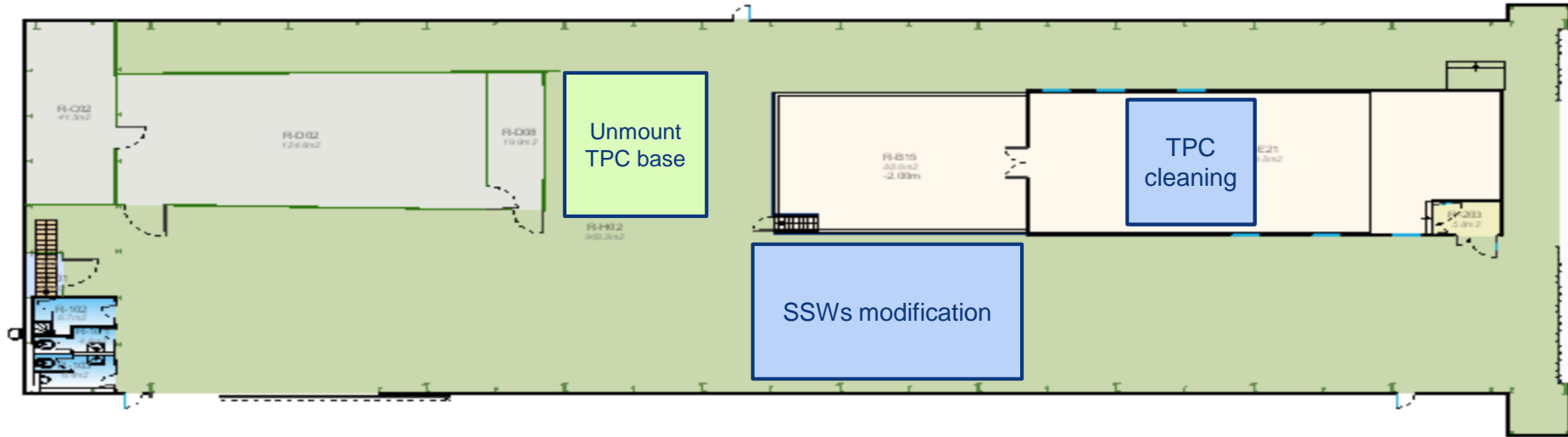

UX25 activities w15 – Tue 9 Apr 2019

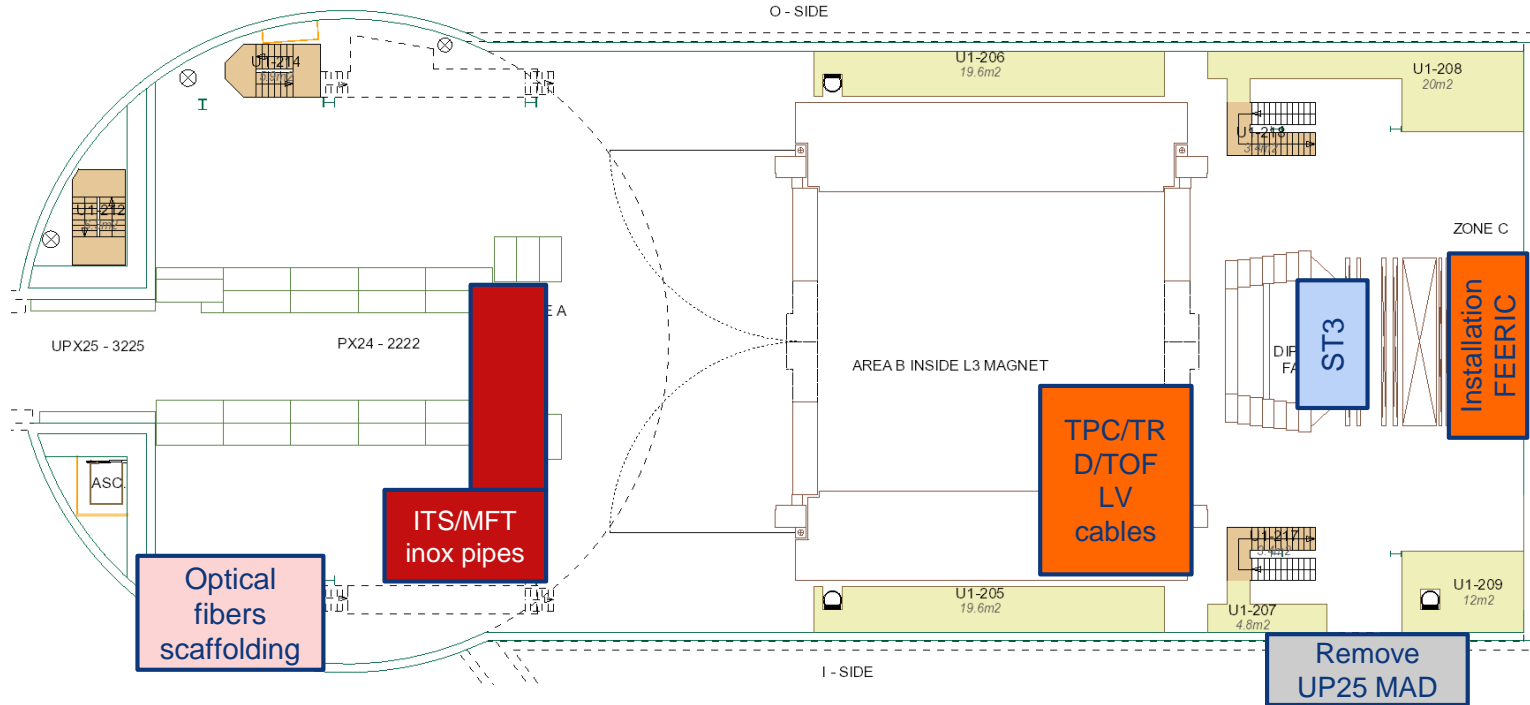

SXL2 activities w15 – Tue 9 Apr 2019

Cleanroom cleaning (DOSIM)

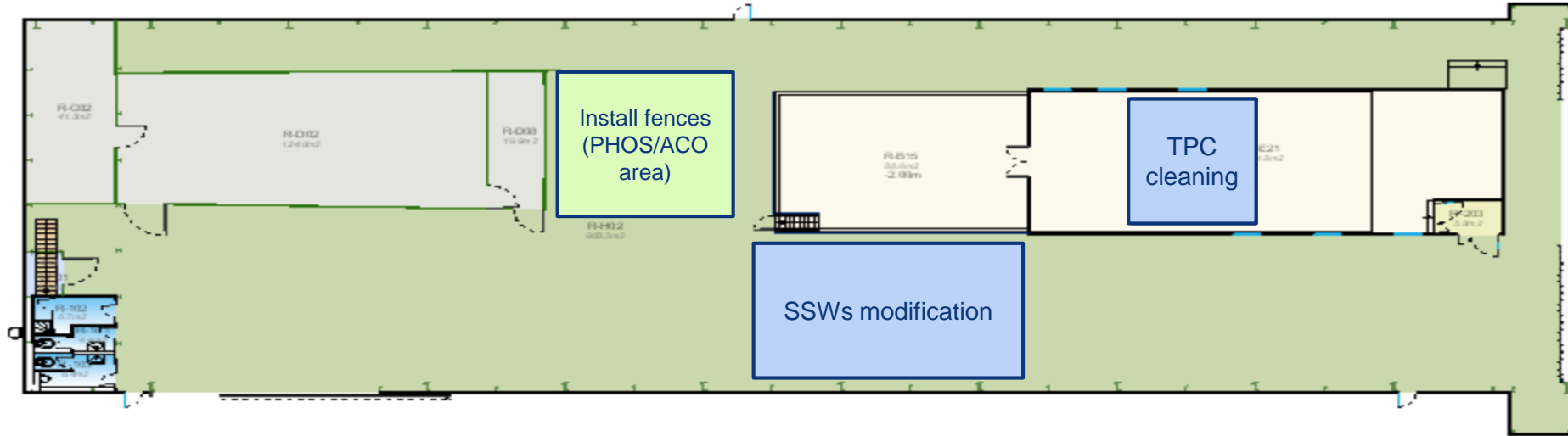

UX25 activities w15 – Wed 10 Apr 2019

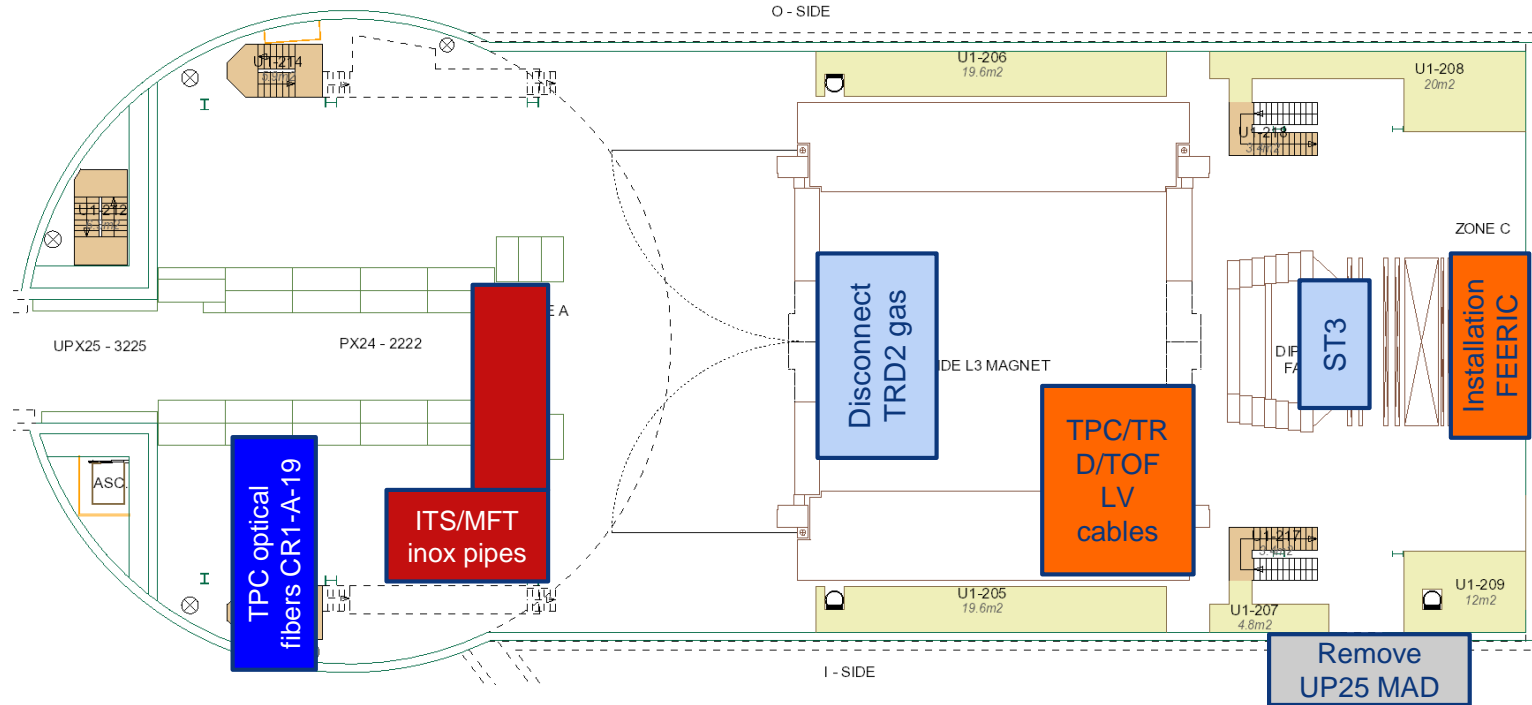

SXL2 activities w15 – Wed 10 Apr 2019

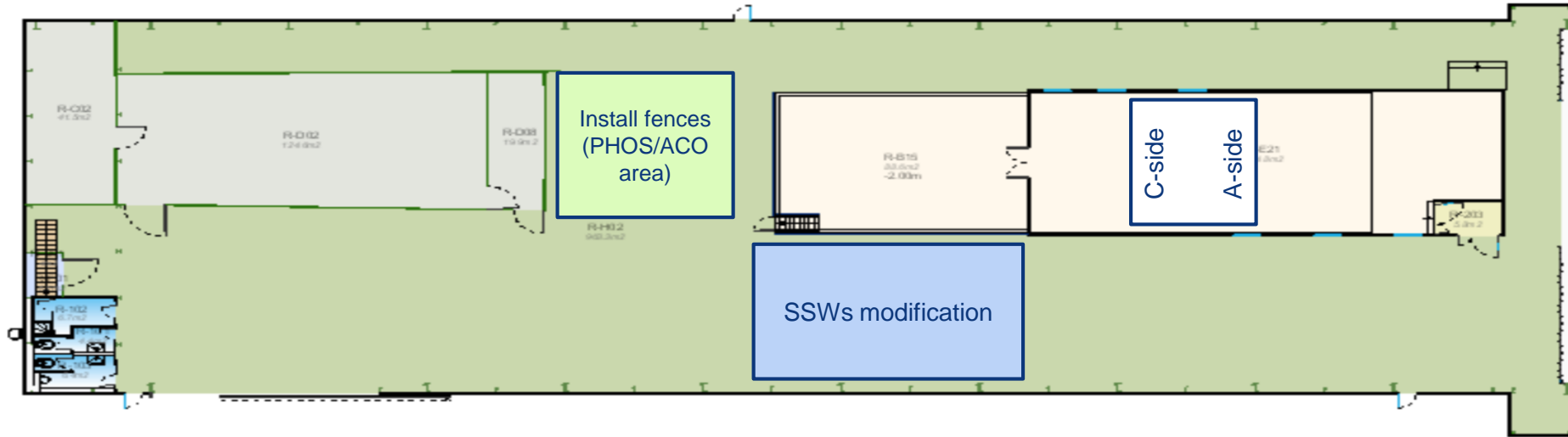

UX25 activities w15 – Thu 11 Apr 2019

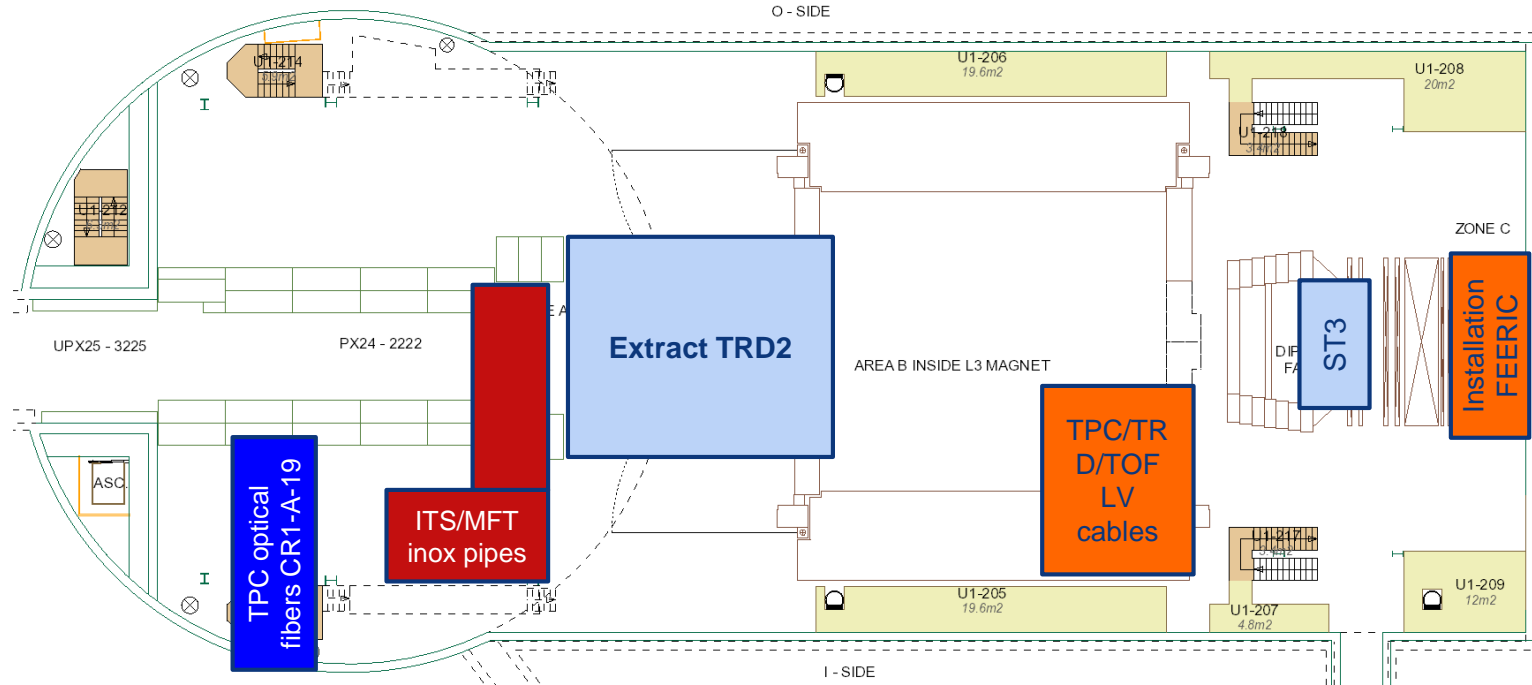

SXL2 activities w15 – Thu 11 Apr 2019

Cleanroom certification

FC tests with irradiation, cleaning of CO2 volumes – no access to SXL2 outside normal hours

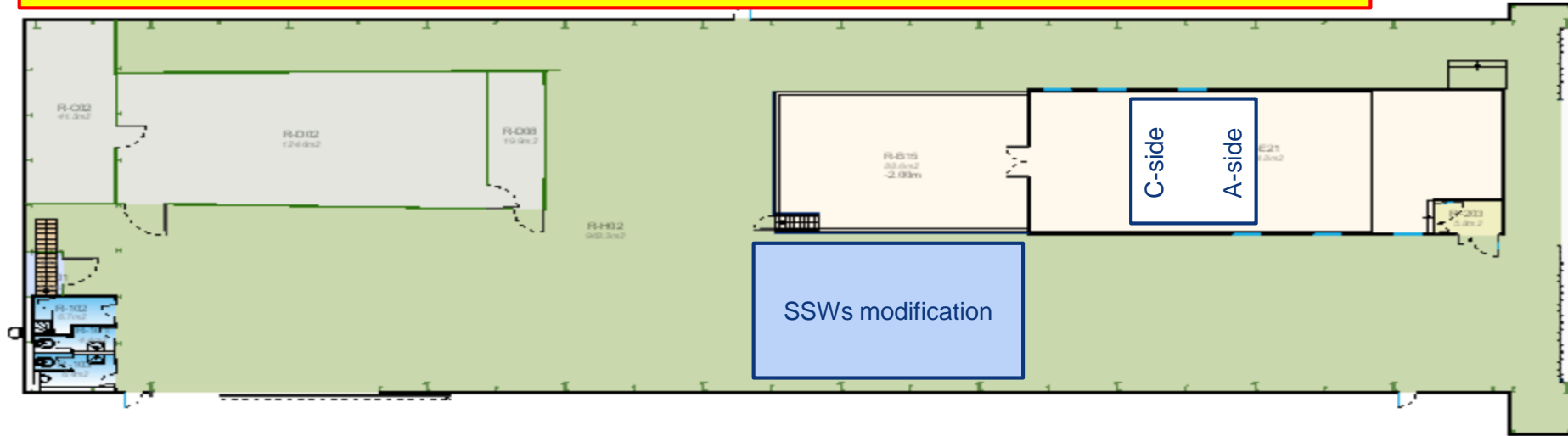

UX25 activities w15 – Fri 12 Apr 2019

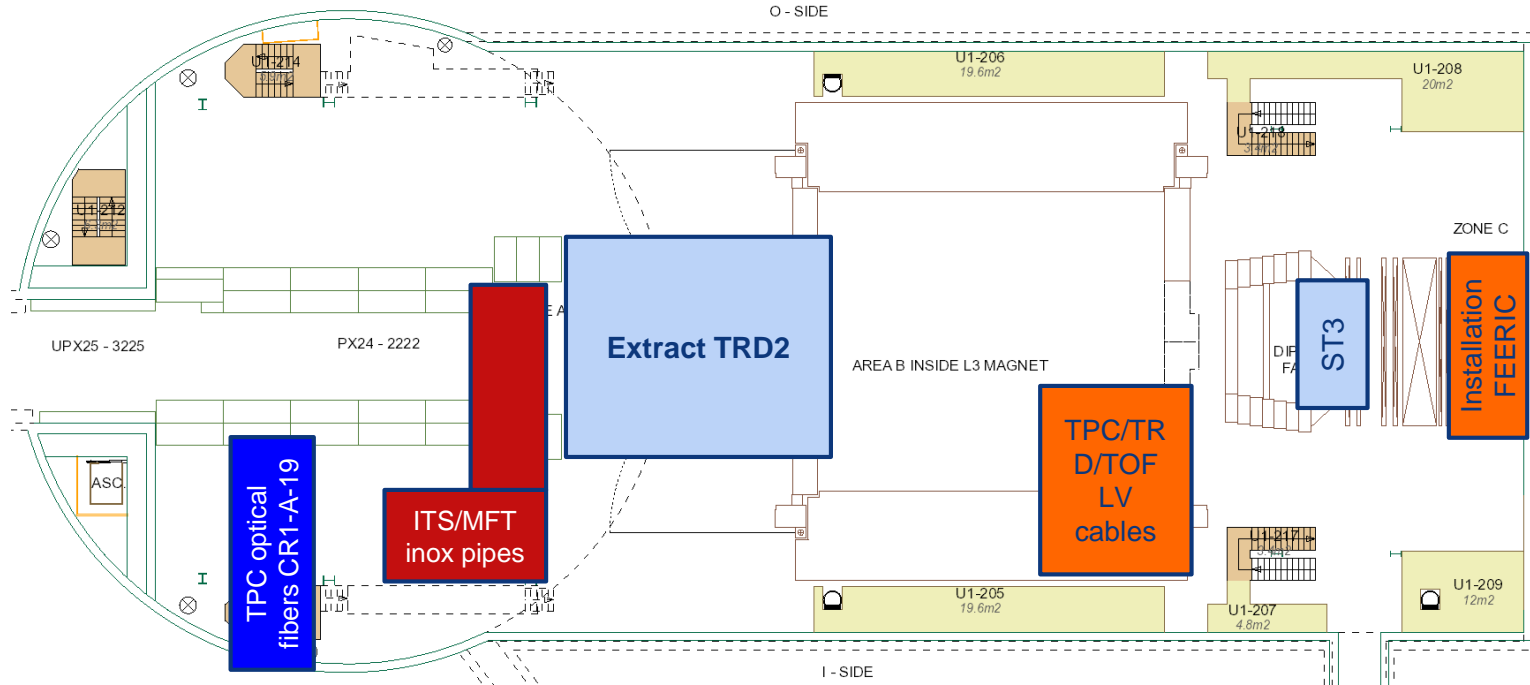

SXL2 activities w15 – Fri 12 Apr 2019

FC tests with irradiation, cleaning of CO₂ volumes – no access to SXL2 outside normal hours

