

LS2 planning meeting

A.Tauro



LS2 master plan

Gantt project

Begin date	End date
3/12/18	21/12/18
24/12/18	5/3/19
6/3/19	4/2/20
7/1/19	20/12/19
7/3/19	29/3/19
8/4/19	15/10/19
28/10/19	6/12/19
9/12/19	20/12/19
5/2/20	21/4/20
22/4/20	2/6/20
3/6/20	25/8/20
26/8/20	1/9/20
2/9/20	27/10/20
28/10/20	22/2/21

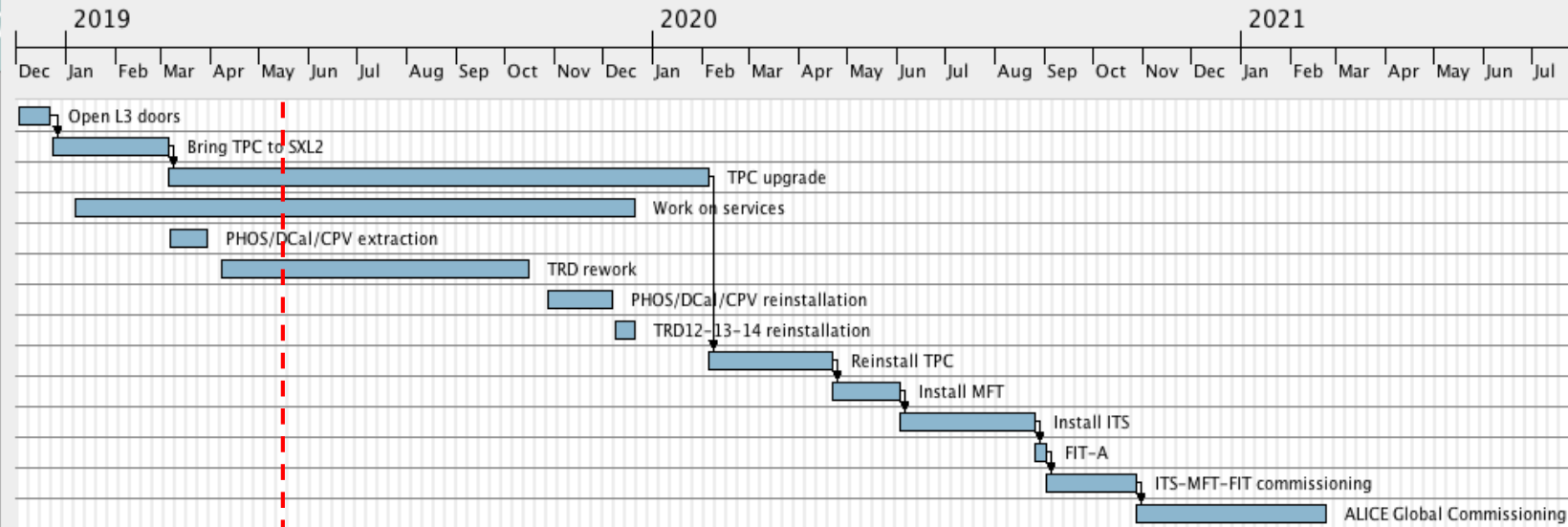

EN-EL interventions

- ~~AUG on Monday 25 March 2019 – no access on site (both surface and underground)~~
- Diesel maintenance: 1 Apr 2019 - Done
- CERN wide 66kV maintenance: 28 May 2019 to 19 July 2019 – reduced consumption (i.e. no magnets)
- Test secours (10 min): 19 Dec 2019 from 8:00 AM to 11:00 AM
- 18kV, 3.3kV and LV network maintenance:
 - Mon 20 to Wed 22 Jan 2020: 3 days no general services - no access on site (both surface and underground)
 - Thu 23 to Fri 24 Jan 2020: 2 days “Limited access” → details being worked out
- AUG on Monday 27 January 2020 - no access on site (both surface and underground)
- Auto transfer test: 27-29 Apr 2020
- BIW test: 5 and 6 Oct 2020 from 18:00 to 00:00 – no access underground

EN-CV interventions

- **Big maintenance:**

- SF: from Nov 2019 to mid Jan 2020. NO impact on ALICE as both magnets will be OFF.
- UW: **stop UX mixed water** for 2 days in week 40/2019 (October).
- SU: various small perturbations + 1 day **stop all cooling UX** + 1 day **stop all cooling SXL2** in week 16/2020 (April).

- **Small maintenance:**

- UW: from mid Aug 2020 to mid Sep 2020. **Stop mixed water UX** for 1 day in week 37/2020 (September).
- SF+SU: weeks 45-47/2020: cleaning towers (stop SF 1 week) + 1 day **stop all cooling UX**.

- **Ventilation:**

- SG2: w7/2019 - Done
- Gas extraction: w8/2019 - Done
- UX25 cavern: May 2020 (tbc)
- MCH and MTG: Apr 2020 (tbc)
- L3: Apr 2020 (tbc)
- ITS: Apr 2020 (tbc)

- **Raw water:**

- Test after Apr 2019. Short interruption (1 day), can be used tap water during the test.

CERN Open Days

- Sat 14 and Sun 15 September 2019
- Open Low-Beta platform and put scaffolding

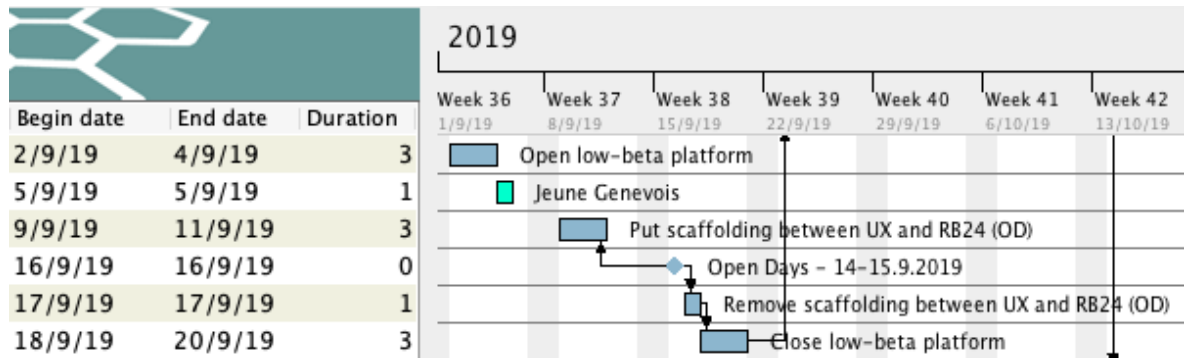

TRD schedule – new dates

	Begin date	End date	Durat...
Rework TRD2/6	11/4/19	17/5/19	27
Reinstall TRD2	20/5/19	20/5/19	1
Install TRD6 infrastr...	21/5/19	22/5/19	2
Reinstall TRD6	23/5/19	23/5/19	1
Install TRD7 infrastr...	24/5/19	24/5/19	1
Modify TRD scaffold...	27/5/19	27/5/19	1
Ascension	30/5/19	30/5/19	1
Remove TRD7	3/6/19	3/6/19	1
Install TRD1 infrastr...	4/6/19	4/6/19	1
Remove TRD1	5/6/19	5/6/19	1
Survey SF	6/6/19	6/6/19	1
Install TRD0 infrastr...	6/6/19	10/6/19	1
Pentecote	10/6/19	10/6/19	1
Remove TRD0	24/6/19	24/6/19	1
Install TRD8 infrastr...	25/6/19	25/6/19	1
Remove TRD8	26/6/19	26/6/19	1
Rework TRD7/1/0/8	27/6/19	26/7/19	22
Reinstall TRD8	29/7/19	29/7/19	1
Install TRD0 infrastr...	30/7/19	31/7/19	2
Reinstall TRD0	1/8/19	1/8/19	1
Install TRD1 infrastr...	2/8/19	5/8/19	2
Reinstall TRD1	6/8/19	6/8/19	1
Install TRD7 infrastr...	7/8/19	8/8/19	2
Reinstall TRD7	9/8/19	9/8/19	1
Install TRD16 infras...	12/8/19	13/8/19	2
Remove TRD16	14/8/19	14/8/19	1
Install TRD10 infras...	15/8/19	15/8/19	1
Remove TRD10	16/8/19	16/8/19	1
Rework TRD16/10	19/8/19	20/9/19	25
Jeune Genevois	5/9/19	5/9/19	1
Open Days prepara...	2/9/19	20/9/19	15
Reinstall TRD10	23/9/19	24/9/19	2
Install TRD16 infras...	25/9/19	26/9/19	2
Reinstall TRD16	27/9/19	27/9/19	1
Install TRD13 infras...	30/9/19	1/10/19	2
Remove TRD13	2/10/19	2/10/19	1
Install CW13	3/10/19	4/10/19	2
Install TRD12 infras...	7/10/19	8/10/19	2
Remove TRD12	9/10/19	9/10/19	1
Install TRD14 infras...	10/10/19	10/10/19	1
Remove TRD14	11/10/19	11/10/19	1
Rework TRD12/13/...	14/10/19	6/12/19	40
Reinstallation PHOS...	28/10/19	6/12/19	30
Install TRD14 infras...	9/12/19	10/12/19	2
Reinstall TRD14	11/12/19	11/12/19	1
Install TRD12 infras...	12/12/19	13/12/19	2
Reinstall TRD12	16/12/19	16/12/19	1
Install TRD13 infras...	17/12/19	18/12/19	2
Remove CW13	19/12/19	19/12/19	1
Reinstall TRD13	20/12/19	20/12/19	1
Xmas break	23/12/19	3/1/20	10
Final TRD survey	6/1/20	7/1/20	2

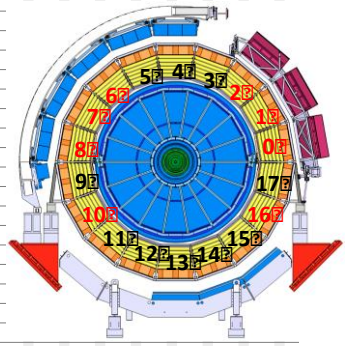
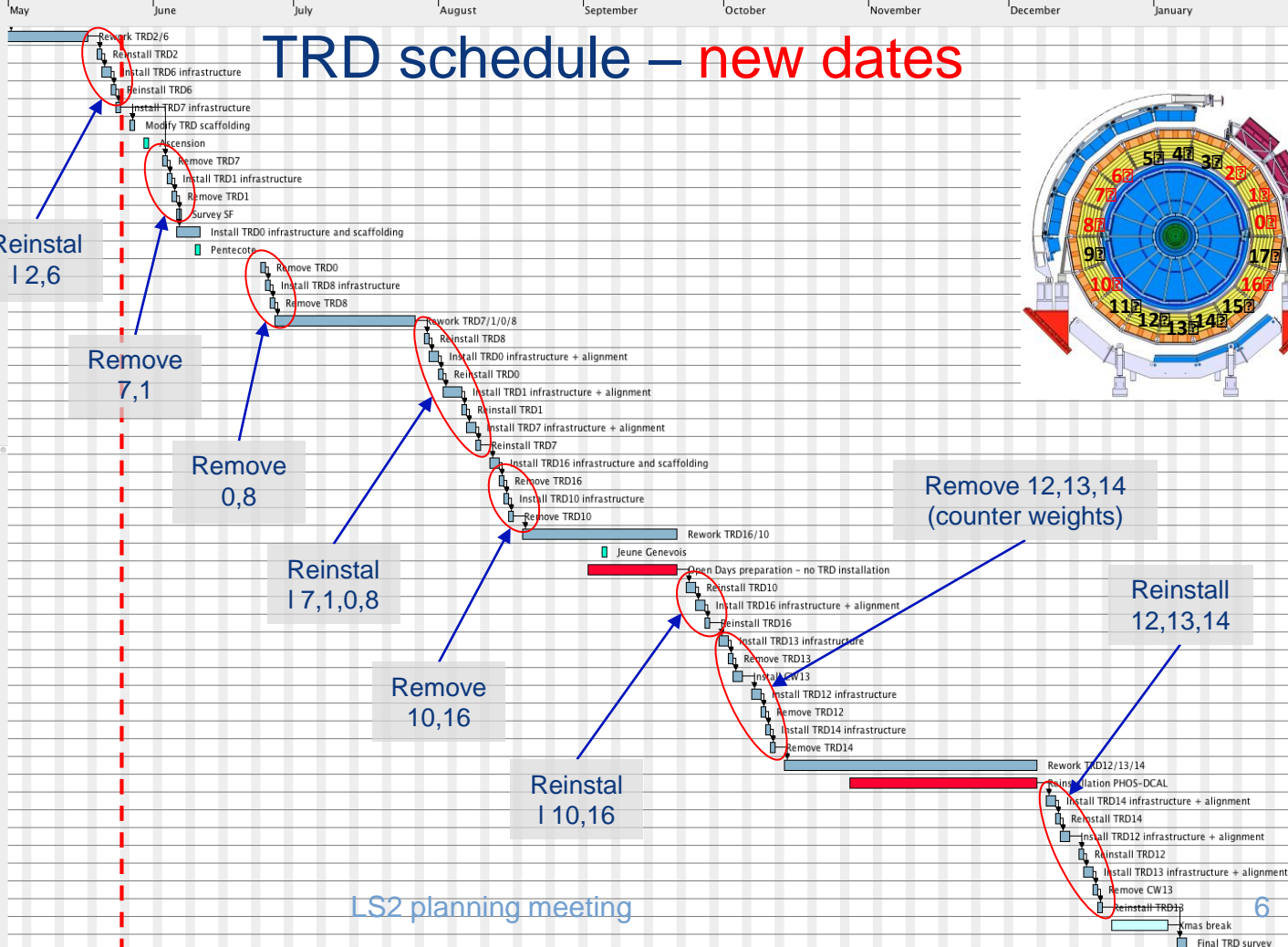

LS2 planning meeting

TPC upgrade sequence

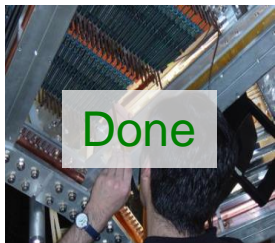

**Remove FEE
outside cleanroom**

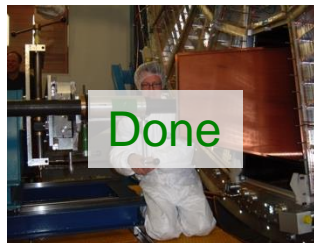

Remove ROC



**Survey, sealing,
OVP test**

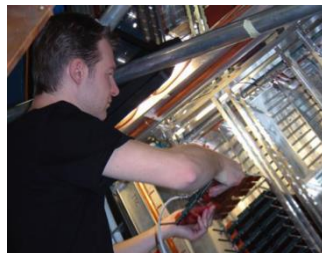

**Install new FEC +
test**

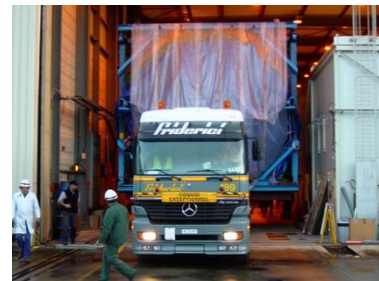

**TPC ready for
transportation**



**TPC in cleanroom
Irradiation tests**



Install new ROC

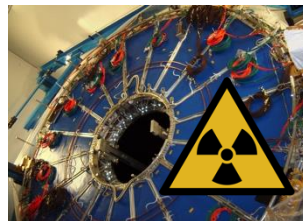

Irradiation tests

7 Mar '19

5 Apr

24 Apr (A)
1 Jul (C)

10 May (A)
12 Jul (C)

28 May – 17 Jun (A)
23 Jul – 8 Aug (C)

11 Sep (A)
26 Sep (C)

19 Dec

4 Feb '20

TPC schedule – Apr-Jul

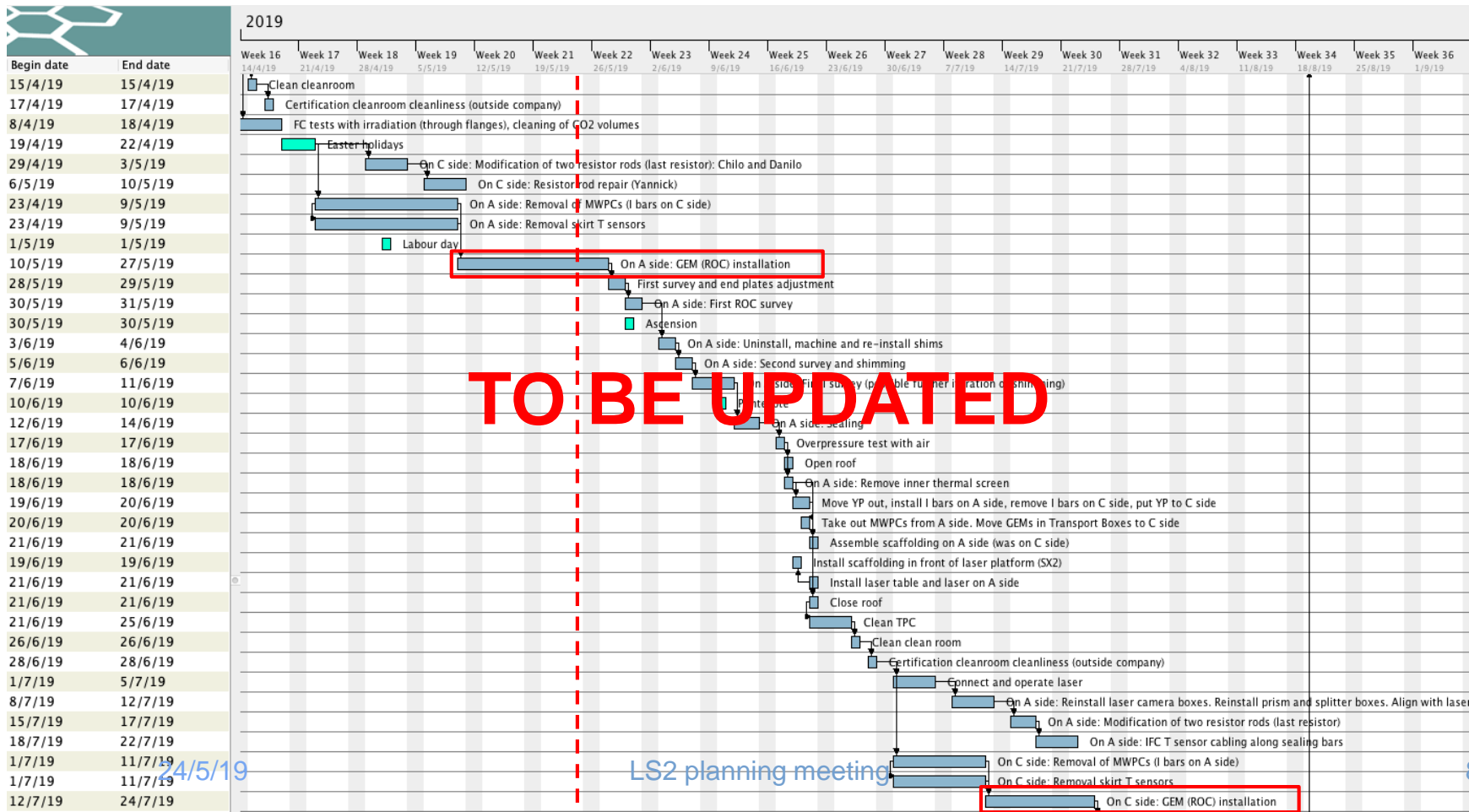

TO BE UPDATED

LS2 planning meeting

4/5/19

Copper cables (EN-EA)



Begin date	End date	Dura...
11/3/19	14/3/19	4
15/3/19	26/3/19	8
27/3/19	29/3/19	3
1/4/19	5/4/19	5
8/4/19	12/4/19	5
15/4/19	19/4/19	5
22/4/19	26/4/19	5
29/4/19	14/5/19	12
15/5/19	24/5/19	8
27/5/19	31/5/19	5
3/6/19	7/6/19	5
10/6/19	14/6/19	5
17/6/19	20/6/19	4
21/6/19	21/6/19	1
24/6/19	28/6/19	5
1/7/19	5/7/19	5
8/7/19	17/7/19	8
18/7/19	19/7/19	2
22/7/19	23/7/19	2
18/3/19	19/7/19	90

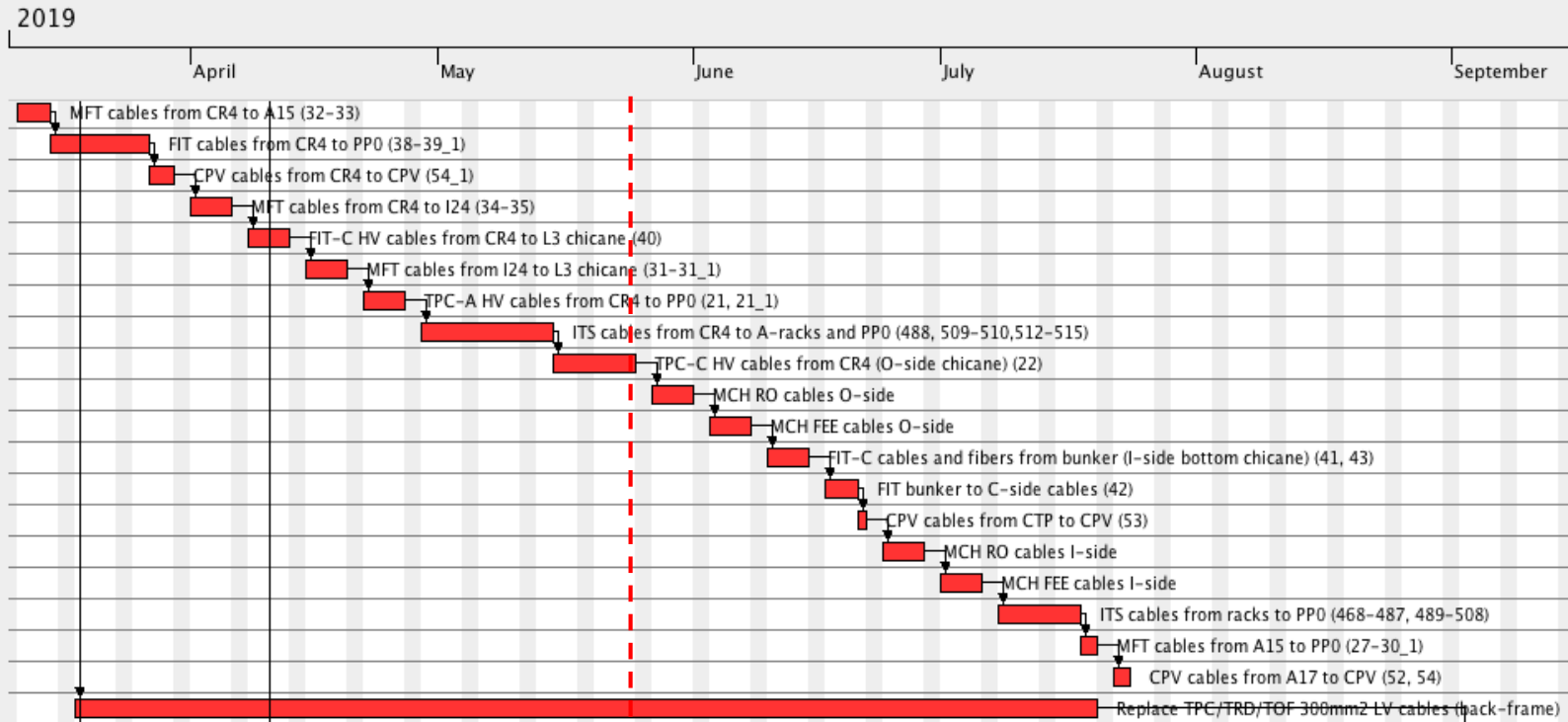

Copper cables (EN-EA)

ALICE LS2 - EN-EA cabling control follow-up

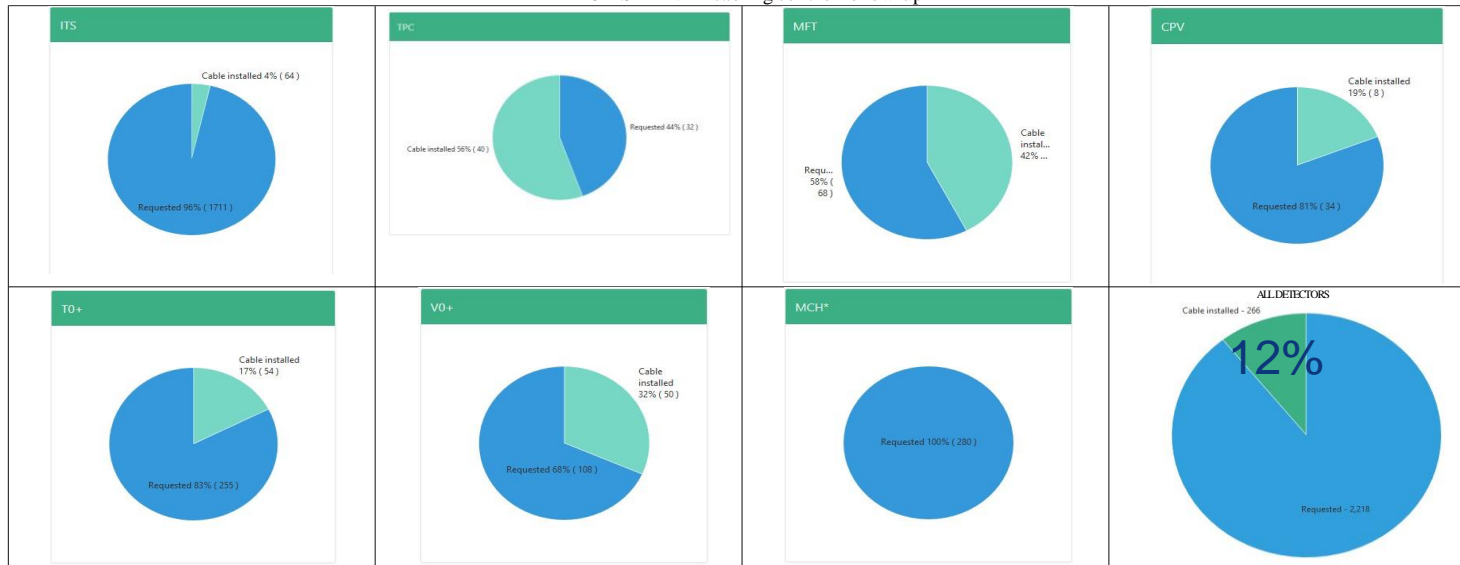

Copper cables – dates completion connectors + test (EN-EA)

Cavern:

- TPC : 29/10/2019
- ITS : 19/11/2019
- MFT : 27/11/2019
- FIT : 3/12/2019
- CPV : 21/10/2019
- MCH : 10/07/2019

This is a proposal, please check these dates

Miniframe:

- TPC : 03/02/2020
- ITS : 04/03/2020
- MFT : 11/03/2020
- FIT : 03/03/2020

Optical fibers (EN-EL)

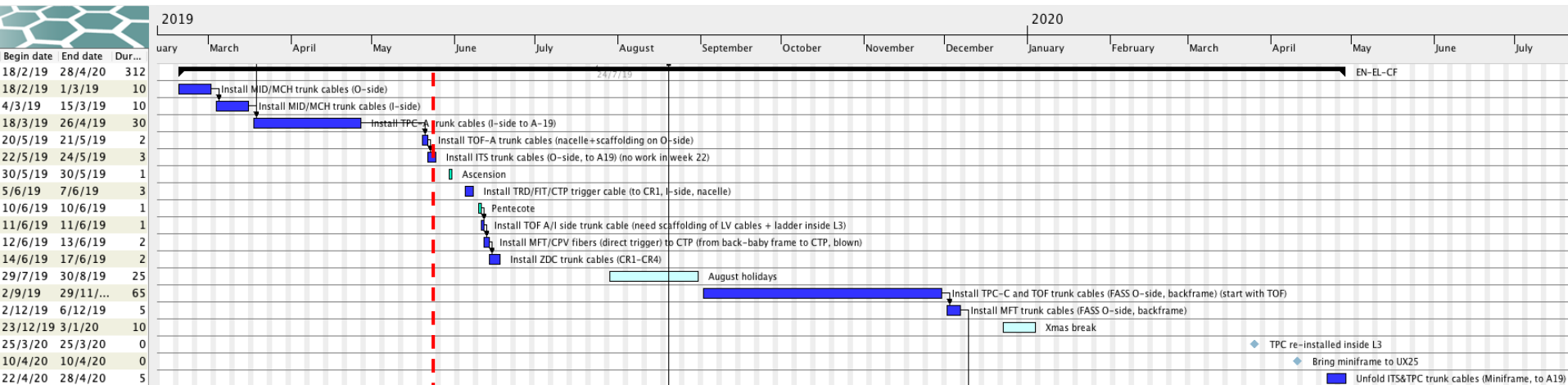

Miniframe planning

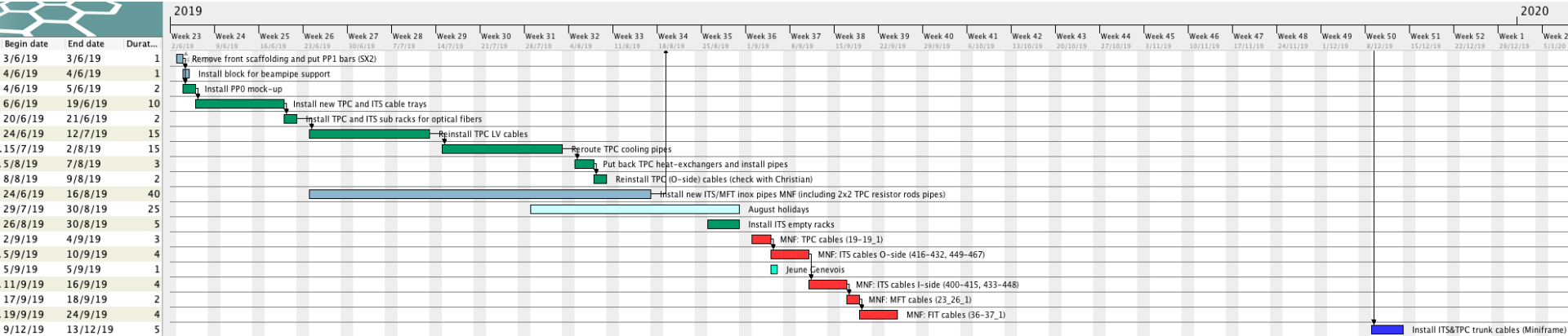

CR0 planning (draft)

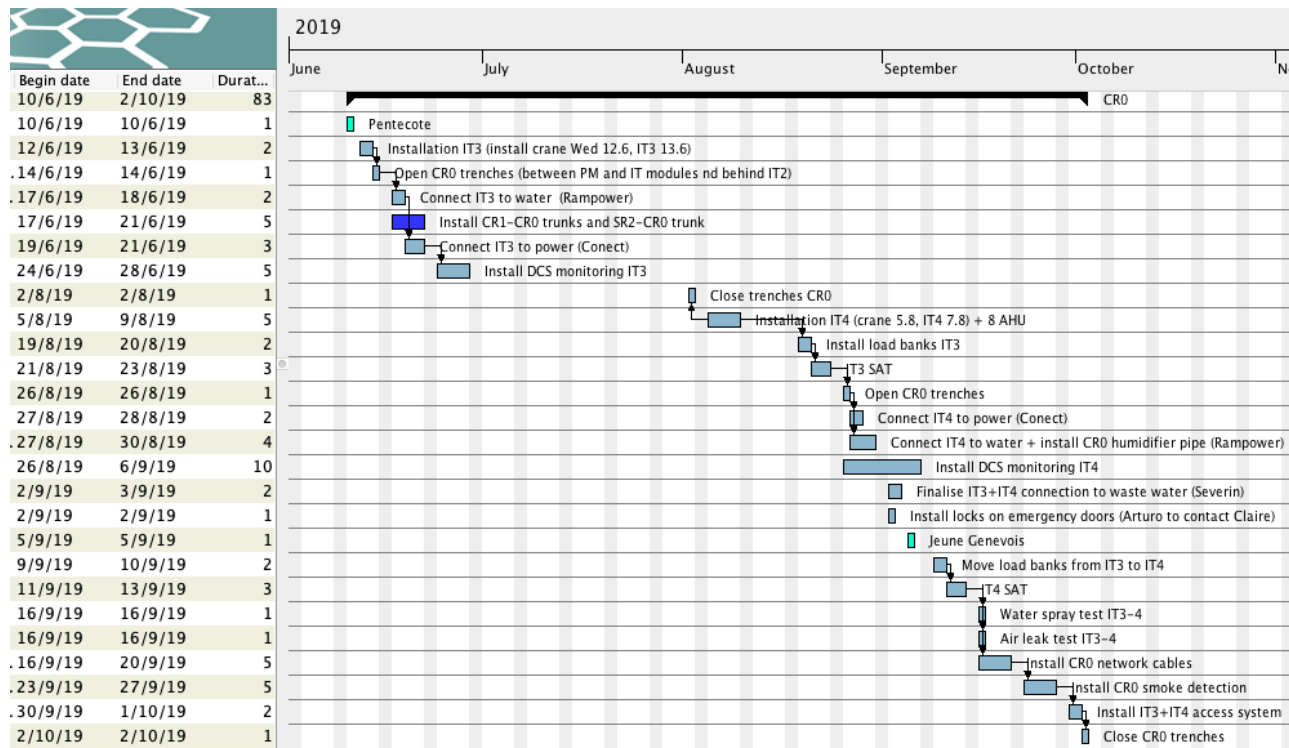

Day-by-day sequence w21

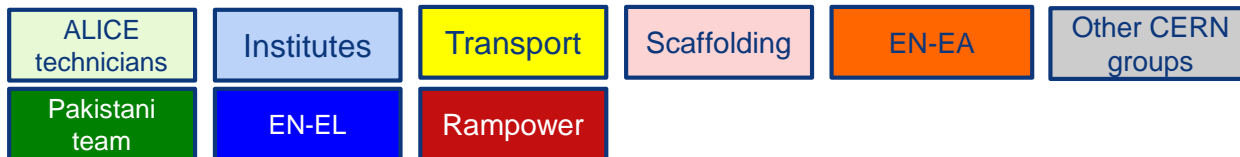

UX25 activities w21 – Mon 20 May 2019

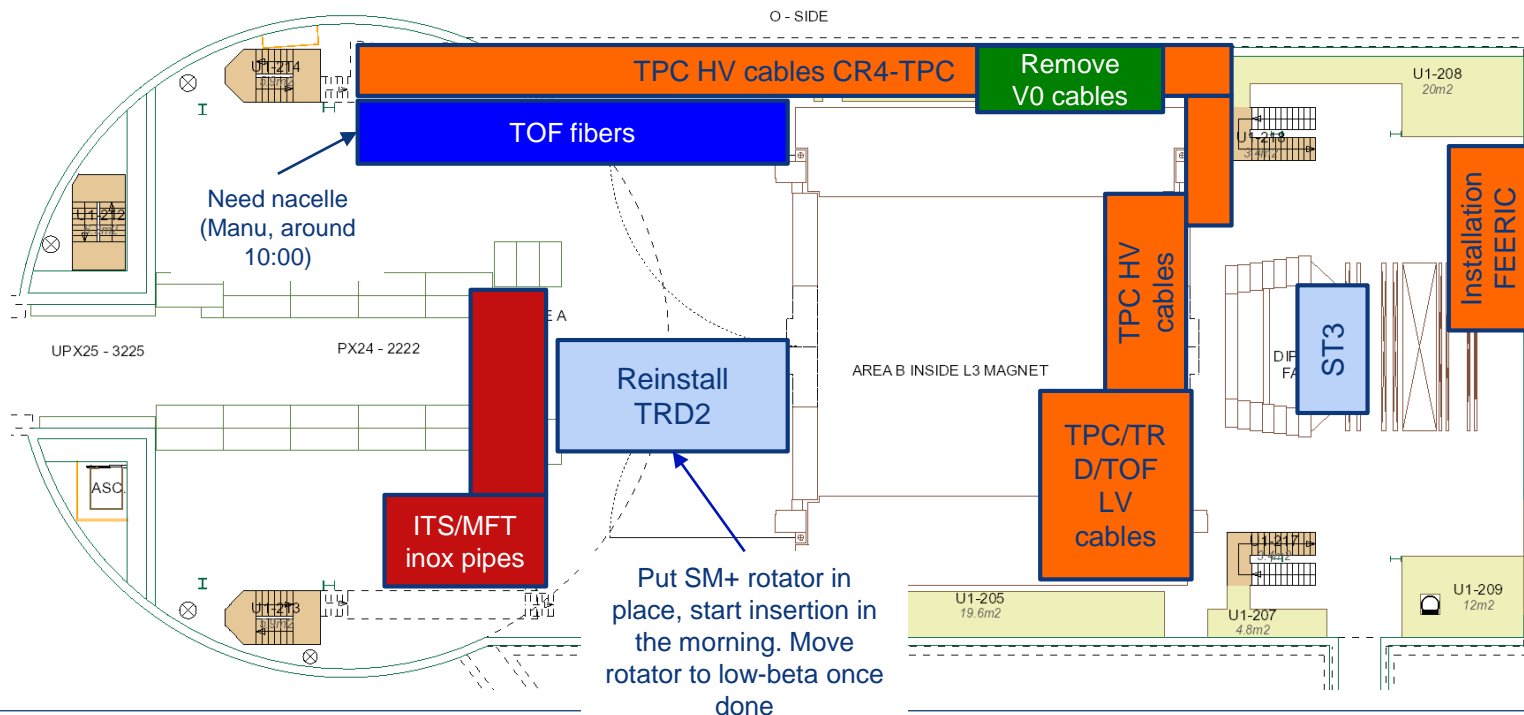

SXL2 activities w21 – Mon 20 May 2019

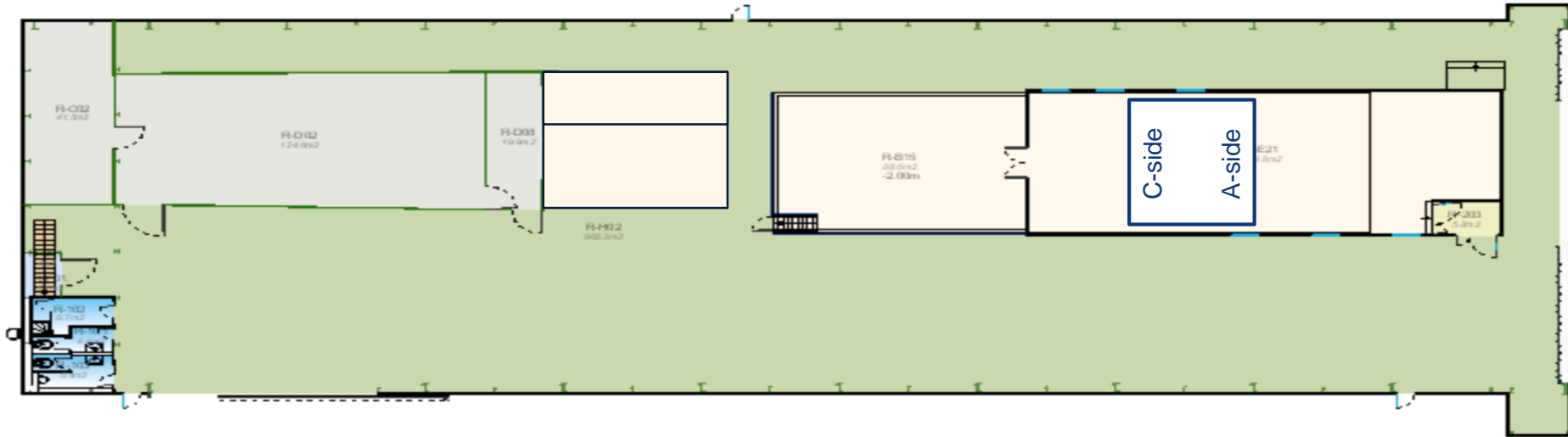

UX25 activities w21 – Tue 21 May 2019

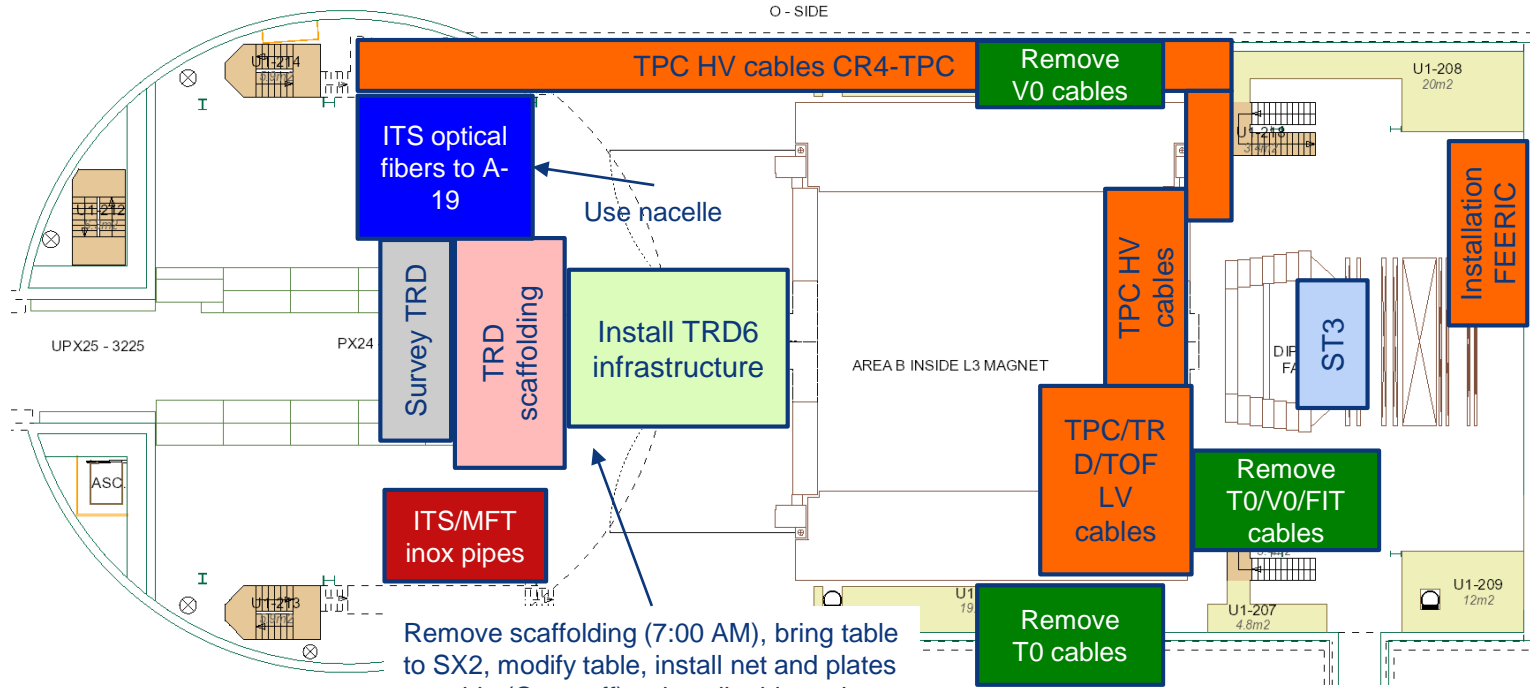

Remove scaffolding (7:00 AM), bring table to SX2, modify table, install net and plates on table (Ouvaroff), reinstall table and scaffolding (not later than 16:00)

SXL2 activities w21 – Tue 21 May 2019

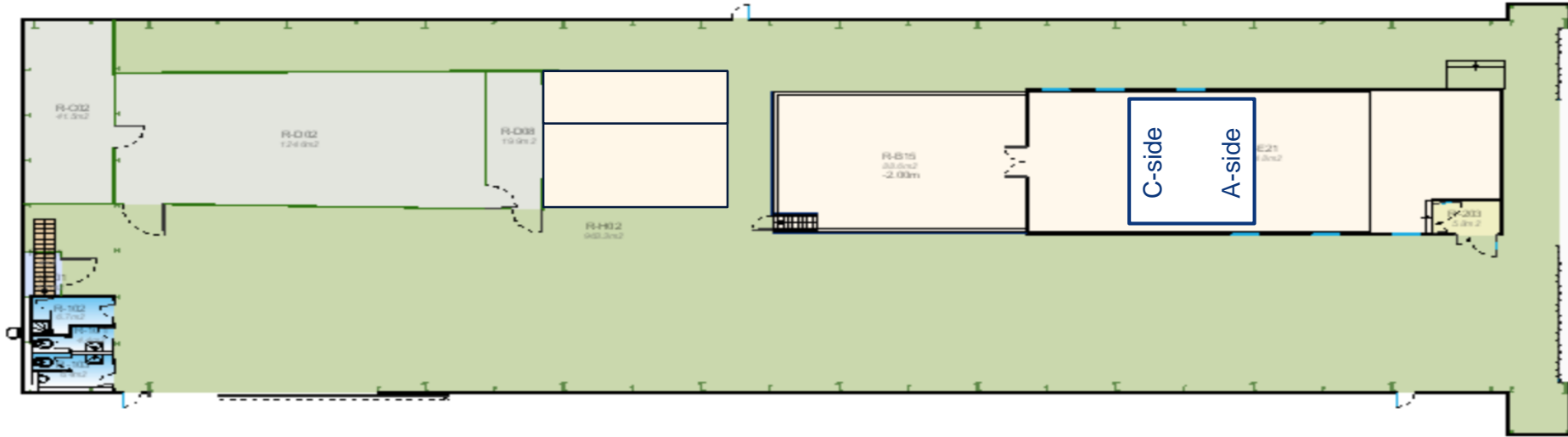

UX25 activities w21 – Wed 22 May 2019

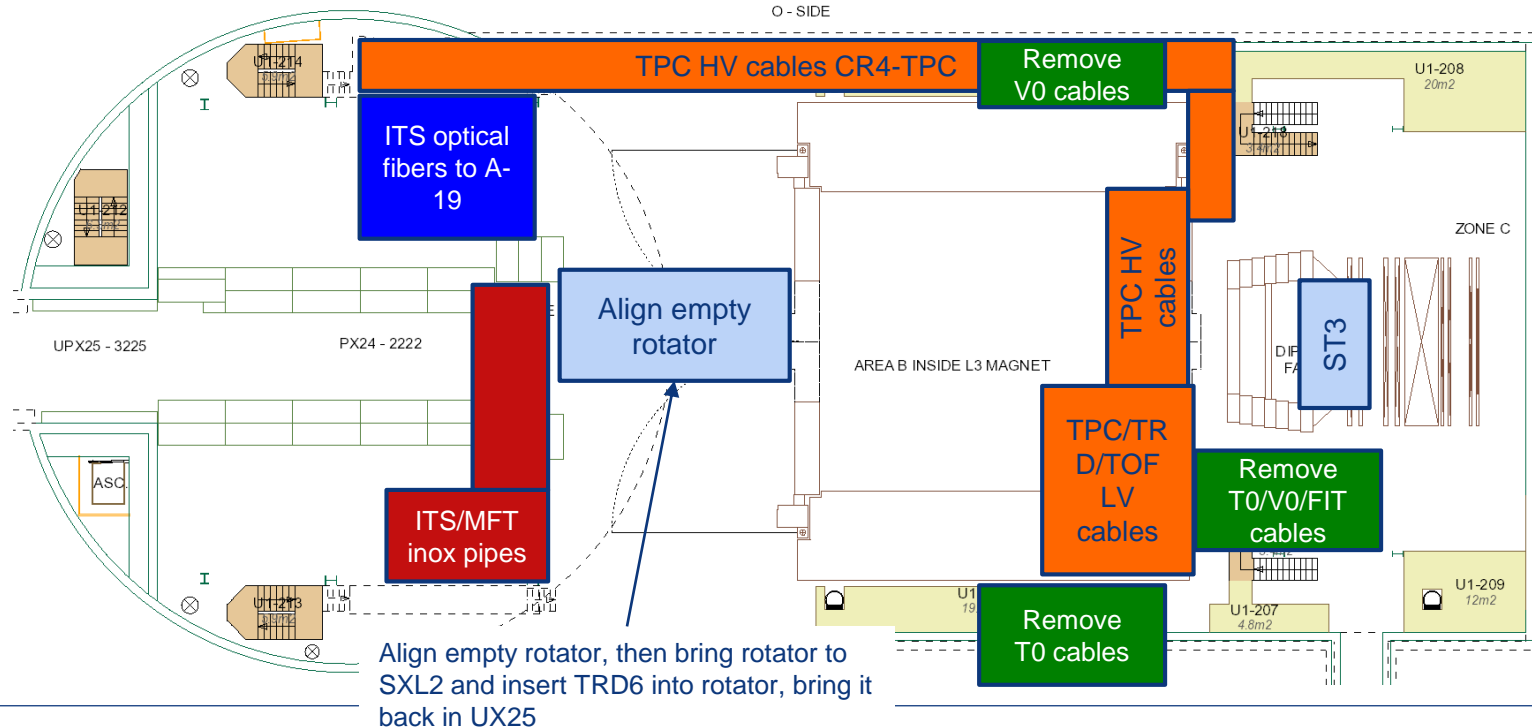

SXL2 activities w21 – Wed 22 May 2019

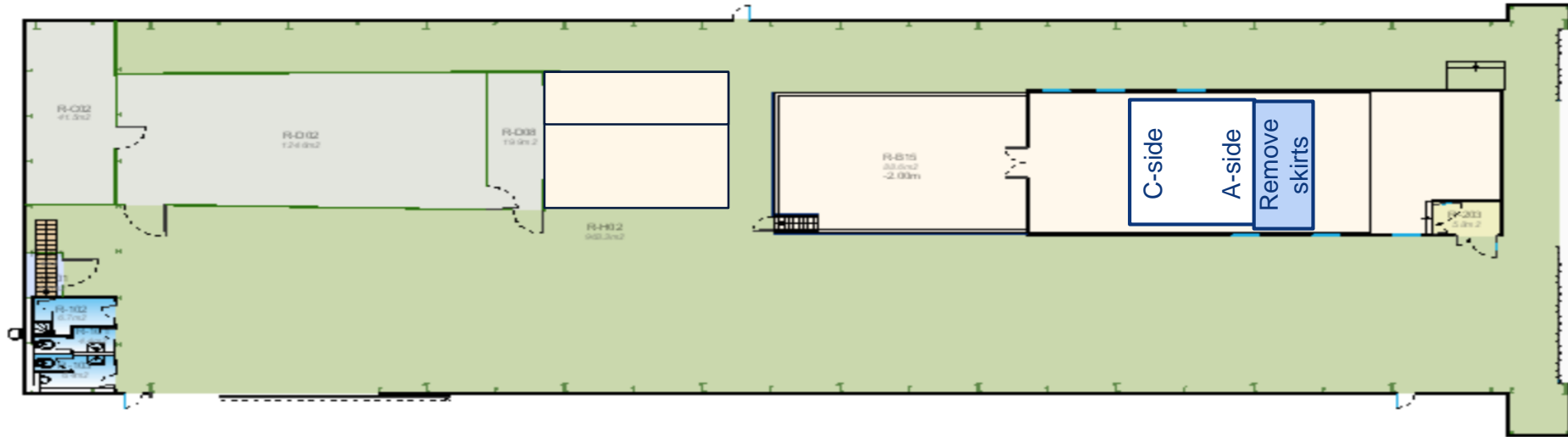

UX25 activities w21 – Thu 23 May 2019

Ouvaroff: install compensator magnet scaffolding (SX2)

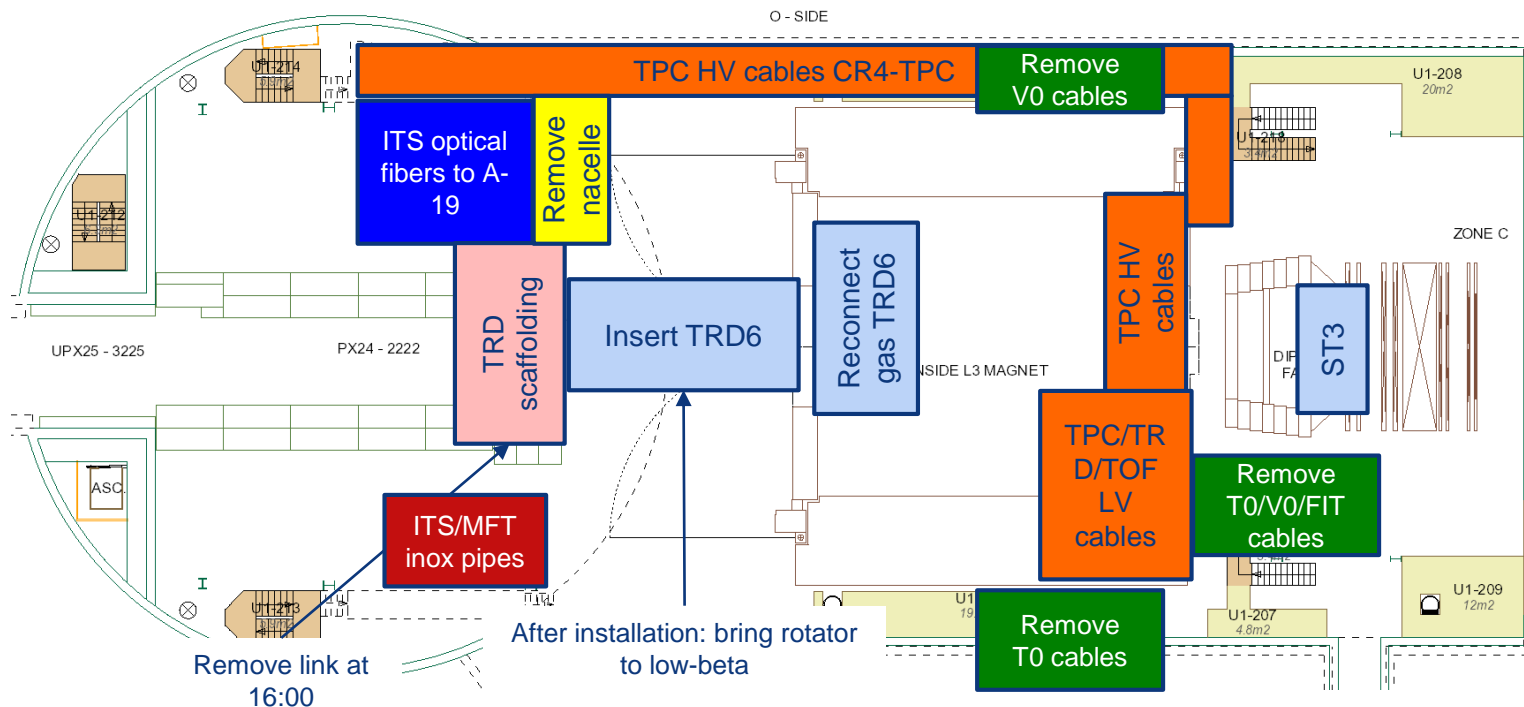

SXL2 activities w21 – Thu 23 May 2019

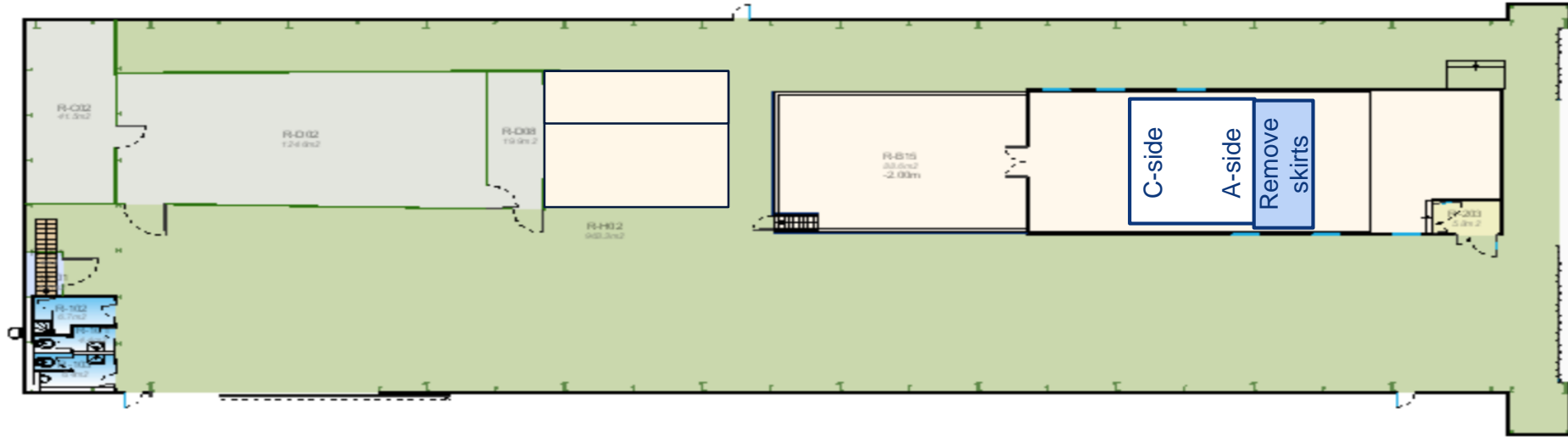

UX25 activities w21 – Fri 24 May 2019

Modify TRD table (SX2)

ALTEAD: transport inox pipes to UX25

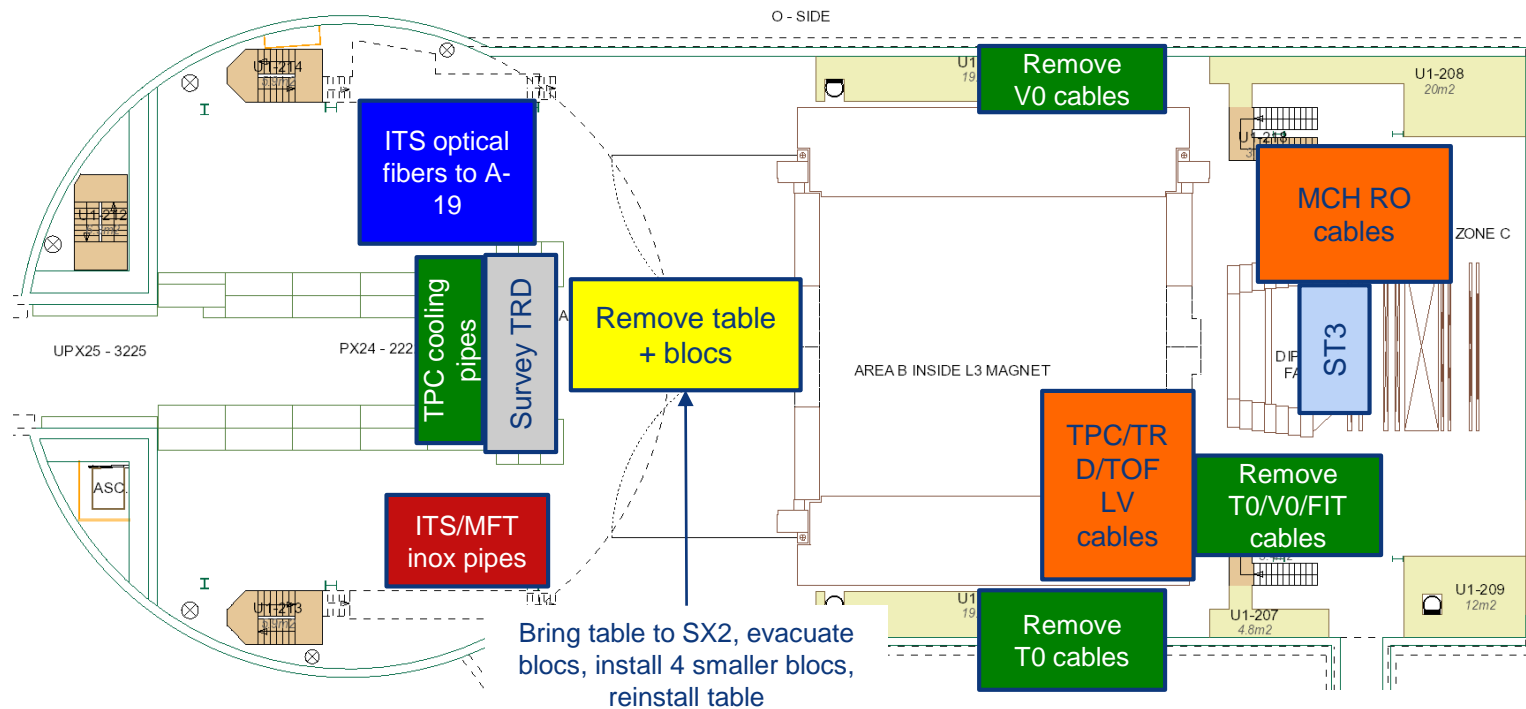

SXL2 activities w21 – Fri 24 May 2019

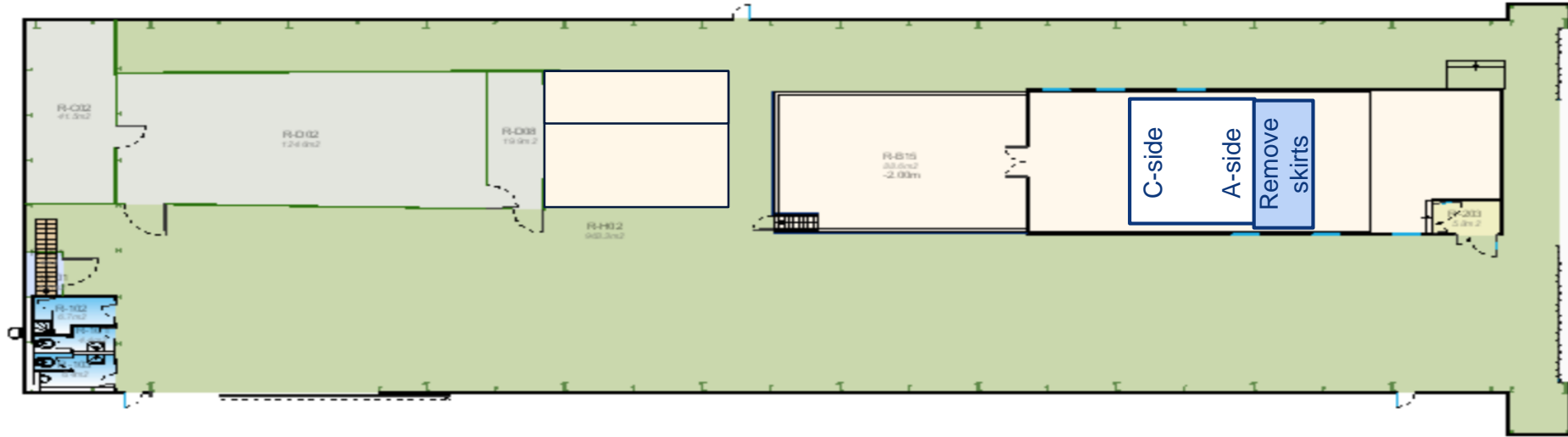

Day-by-day sequence w22

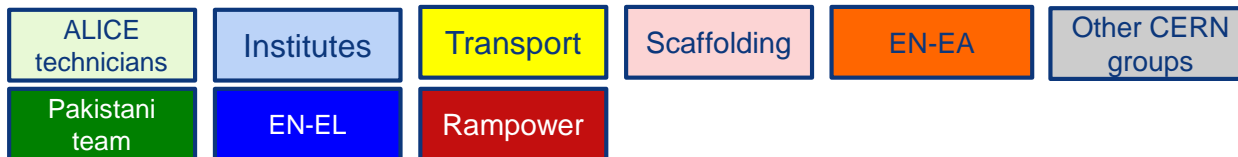

UX25 activities w22 – Mon 27 May 2019

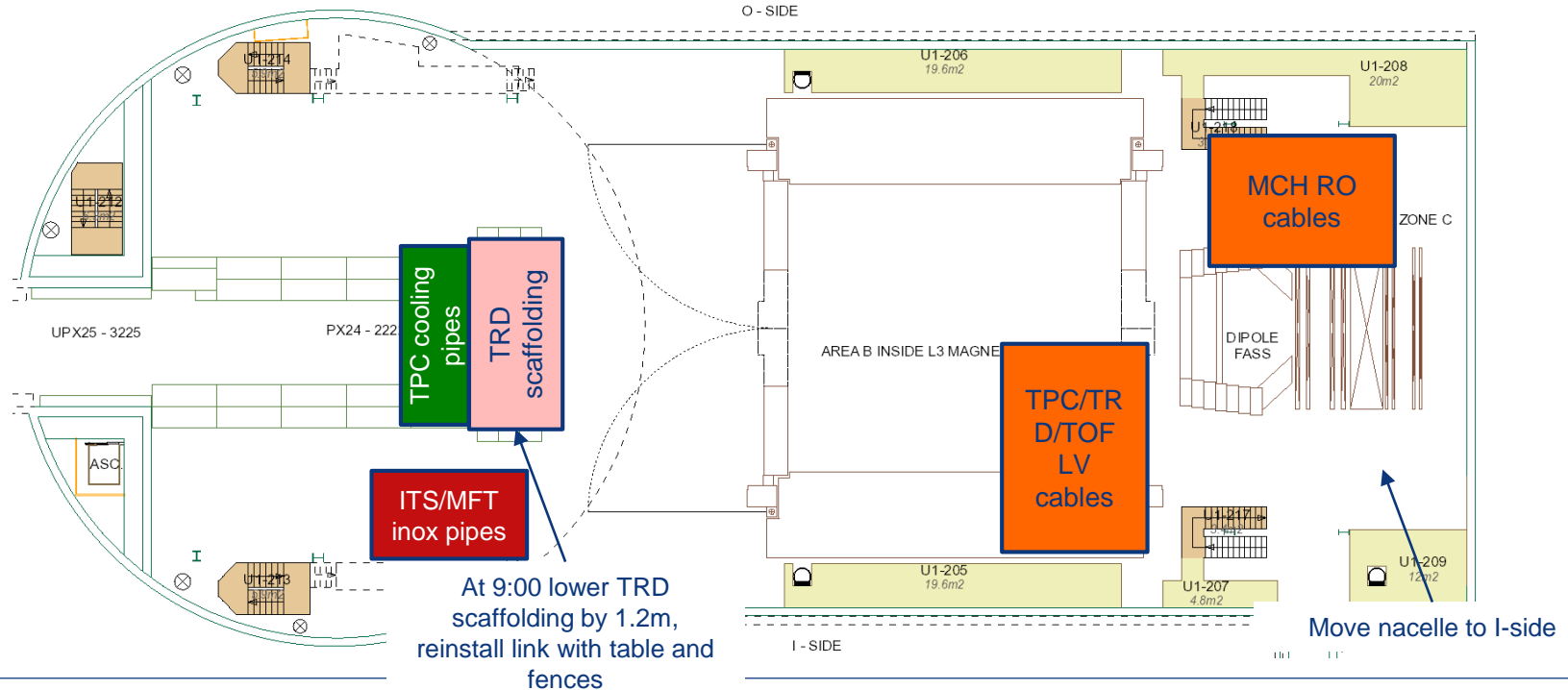

SXL2 activities w22 – Mon 27 May 2019

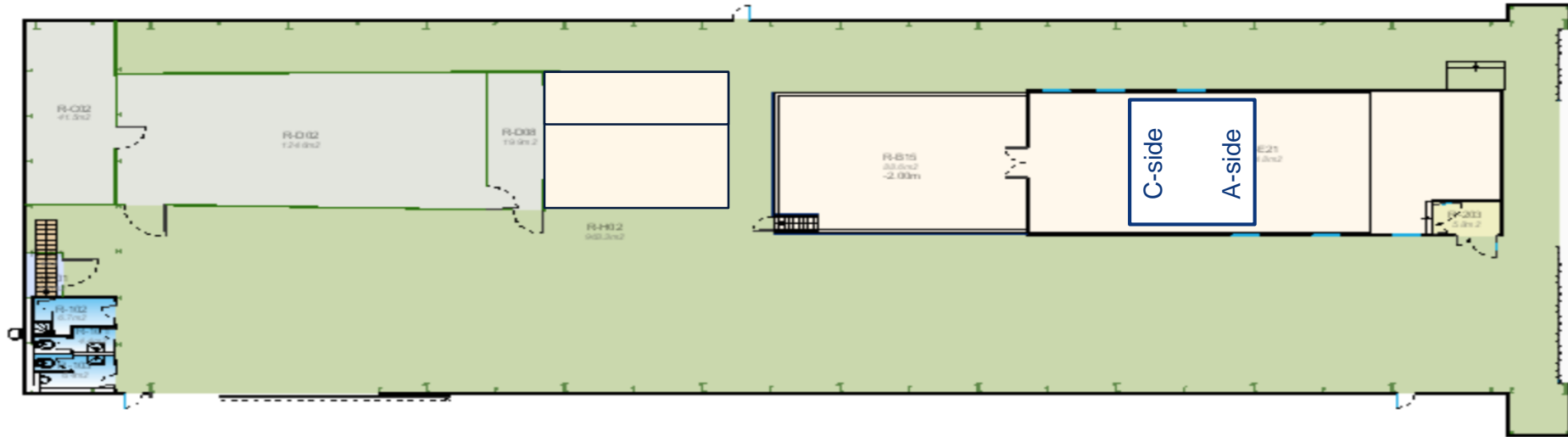

UX25 activities w22 – Tue 28 May 2019

Start 66kV maintenance: limited power CERN wide (no magnets)

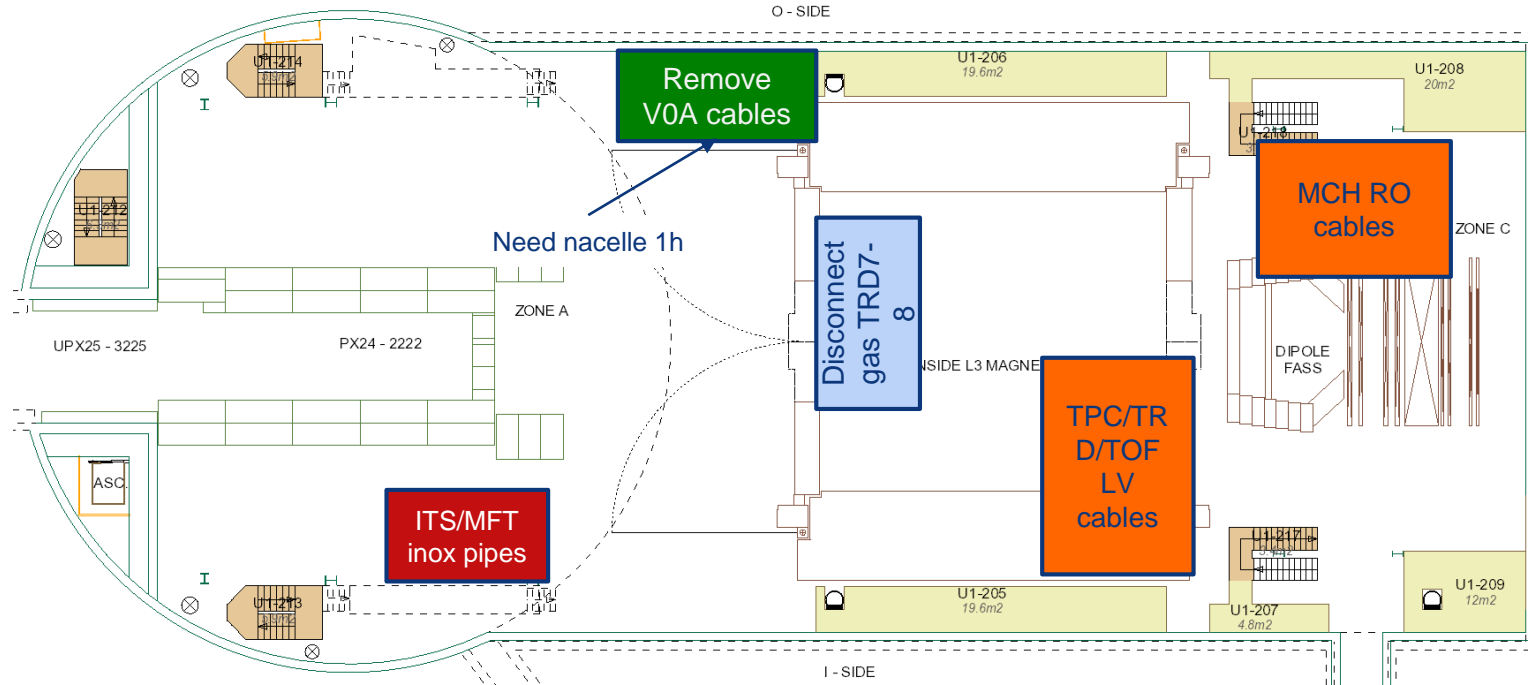

SXL2 activities w22 – Tue 28 May 2019

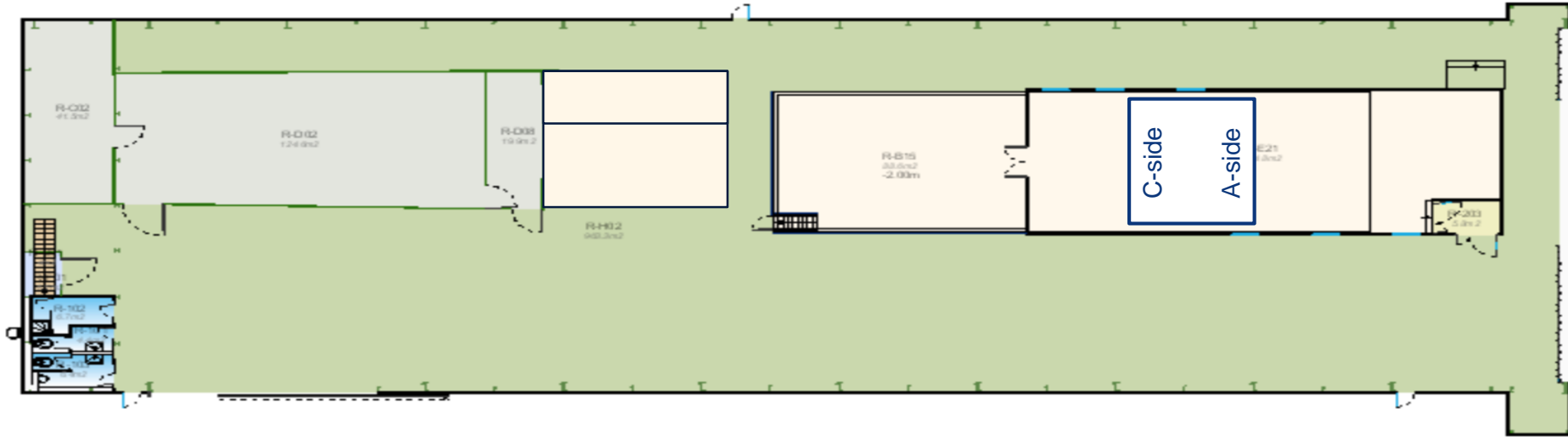

UX25 activities w22 – Wed 29 May 2019

ALTEAD + P2tech: load test beampipe support in SXL2

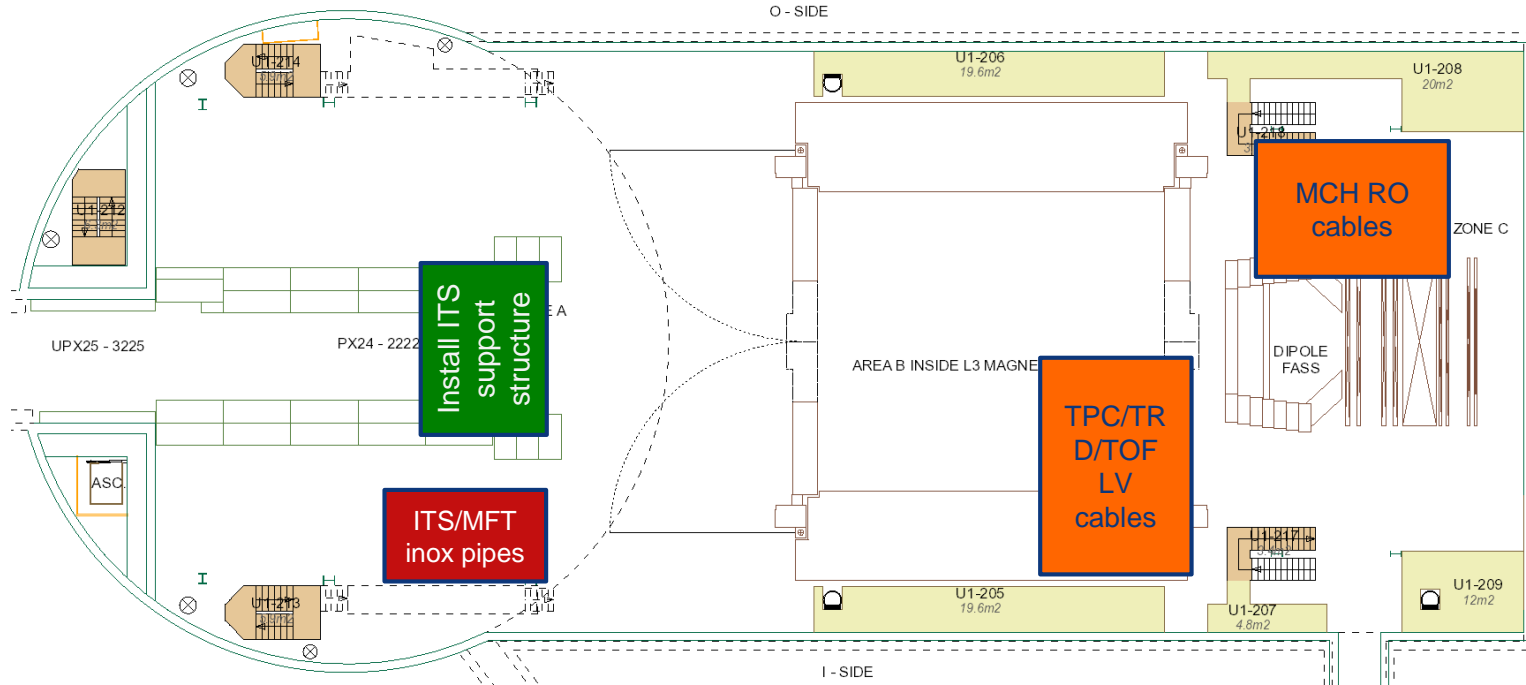

SXL2 activities w22 – Wed 29 May 2019

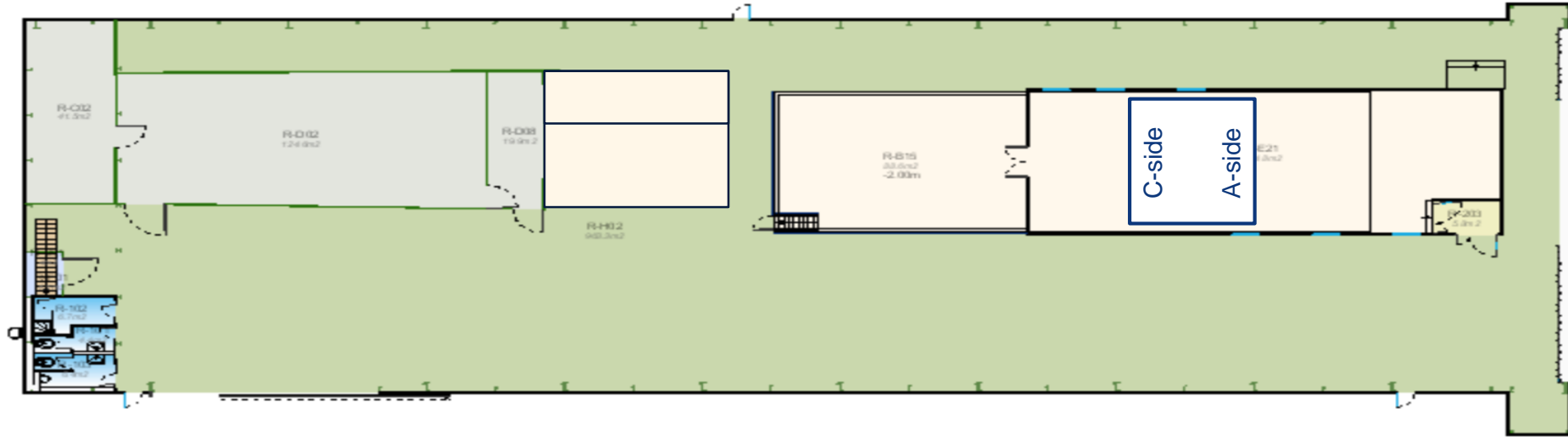

UX25 activities w22 – Thu 30 May 2019

CERN official holiday

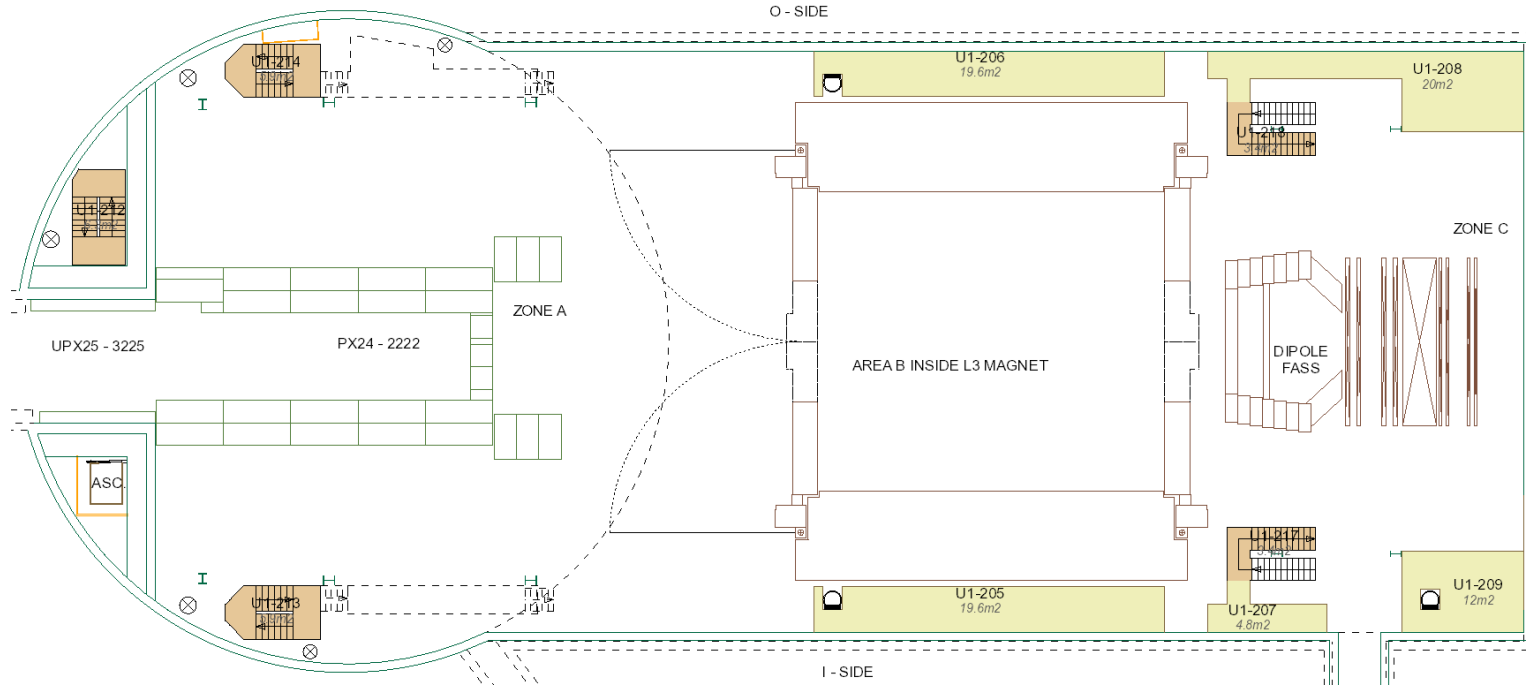

SXL2 activities w22 – Thu 30 May 2019

CERN official holiday

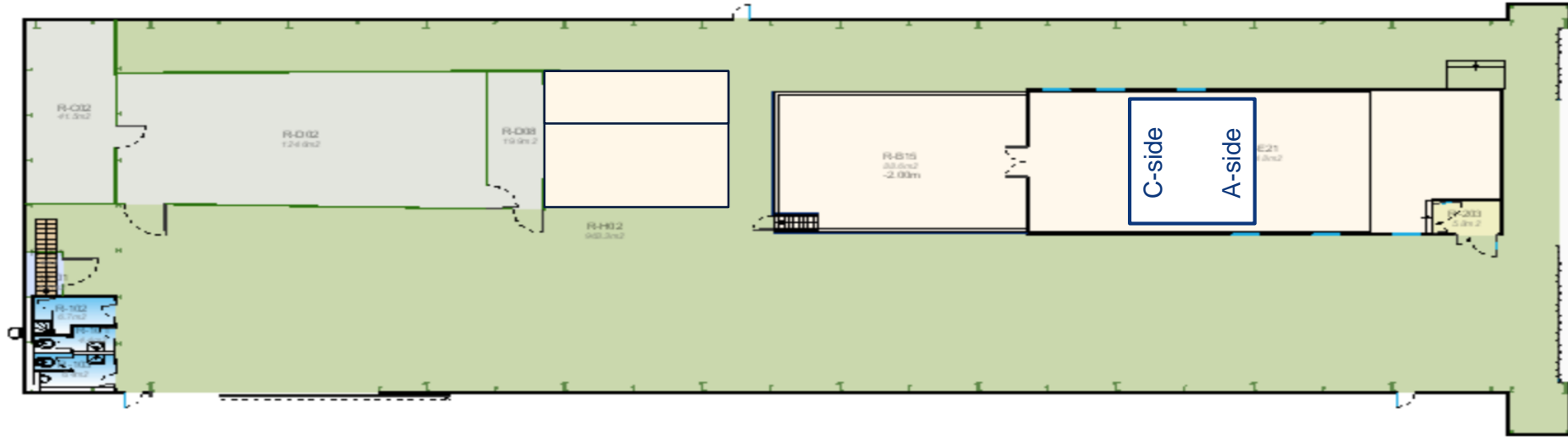

UX25 activities w22 – Fri 31 May 2019

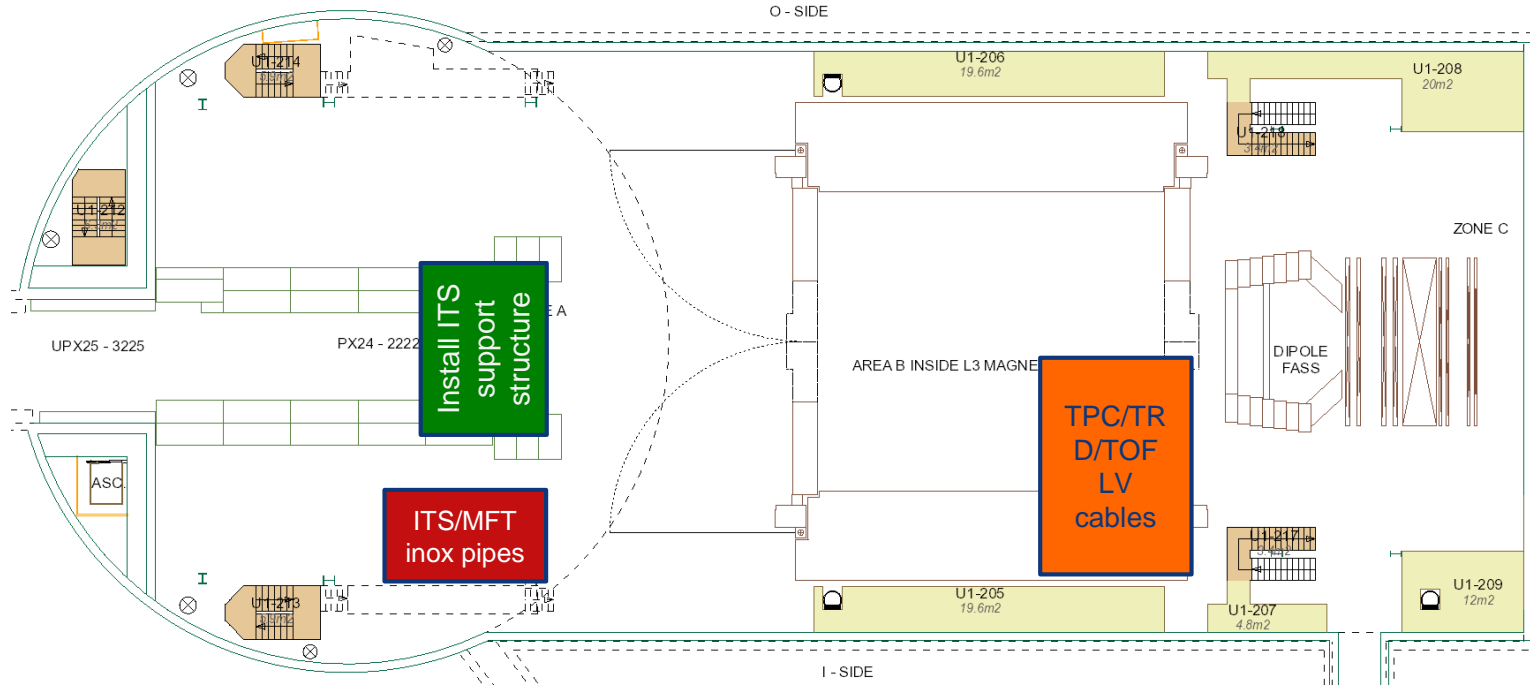

SXL2 activities w22 – Fri 31 May 2019

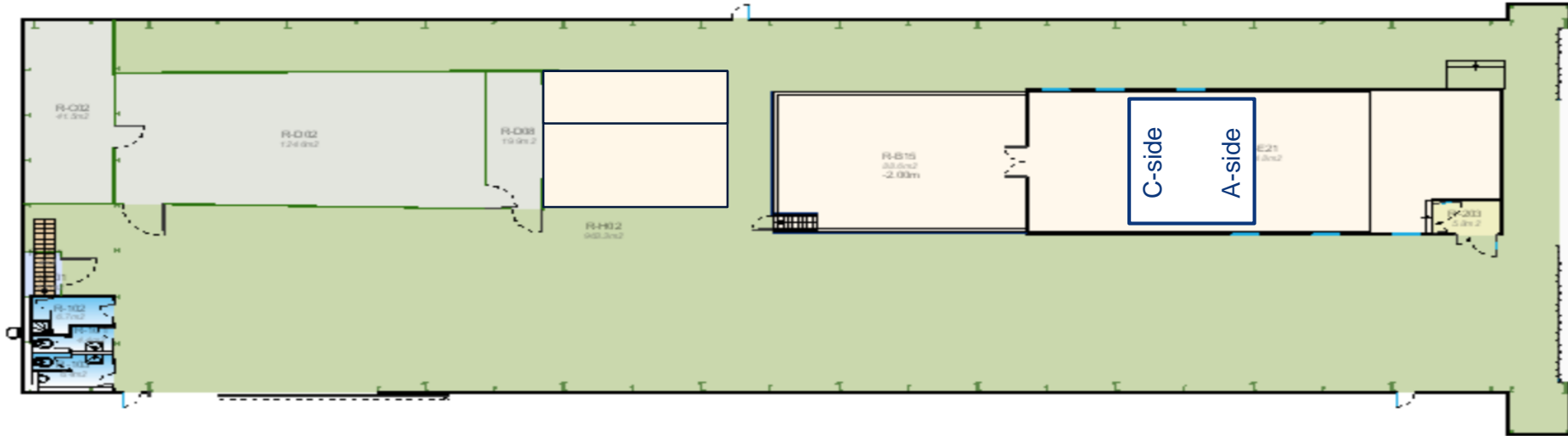

Day-by-day sequence w23

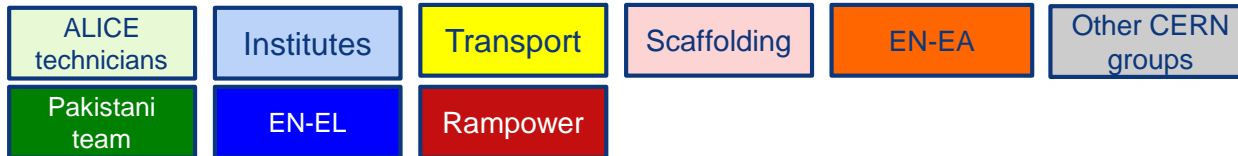

UX25 activities w23 – Mon 3 Jun 2019

X-ray tests ITS/MFT inox pipes – no access UX25 after 19:00 – Cavern closed

Ouvaroff: remove Miniframe front scaffolding + put PP1 bars (SX2)

ALTEAD: install block for beampipe support (Miniframe, SX2)

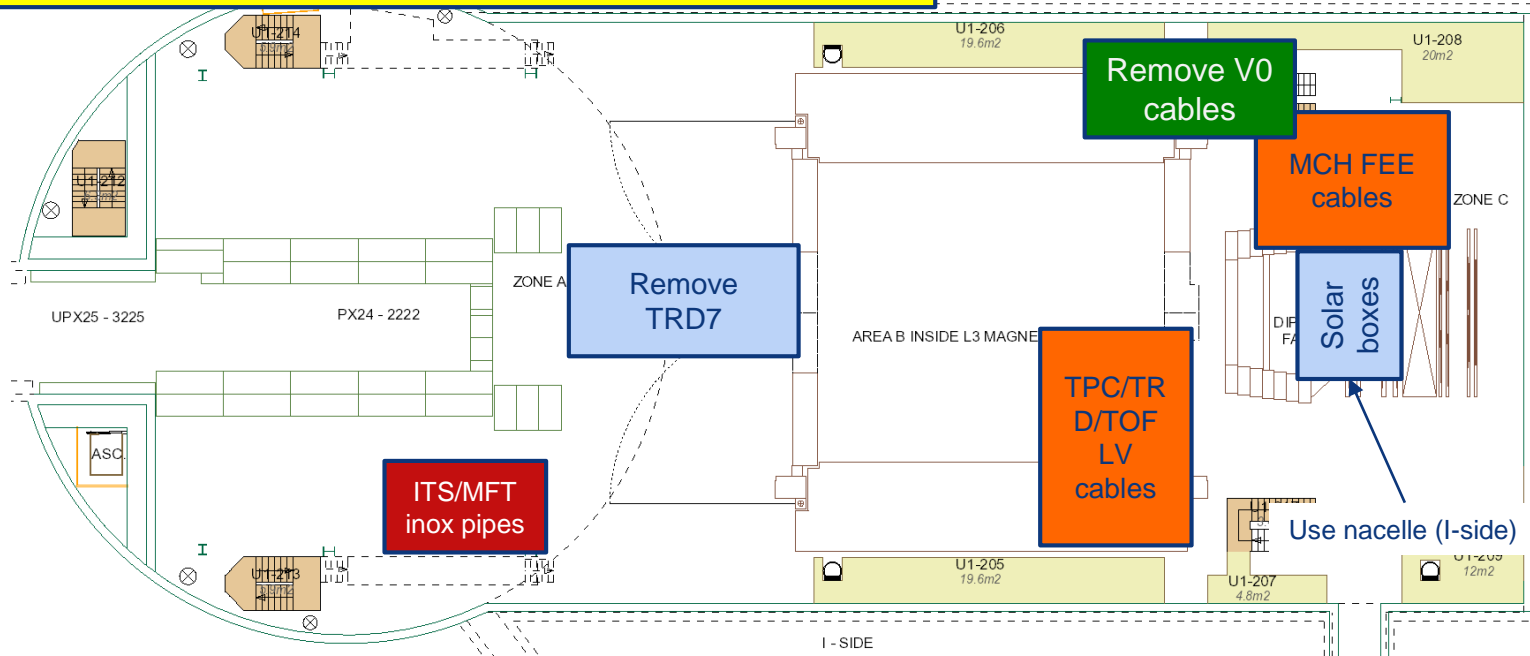

SXL2 activities w23 – Mon 3 Jun 2019

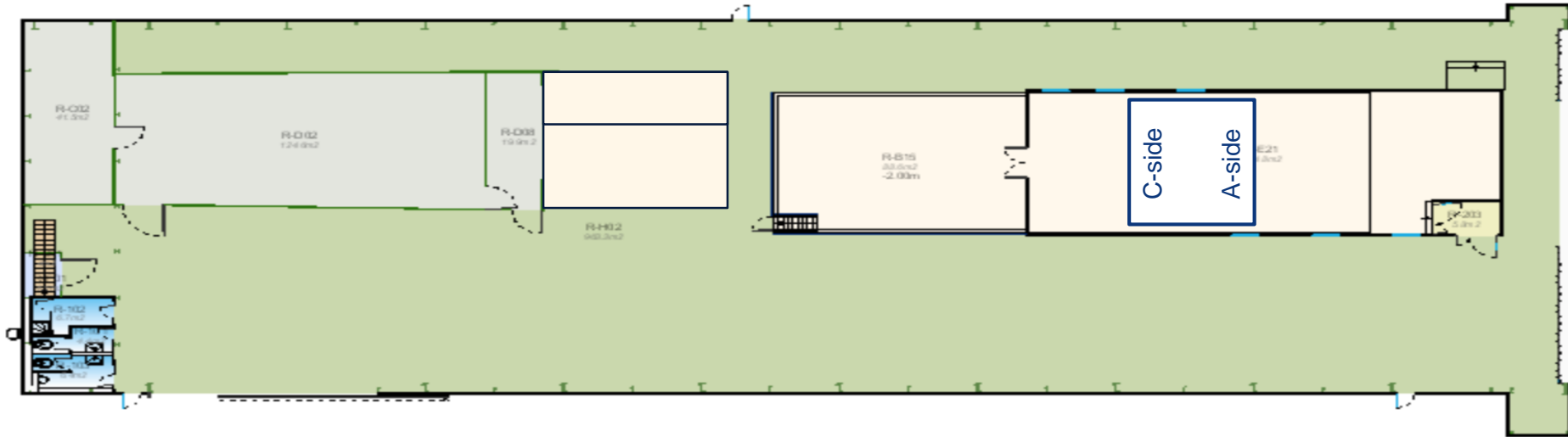

UX25 activities w23 – Tue 4 Jun 2019

Lift maintenance: no access underground between 6:00 AM and 8:00 AM

In SXL2: extract TRD7 from rotator and bring it in the swimming pool

Install PP0 mockup (SX2)

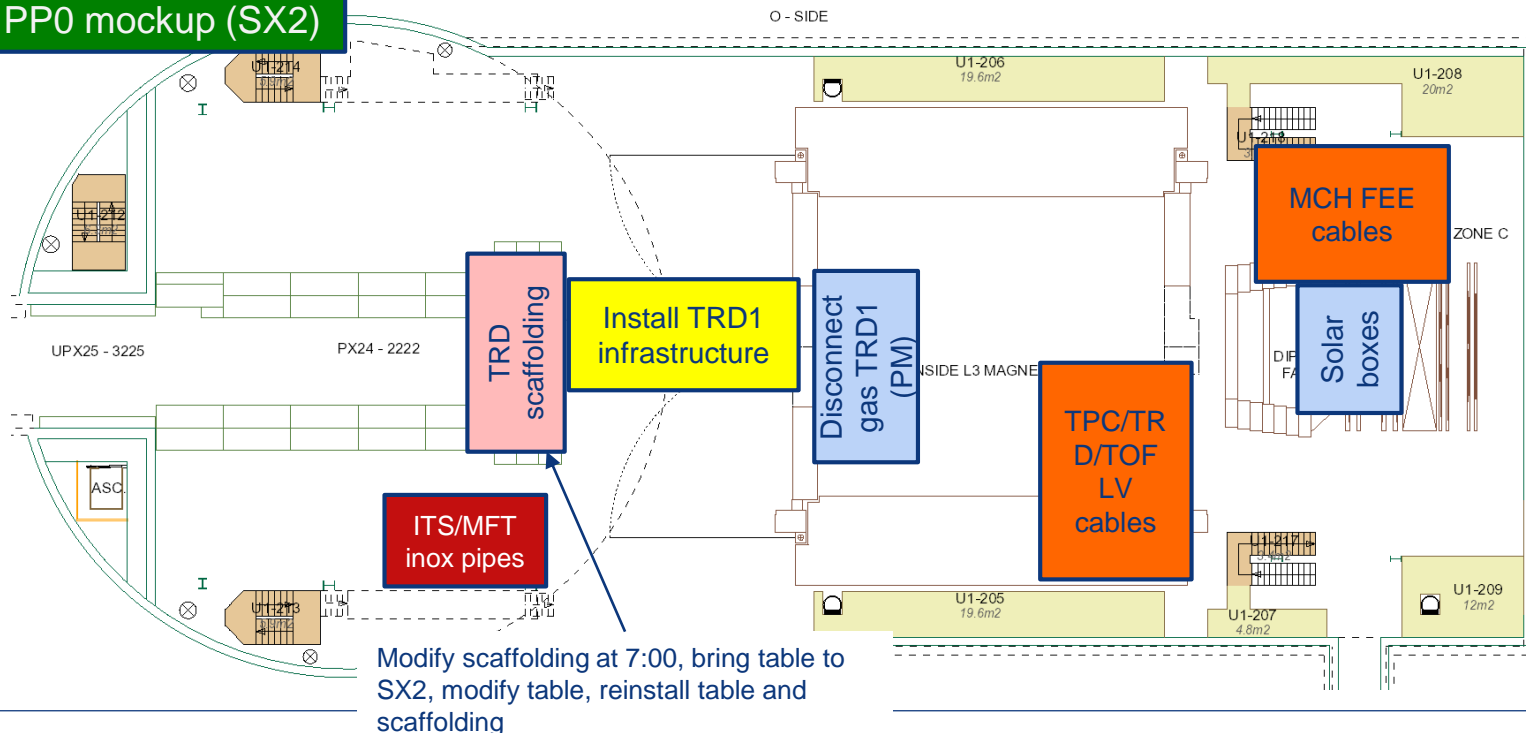

SXL2 activities w23 – Tue 4 Jun 2019

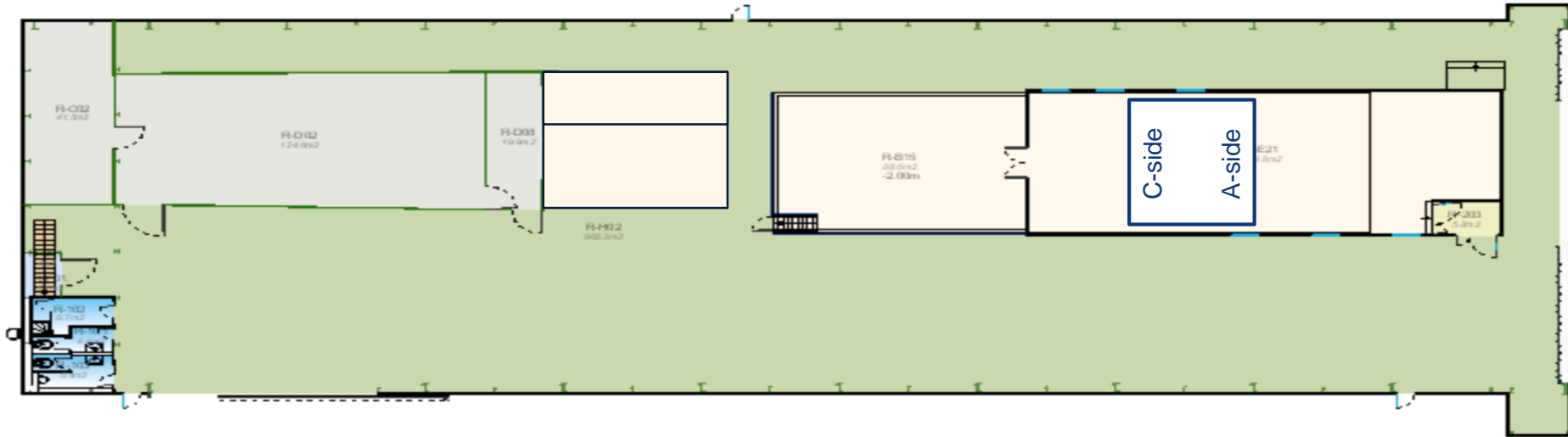

UX25 activities w23 – Wed 5 Jun 2019

Install PP0 mockup (SX2)

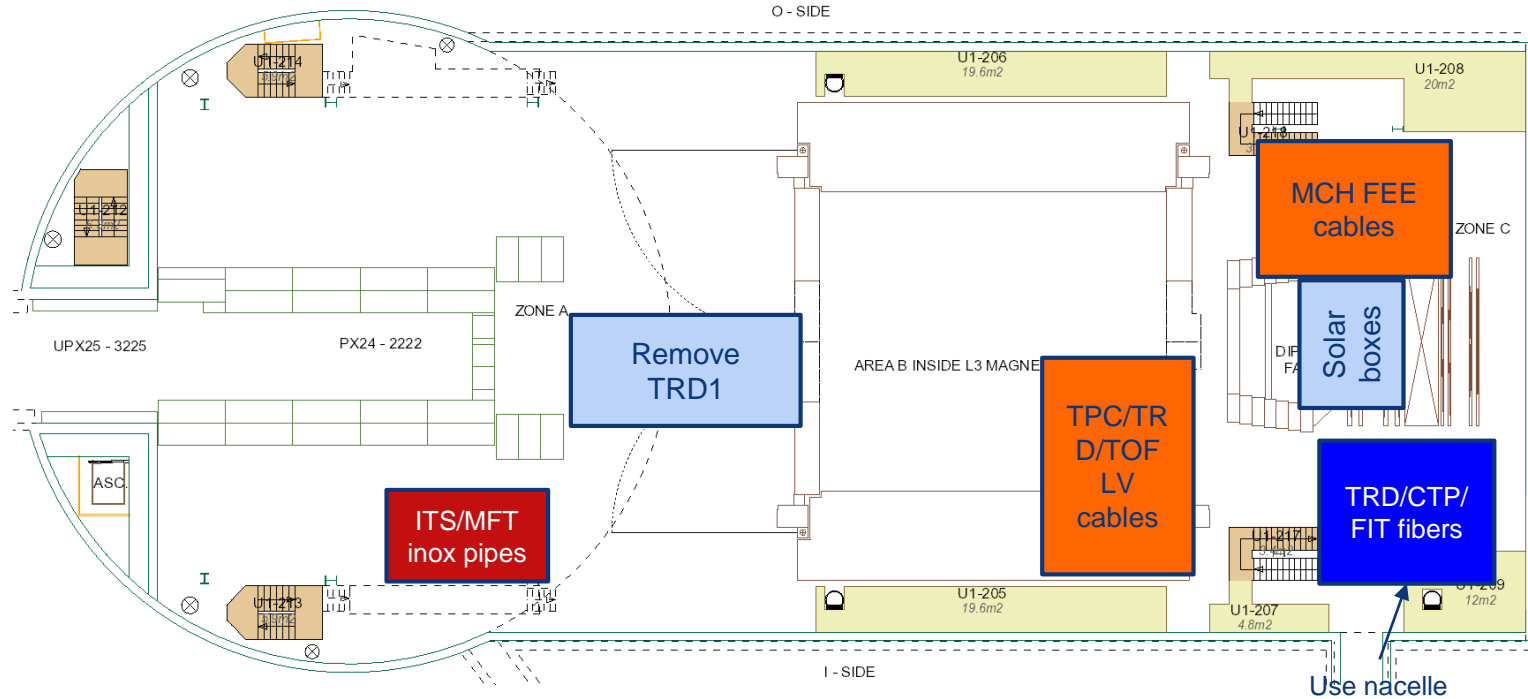

SXL2 activities w23 – Wed 5 Jun 2019

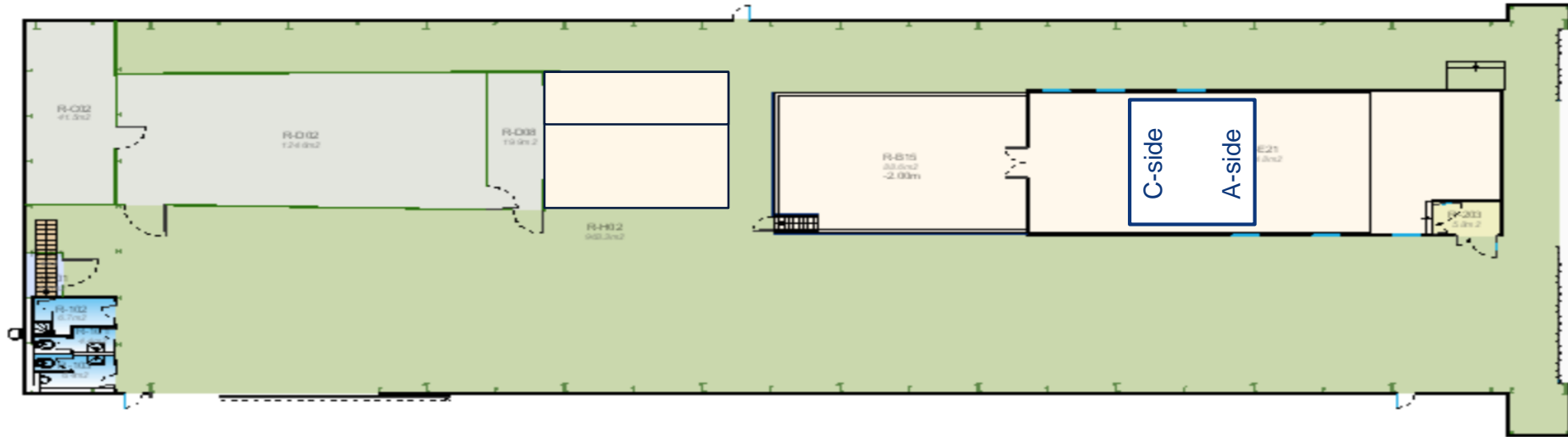

UX25 activities w23 – Thu 6 Jun 2019

Install new cable trays Miniframe

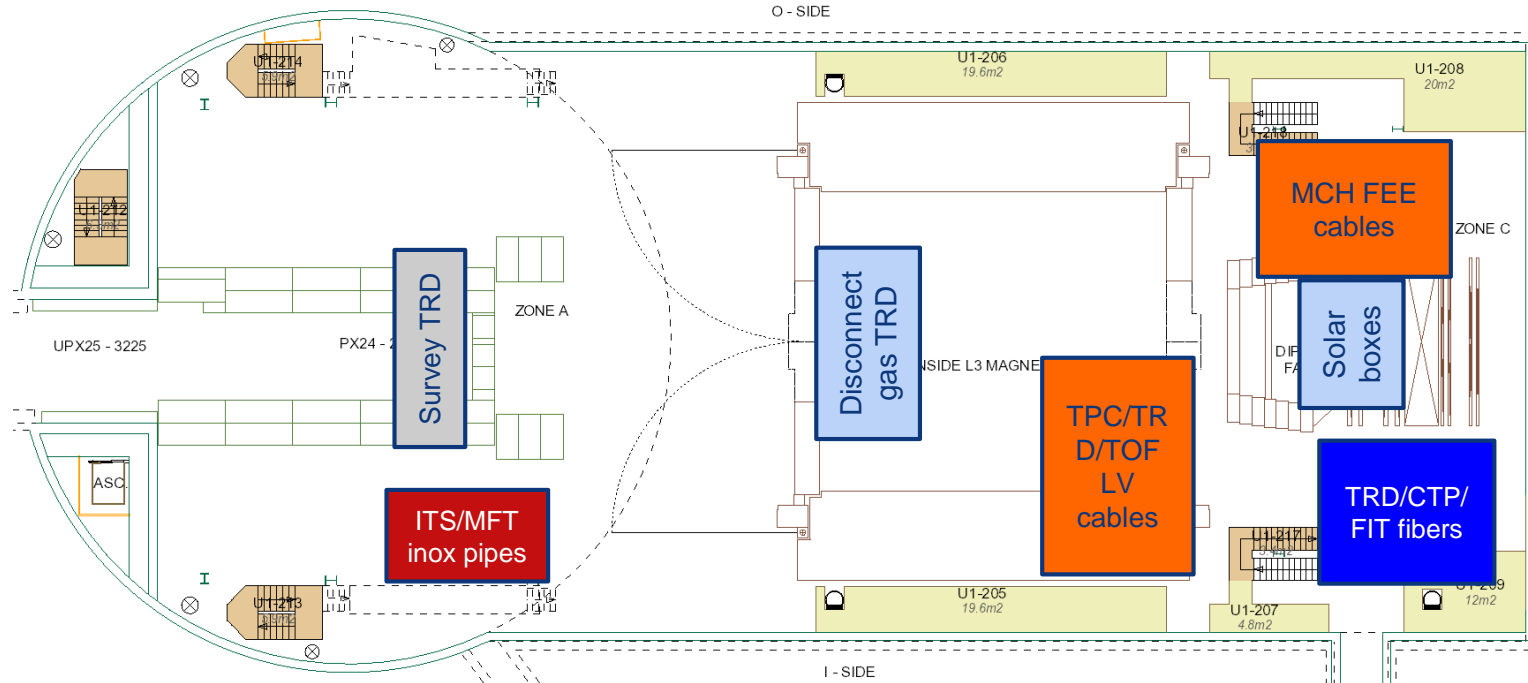

SXL2 activities w23 – Thu 6 Jun 2019

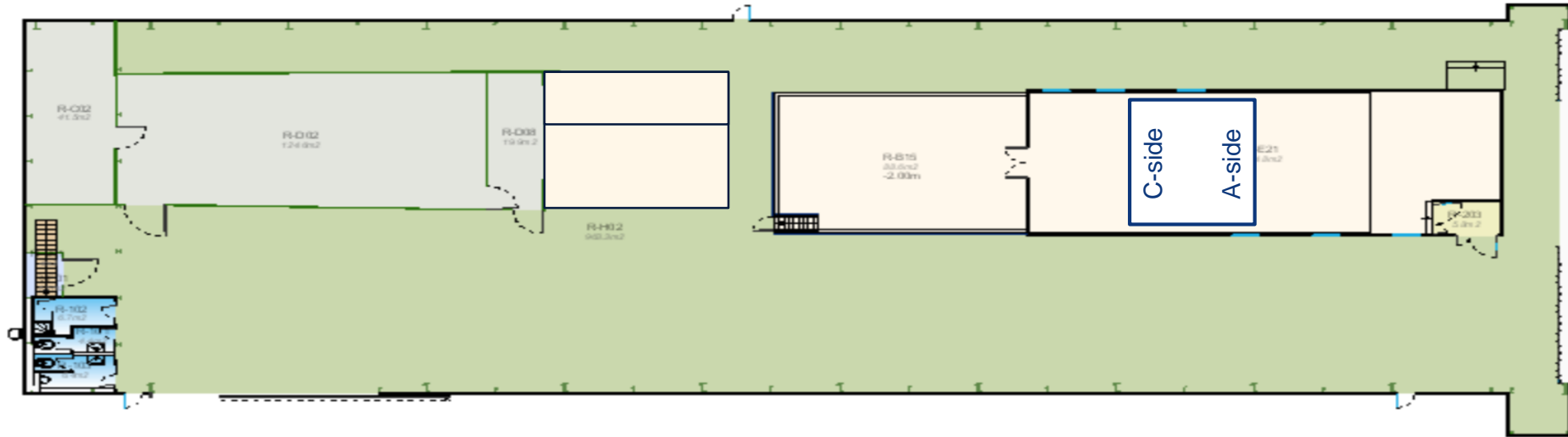

UX25 activities w23 – Fri 7 Jun 2019

Install new cable trays Miniframe

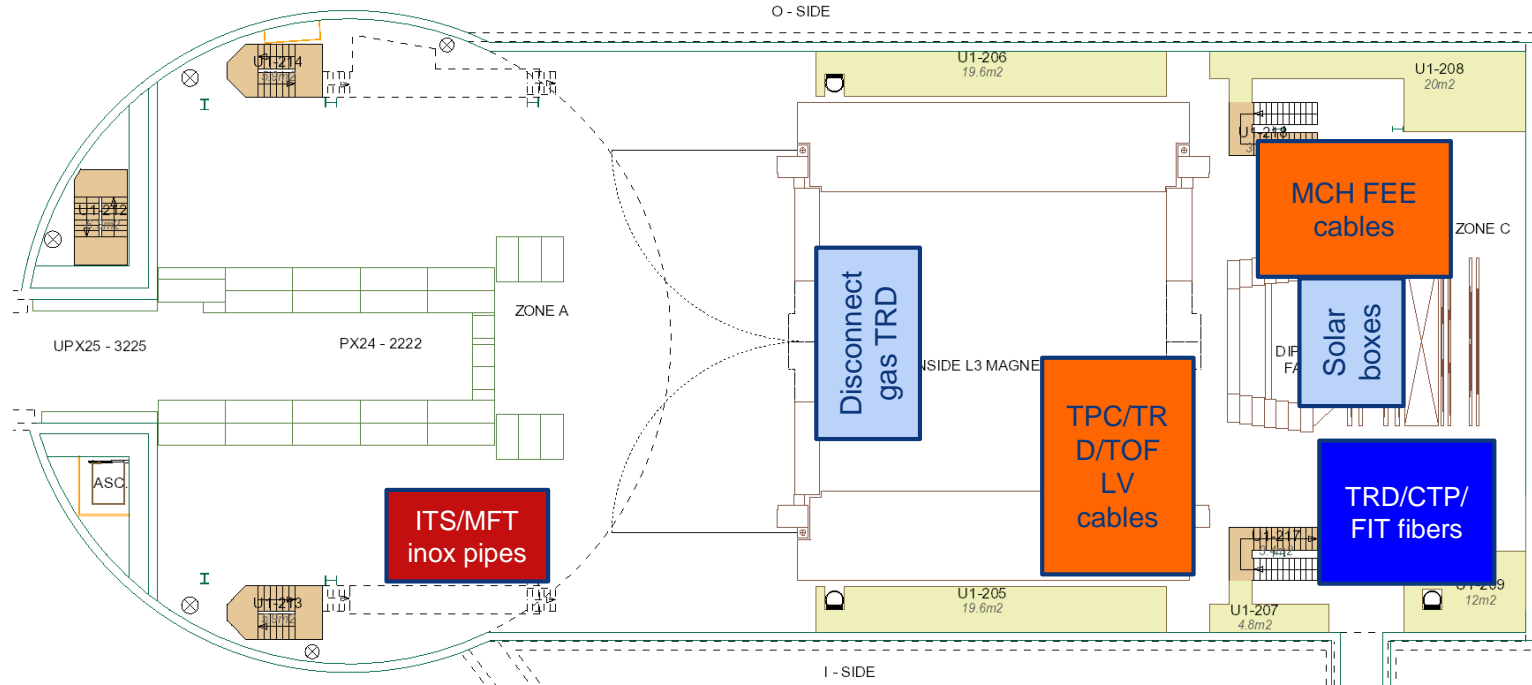

SXL2 activities w23 – Fri 7 Jun 2019

