

LS2 planning meeting

A.Tauro



LS2 master plan (v31)



Begin date	End date	Dur...
3/12/18	21/12/18	15
24/12/18	5/3/19	52
6/3/19	18/2/20	250
7/1/19	20/12/19	250
7/3/19	29/3/19	17
8/4/19	15/10/19	137
28/10/19	6/12/19	30
9/12/19	20/12/19	10
19/2/20	1/5/20	53
4/5/20	12/6/20	30
15/6/20	4/9/20	60
7/9/20	11/9/20	5
14/9/20	6/11/20	40
9/11/20	19/2/21	75

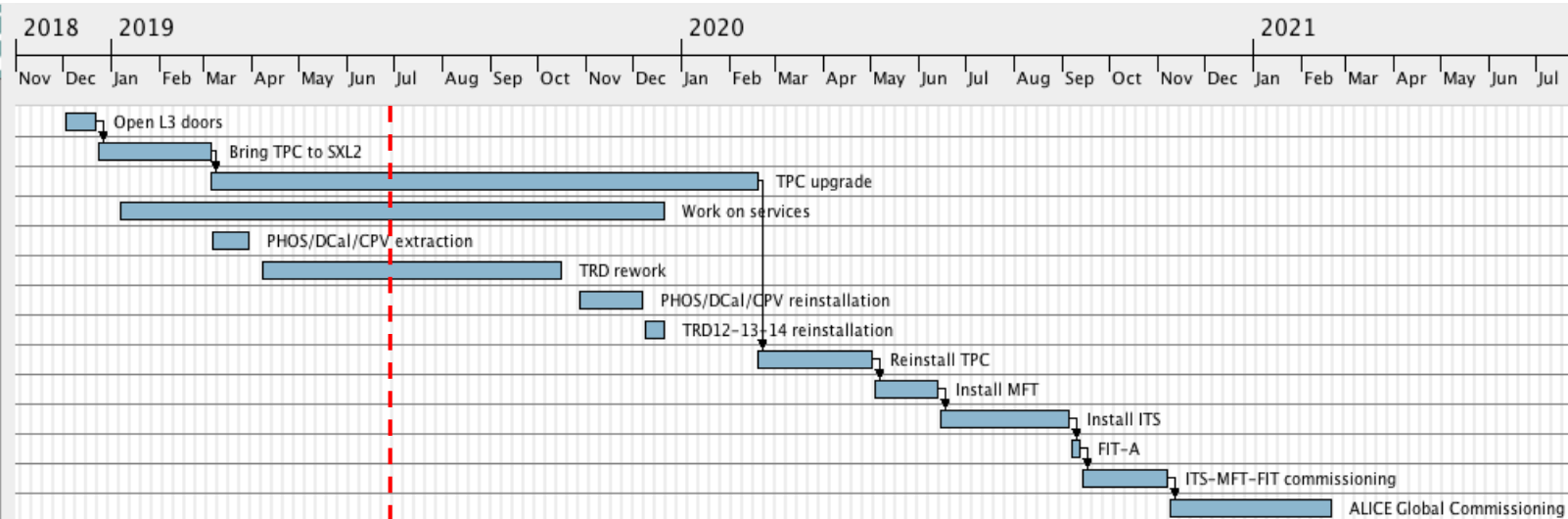

EN-EL interventions

- CERN wide 66kV maintenance: 28 May 2019 to 19 July 2019 – reduced consumption (i.e. no magnets) – almost done
- Maintenance machine network: from 11 to 14 June 2019 – done
- Test secours (10 min): 19 Dec 2019 from 8:00 AM to 11:00 AM
- 18kV, 3.3kV and LV network maintenance:
 - Mon 20 to Wed 22 Jan 2020: 3 days no general services - no access on site (both surface and underground)
 - Thu 23 to Fri 24 Jan 2020: 2 days “Limited access” → details being worked out
- AUG on Monday 27 January 2020 - no access on site (both surface and underground)
- Auto transfer test: 27-29 Apr 2020
- BIW test: 5 and 6 Oct 2020 from 18:00 to 00:00 – no access underground

EN-CV interventions

- **Big maintenance:**

- SF: from Nov 2019 to mid Jan 2020. NO impact on ALICE as both magnets will be OFF.
- UW: **stop UX mixed water** for 2 days in week 40/2019 (October).
- SU: various small perturbations + 1 day **stop all cooling UX** + 1 day **stop all cooling SXL2** in week 16/2020 (April).

- **Small maintenance:**

- UW: from mid Aug 2020 to mid Sep 2020. **Stop mixed water UX** for 1 day in week 37/2020 (September).
- SF+SU: weeks 45-47/2020: cleaning towers (stop SF 1 week) + 1 day **stop all cooling UX**.

- **Ventilation:**

- SG2: w7/2019 - Done
- Gas extraction: w8/2019 - Done
- UX25 cavern: May 2020 (tbc)
- MCH and MTG: Apr 2020 (tbc)
- L3: Apr 2020 (tbc)
- ITS: Apr 2020 (tbc)

- **Raw water:**

- Test after Apr 2019. Short interruption (1 day), can be used tap water during the test.

UX access

- **Cavern lift not available from Friday 26 July 12:00 to Saturday 27 July 18:00**
 - no access to cavern
 - no underground visits

CERN Open Days

- Sat 14 and Sun 15 September 2019
- Open Low-Beta platform and put scaffolding

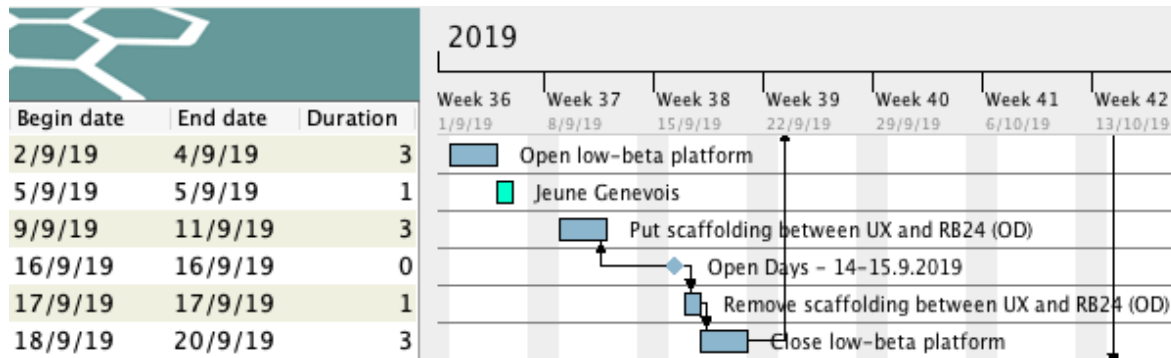

TPC upgrade sequence v34

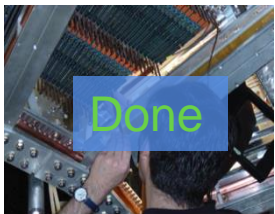

Remove Services and FEE
(outside cleanroom)



Uninstall MWPC ROC



Install GEM ROC

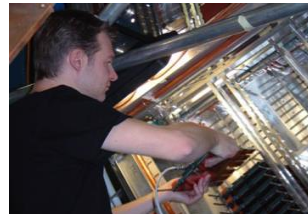

Install new FEC + test



Transportation to SX2



TPC in cleanroom.
Cleaning & irradiation tests

7 Mar

11 Apr

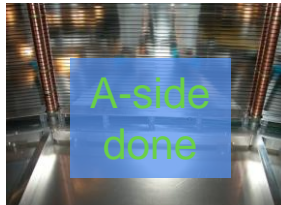

FC HV infrastructure
modification

25 Apr (A)
30 Jul (C)

27 May (A)
13 Aug (C)



Survey, sealing,
overpressure test

17 Jun (A)
21 Aug (C)

2 Jul (A)
4 Sep (C)



Pre-commissioning with
cosmic, Laser, pulser, Xray

2 Oct (A)
23 Oct (C)

31 Oct (A)
4 Dec (C)
21 Jan (Xray)

18 Feb 2020

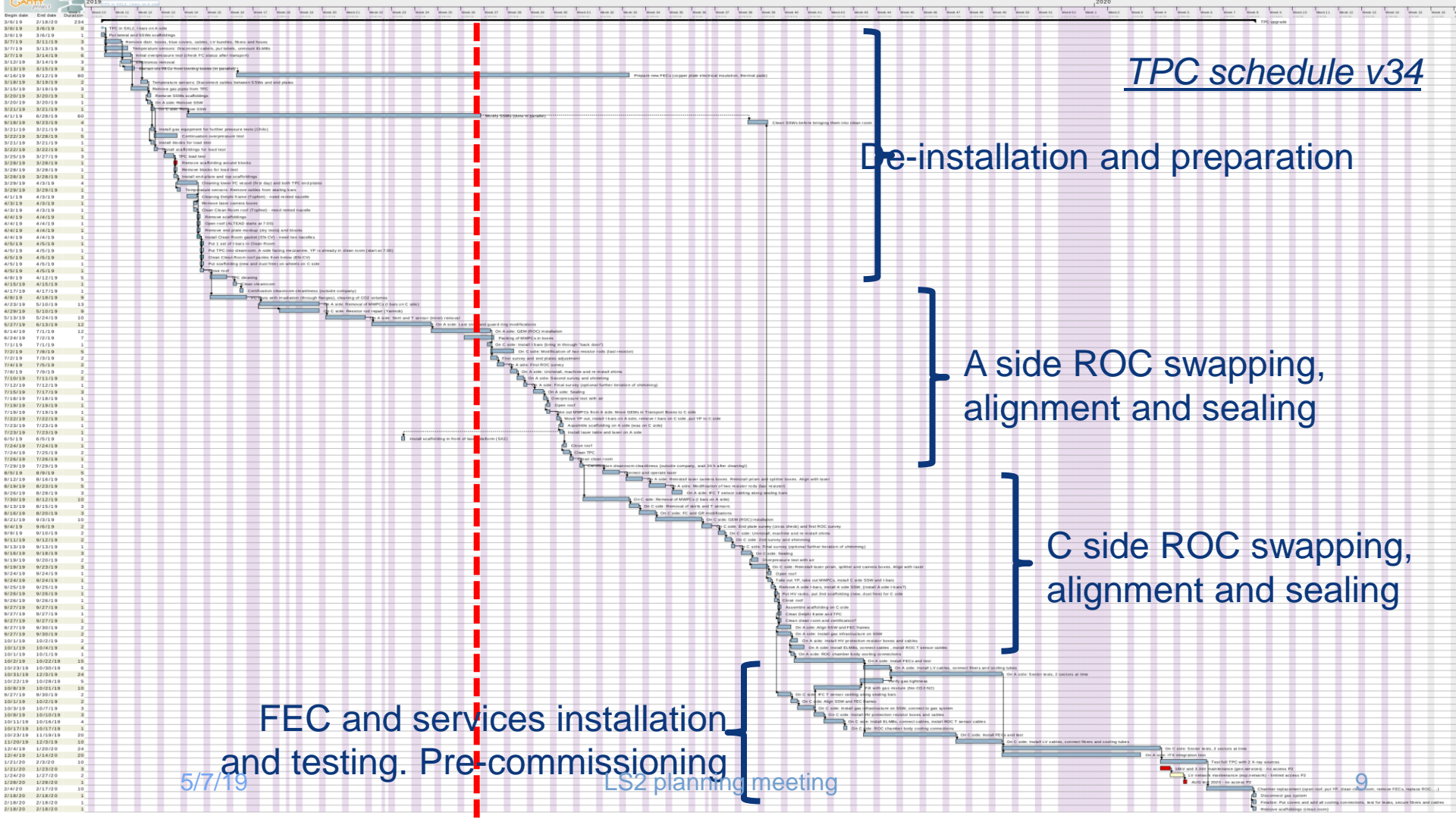

TPC schedule v34

Pre-installation and preparation

A side ROC swapping, alignment and sealing

C side ROC swapping, alignment and sealing

FEC and services installation and testing. Pre-commissioning

5/7/19

LS2 planning meeting

9

Copper cables (EN-EA) – new dates

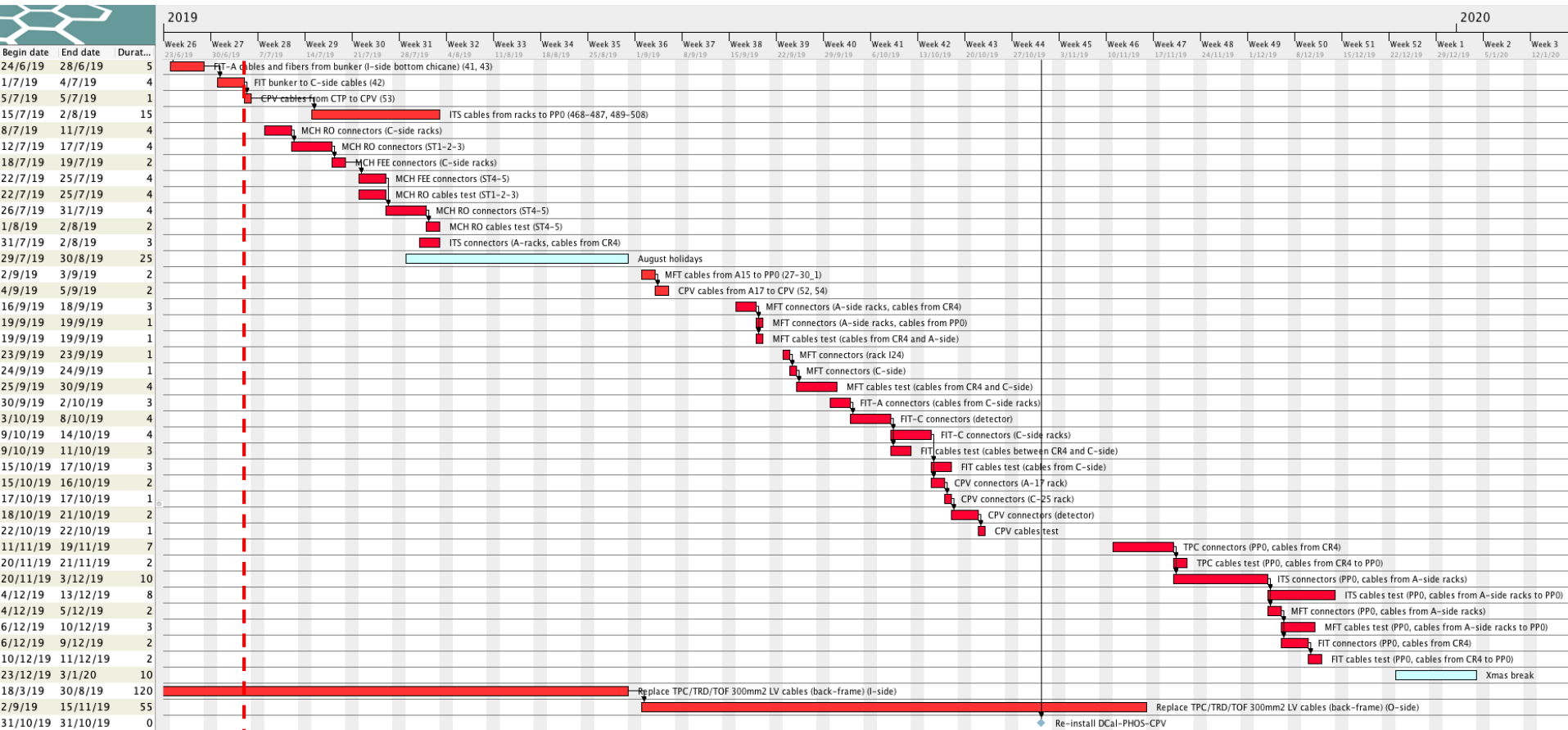

5/7/19

LS2 planning meeting

10

Copper cables (EN-EA) – progress

ALICE LS2 - EN-EA cabling control follow-up 05-07-2019

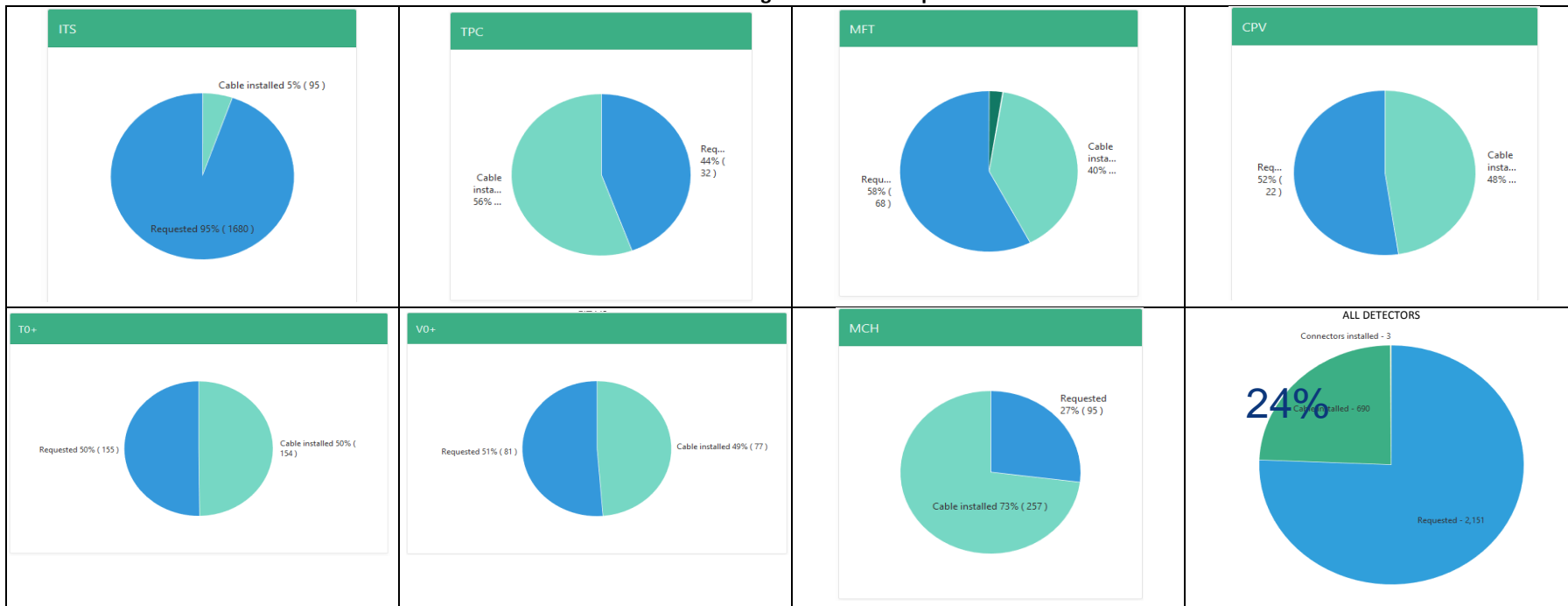

Optical fibers (EN-EL) – new dates

Begin date	End date
30/9/19	2/10/19
3/10/19	16/10/19
23/12/19	3/1/20
28/1/20	27/3/20
8/4/20	8/4/20
24/4/20	24/4/20
4/5/20	15/5/20
18/5/20	20/5/20

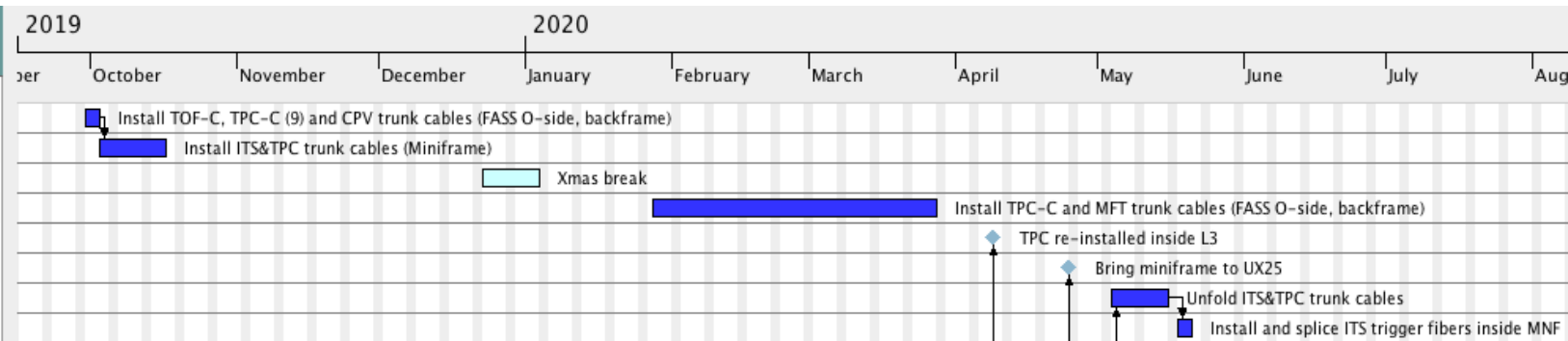

Miniframe planning – new dates

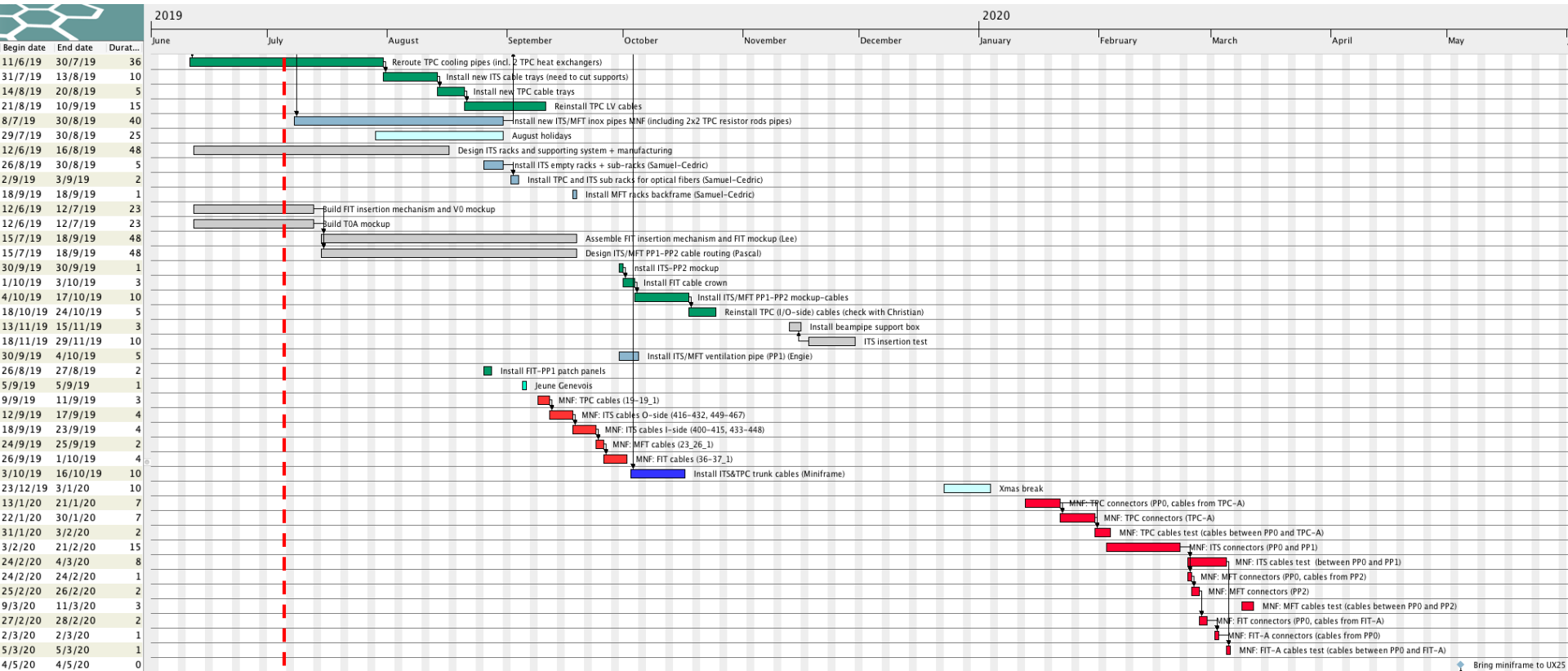

Bring miniframe to U2S

CR0 planning

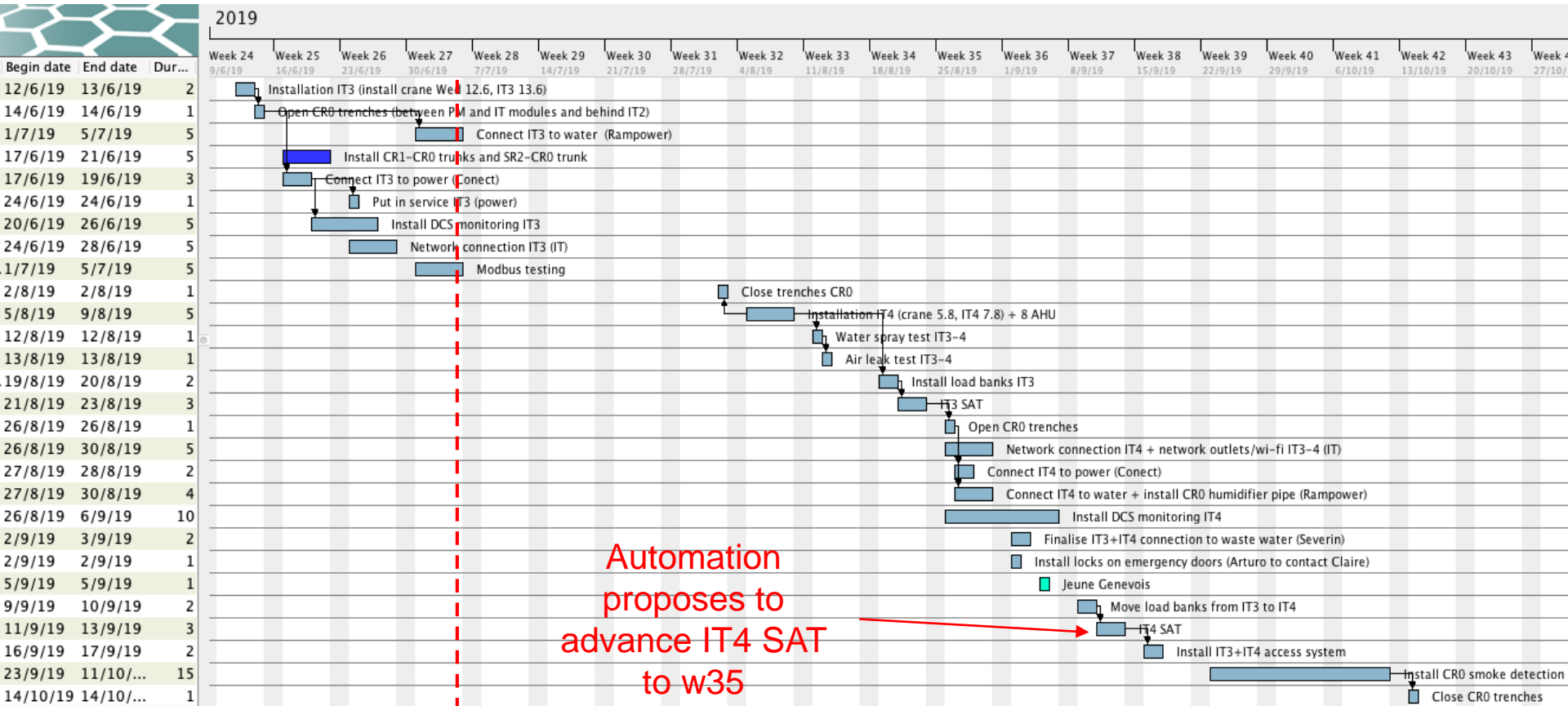

Automation
proposes to
advance IT4 SAT
to w35

LS2 planning meeting

Day-by-day sequence w25

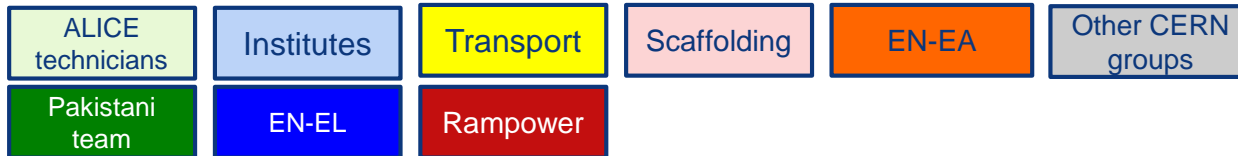

UX25 activities w25 – Mon 17 Jun 2019

CR0: install CR1-CR0 trunks and SR2-CR0 trunk – whole week (COMSA)

CR0: connect IT3 to power (Conect)

Pressure test PHOS M2 (Meyrin, Yannick)

Install TPC cooling pipes Miniframe (whole week)

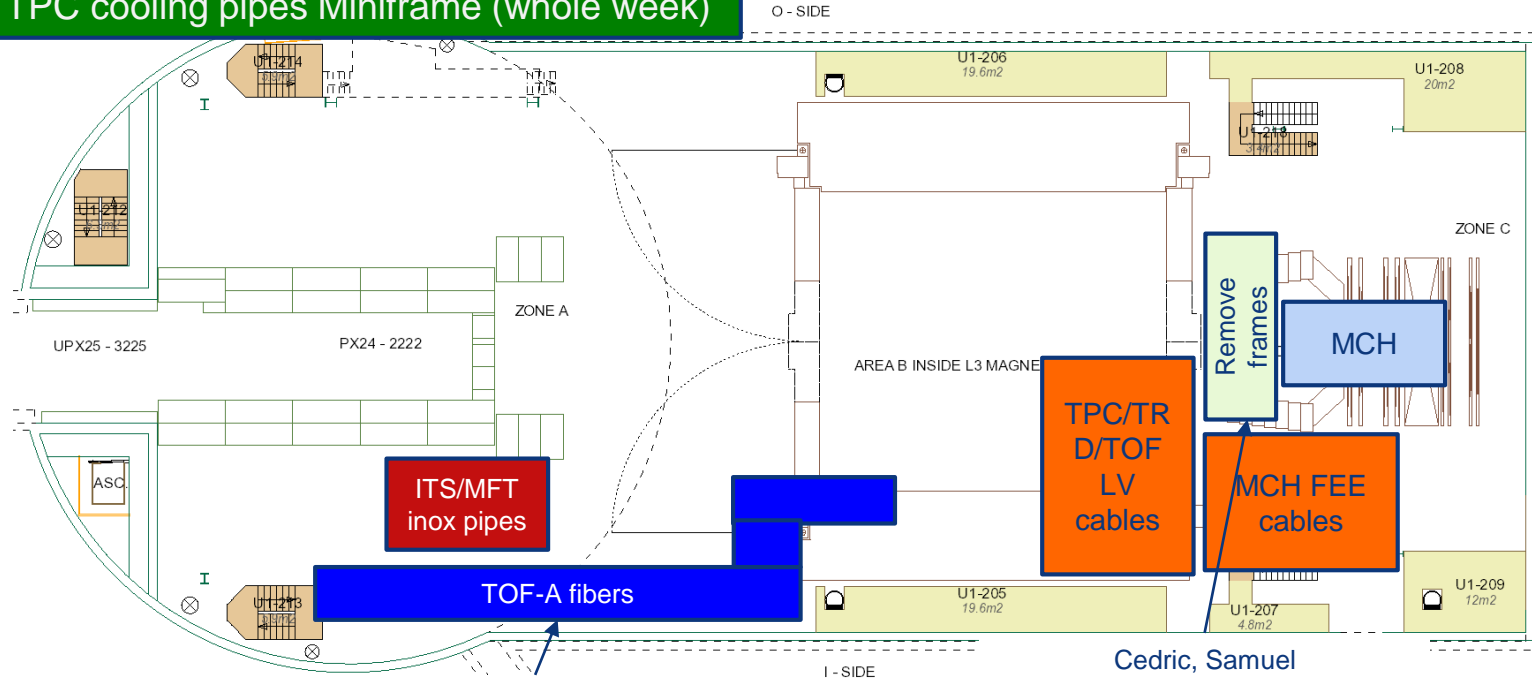

Need scaffolding of LV cables
+ ladder inside L3

ing meeting

SXL2 activities w25 – Mon 17 Jun 2019

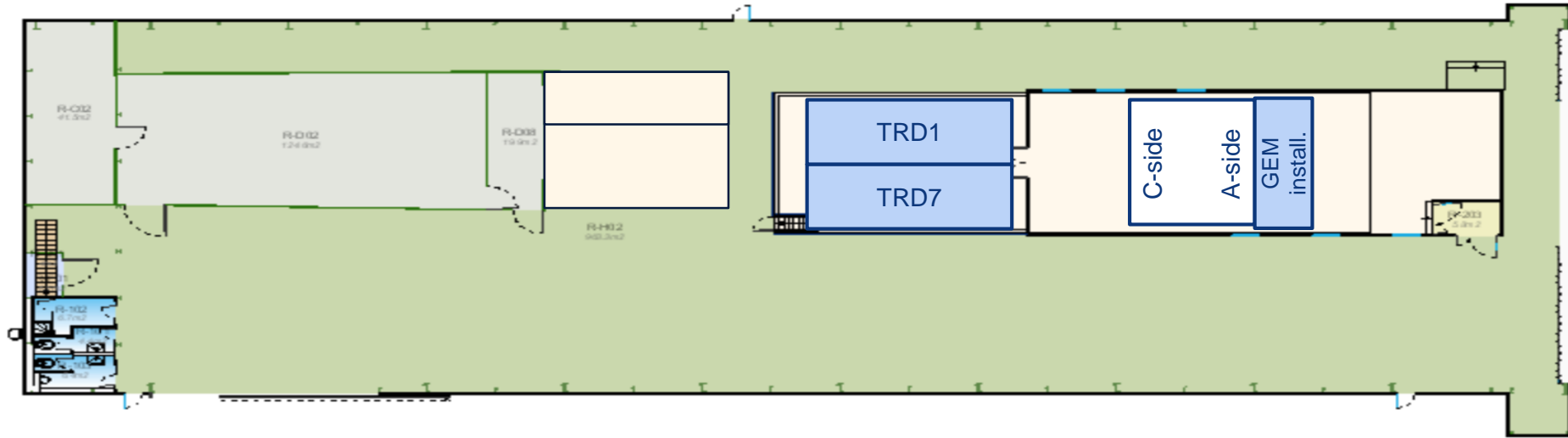

UX25 activities w25 – Tue 18 Jun 2019

ALTEAD: transport PHOS M4 to Meyrin and M2 to P2

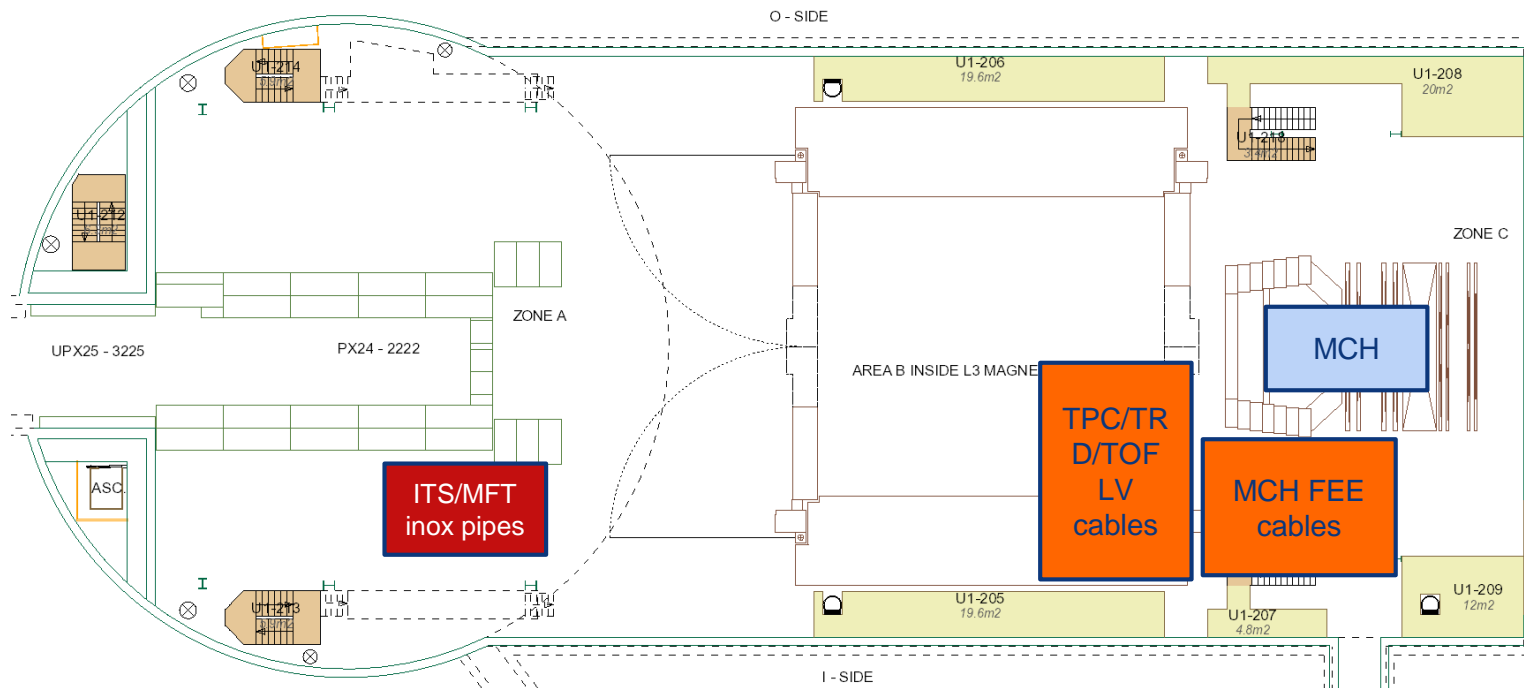

SXL2 activities w25 – Tue 18 Jun 2019

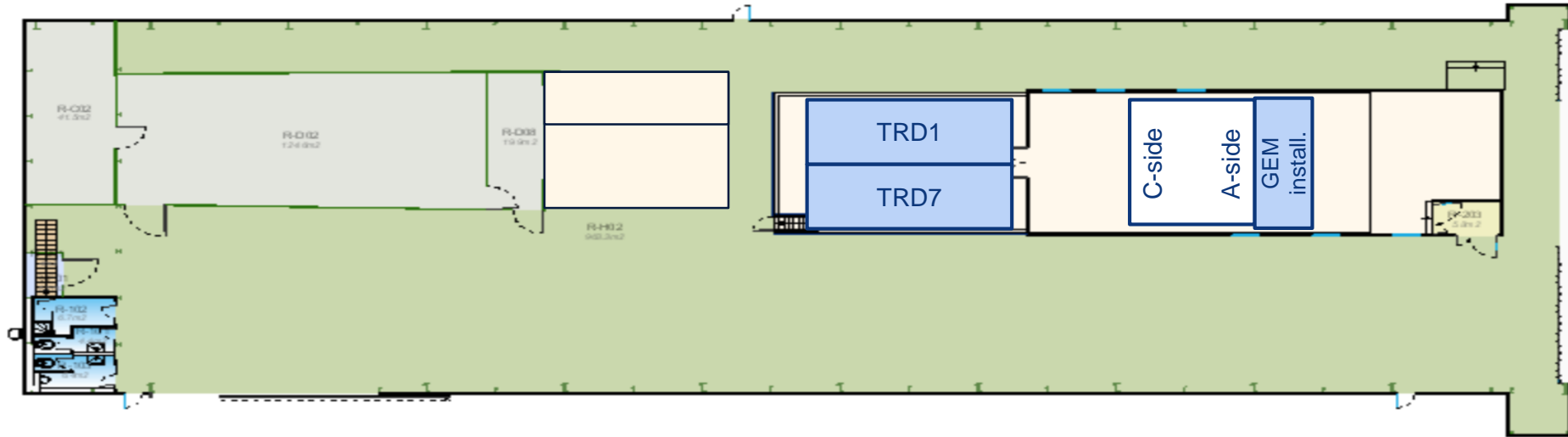

UX25 activities w25 – Wed 19 Jun 2019

ALTEAD: extract TPC pump and PMD gas rack (CR5)

EP-DT (gas): cut TPC gas pipes CR5 (install Y for cleanroom)

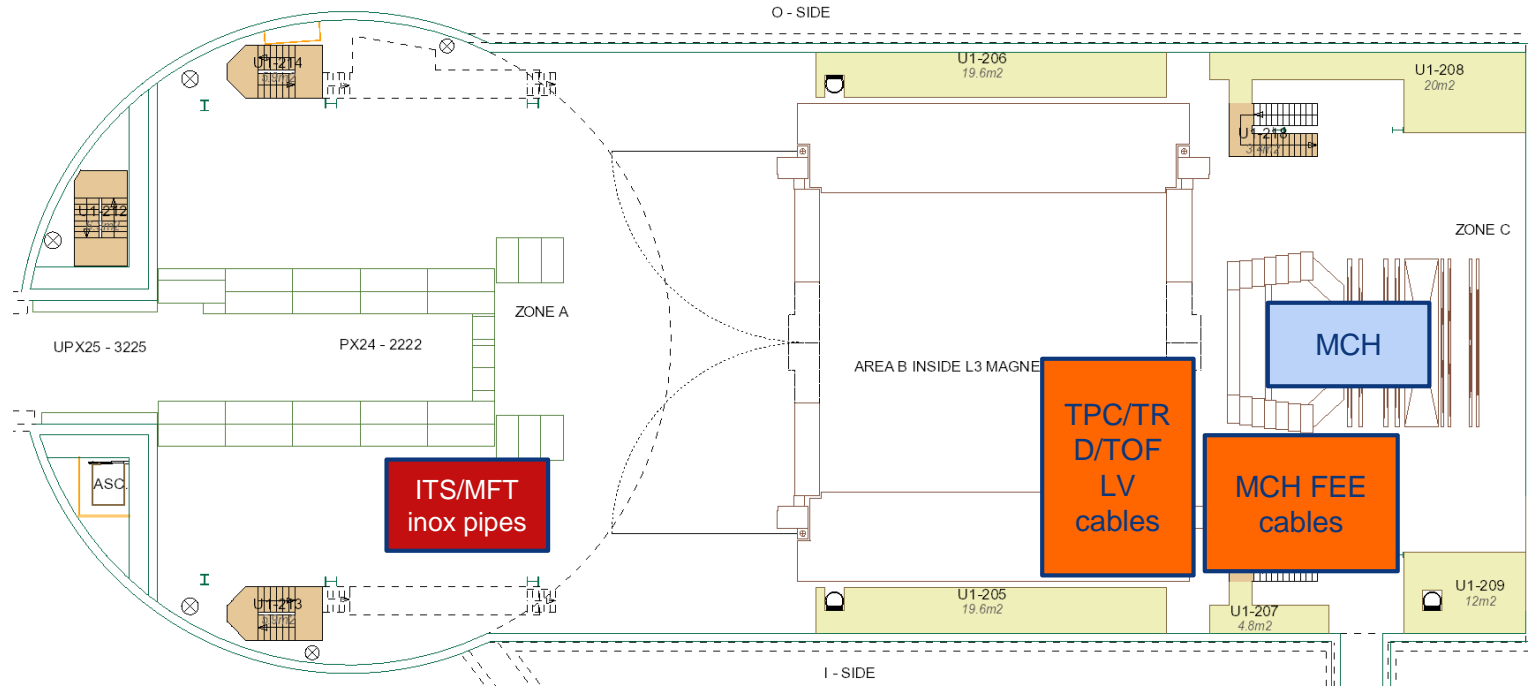

SXL2 activities w25 – Wed 19 Jun 2019

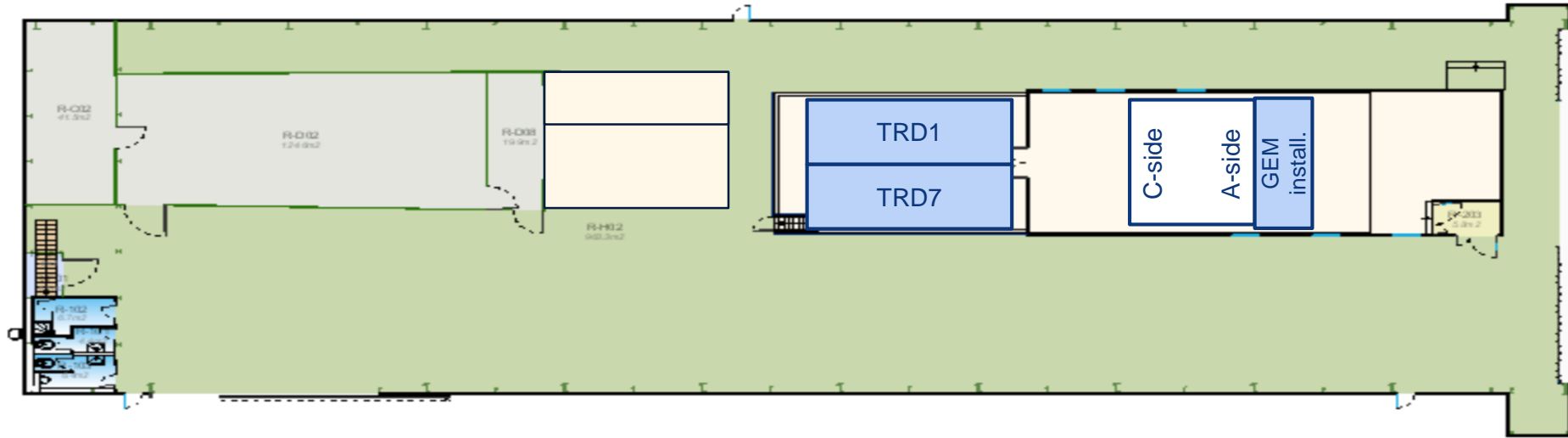

UX25 activities w25 – Thu 20 Jun 2019

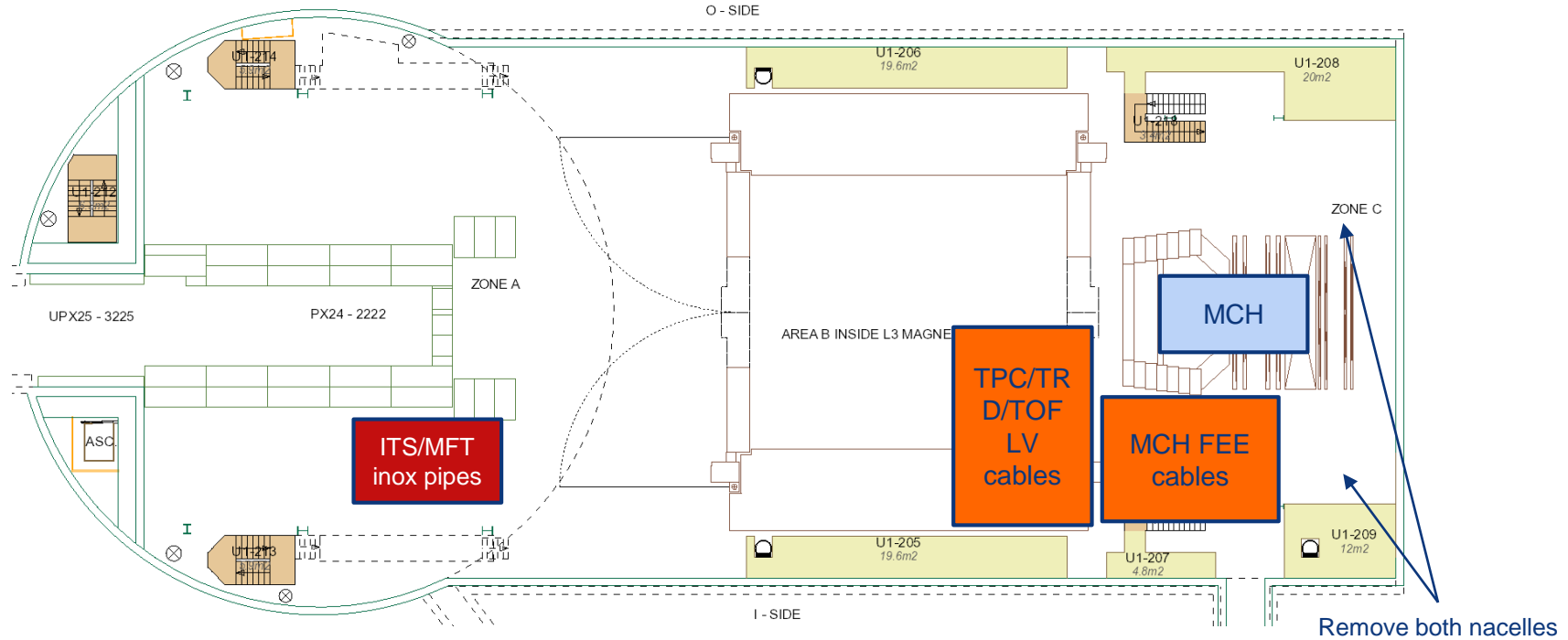

SXL2 activities w25 – Thu 20 Jun 2019

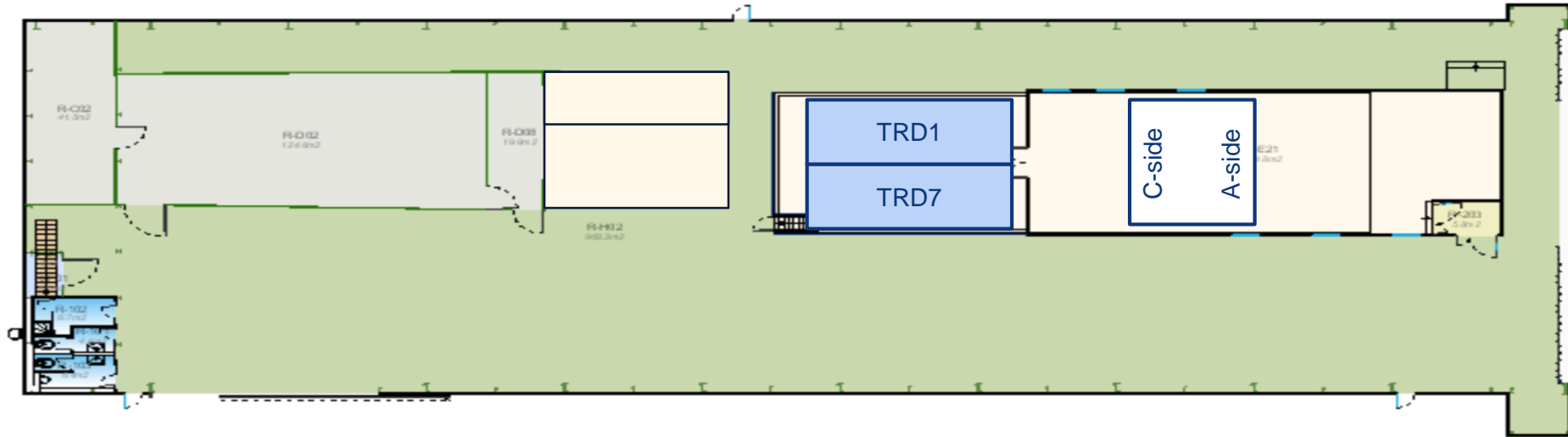

UX25 activities w25 – Fri 21 Jun 2019

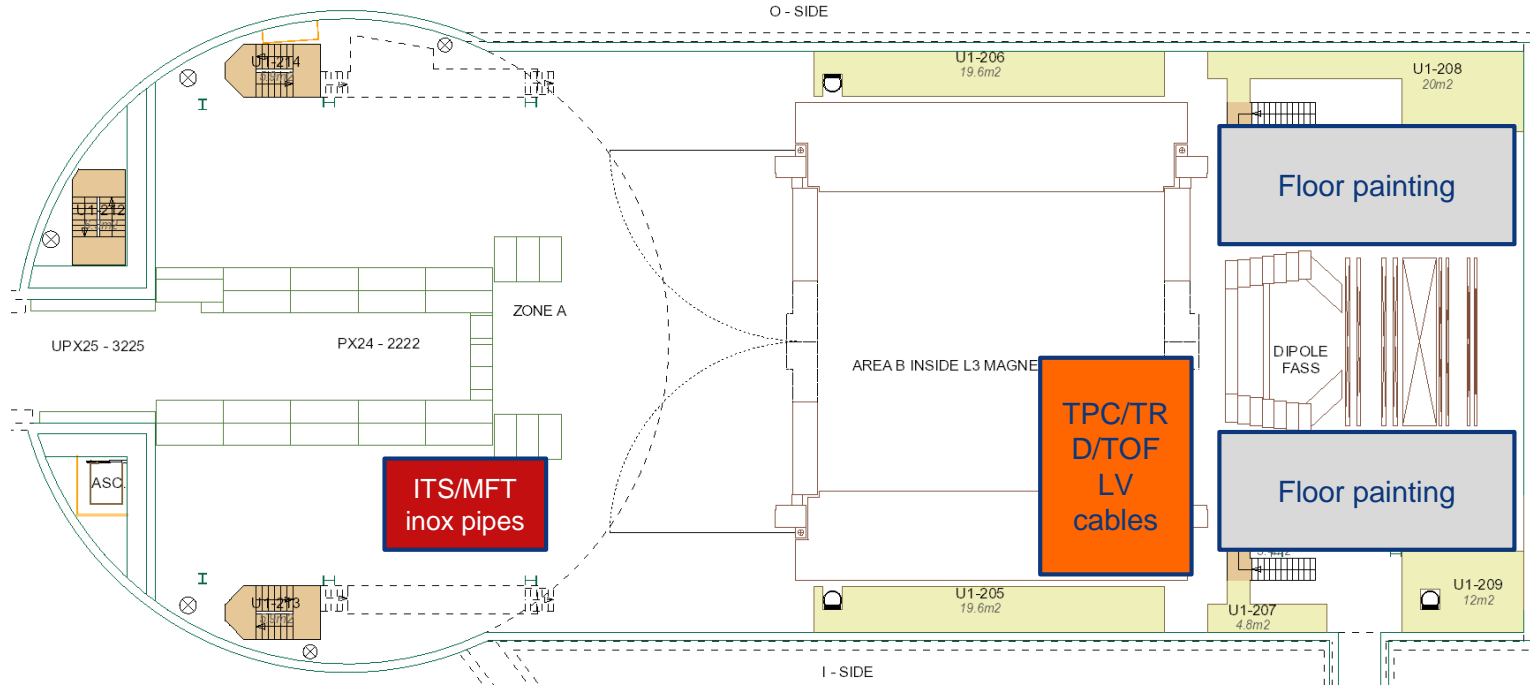

SXL2 activities w25 – Fri 21 Jun 2019

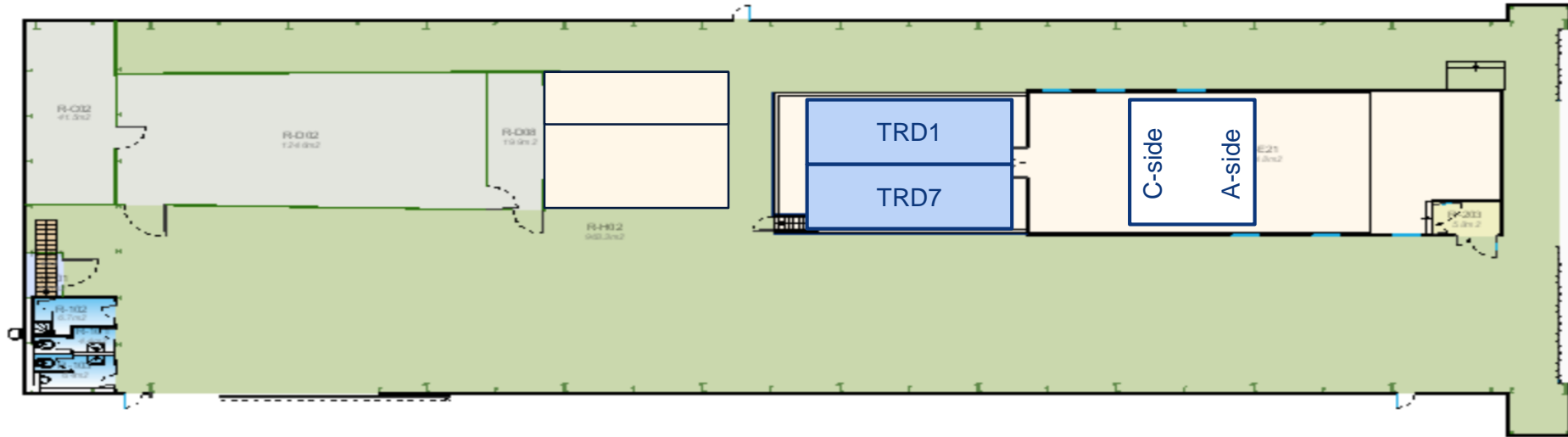

Day-by-day sequence w26

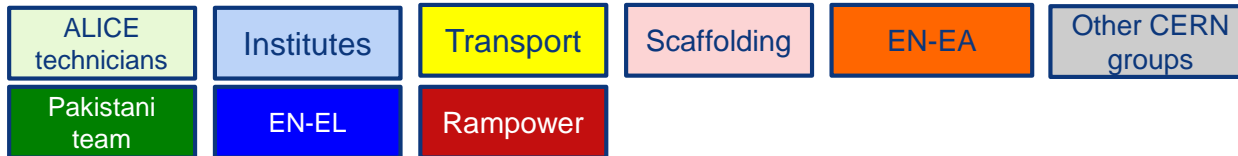

UX25 activities w26 – Mon 24 Jun 2019

Install TPC cooling pipes Miniframe (whole week)

CR0: network connection and wi-fi IT3 (whole week) (IT)

CR0: install DCS monitoring inside IT3 (whole week)

CR0: open Roxtec IT3 (Philippe)

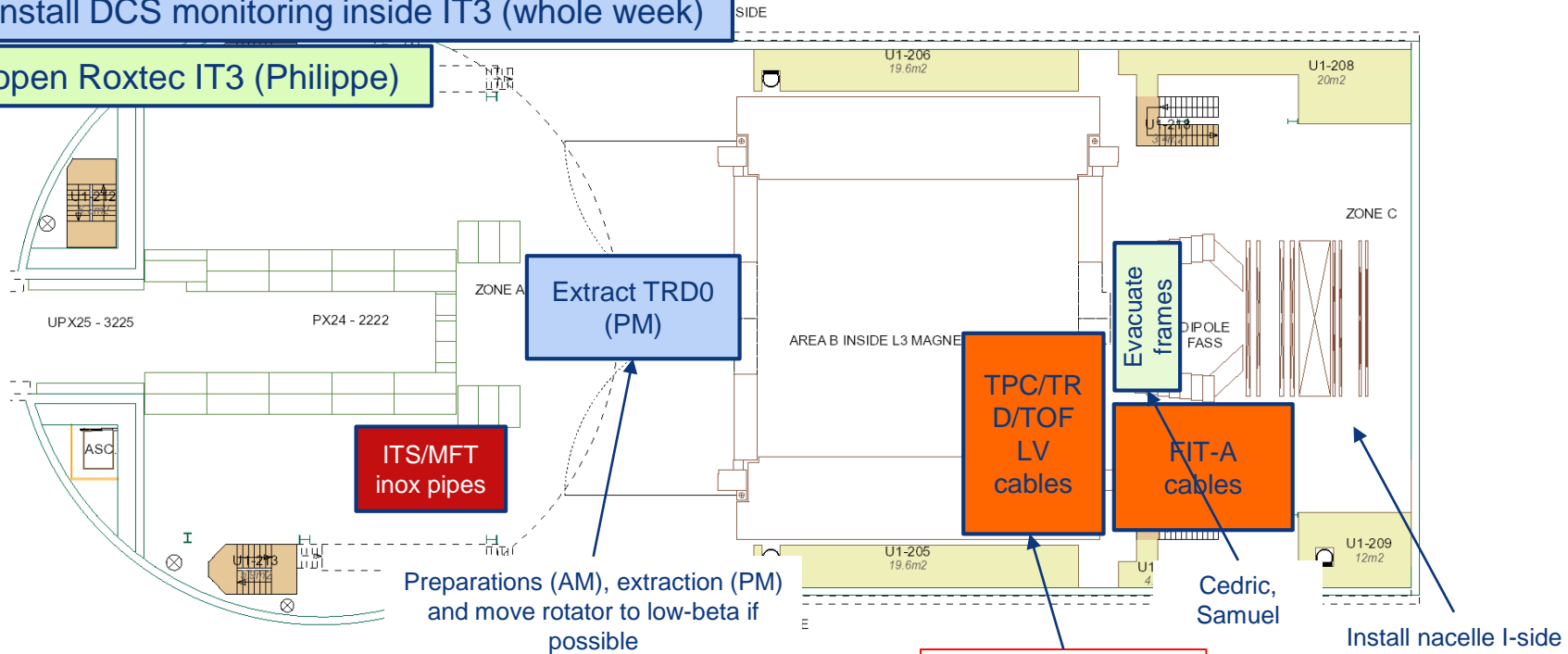

Preparations (AM), extraction (PM) and move rotator to low-beta if possible

Cedric, Samuel

Stop between 14:00 and 16:00

SXL2 activities w26 – Mon 24 Jun 2019

ALTEAD: transport ITS, SPD and FMD3 to SX2 and transport SPD to SXL2

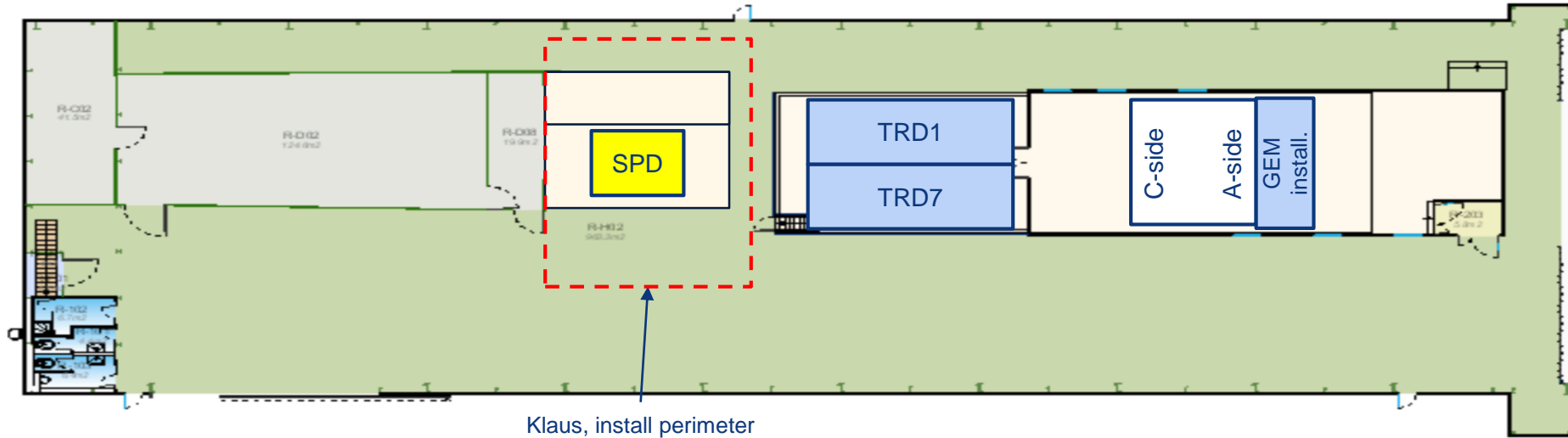

UX25 activities w26 – Tue 25 Jun 2019

Modify TRD table in SX2 + put new fences (Didier)

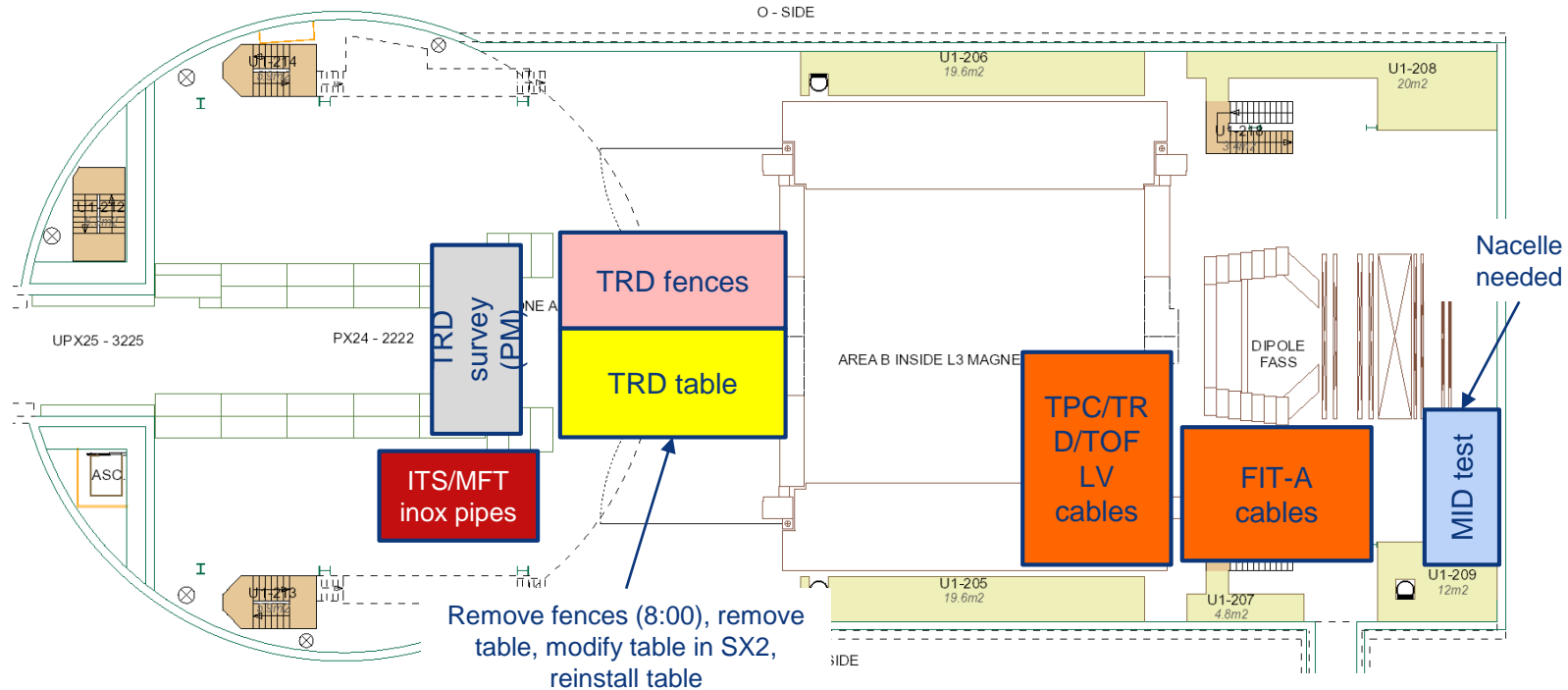

SXL2 activities w26 – Tue 25 Jun 2019

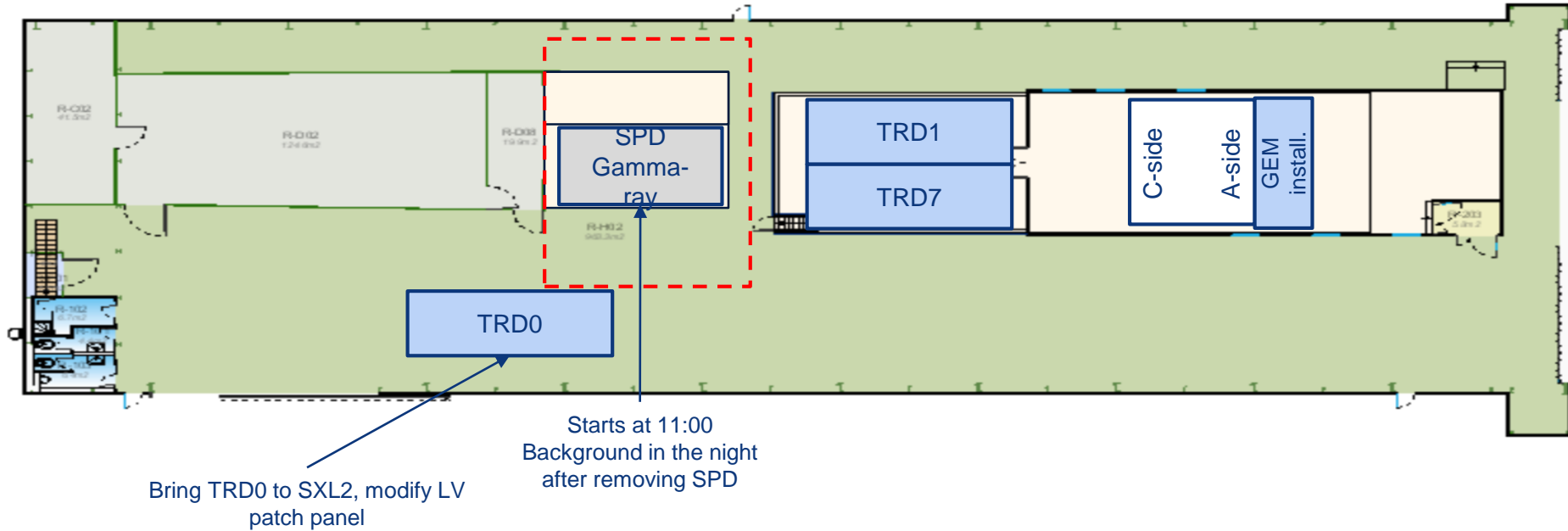

UX25 activities w26 – Wed 26 Jun 2019

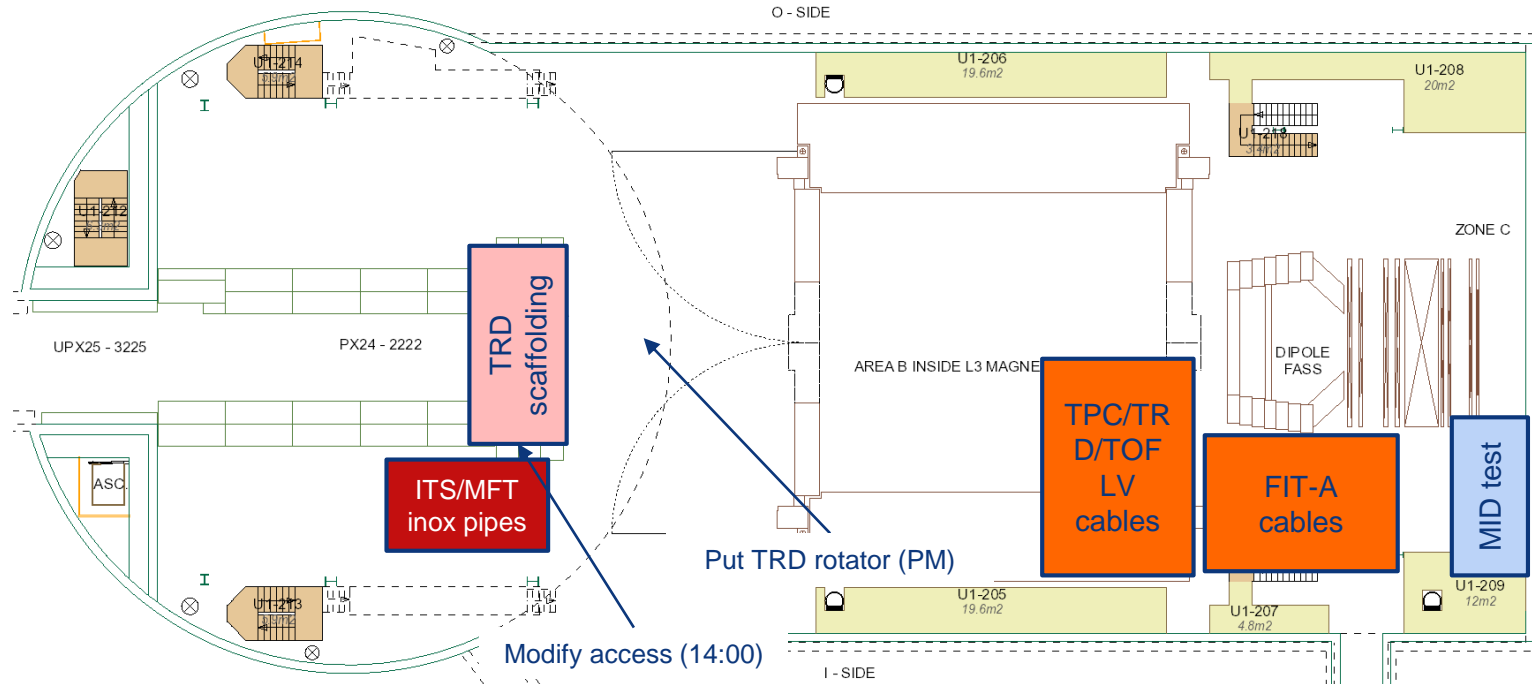

SXL2 activities w26 – Wed 26 Jun 2019

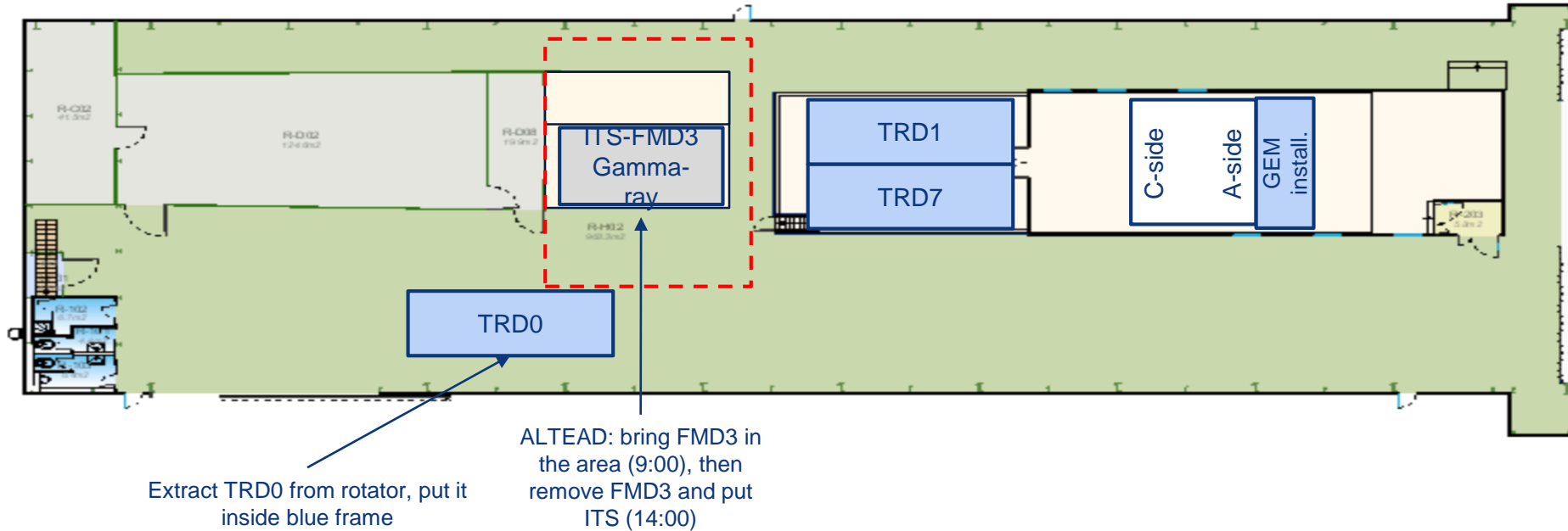

UX25 activities w26 – Thu 27 Jun 2019

TN router replacement (S.Casenove)

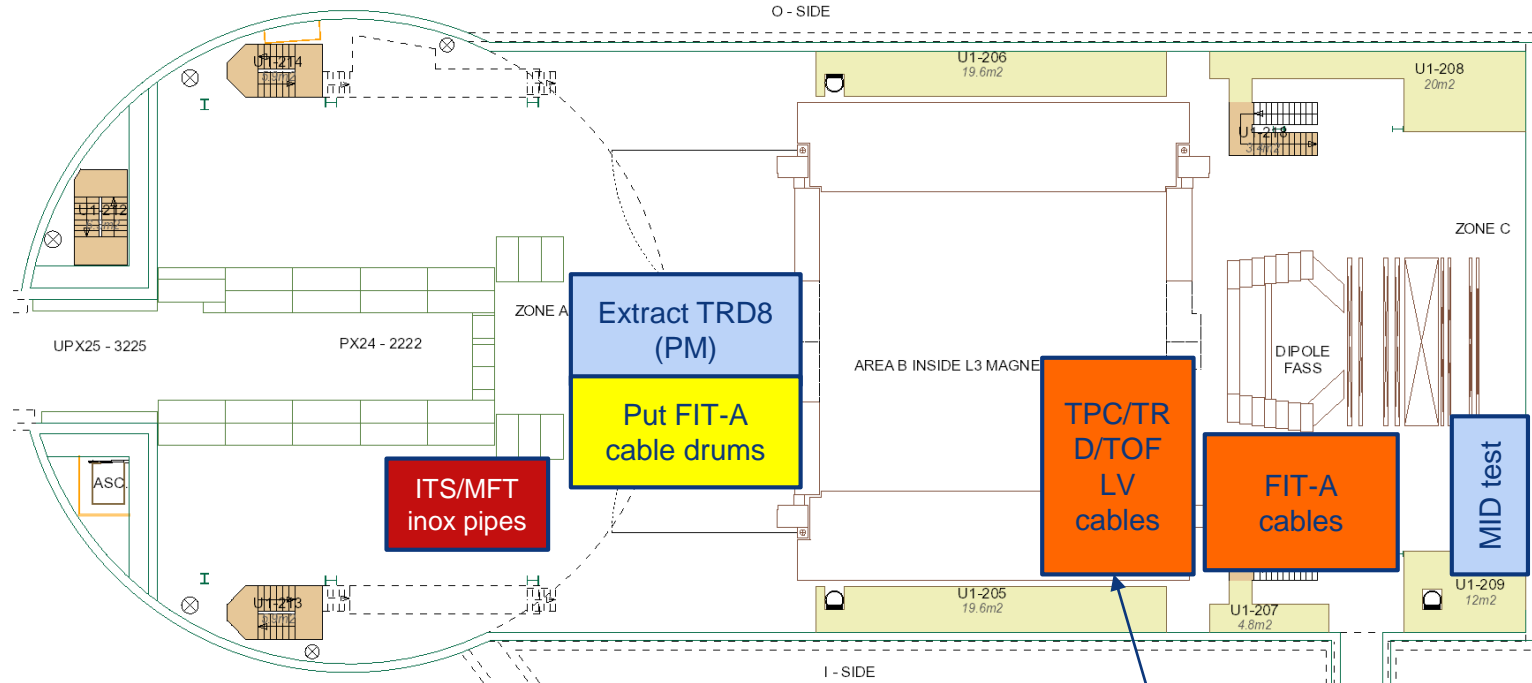

SXL2 activities w26 – Thu 27 Jun 2019

ALTEAD: swap TRD1 and 0. Transfer TRD1 to rotator and back to blue frame

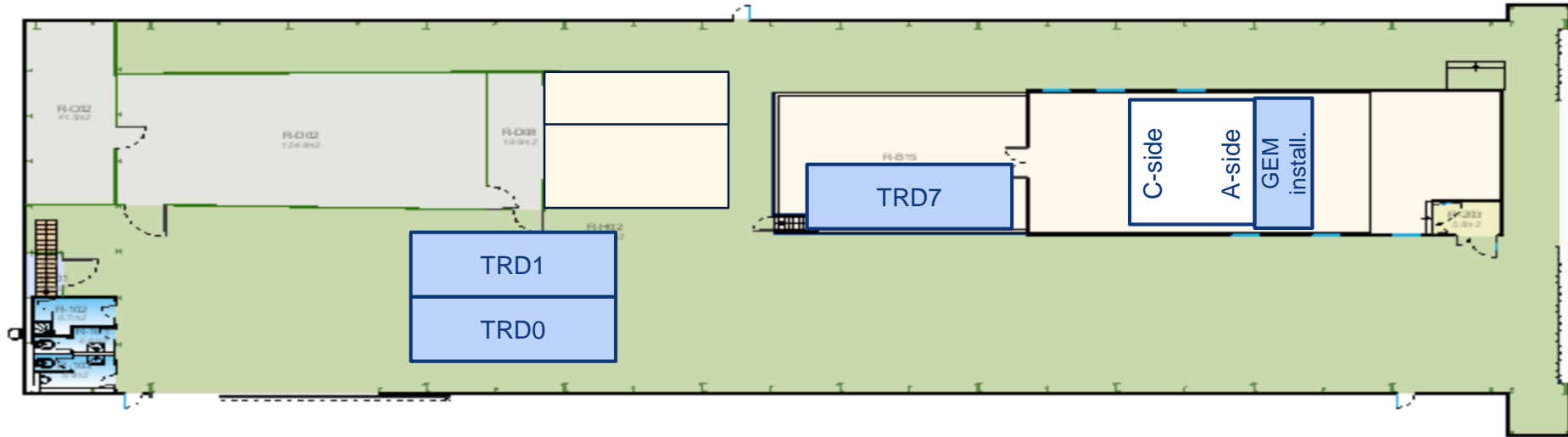

UX25 activities w26 – Fri 28 Jun 2019

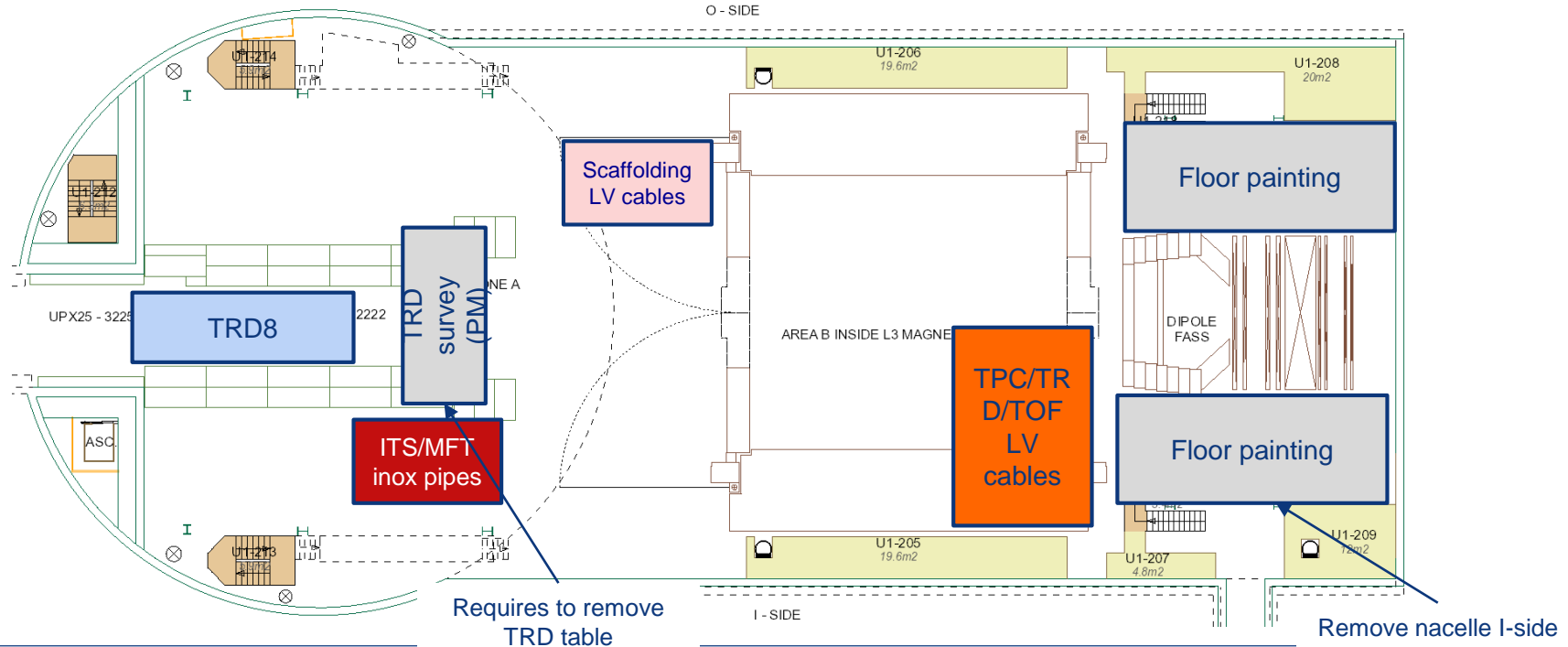

SXL2 activities w26 – Fri 28 Jun 2019

ALTEAD: Move TRD8 & 1 to cavern

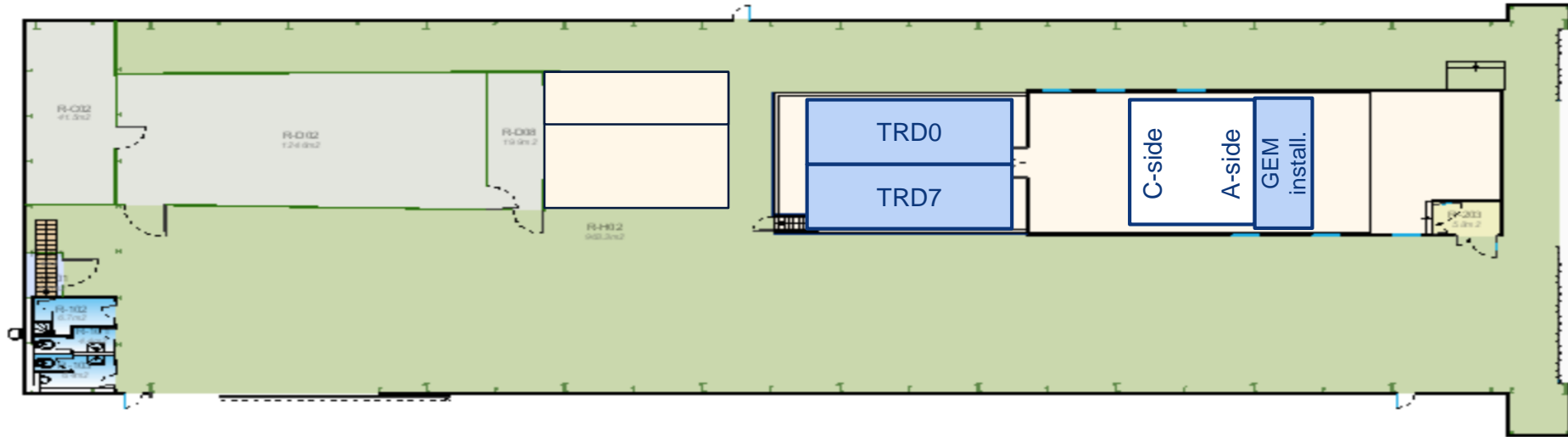

Day-by-day sequence w27



UX25 activities w27 – Mon 1 Jul 2019

Lift maintenance (AS-724): no access to UX25 from 6:00 AM to 8:00 AM

Install TPC cooling pipes Miniframe (whole week)

CR0: close roxtec IT2 (Philippe)

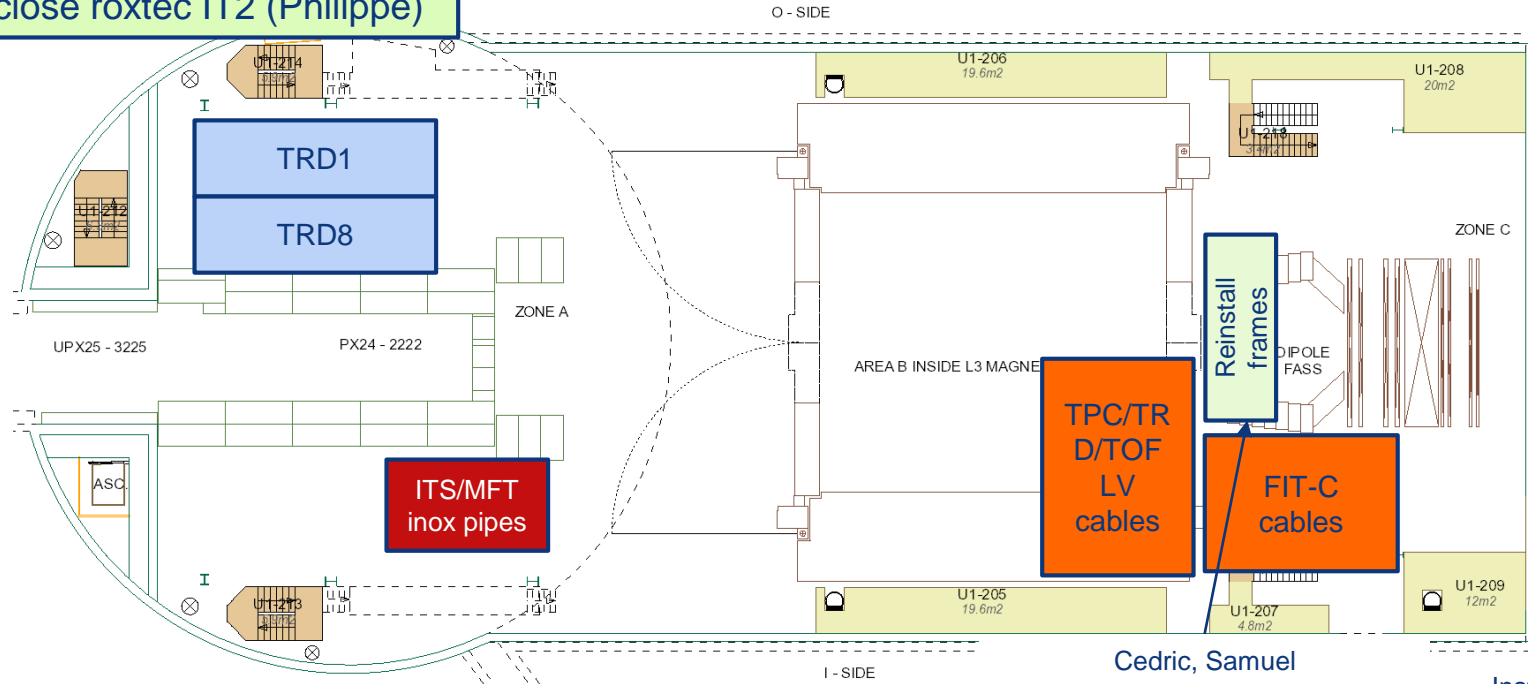

Install nacelle

SXL2 activities w27 – Mon 1 Jul 2019

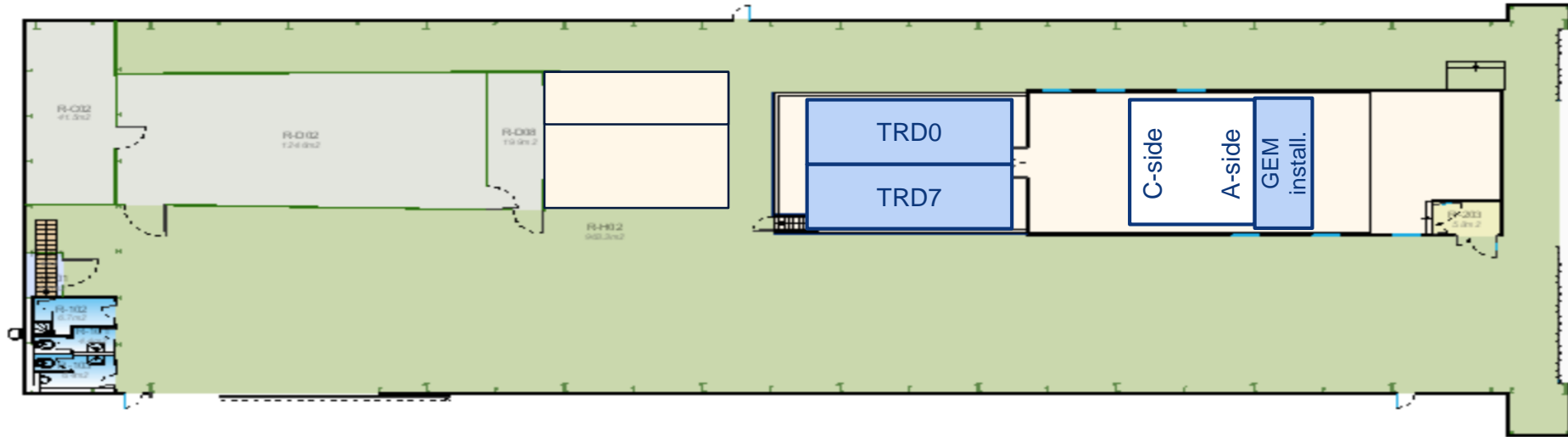

UX25 activities w27 – Tue 2 Jul 2019

CR0: modbus testing (RO plant)

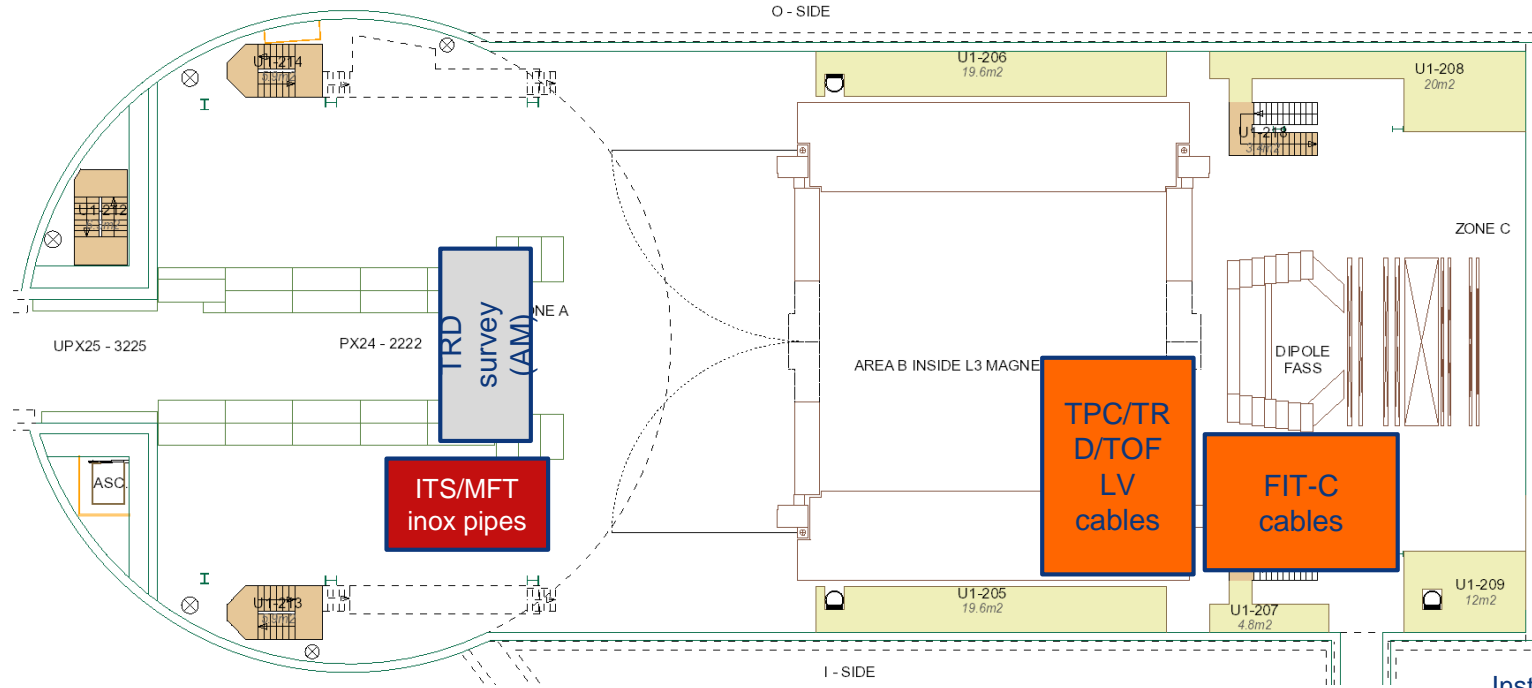

Install nacelle

SXL2 activities w27 – Tue 2 Jul 2019

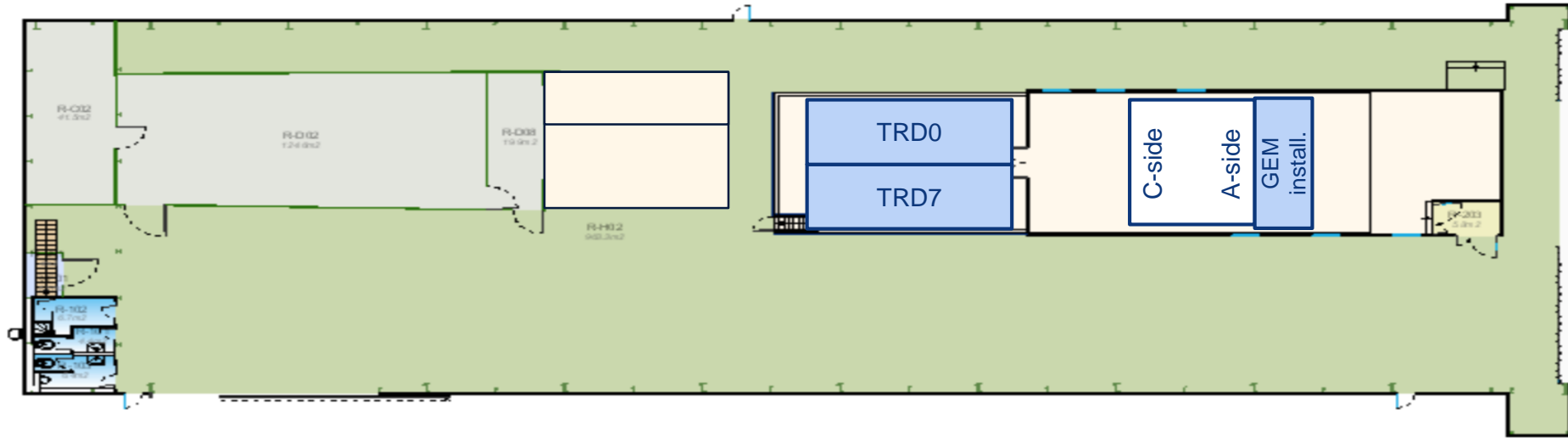

UX25 activities w27 – Wed 3 Jul 2019

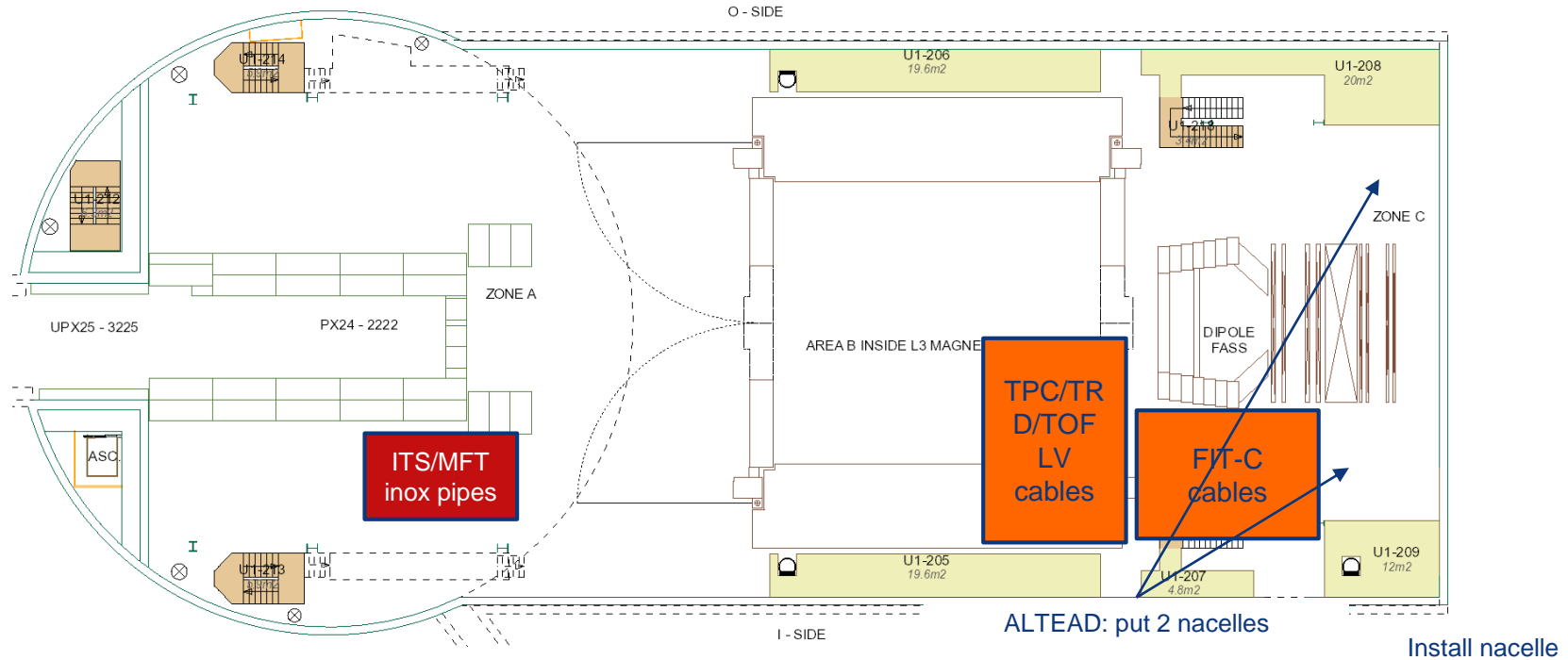

SXL2 activities w27 – Wed 3 Jul 2019

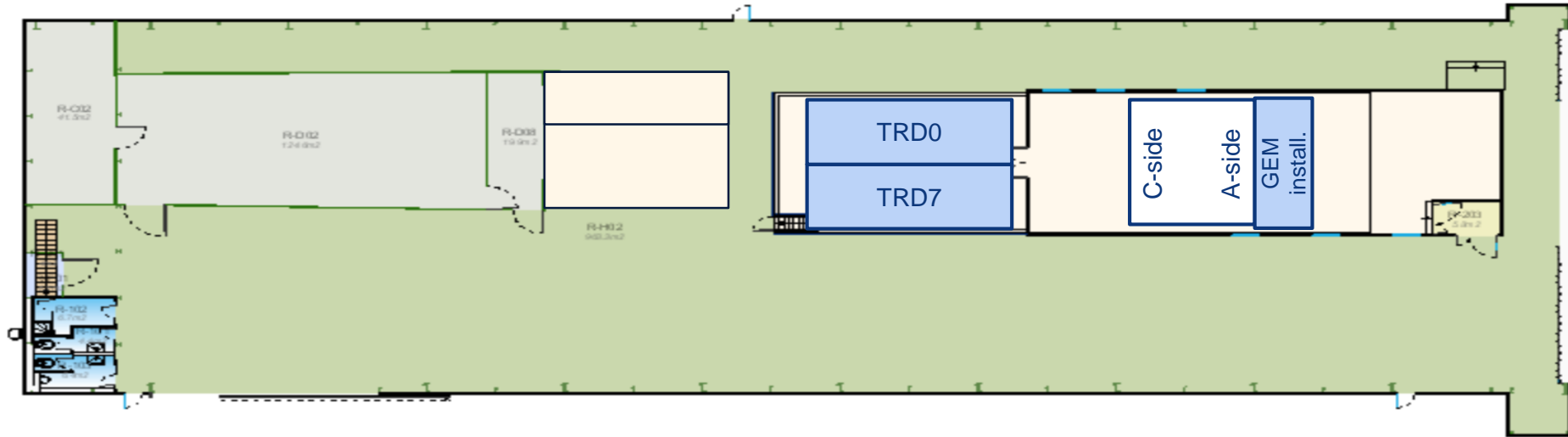

UX25 activities w27 – Thu 4 Jul 2019

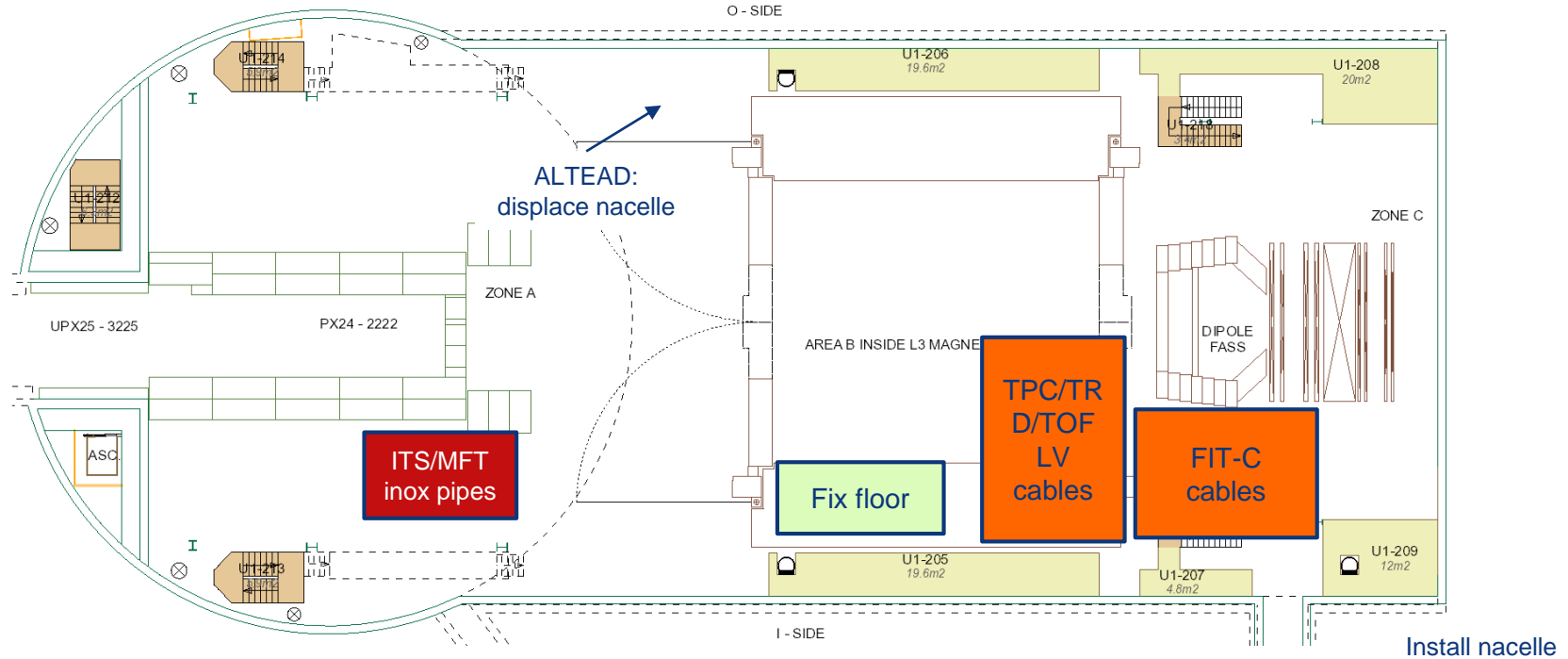

SXL2 activities w27 – Thu 4 Jul 2019

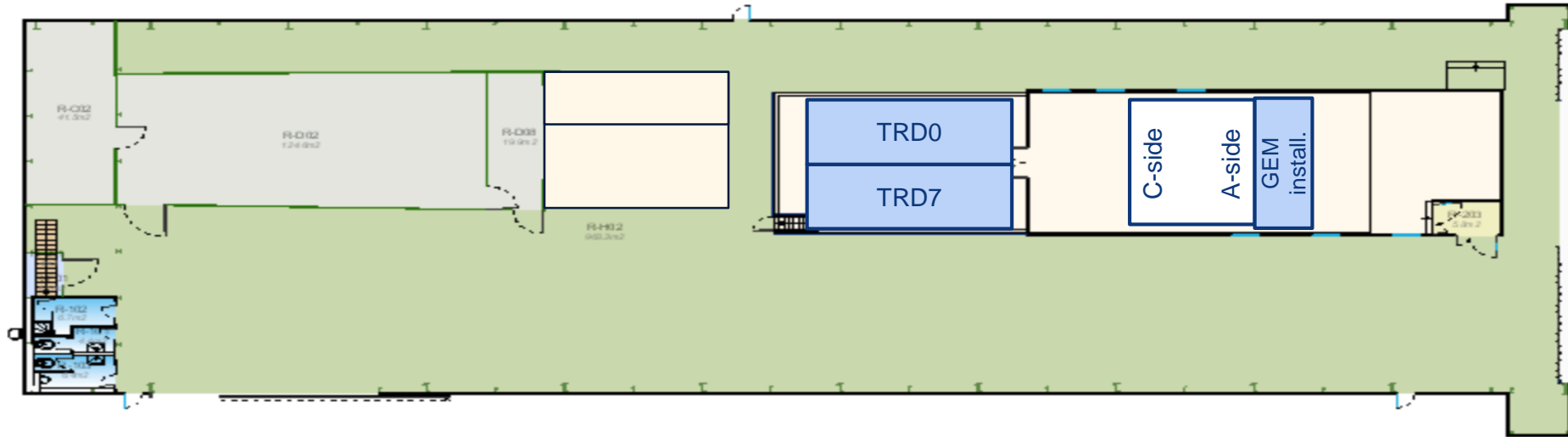

UX25 activities w27 – Fri 5 Jul 2019

Install Miniframe scaffolding

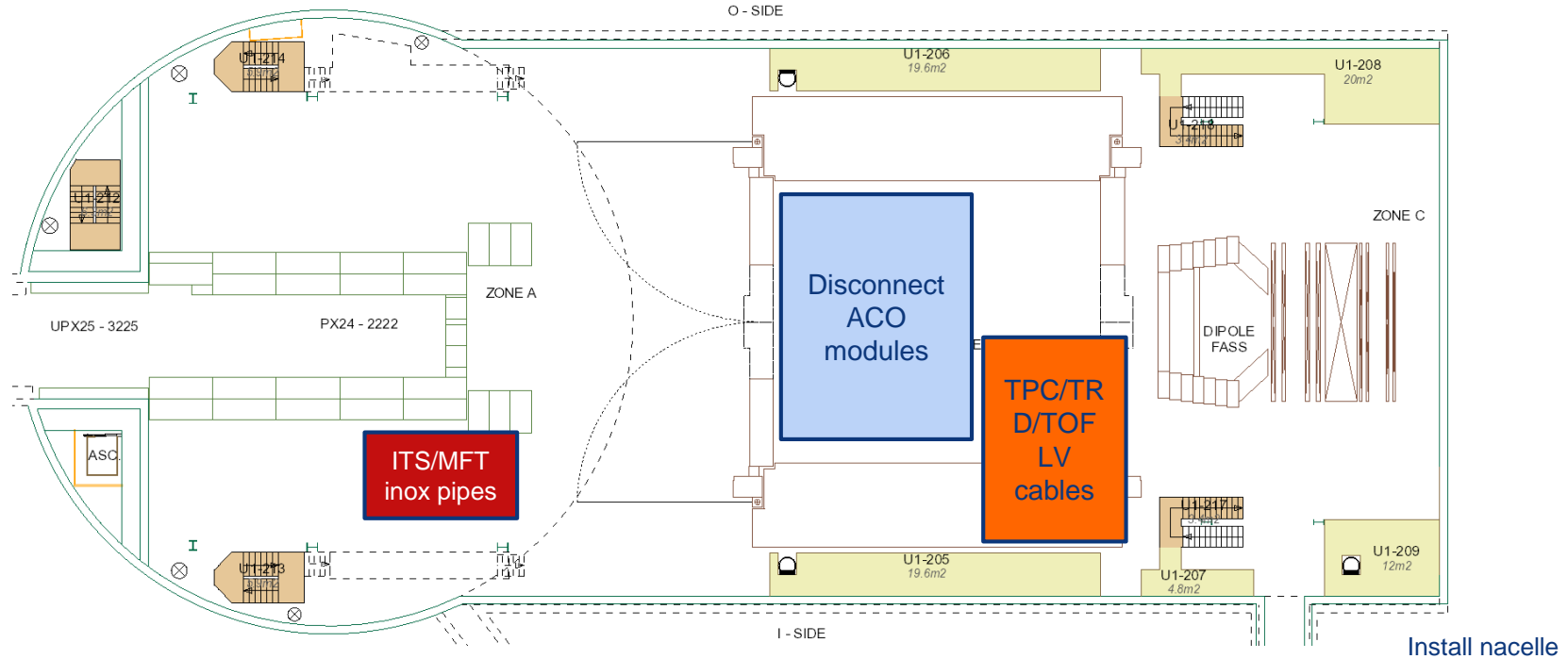

SXL2 activities w27 – Fri 5 Jul 2019

Fill TPC with dry air and test GEM (leakage current test)

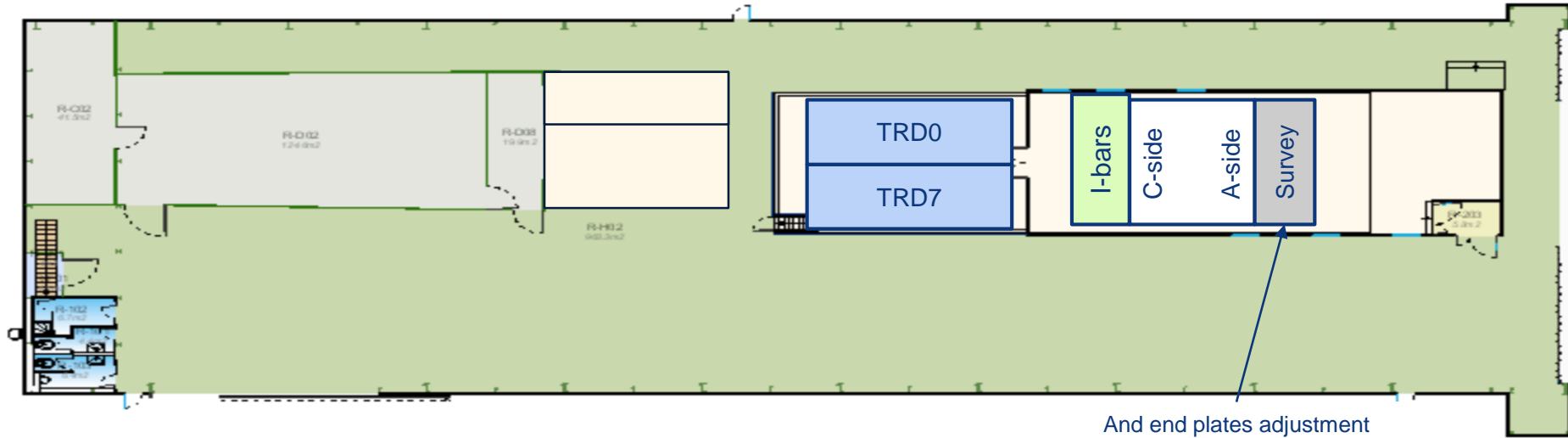

And end plates adjustment

Day-by-day sequence w28

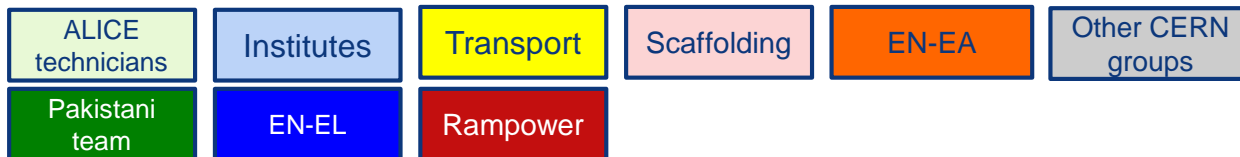

UX25 activities w28 – Mon 8 Jul 2019

CR0: connect IT3 to water (Rampower) – whole week

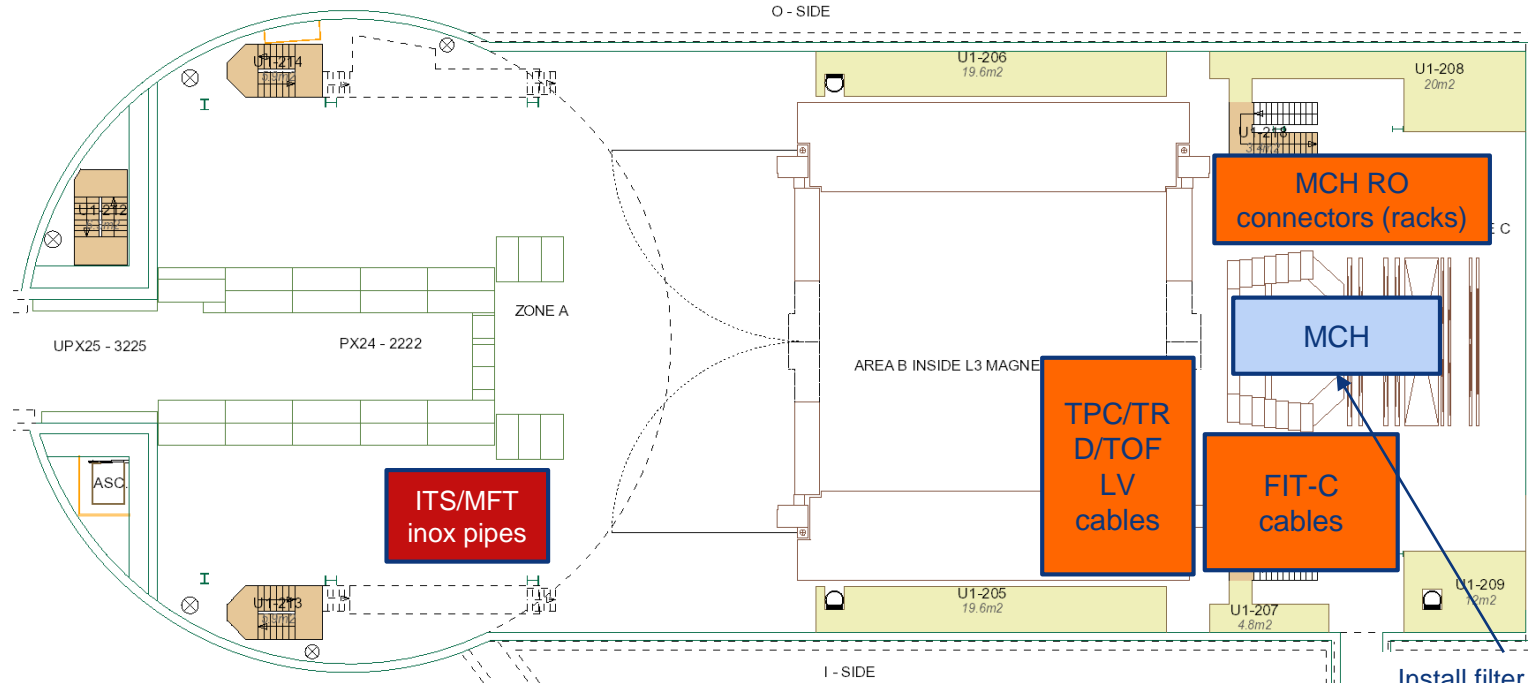

Install filter boxes,
need both nacelles

Miniframe activities w28 – Mon 8 Jul 2019

Install TPC cooling pipes

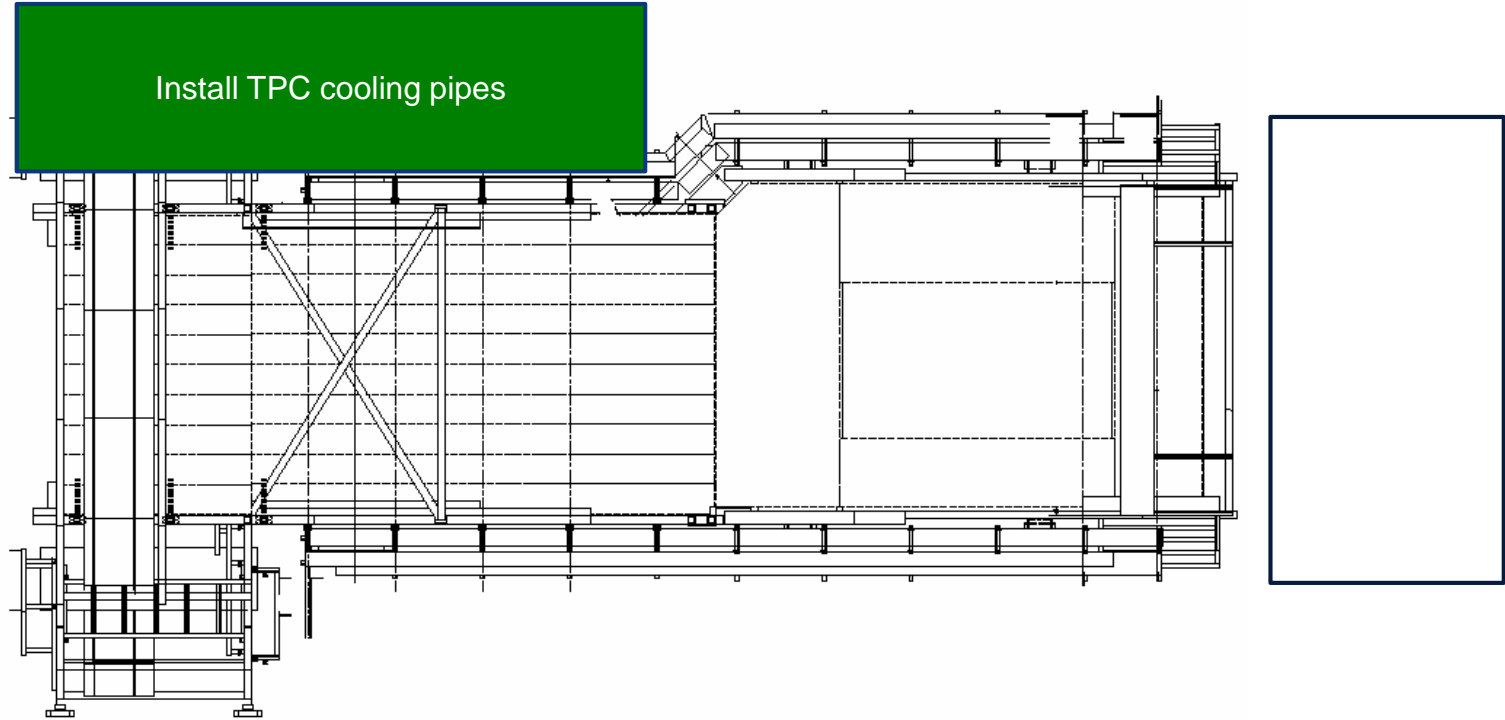

SXL2 activities w28 – Mon 8 Jul 2019

ALTEAD: take out TRD0 from swimming pool and bring TRD8 to SXL2

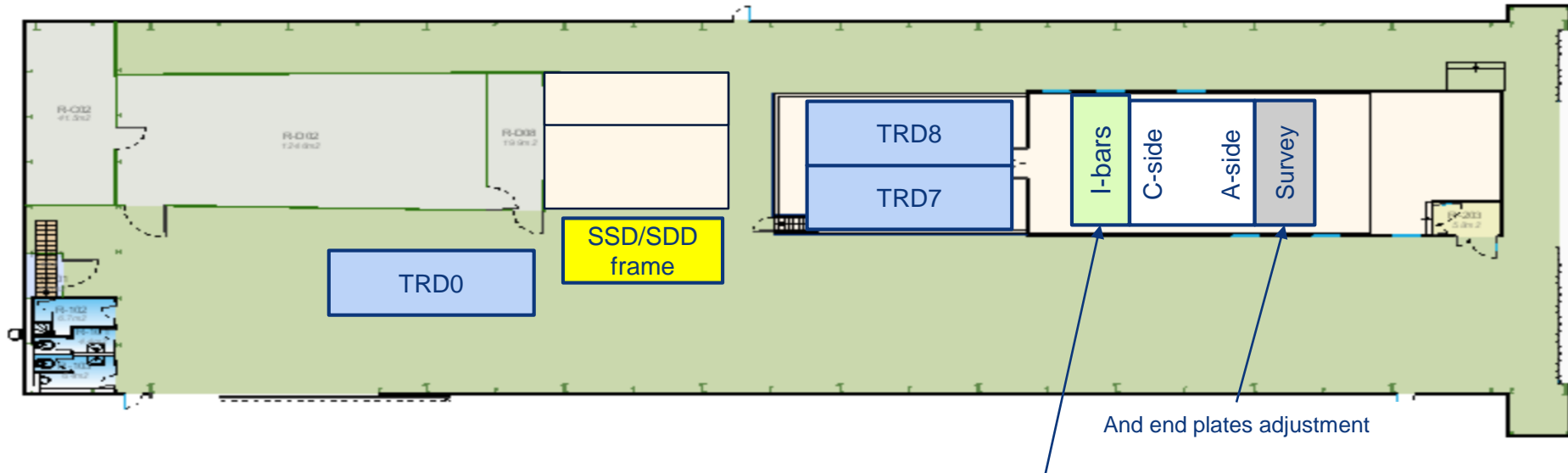

And end plates adjustment

Yannick: appointment at 10:30 for new scaffolding (Alu-It)

UX25 activities w28 – Tue 9 Jul 2019

ALTEAD: load test P2 cranes

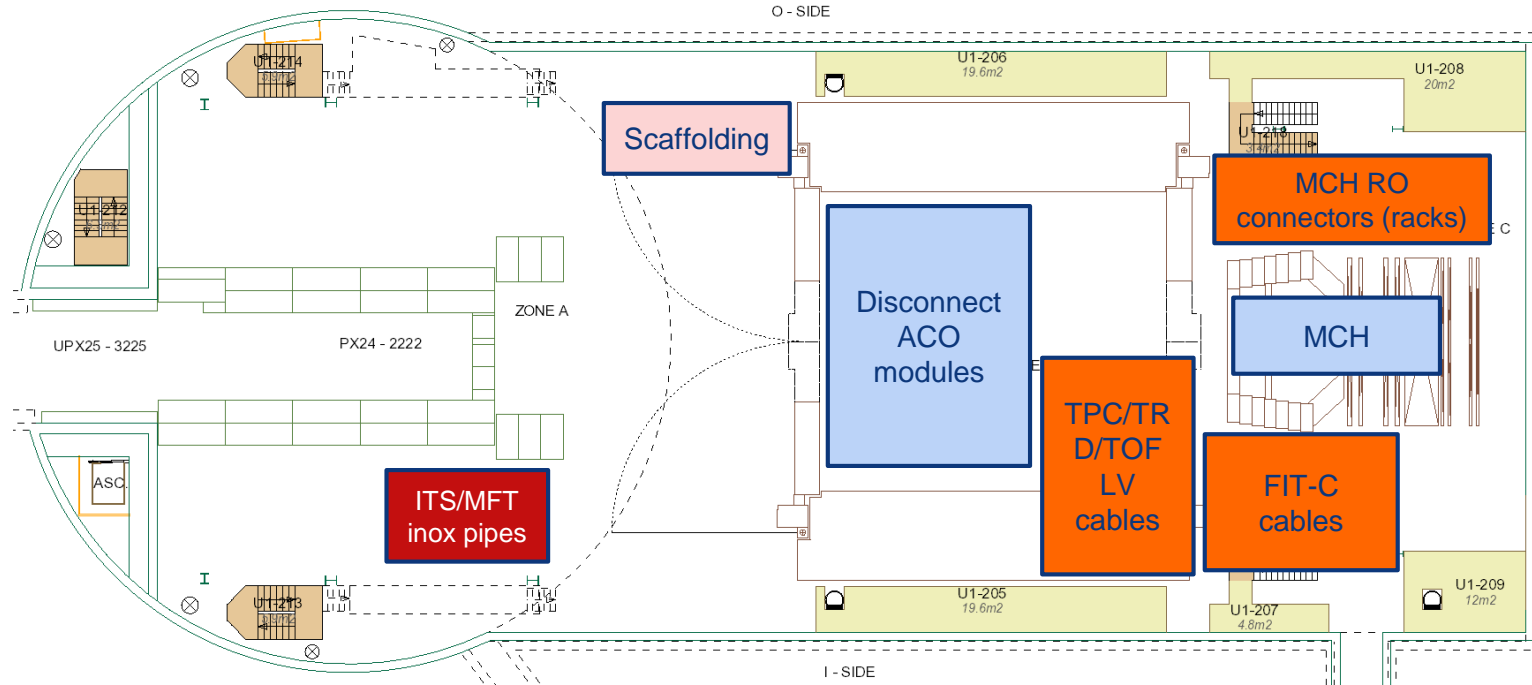

Miniframe activities w28 – Tue 9 Jul 2019

Install TPC cooling pipes

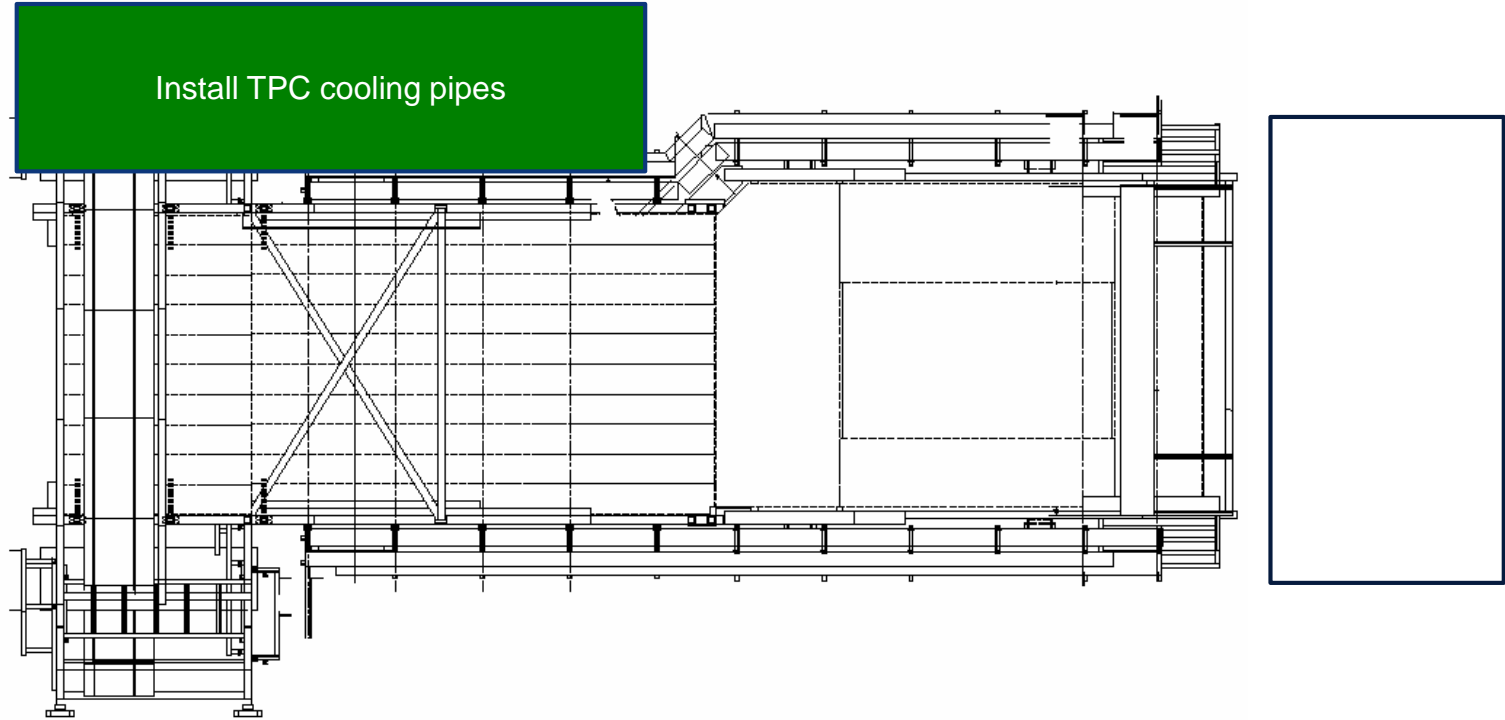

SXL2 activities w28 – Tue 9 Jul 2019

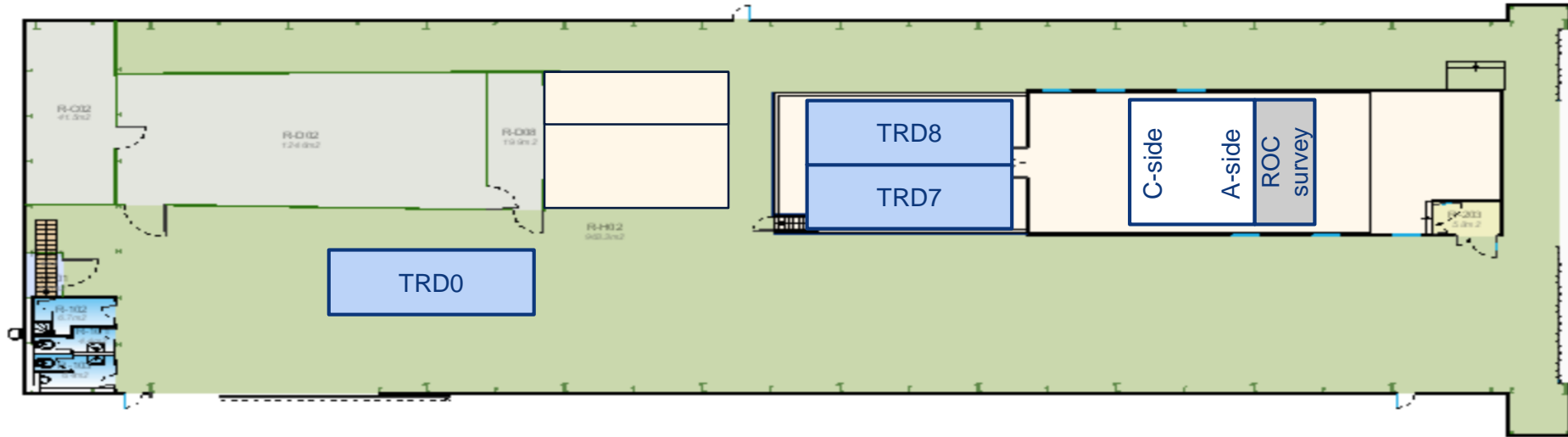

UX25 activities w28 – Wed 10 Jul 2019

ALTEAD: load test P2 cranes

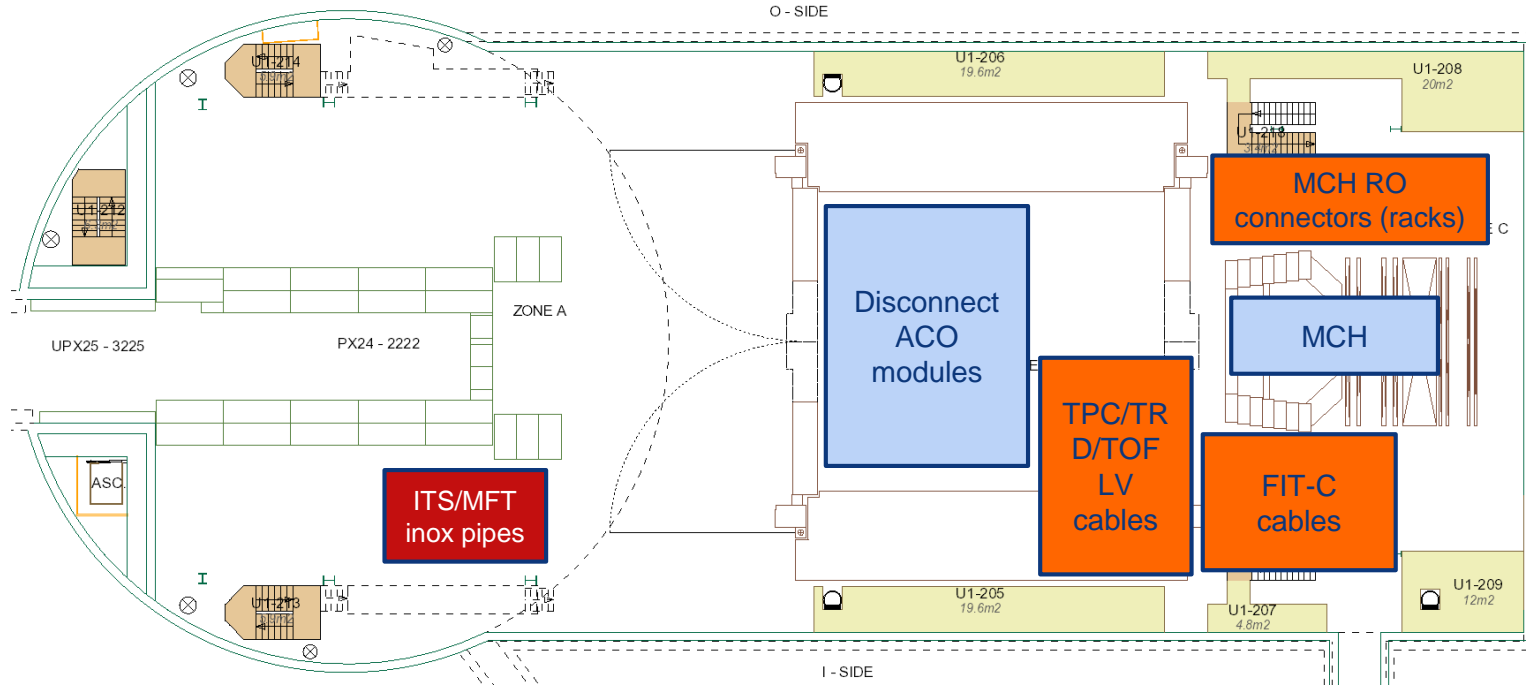

Miniframe activities w28 – Wed 10 Jul 2019

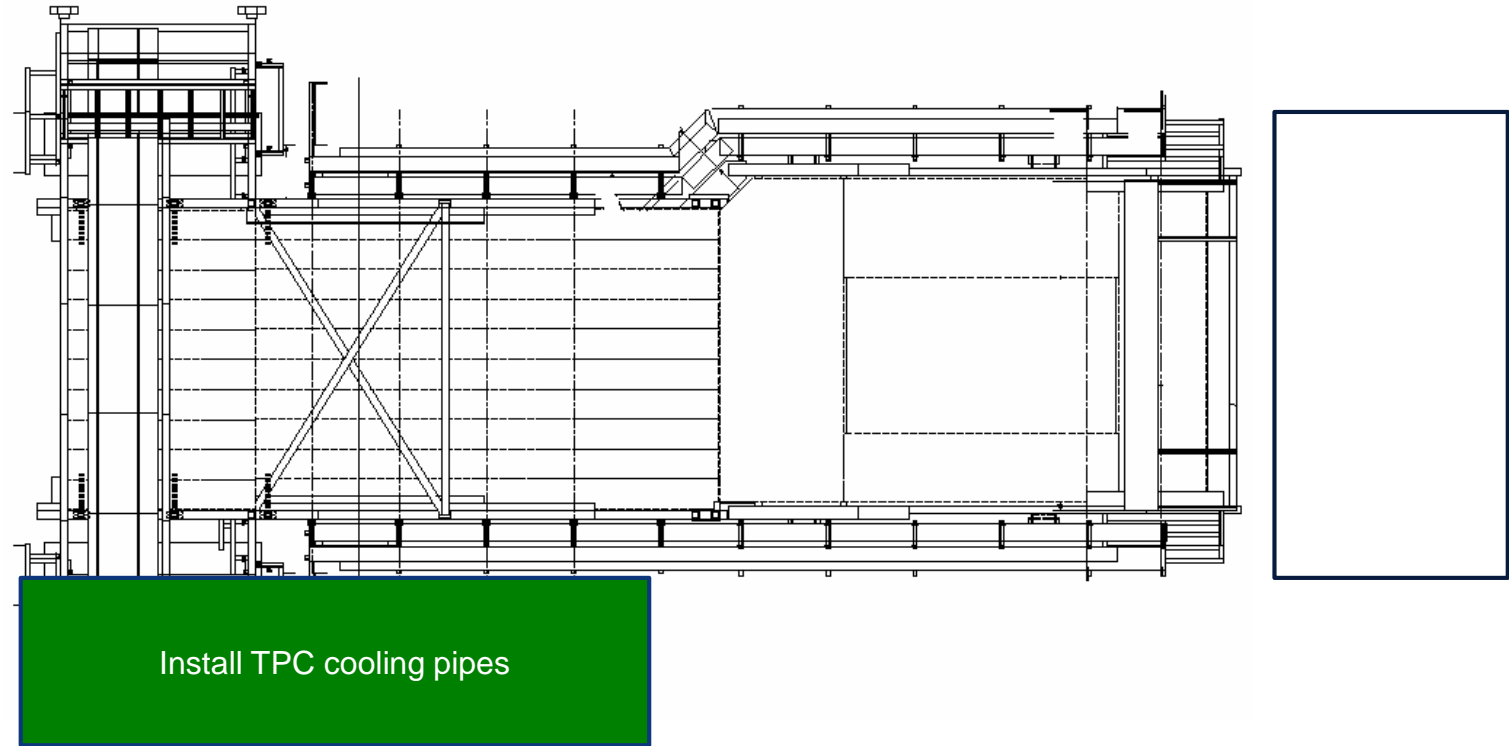

SXL2 activities w28 – Wed 10 Jul 2019

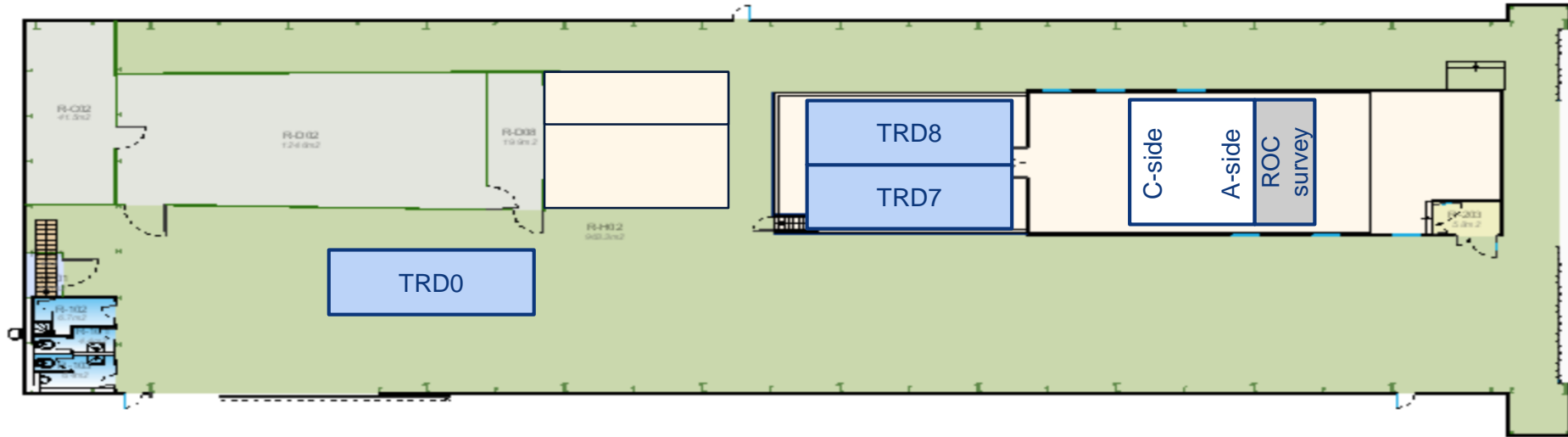

UX25 activities w28 – Thu 11 Jul 2019

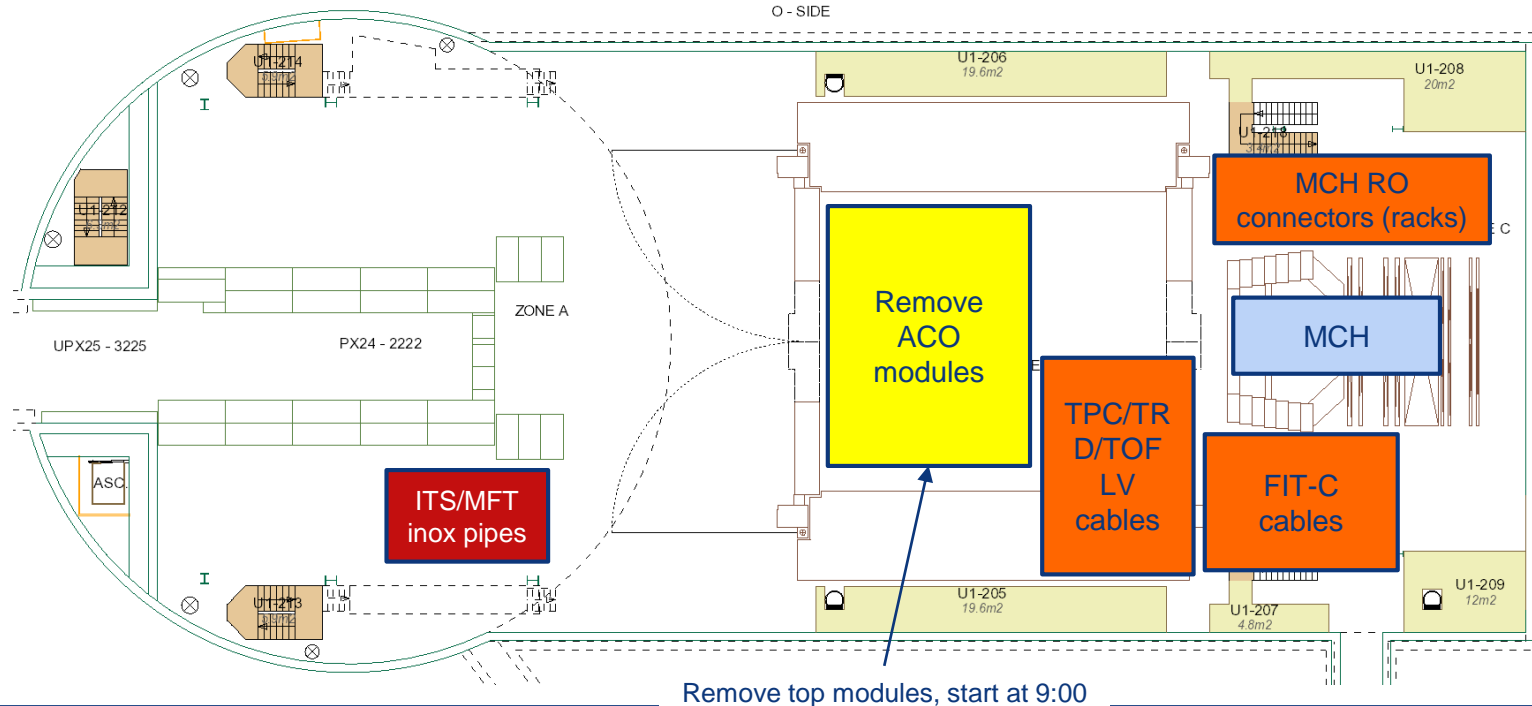

Remove top modules, start at 9:00

Miniframe activities w28 – Thu 11 Jul 2019

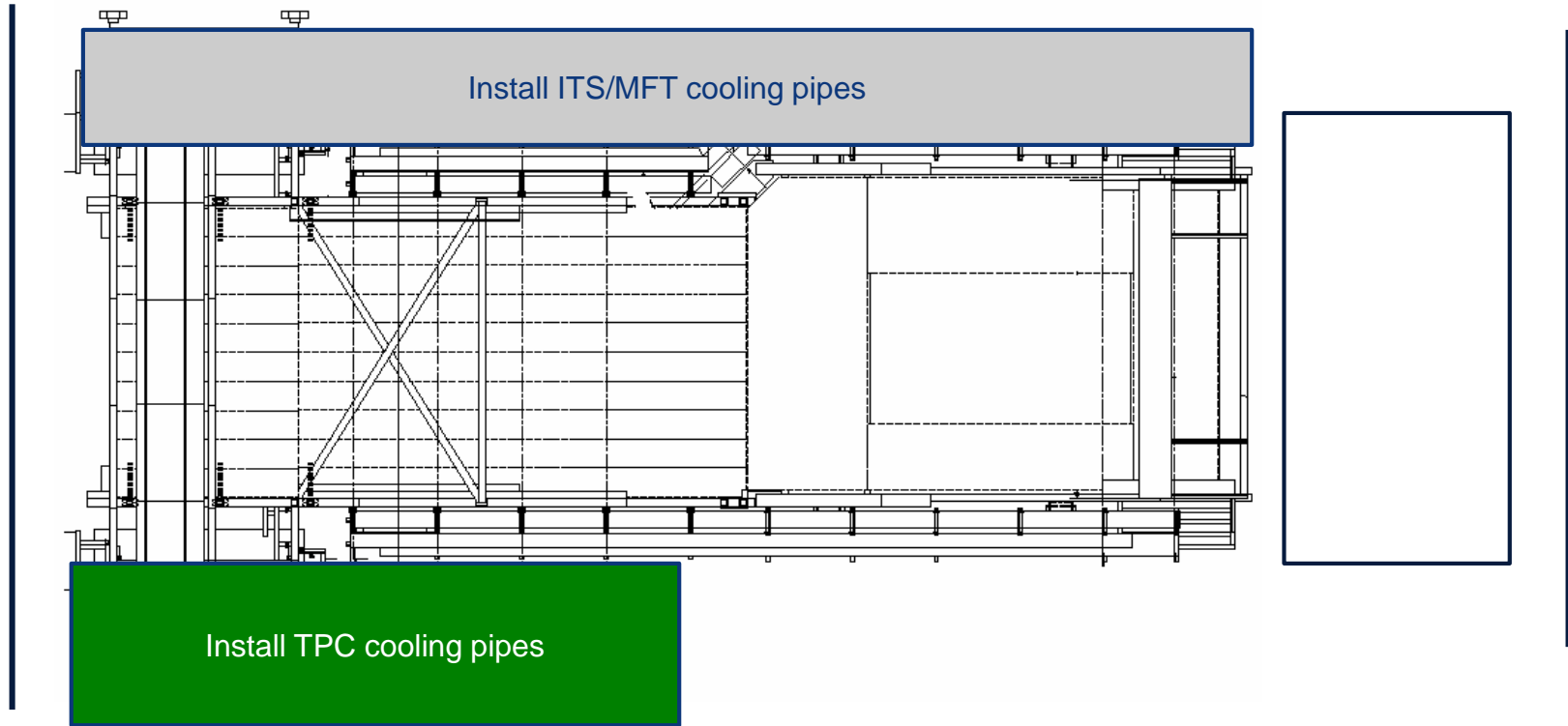

SXL2 activities w28 – Thu 11 Jul 2019

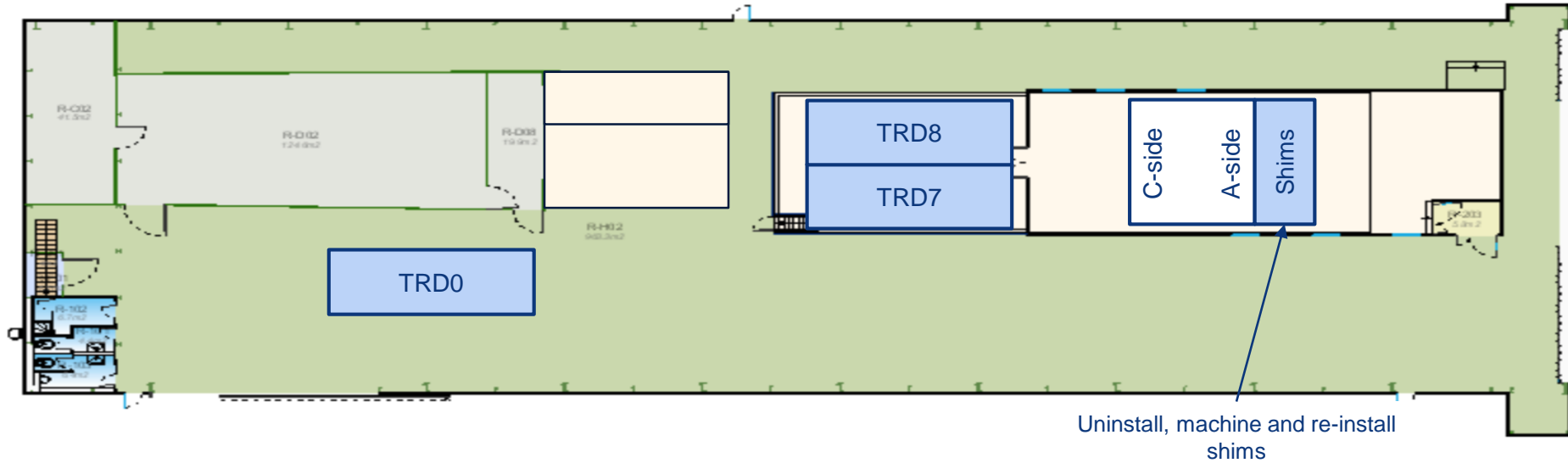

UX25 activities w28 – Fri 12 Jul 2019

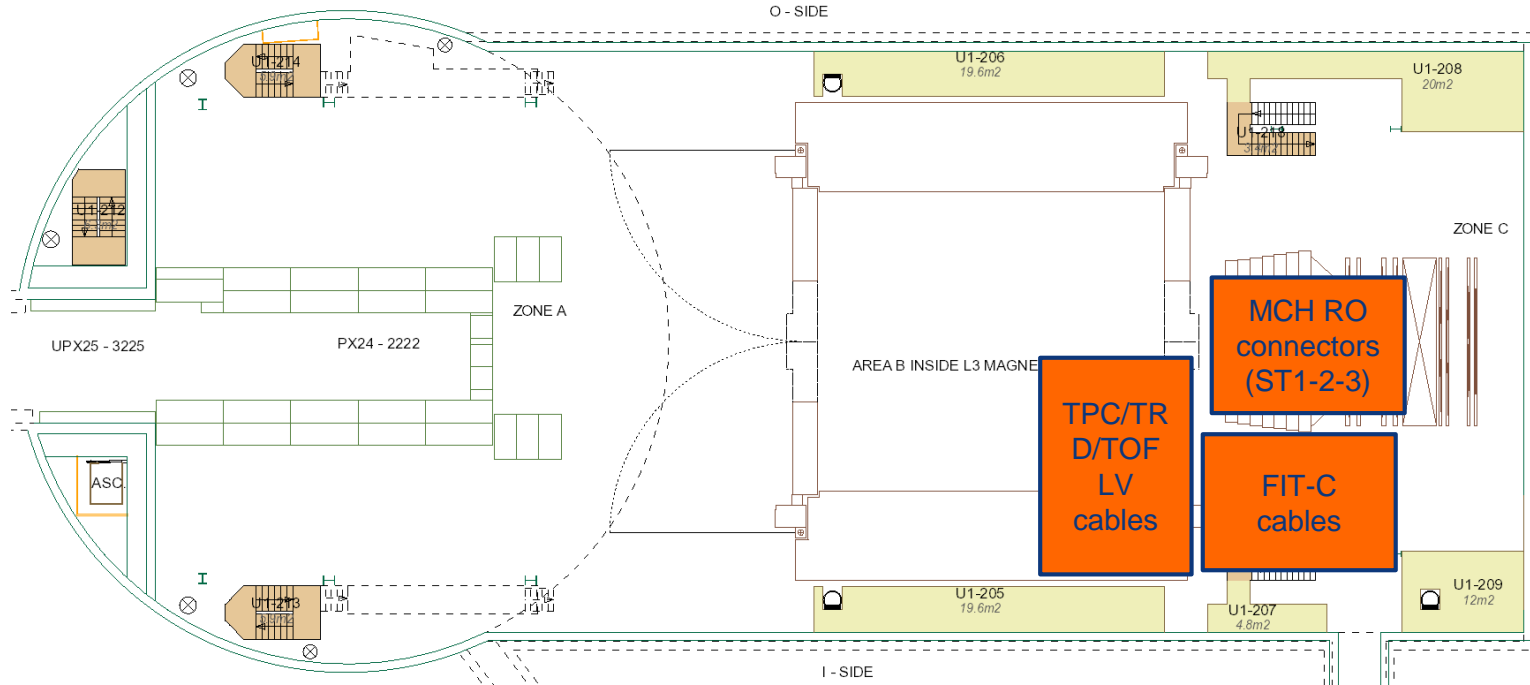

Miniframe activities w28 – Fri 12 Jul 2019

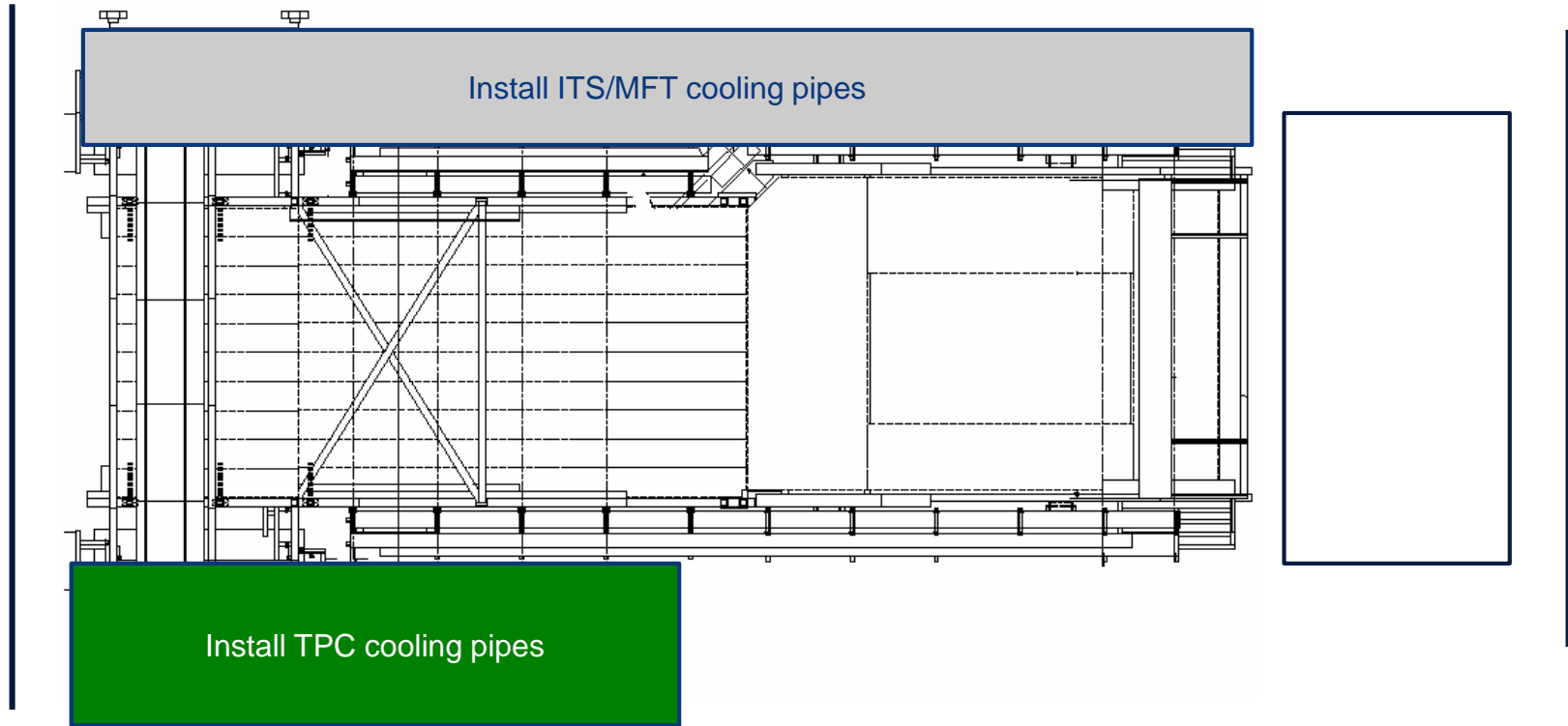

SXL2 activities w28 – Fri 12 Jul 2019

ALTEAD: bring TRD0 to UX25

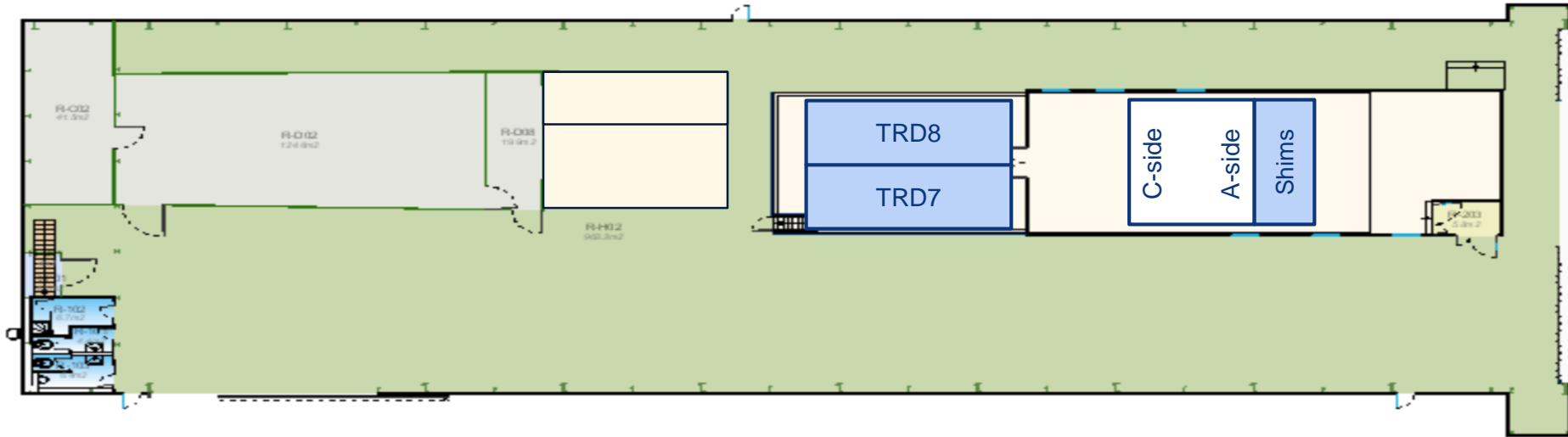

Day-by-day sequence w29



UX25 activities w29 – Mon 15 Jul 2019

Move TPC laser onto platform (Borge)

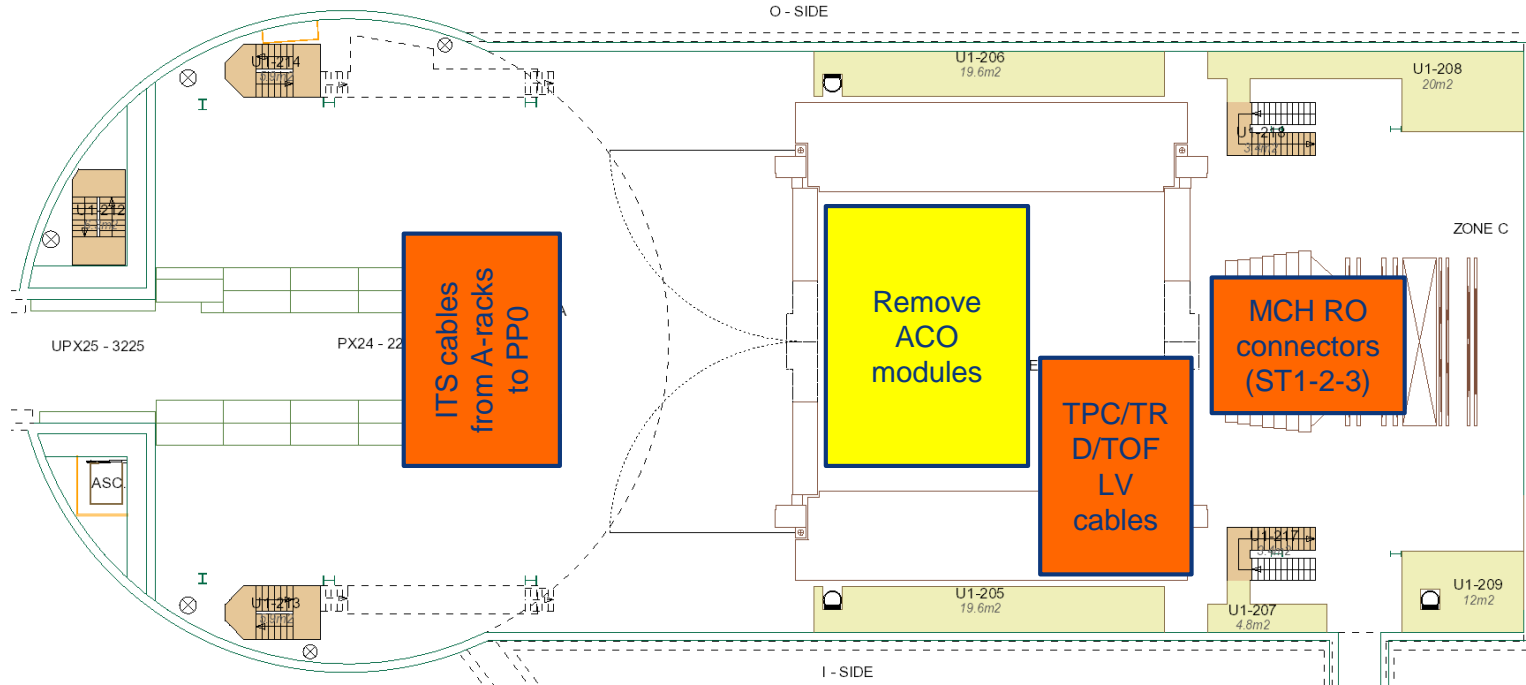

Miniframe activities w29 – Mon 15 Jul 2019

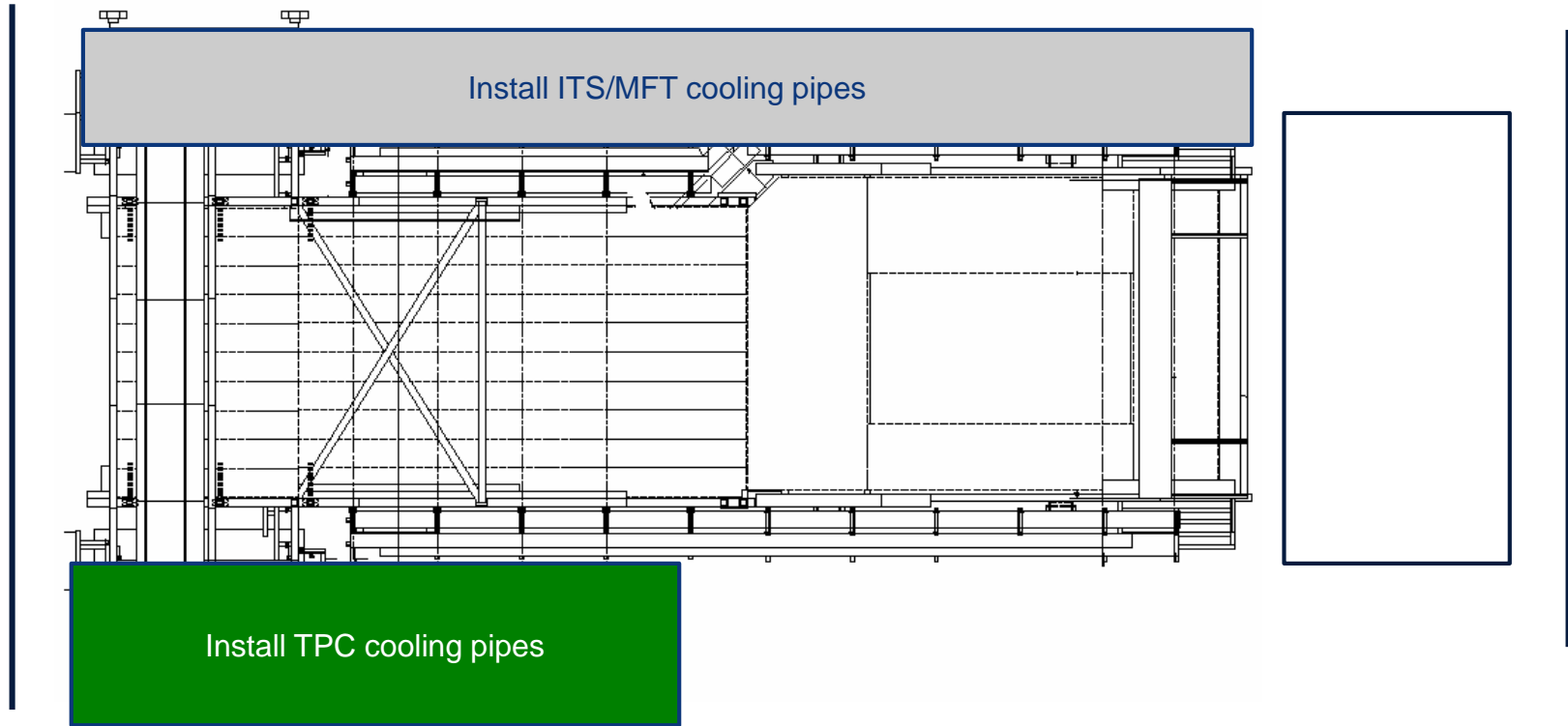

SXL2 activities w29 – Mon 15 Jul 2019

Wrap blocks for TPC laser

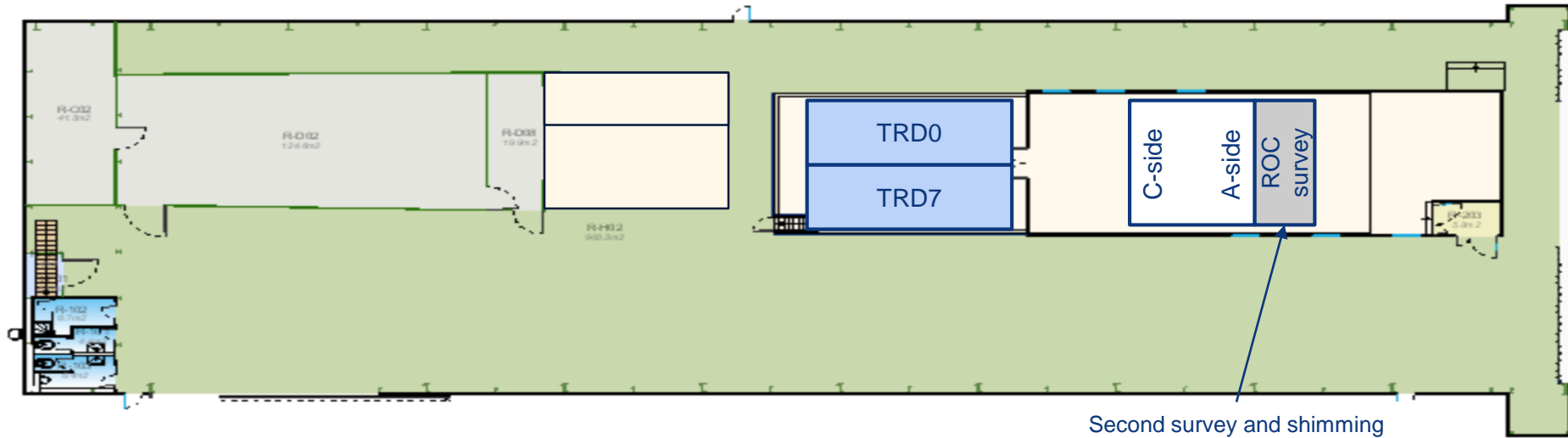

UX25 activities w29 – Tue 16 Jul 2019

Move TPC laser onto platform (Borge)

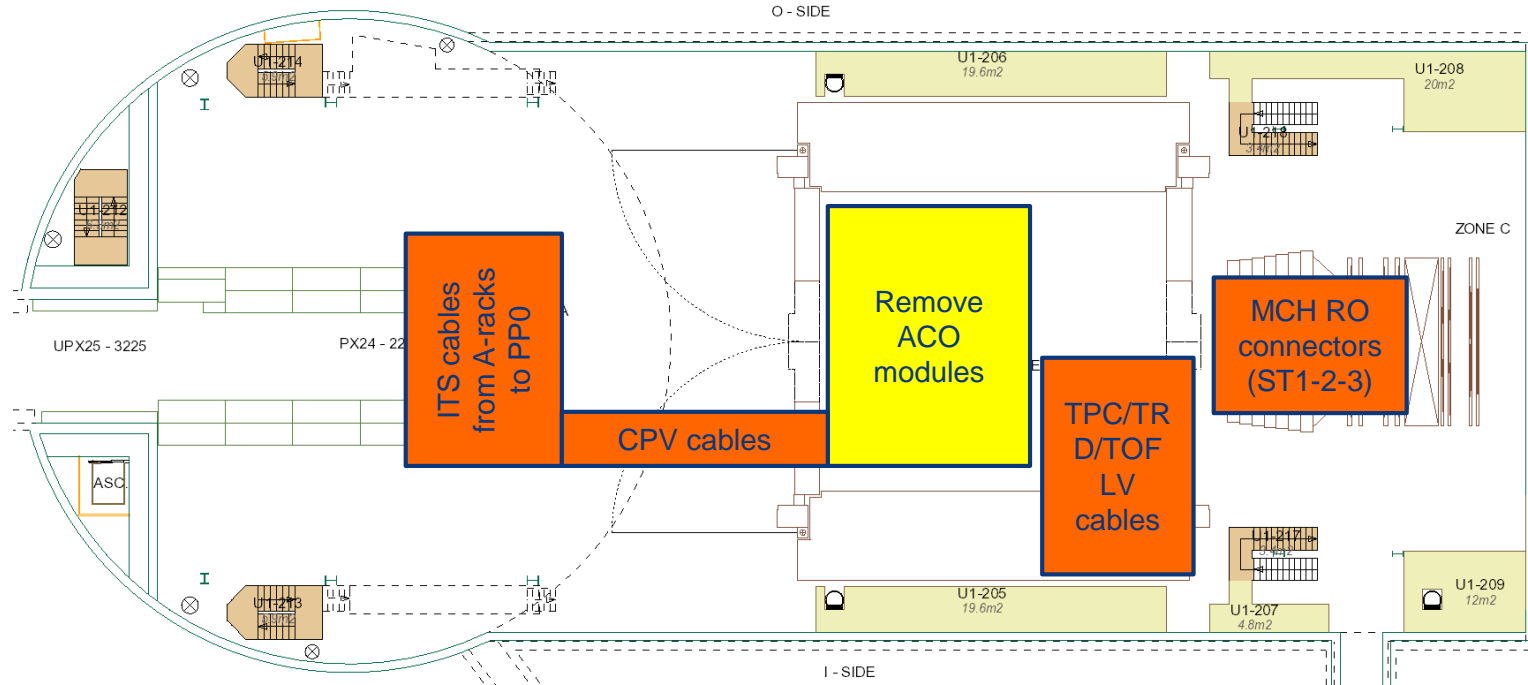

Miniframe activities w29 – Tue 16 Jul 2019

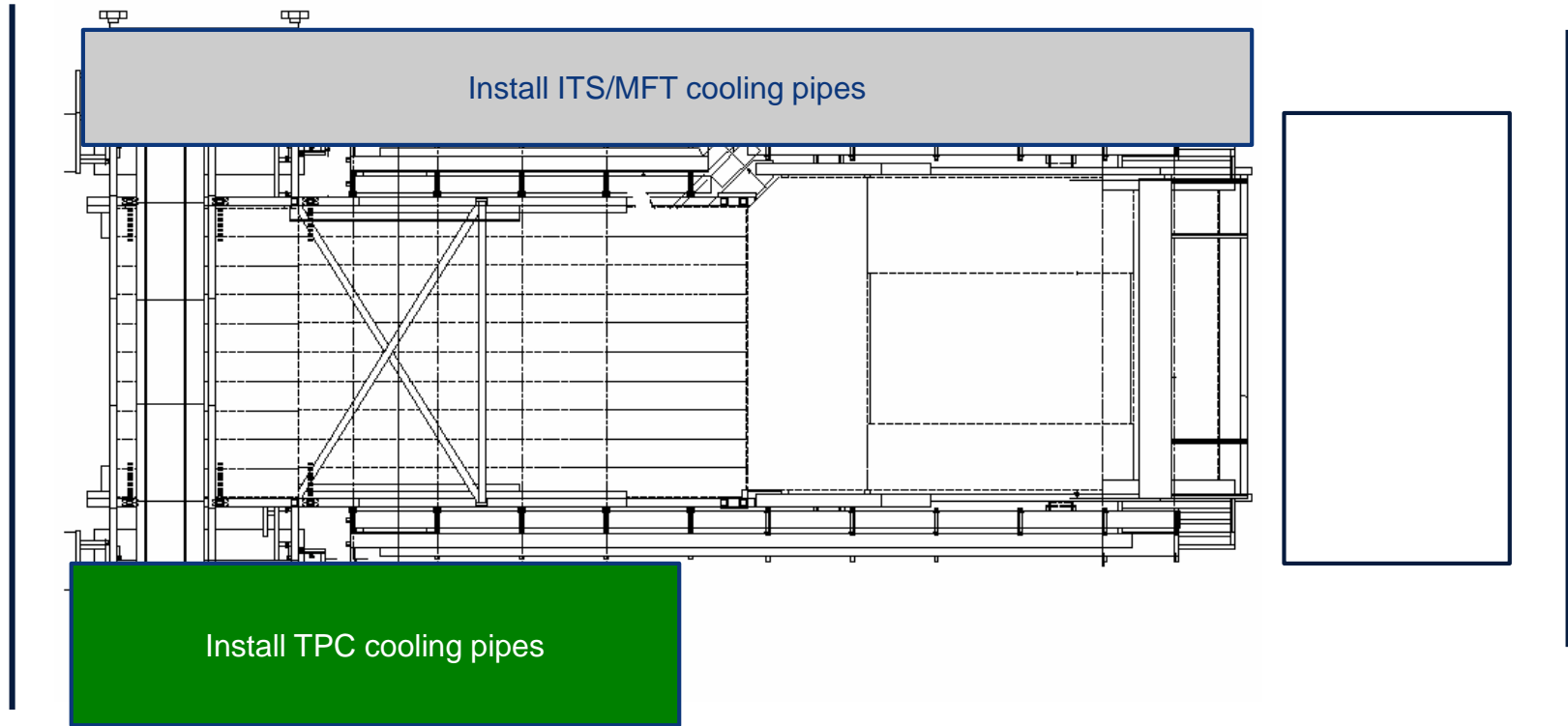

SXL2 activities w29 – Tue 16 Jul 2019

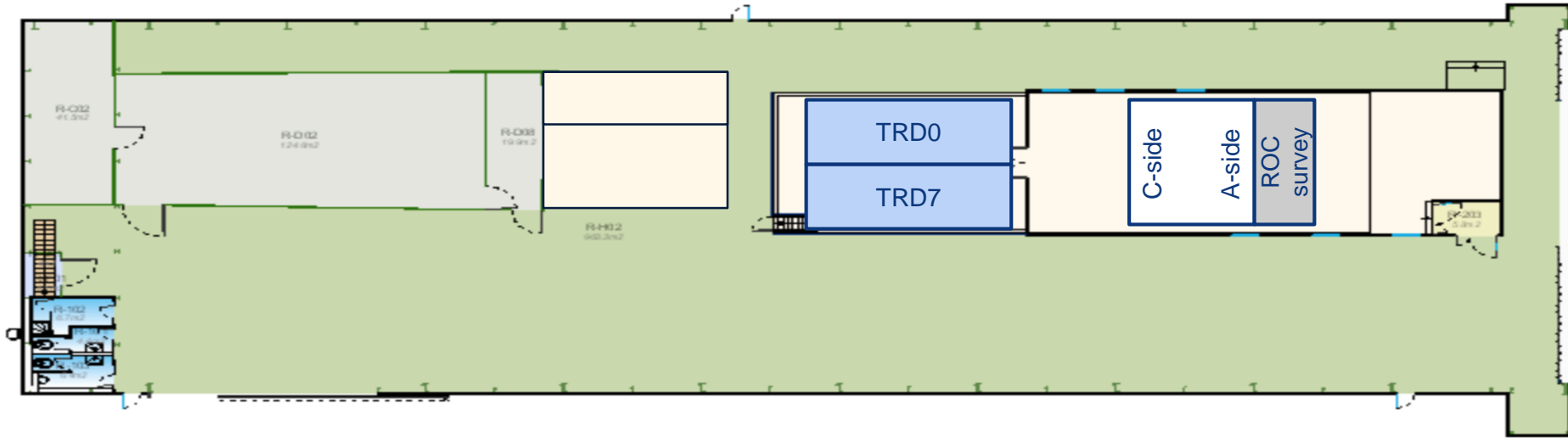

UX25 activities w29 – Wed 17 Jul 2019

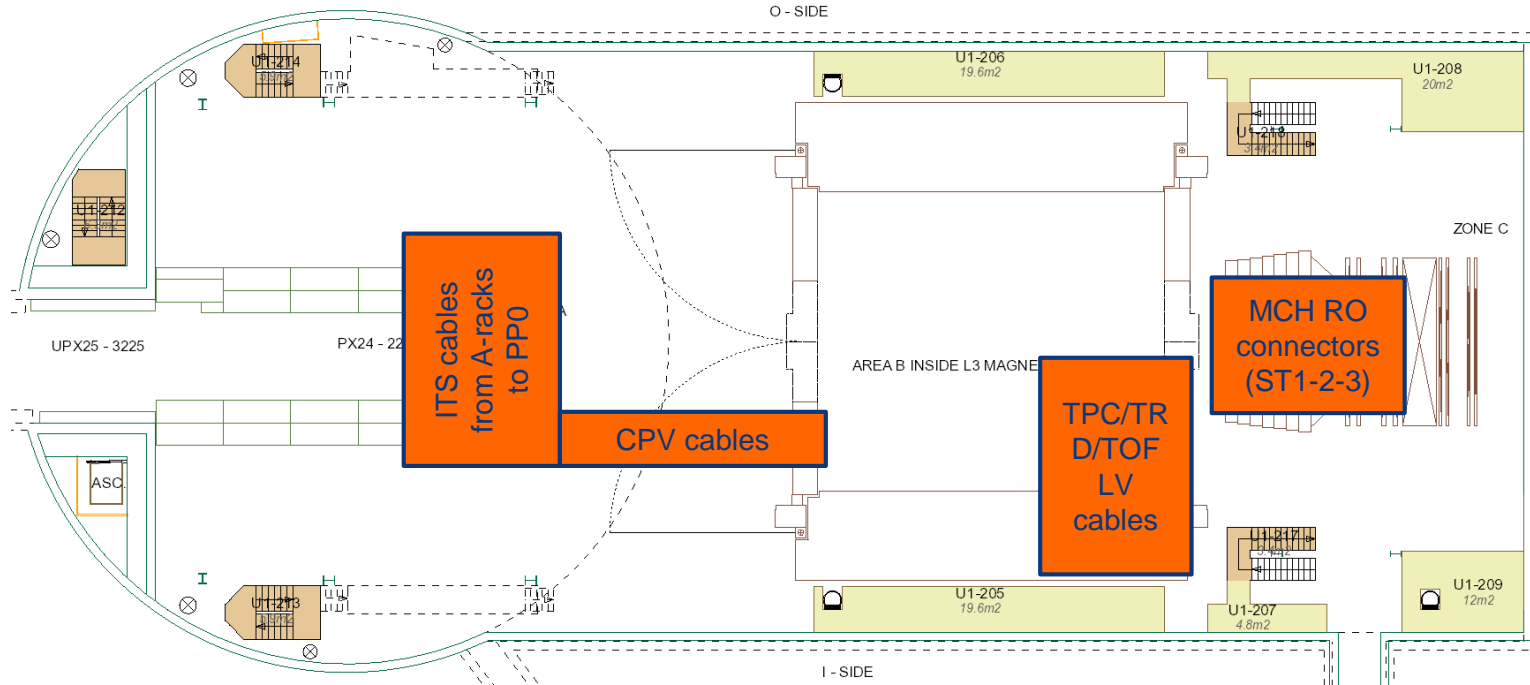

Miniframe activities w29 – Wed 17 Jul 2019

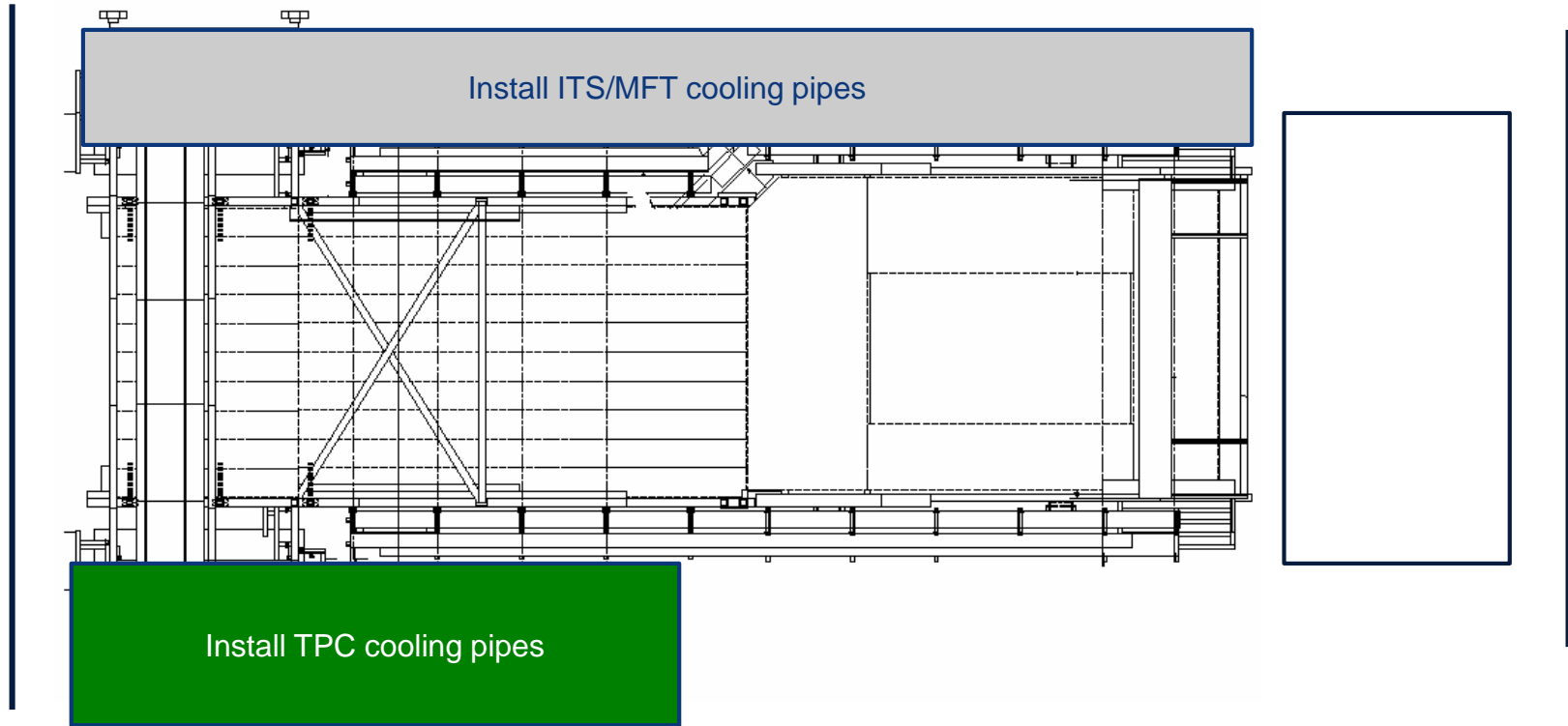

SXL2 activities w29 – Wed 17 Jul 2019

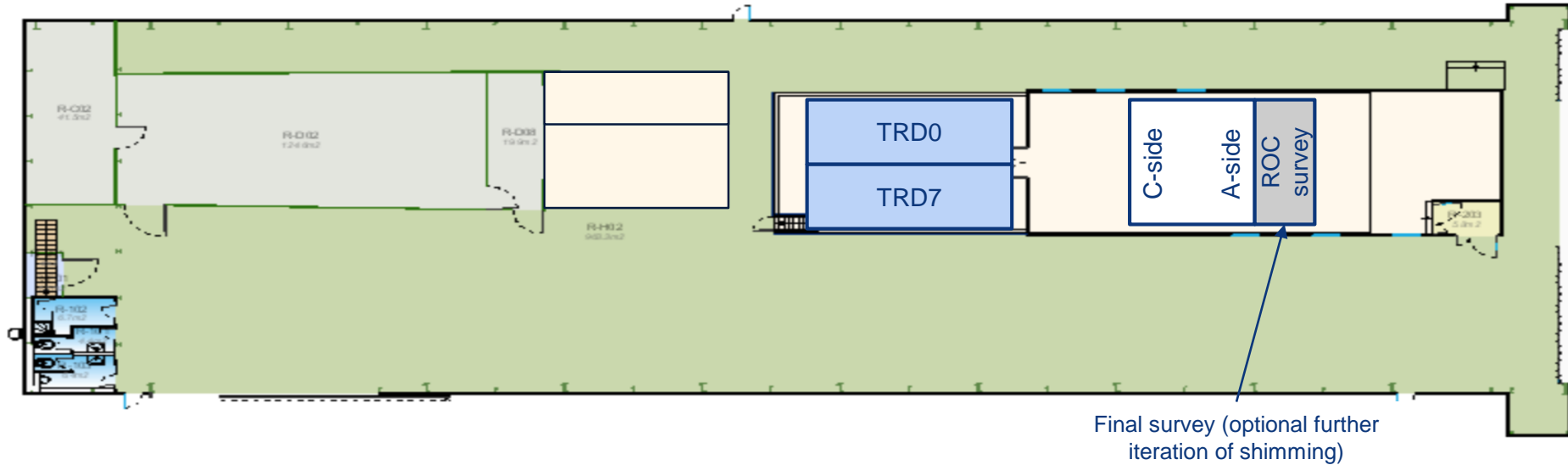

UX25 activities w29 – Thu 18 Jul 2019

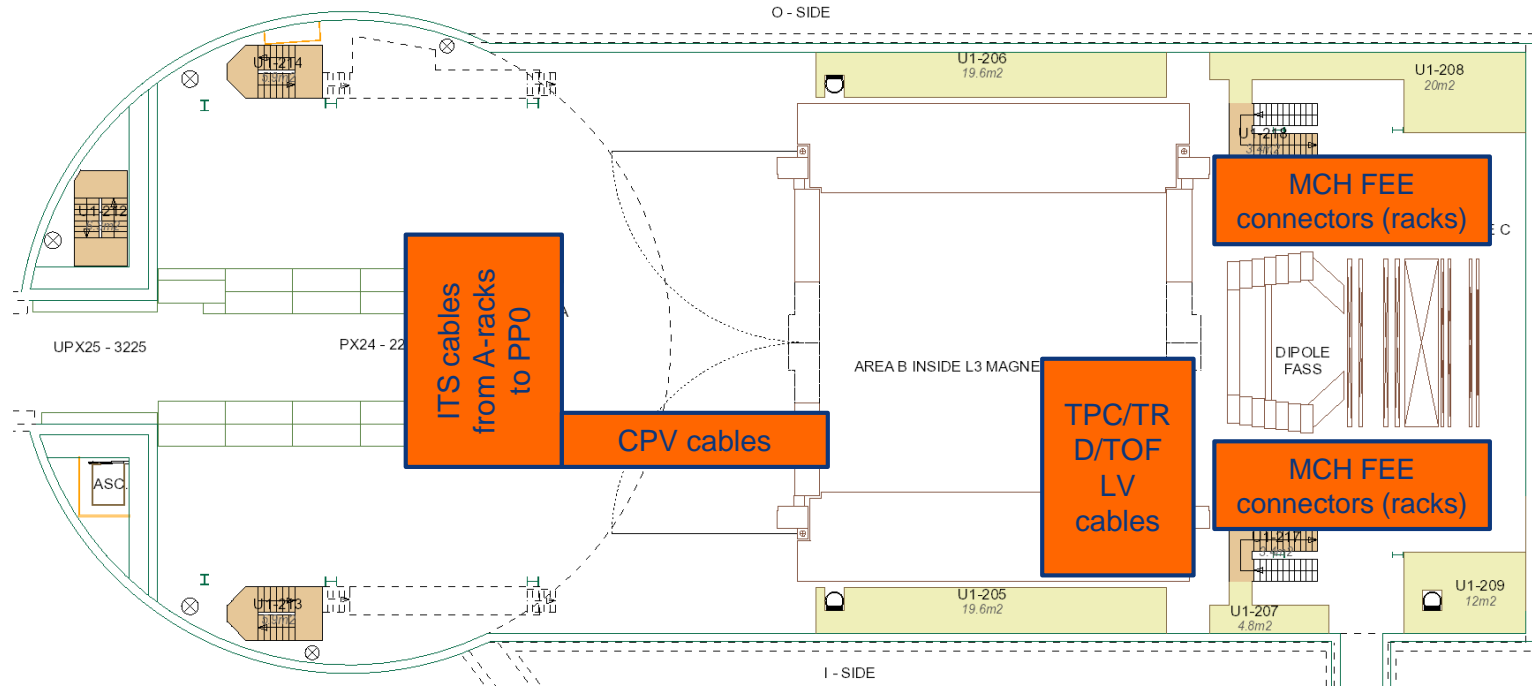

Miniframe activities w29 – Thu 18 Jul 2019

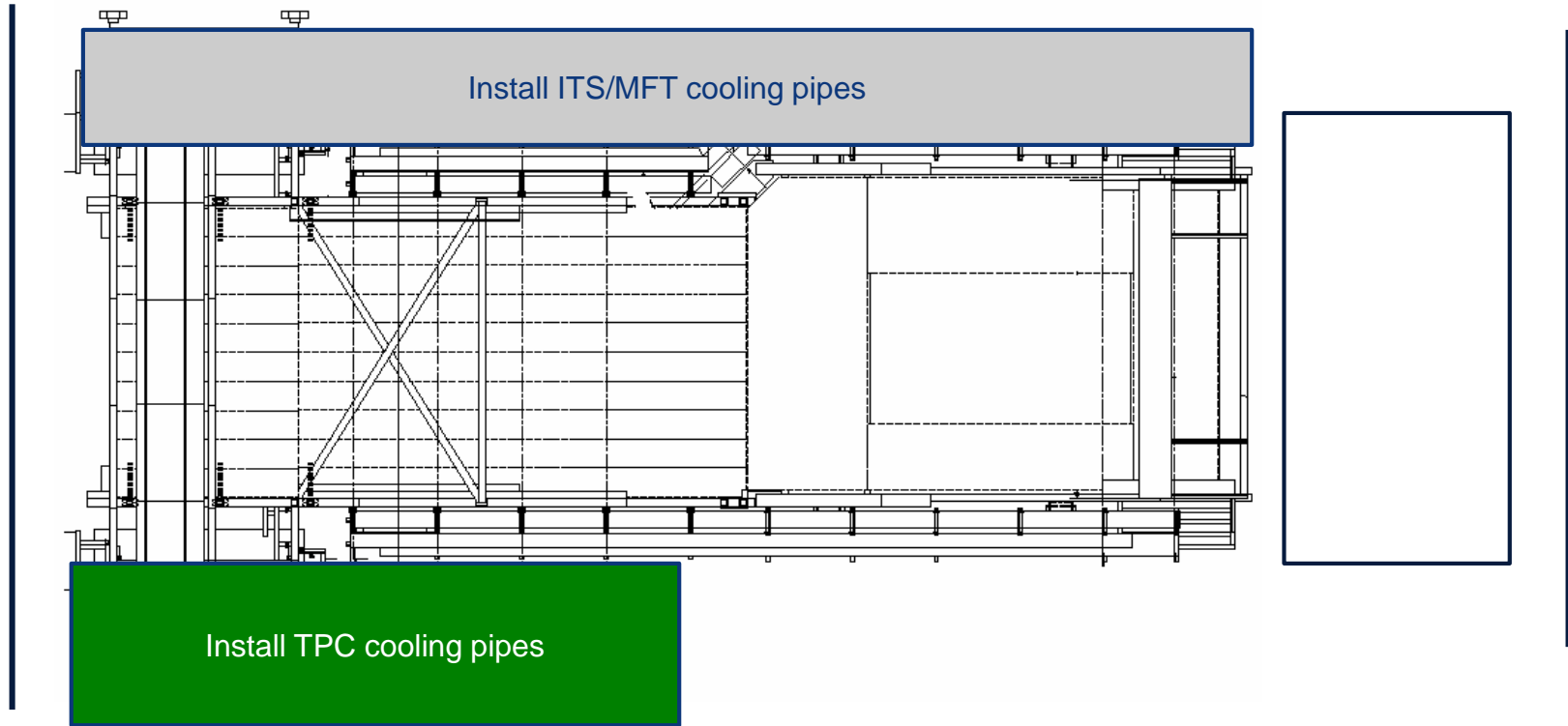

SXL2 activities w29 – Thu 18 Jul 2019

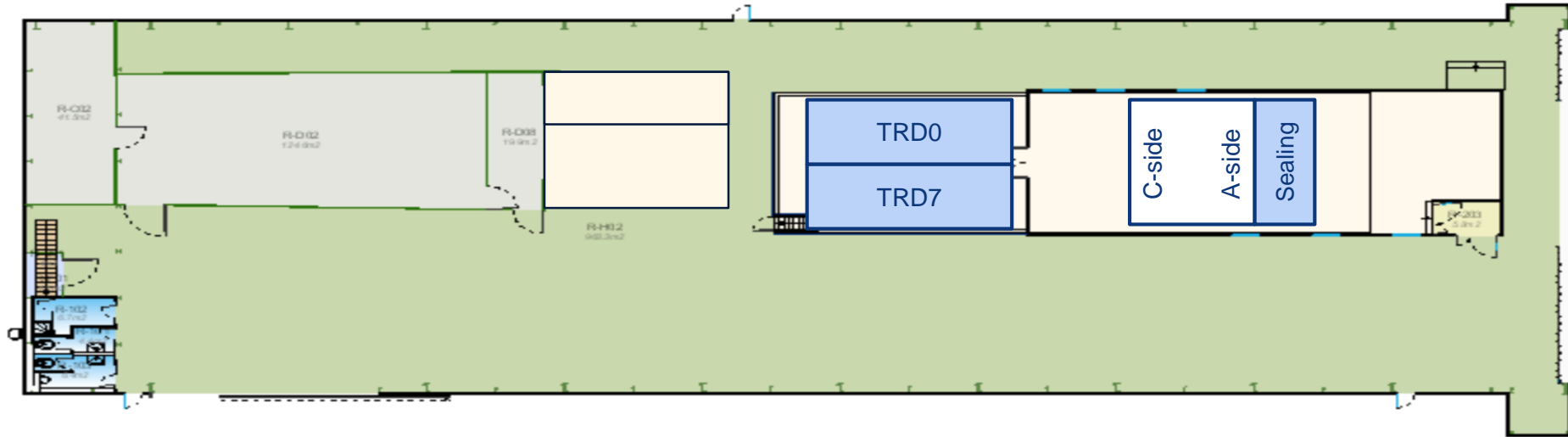

UX25 activities w29 – Fri 19 Jul 2019

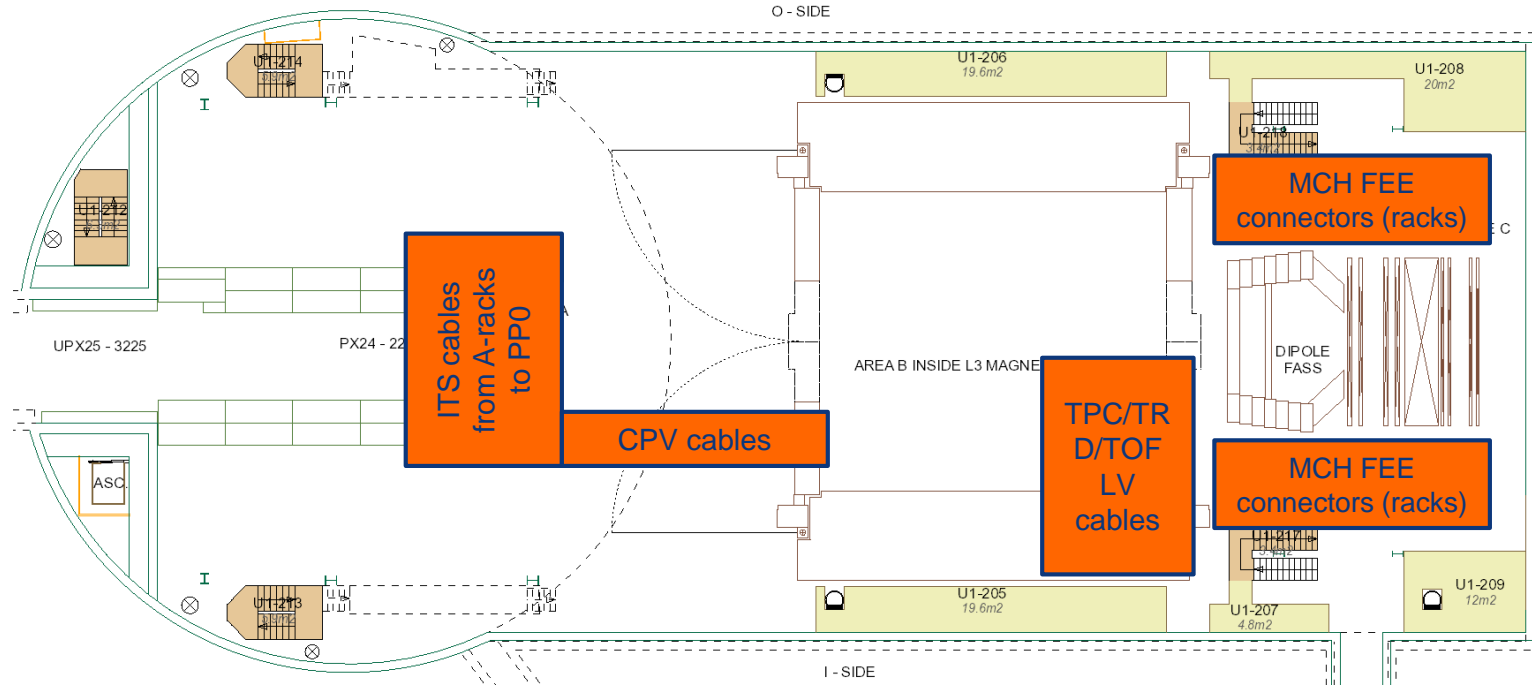

Miniframe activities w29 – Fri 19 Jul 2019

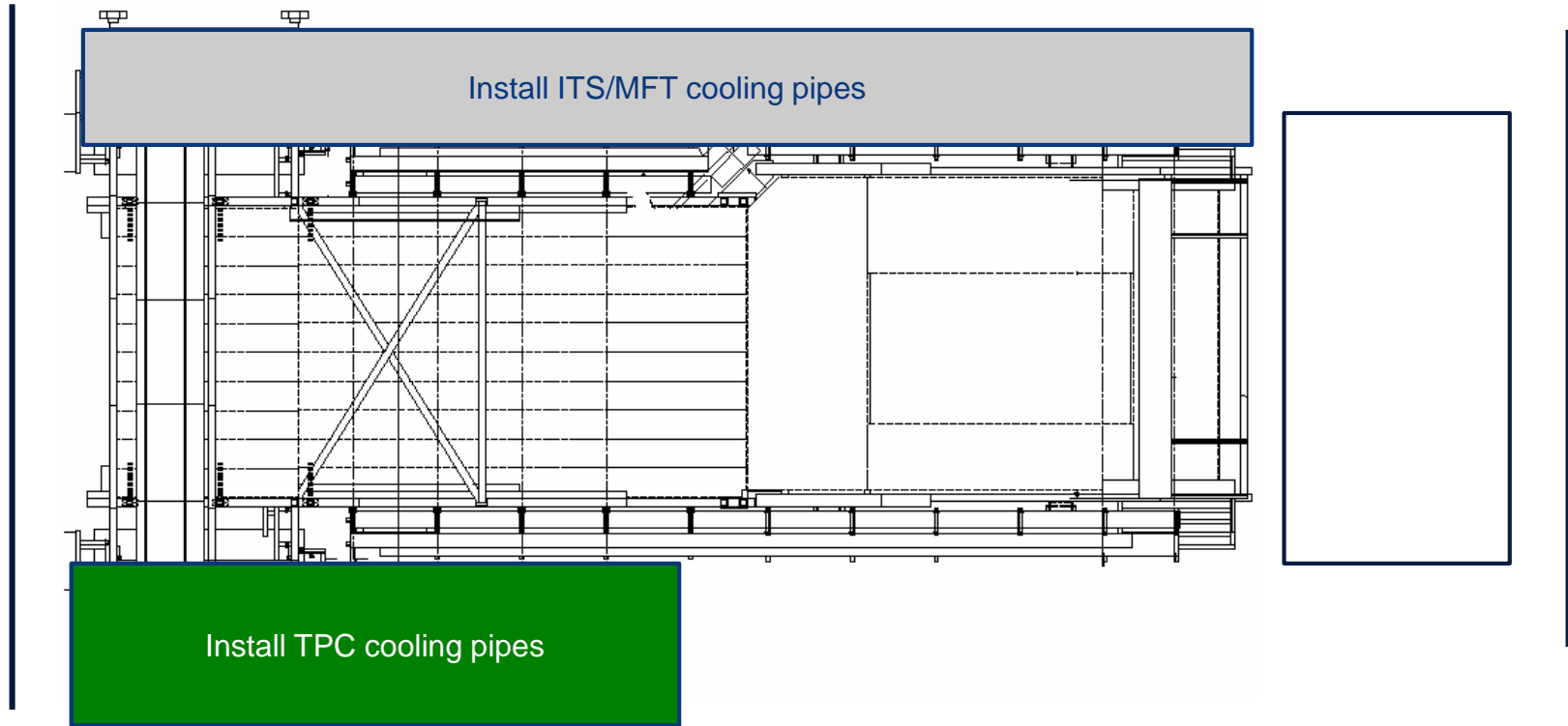

SXL2 activities w29 – Fri 19 Jul 2019

Topnet: clean cleanroom roof (rent special nacelle)

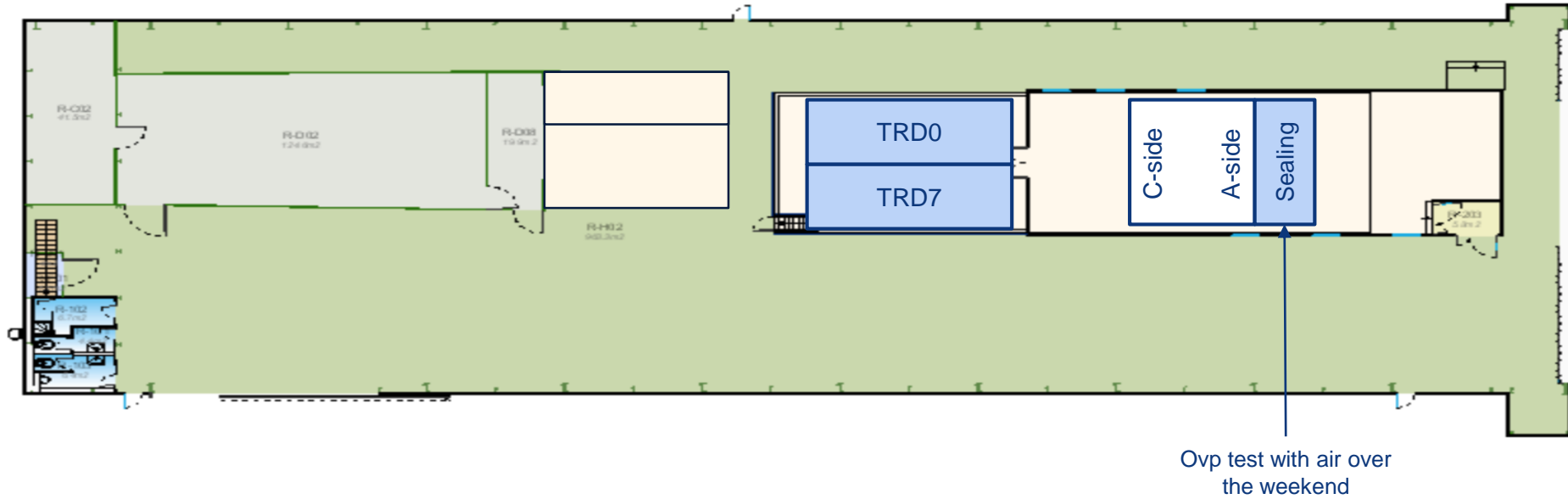

Day-by-day sequence w30

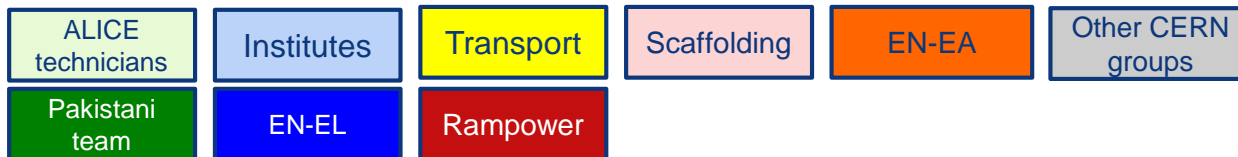

UX25 activities w30 – Mon 22 Jul 2019

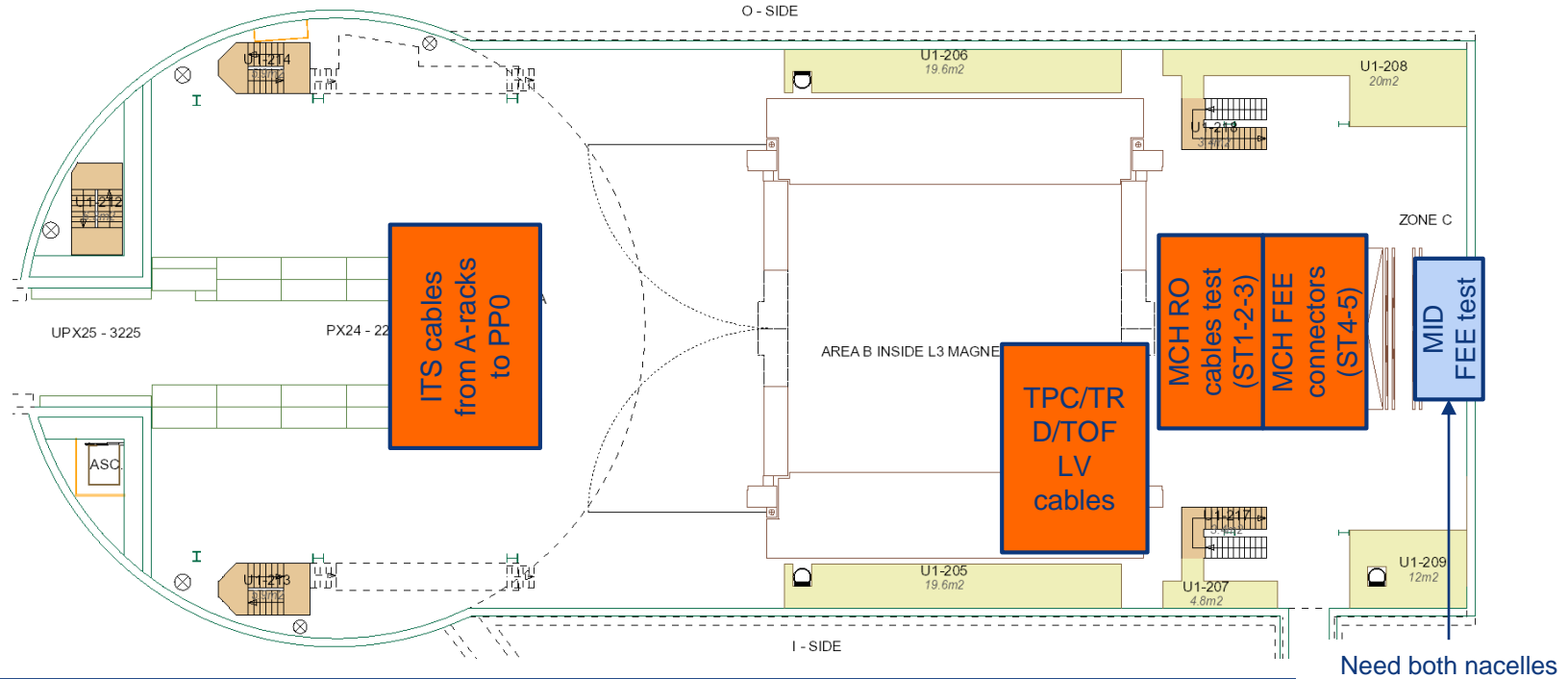

Miniframe activities w30 – Mon 22 Jul 2019

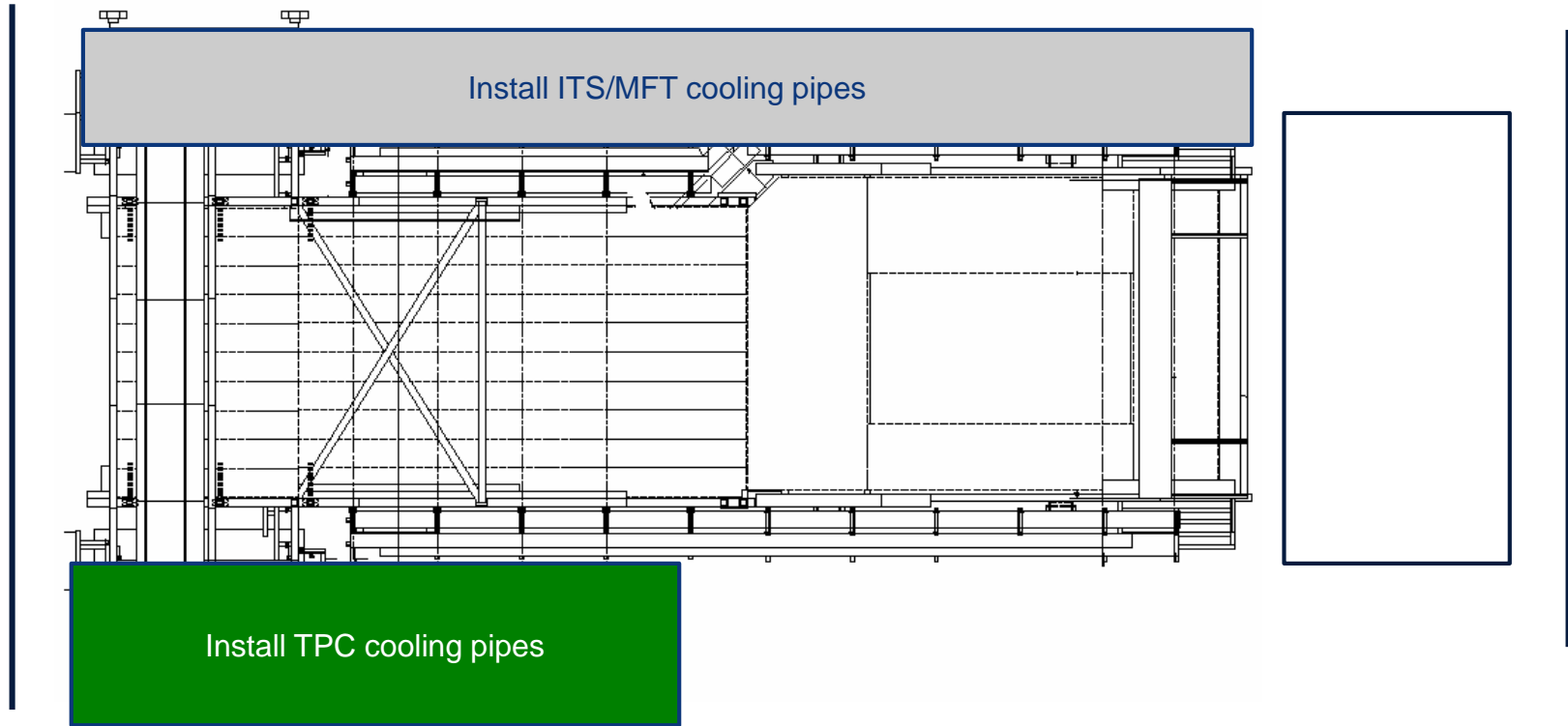

SXL2 activities w30 – Mon 22 Jul 2019

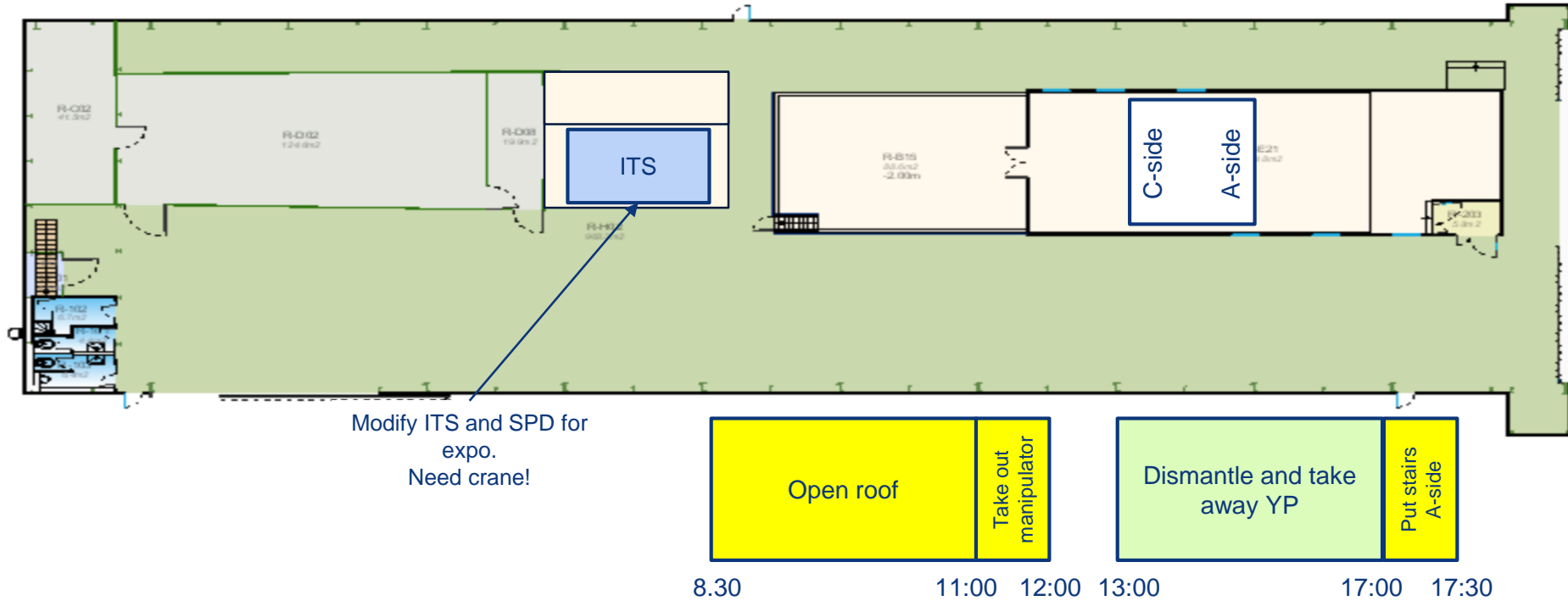

UX25 activities w30 – Tue 23 Jul 2019

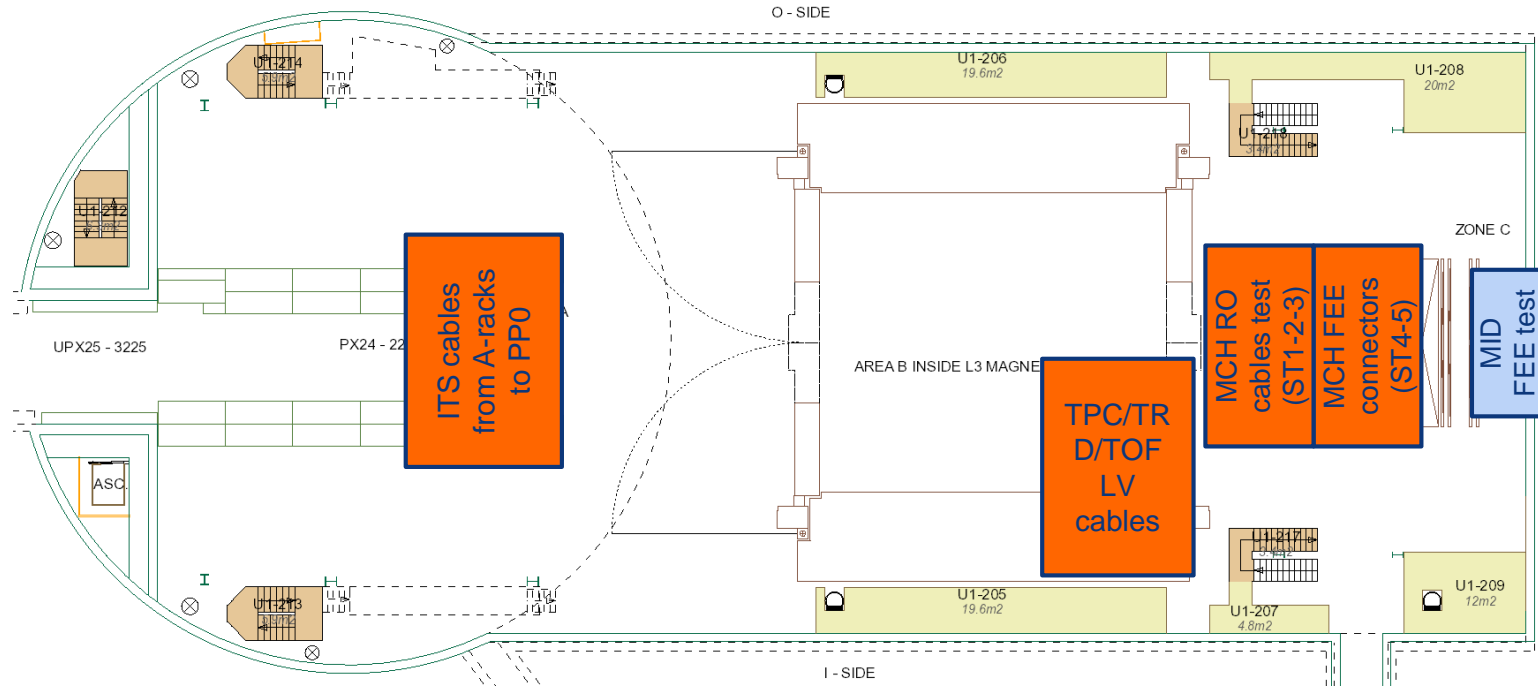

Miniframe activities w30 – Tue 23 Jul 2019

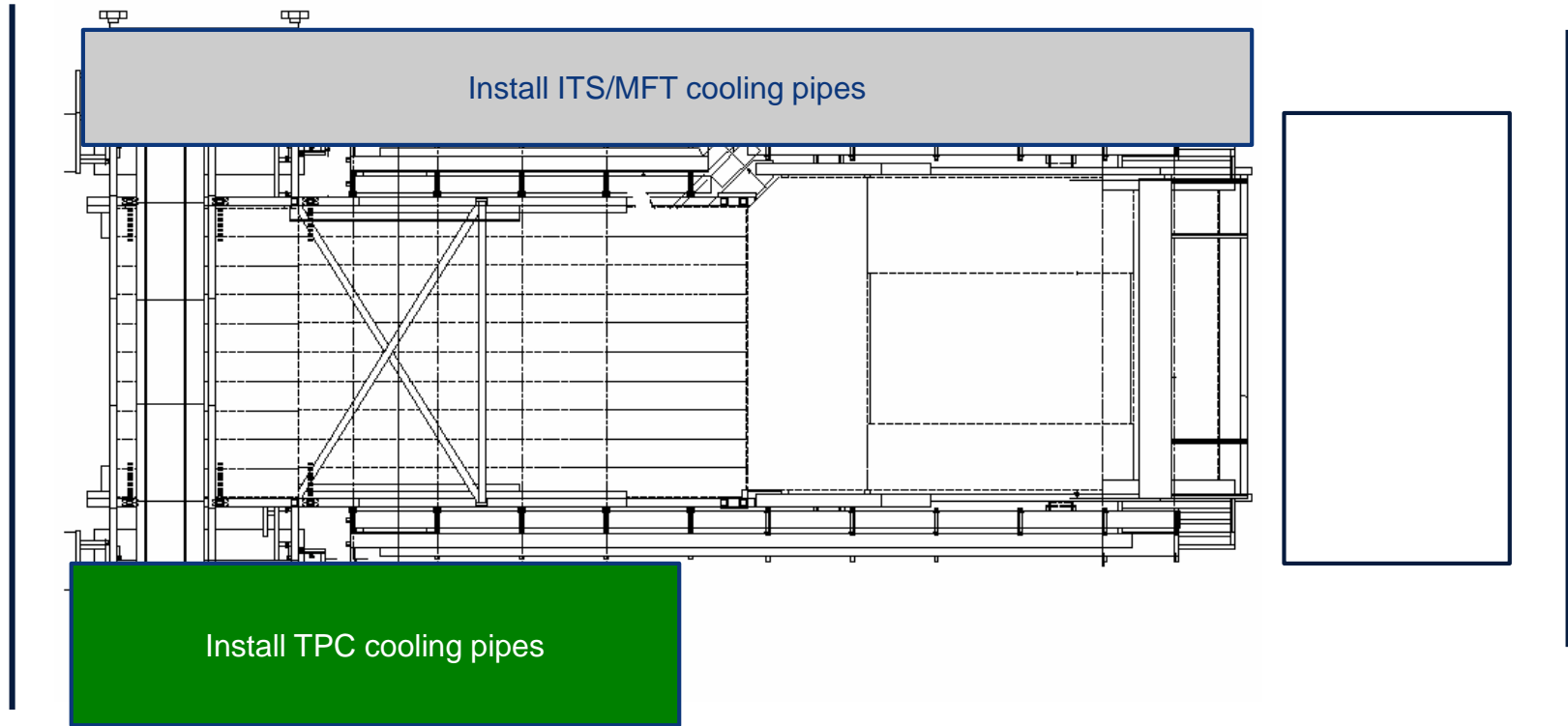

SXL2 activities w30 – Tue 23 Jul 2019

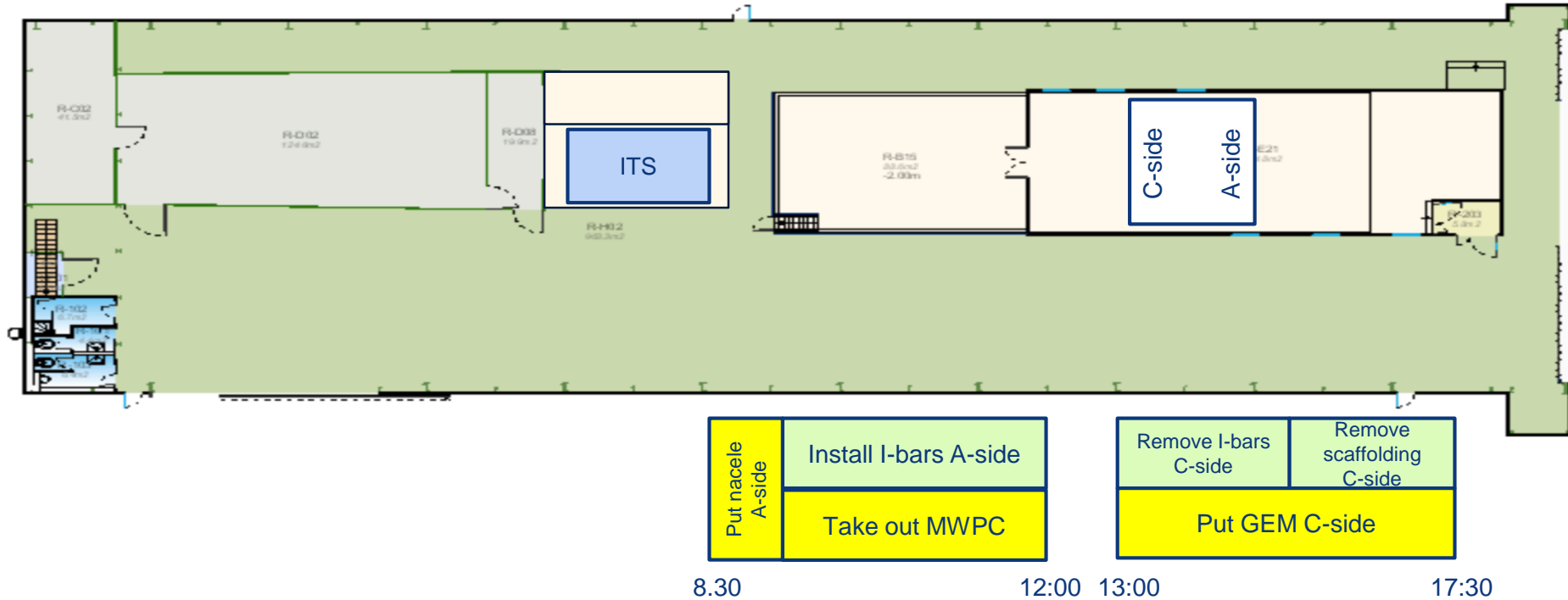

UX25 activities w30 – Wed 24 Jul 2019

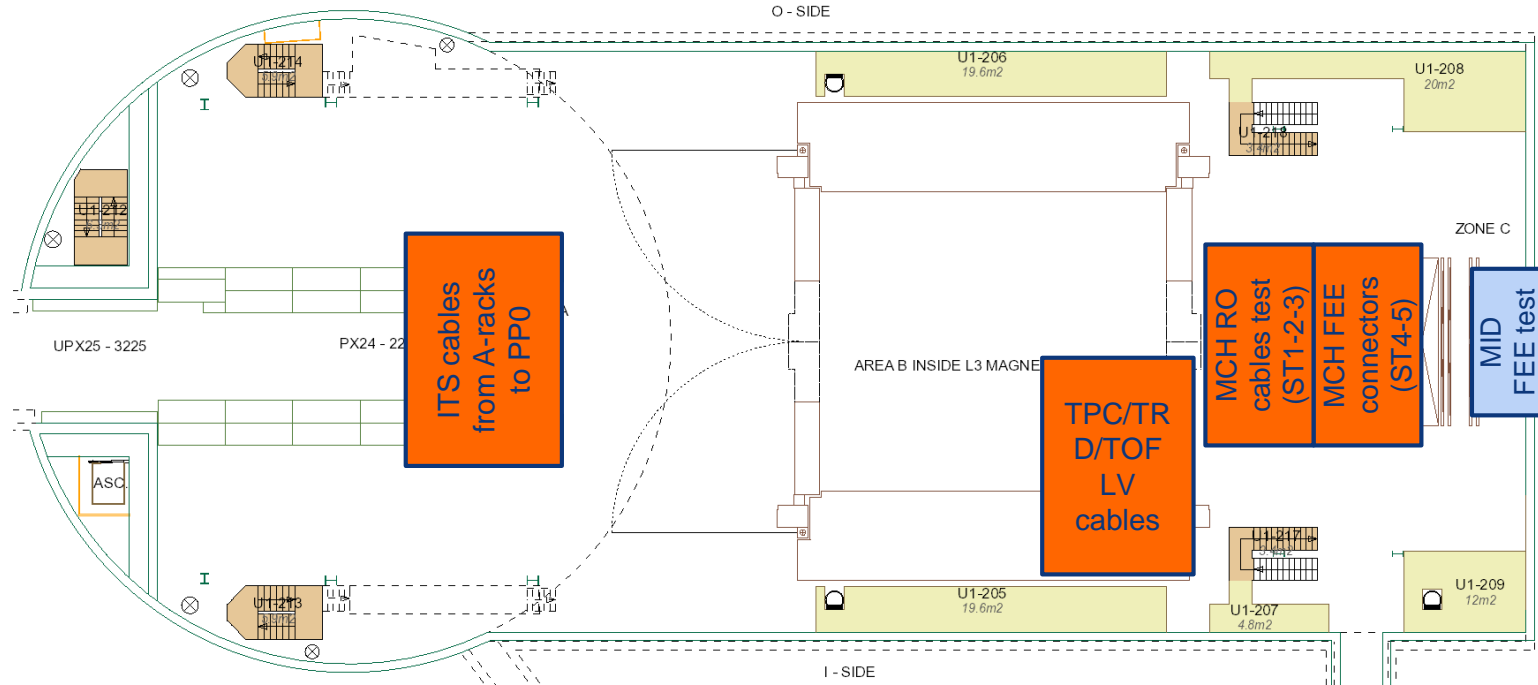

Miniframe activities w30 – Wed 24 Jul 2019

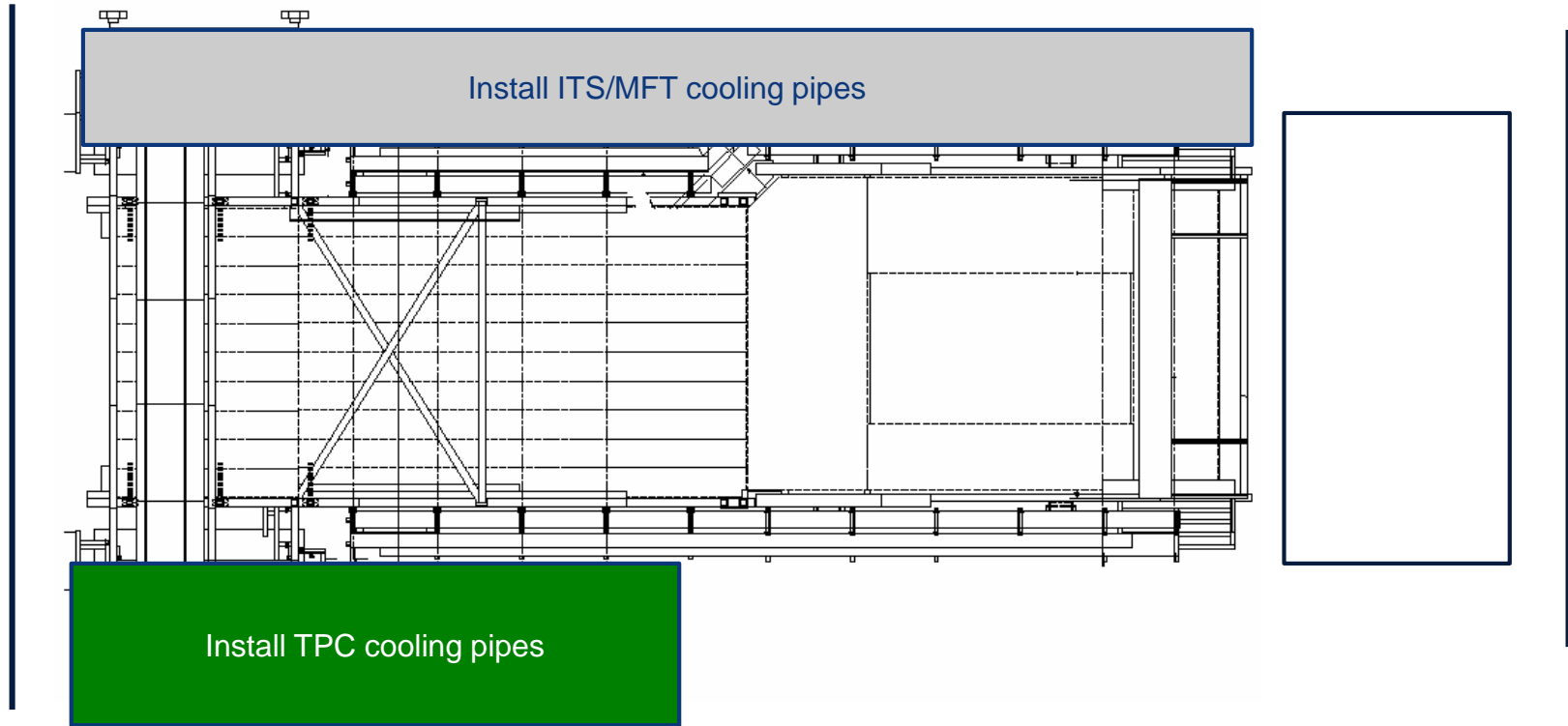

SXL2 activities w30 – Wed 24 Jul 2019

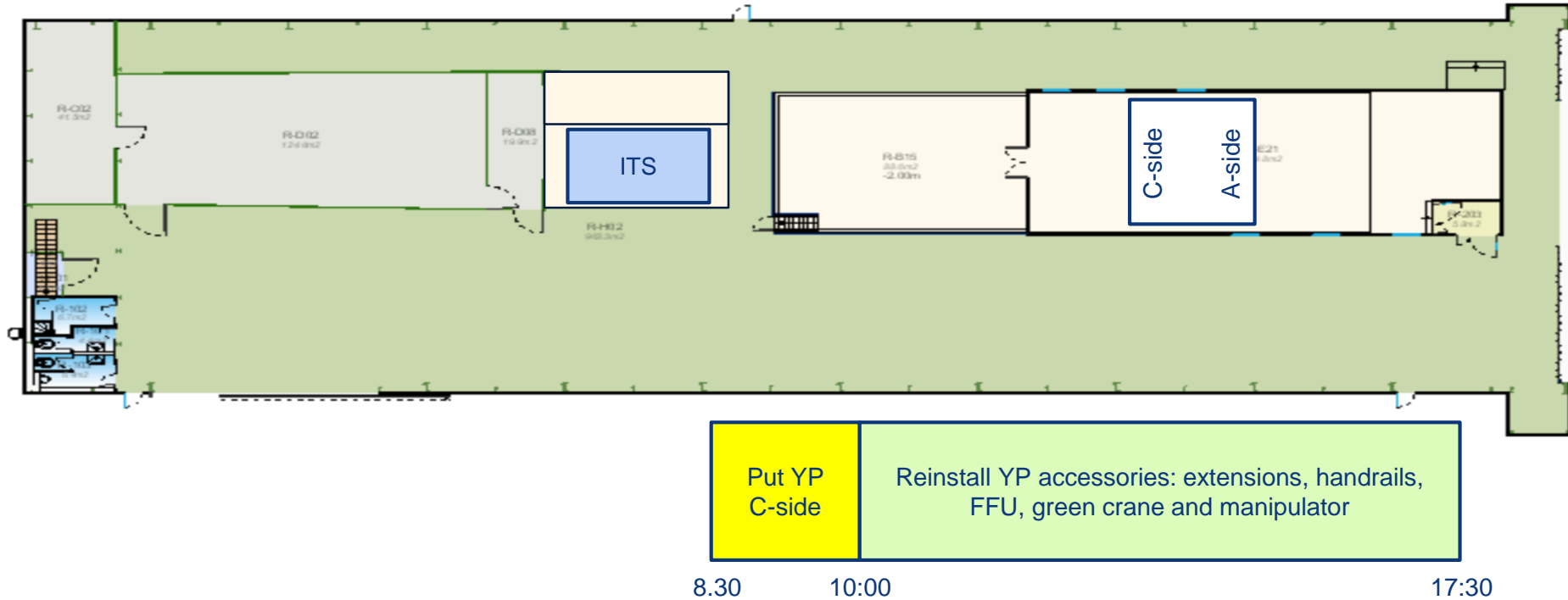

UX25 activities w30 – Thu 25 Jul 2019

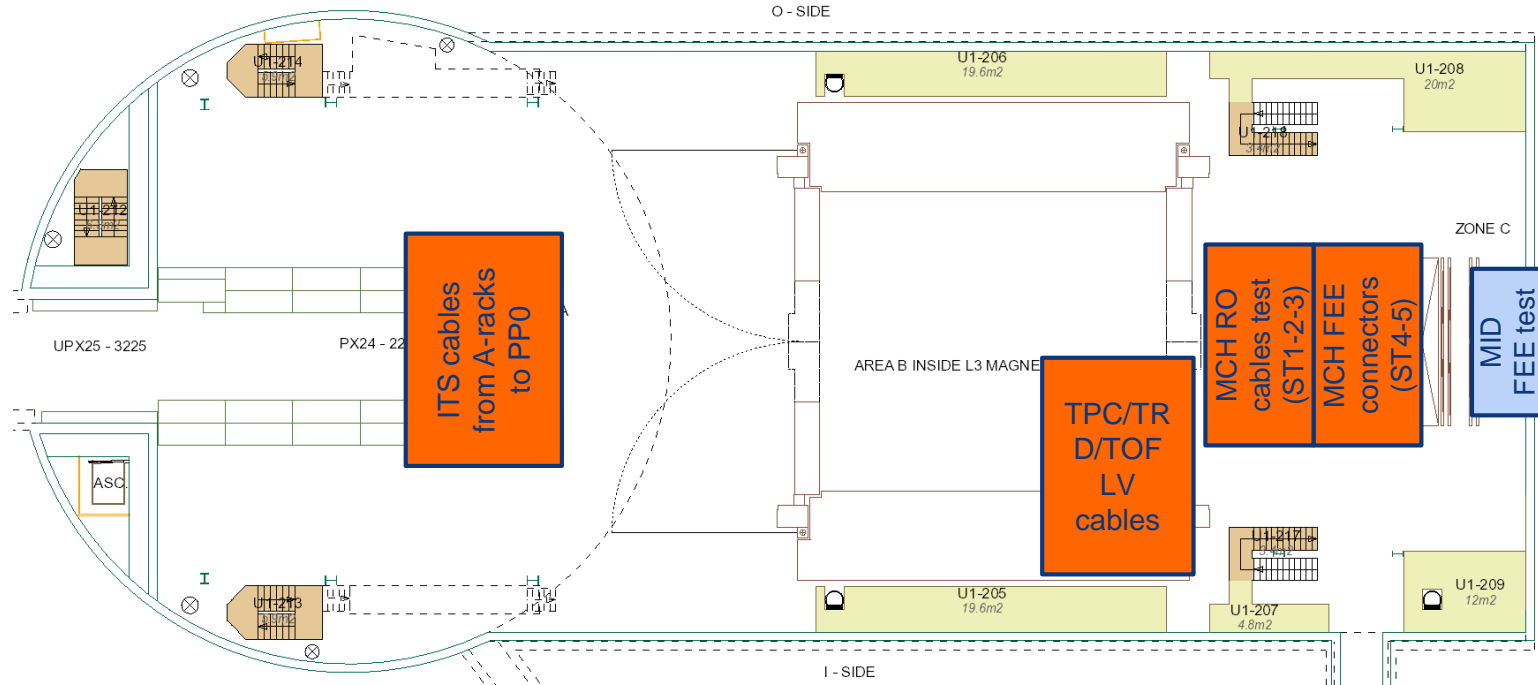

Miniframe activities w30 – Thu 25 Jul 2019

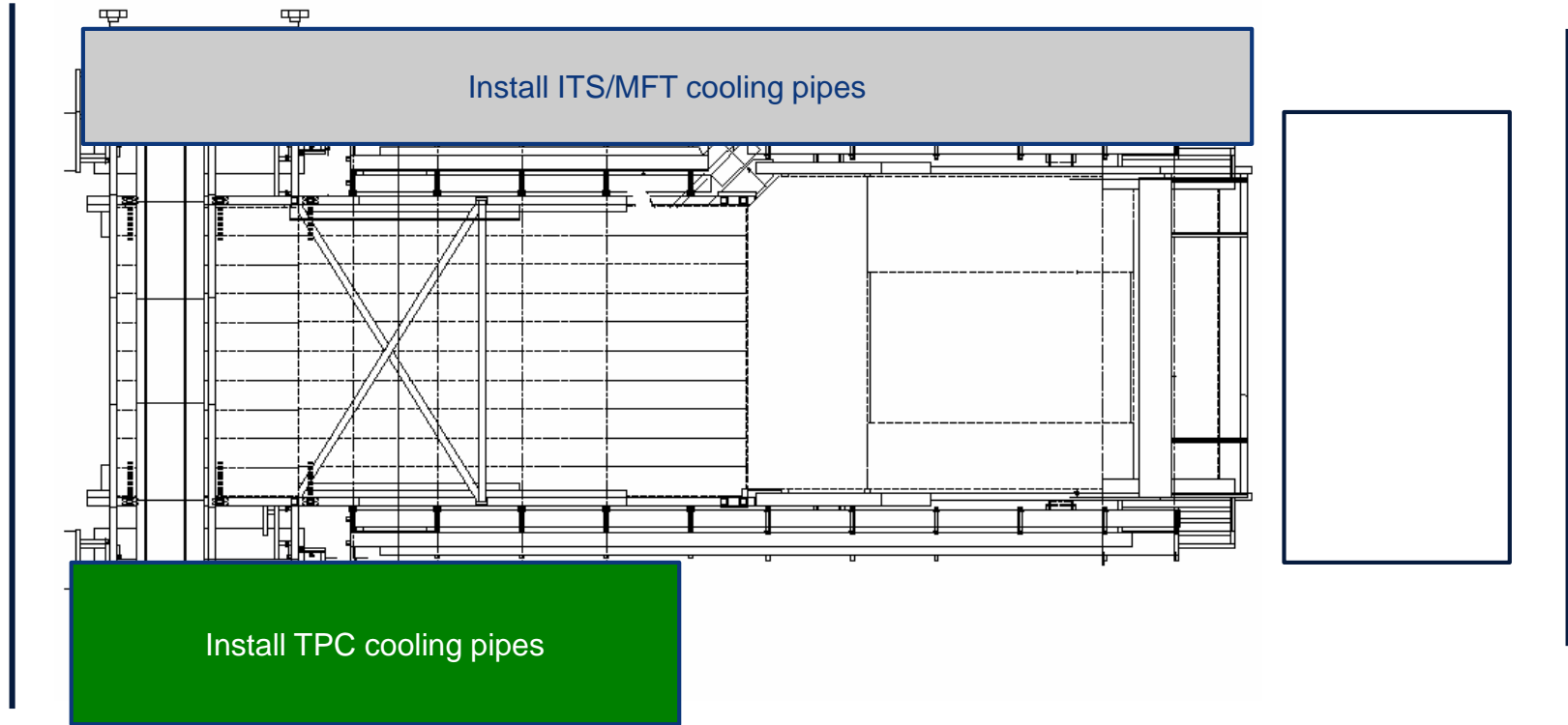

SXL2 activities w30 – Thu 25 Jul 2019

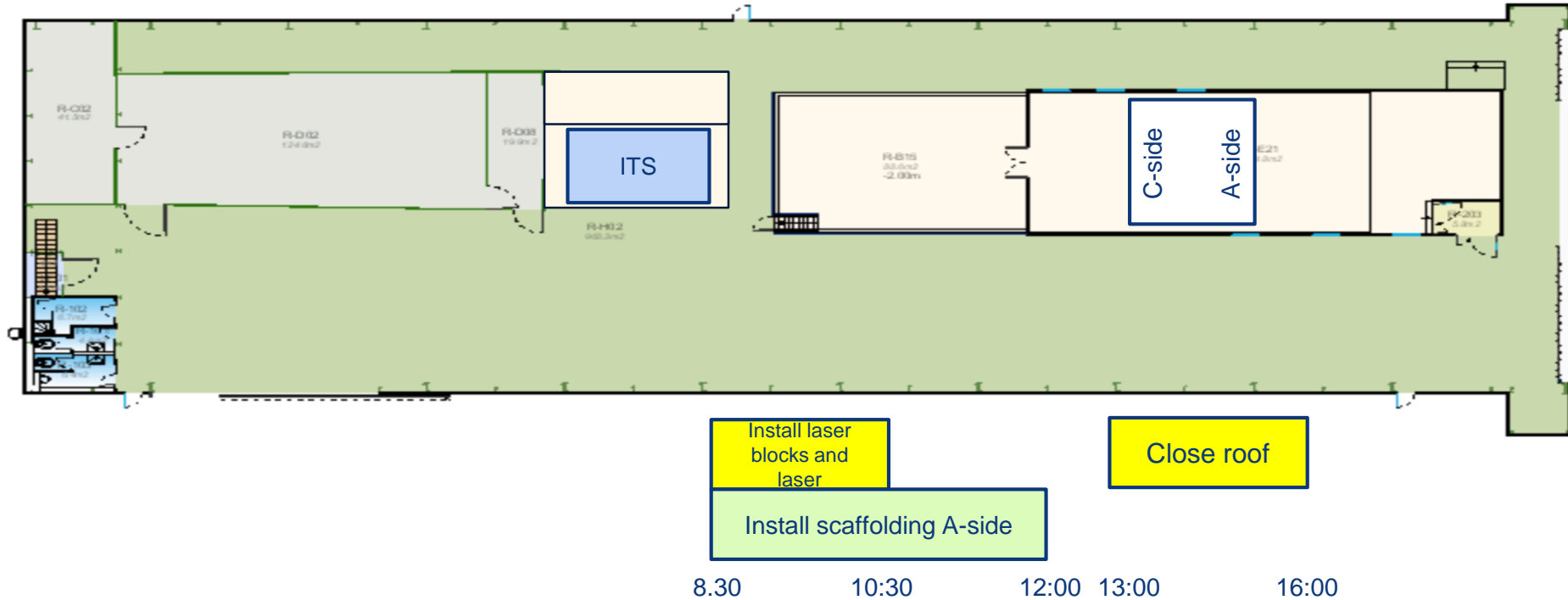

UX25 activities w30 – Fri 26 Jul 2019

Lift maintenance (AS-724): no access to UX25 from Friday 26.7 12:00 to Saturday 27.7 18:00

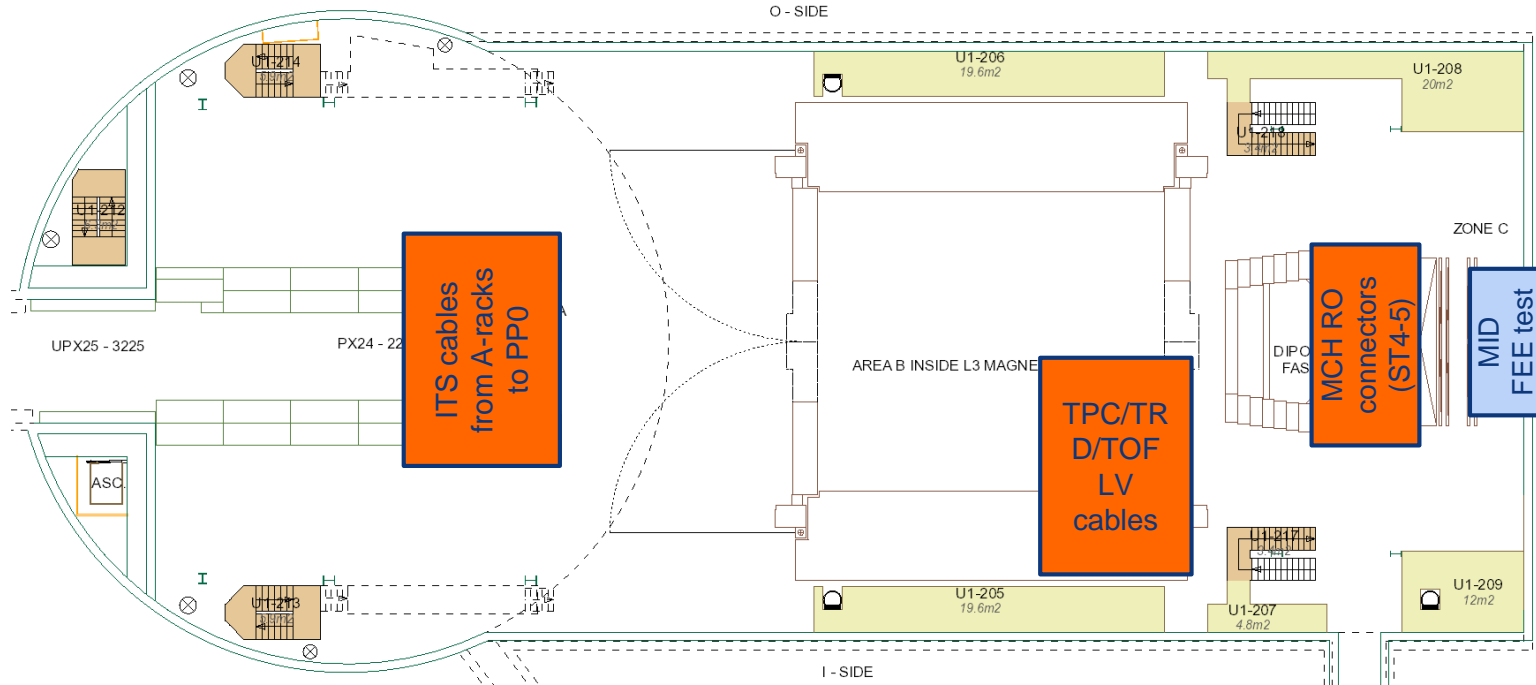

Miniframe activities w30 – Fri 26 Jul 2019

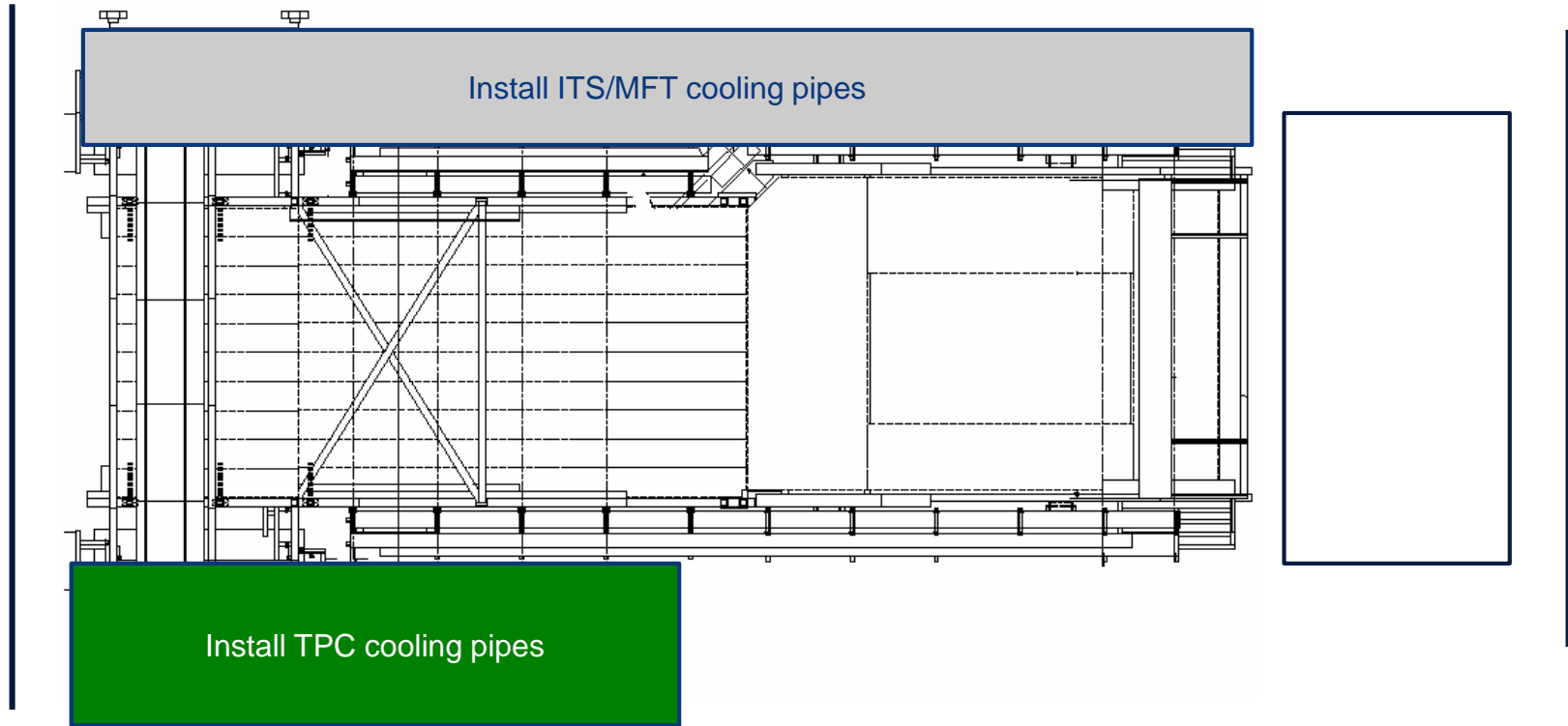

SXL2 activities w30 – Fri 26 Jul 2019

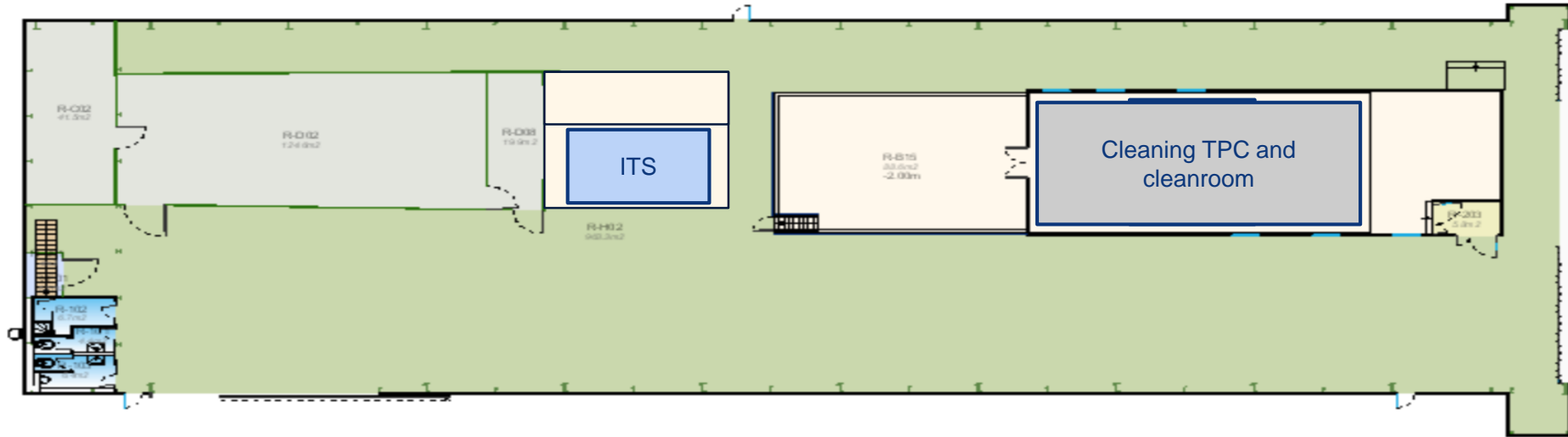

AOB

- No LS2 planning meeting / daily meetings next week