

LS2 planning meeting

A.Tauro

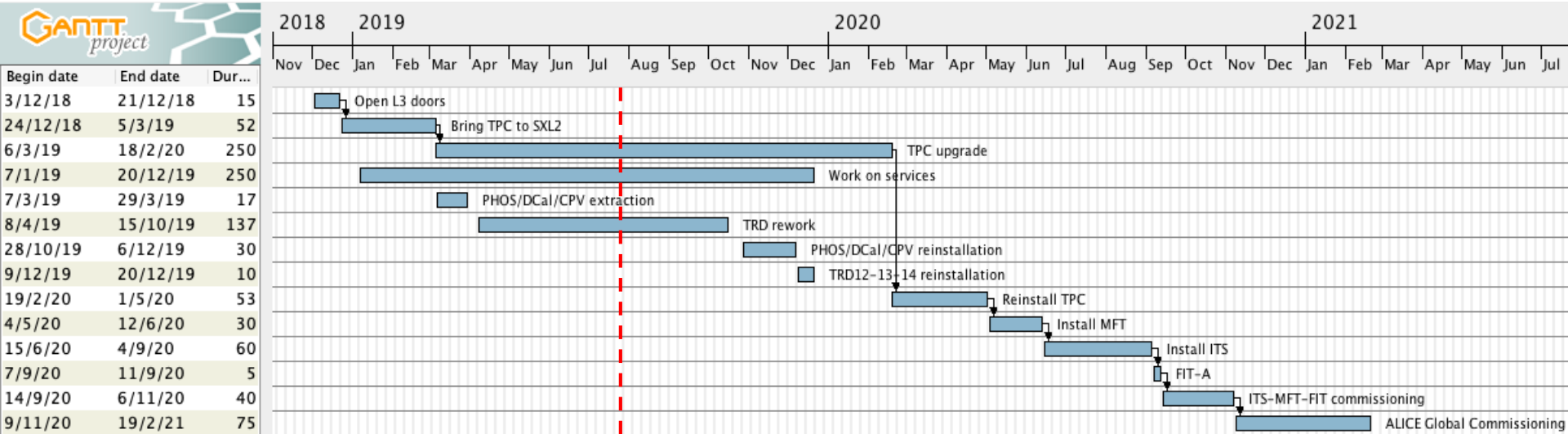

LS2 master plan (v31)



EN-EL interventions

- Test secours (10 min): 19 Dec 2019 from 8:00 AM to 11:00 AM
- 18kV, 3.3kV and LV network maintenance:
 - Mon 20 to Wed 22 Jan 2020: 3 days no general services - **no access on site (both surface and underground)**
 - Thu 23 to Fri 24 Jan 2020: 2 days "Limited access" → details to be worked out
- AUG on Monday 27 January 2020 - **no access on site (both surface and underground)**
- Auto transfer test: 27-29 Apr 2020
- BIW test: 5 and 6 Oct 2020 from 18:00 to 00:00 – **no access underground**

EN-CV interventions

- **Big maintenance:**
 - SF: from Nov 2019 to mid Jan 2020. NO impact on ALICE as both magnets will be OFF.
 - UW: **stop UX mixed water** for 2 days in week 40/2019 (October).
 - SU: various small perturbations + 1 day **stop all cooling UX** + 1 day **stop all cooling SXL2** in week 16/2020 (April).
- **Small maintenance:**
 - UW: from mid Aug 2020 to mid Sep 2020. **Stop mixed water UX** for 1 day in week 37/2020 (September).
 - SF+SU: weeks 45-47/2020: cleaning towers (stop SF 1 week) + 1 day **stop all cooling UX**.
- **Ventilation:**
 - SG2: w7/2019 - Done
 - Gas extraction: w8/2019 - Done
 - UX25 cavern: May 2020 (tbc)
 - MCH and MTG: Apr 2020 (tbc)
 - L3: Apr 2020 (tbc)
 - ITS: Apr 2020 (tbc)
- **Raw water:**
 - Test after Apr 2019. Short interruption (1 day), can be used tap water during the test.

UX access restrictions

- **No access from Friday 26th July 12:00 to Saturday 27th July 18:00 (lift intervention)**
- **No access to A-side on Friday 2nd August from 13:00 to 18:00 (evacuation TRD blocks)**
- **No access to A-side from 2nd to 4th September (open low-beta platform)**
- **No access to A-side from 18th to 20th September (close low-beta platform)**

TRD schedule

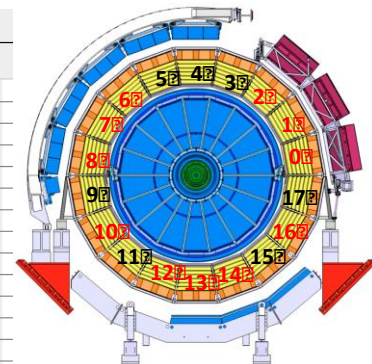
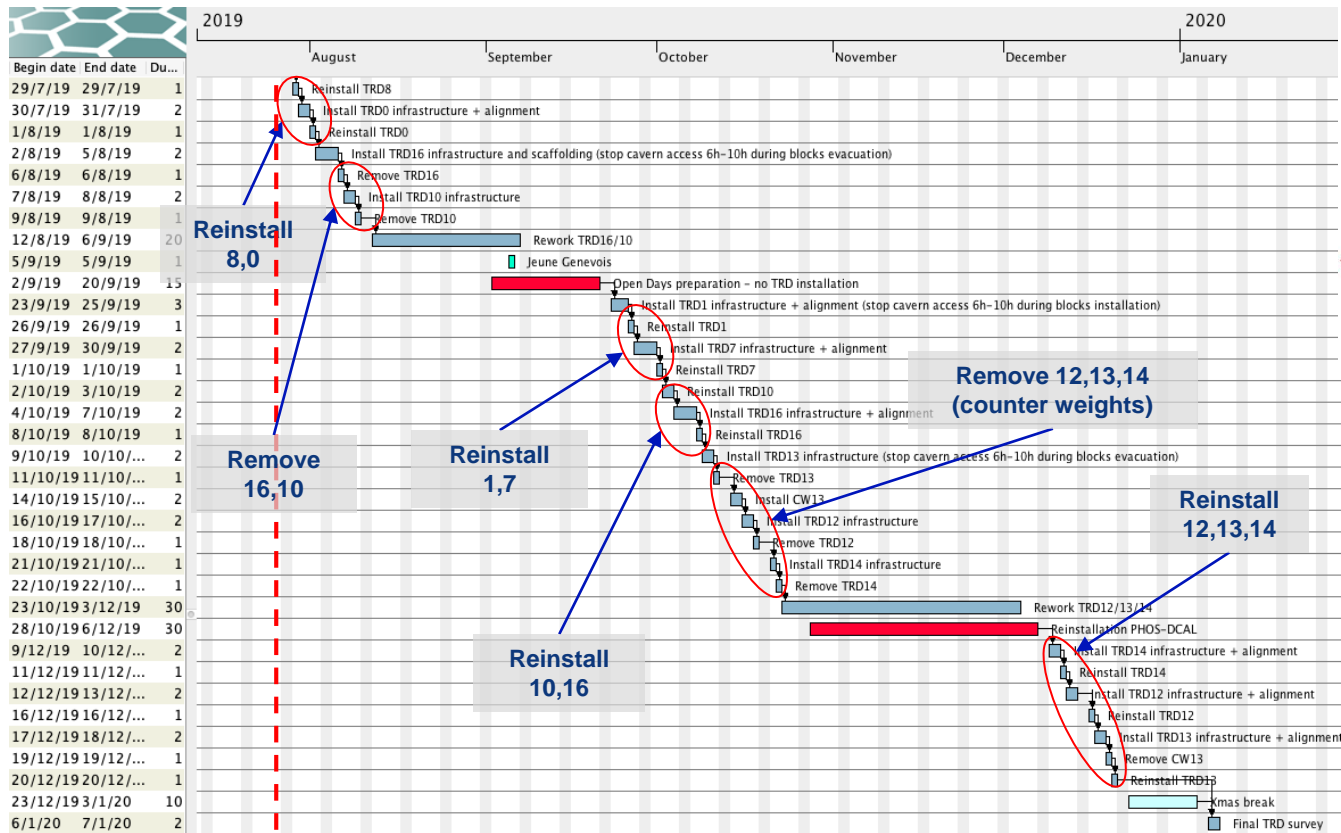

TPC upgrade sequence v34

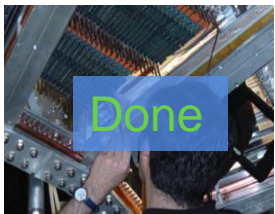

Remove Services and FEE
(outside cleanroom)



Uninstall MWPC ROC



Install GEM ROC



Install new FEC + test



Transportation to SX2



TPC in cleanroom.
Cleaning & irradiation tests

7 Mar

11 Apr



FC HV infrastructure
modification

25 Apr (A)
30 Jul (C)

27 May (A)
13 Aug (C)



Survey, sealing,
overpressure test

17 Jun (A)
21 Aug (C)

2 Jul (A)
4 Sep (C)



Pre-commissioning with
cosmic, Laser, pulser, Xray

2 Oct (A)
23 Oct (C)

31 Oct (A)
4 Dec (C)
21 Jan (Xray)

18 Feb 2020

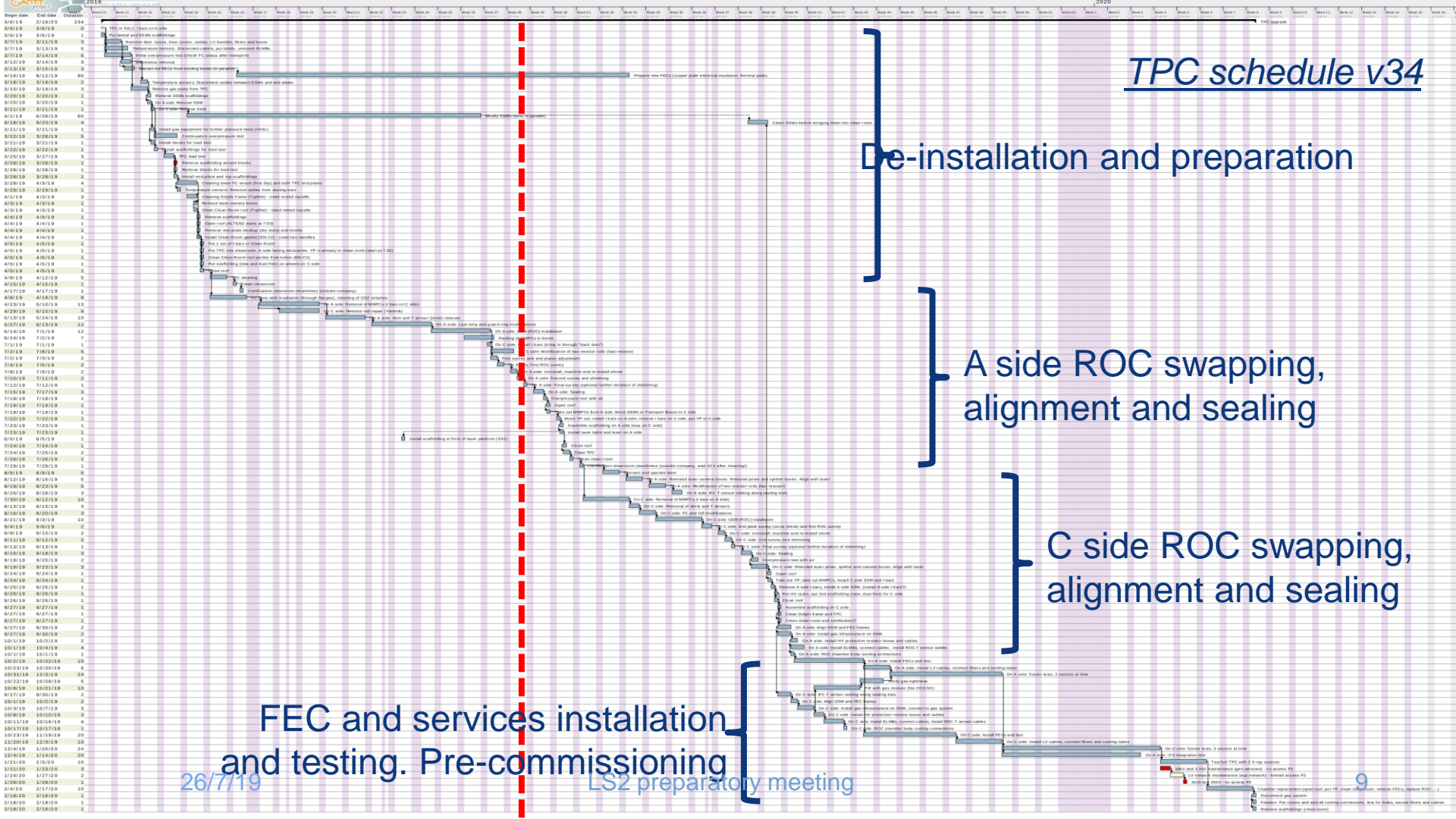

TPC schedule v34

De-installation and preparation

A side ROC swapping, alignment and sealing

C side ROC swapping, alignment and sealing

FEC and services installation and testing. Pre-commissioning

26/7/19

LS2 preparatory meeting

Copper cables (EN-EA)

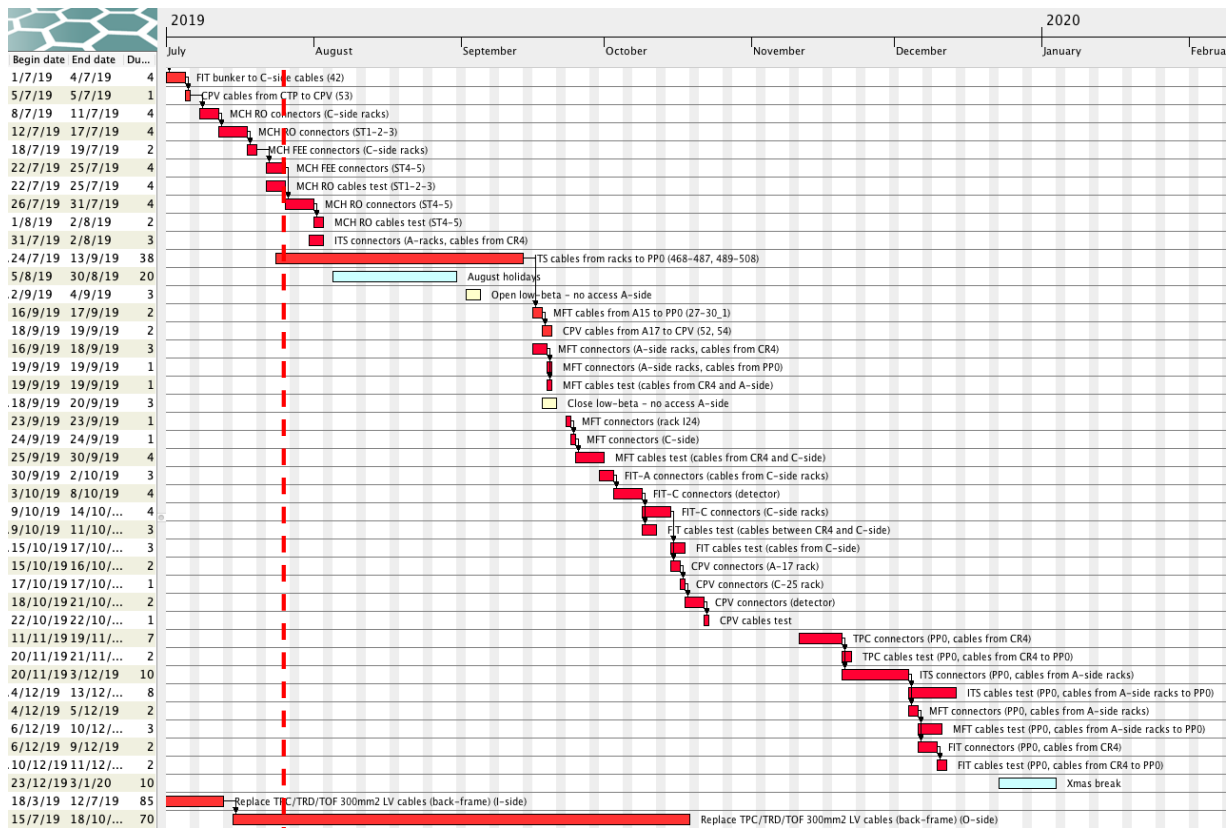

Copper cables (EN-EA) – progress

ALICE LS2 - EN-EA cabling control follow-up 26-07-2019

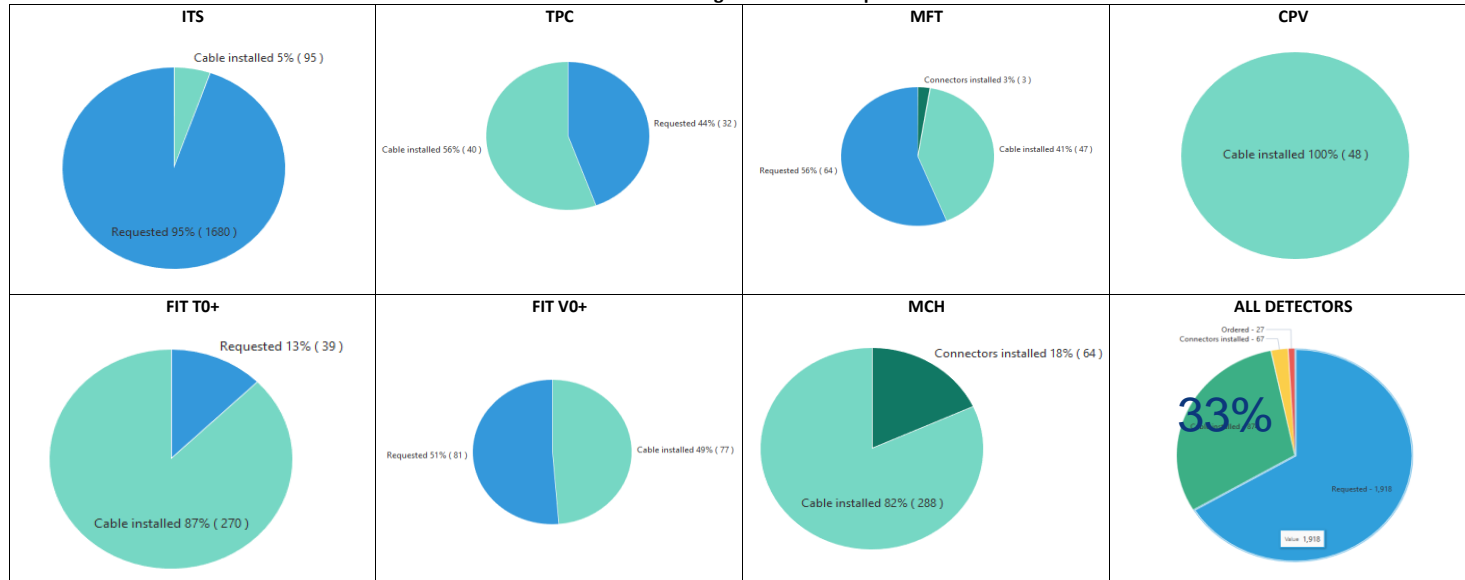

Optical fibers (EN-EL)

Begin date	End date
30/9/19	2/10/19
3/10/19	16/10/19
23/12/19	3/1/20
28/1/20	27/3/20
8/4/20	8/4/20
24/4/20	24/4/20
4/5/20	15/5/20
18/5/20	20/5/20

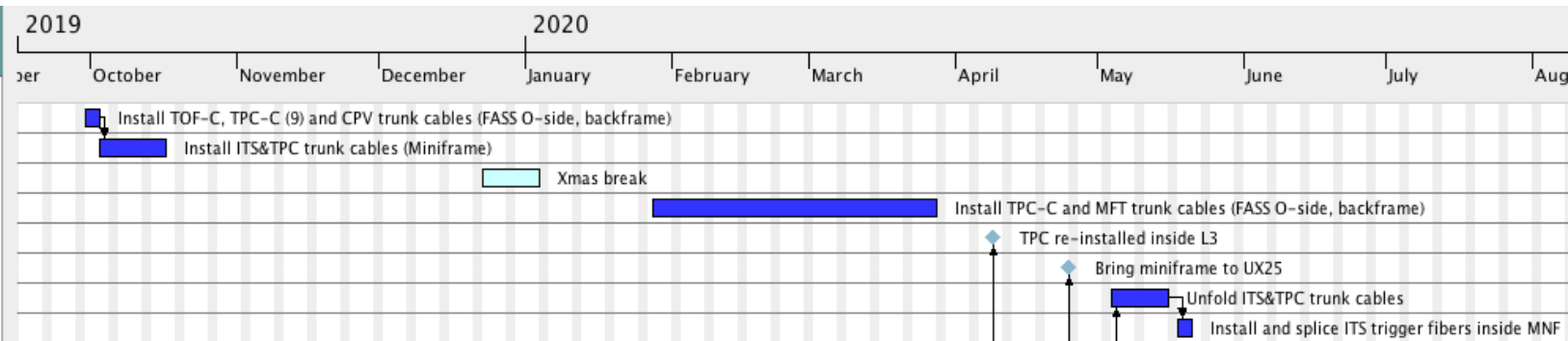

Miniframe planning

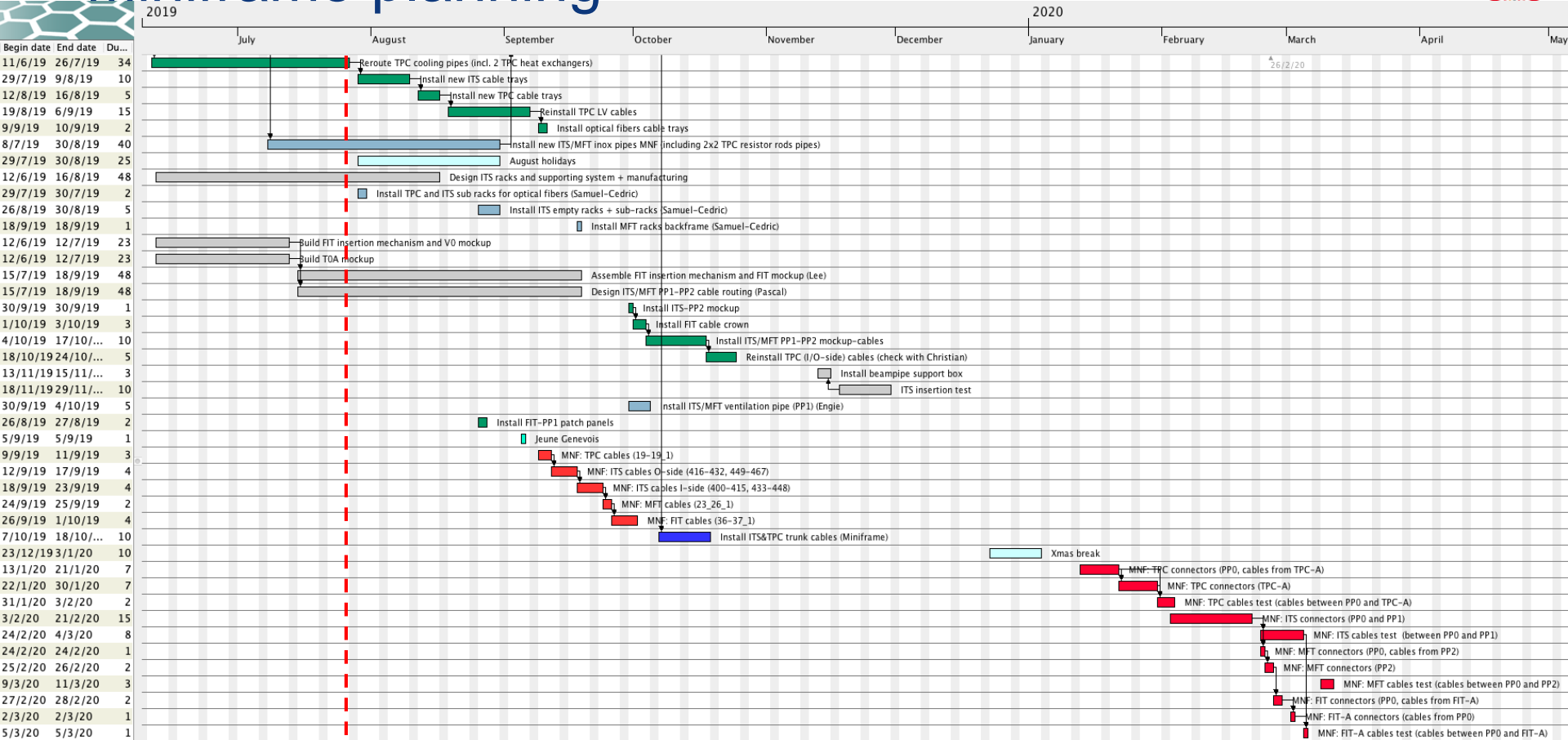

CR0 planning

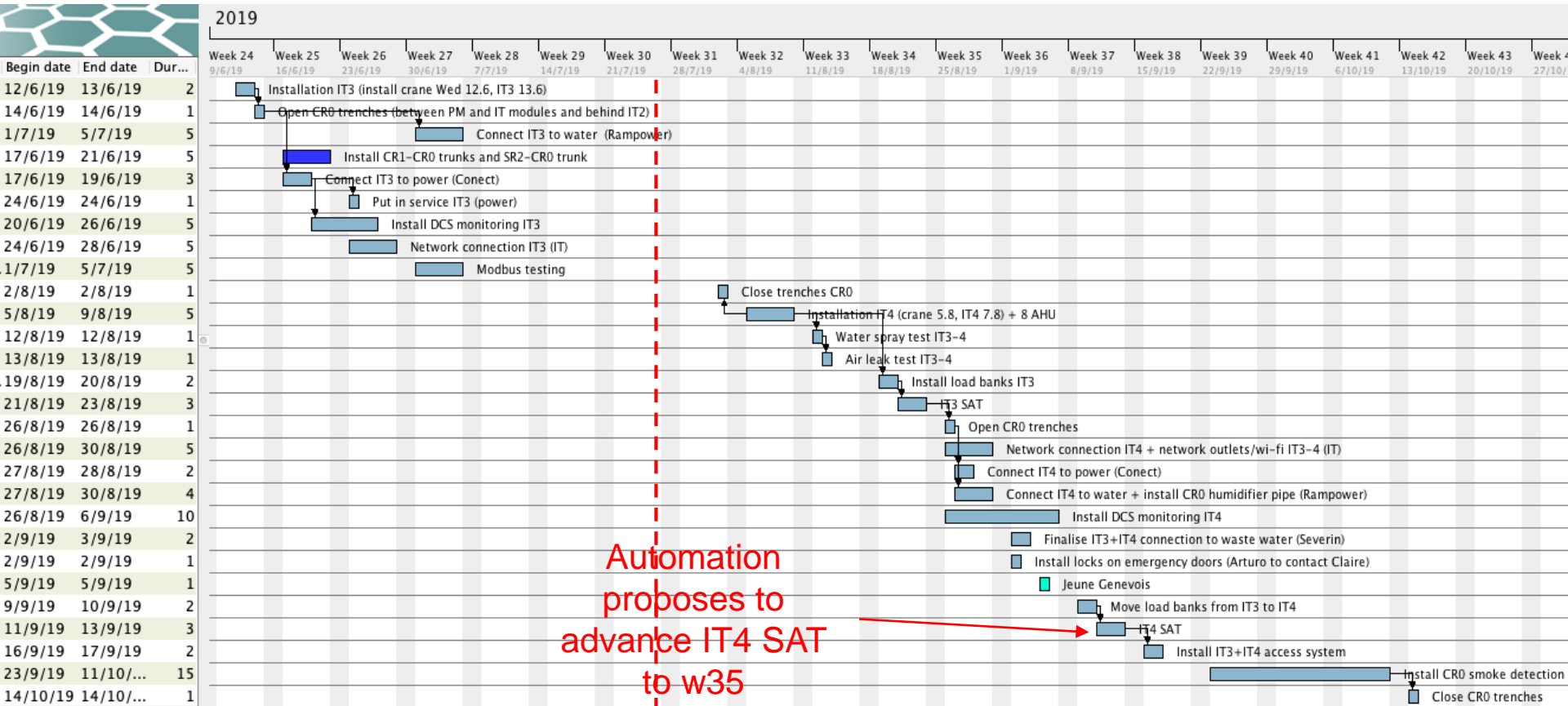

Automation
proposes to
advance IT4 SAT
to w35

LS2 preparatory meeting

26/7/19

Day-by-day sequence w30

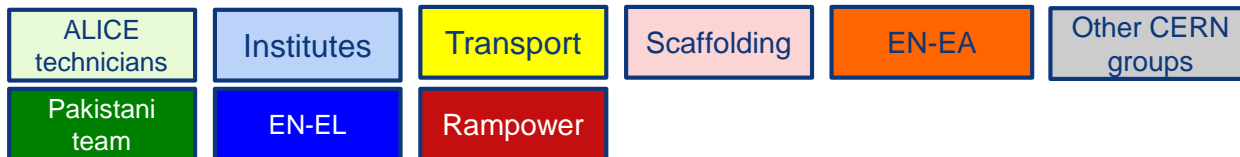

UX25 activities w30 – Mon 22 Jul 2019

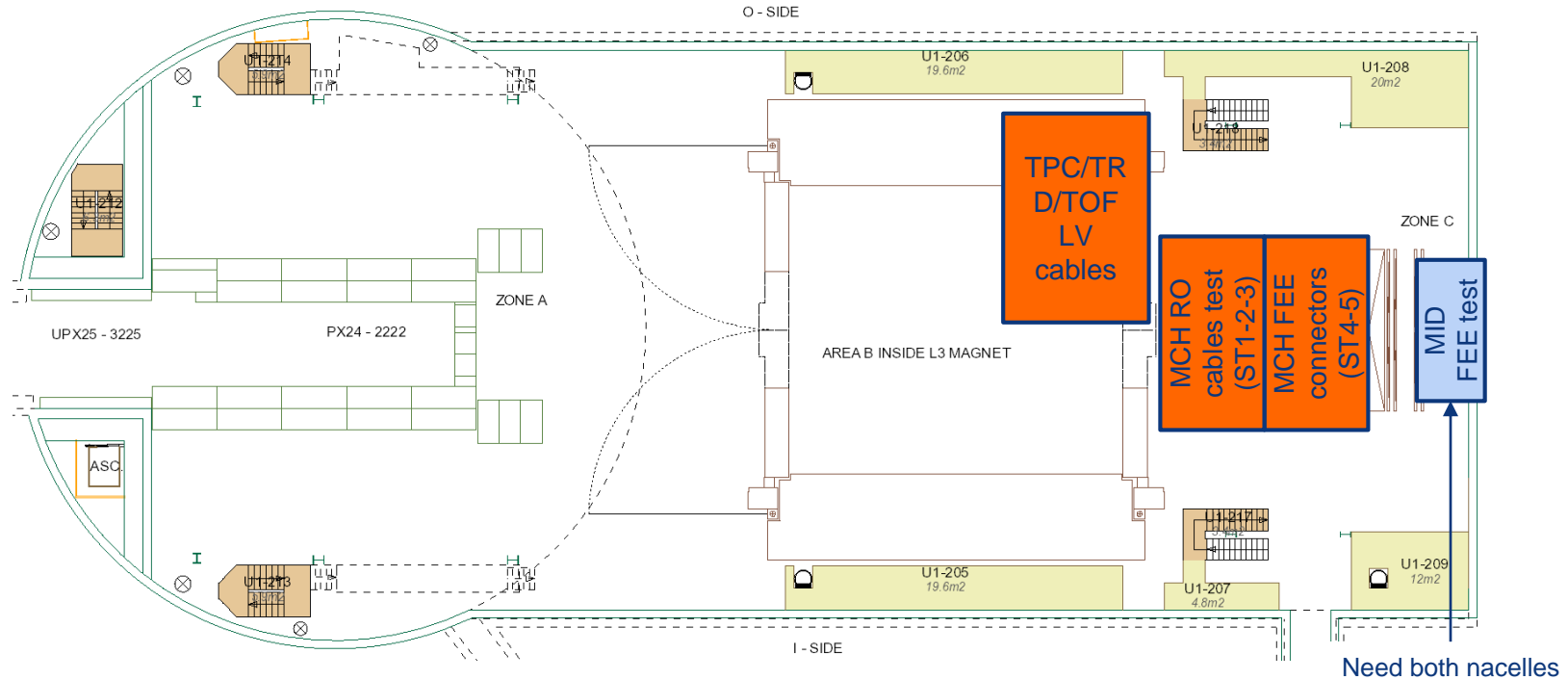

UX25 activities w30 – Tue 23 Jul 2019

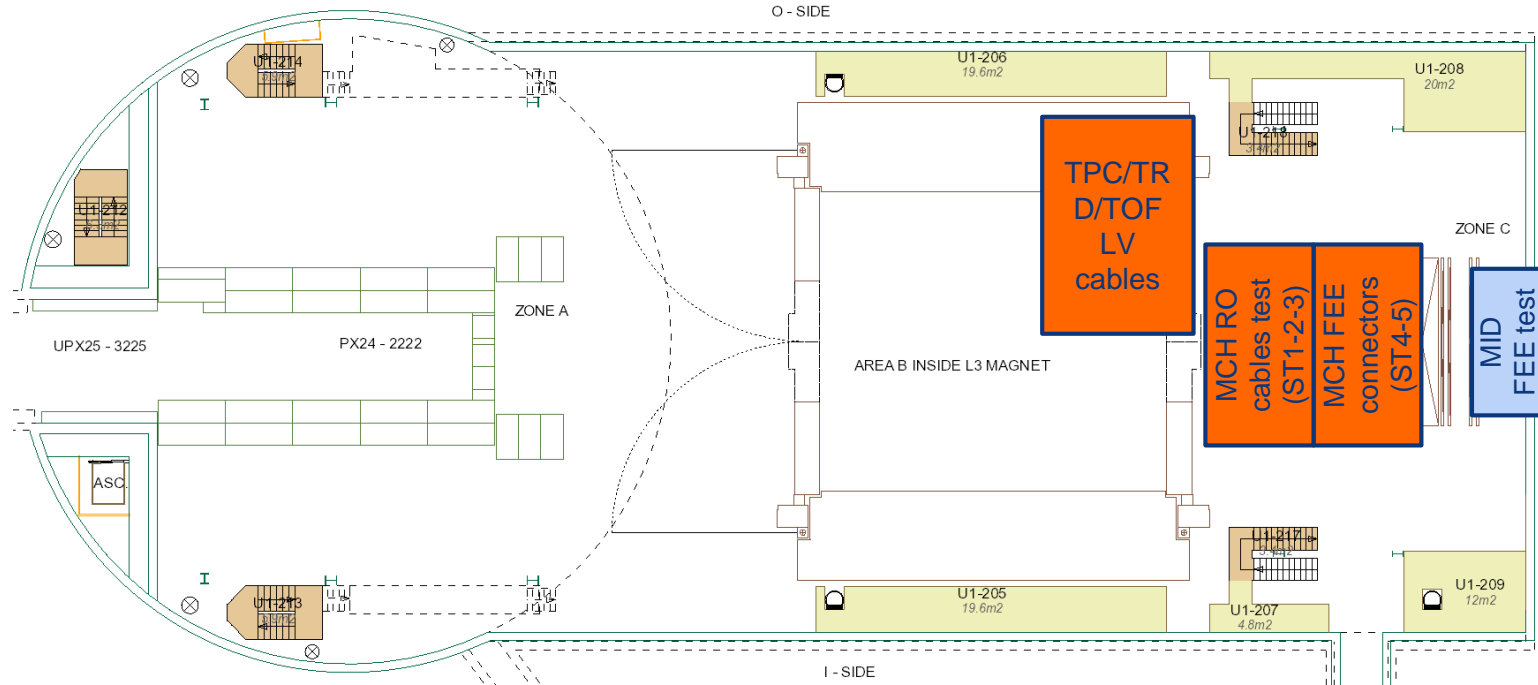

UX25 activities w30 – Wed 24 Jul 2019

Restart flammable gas for MTR

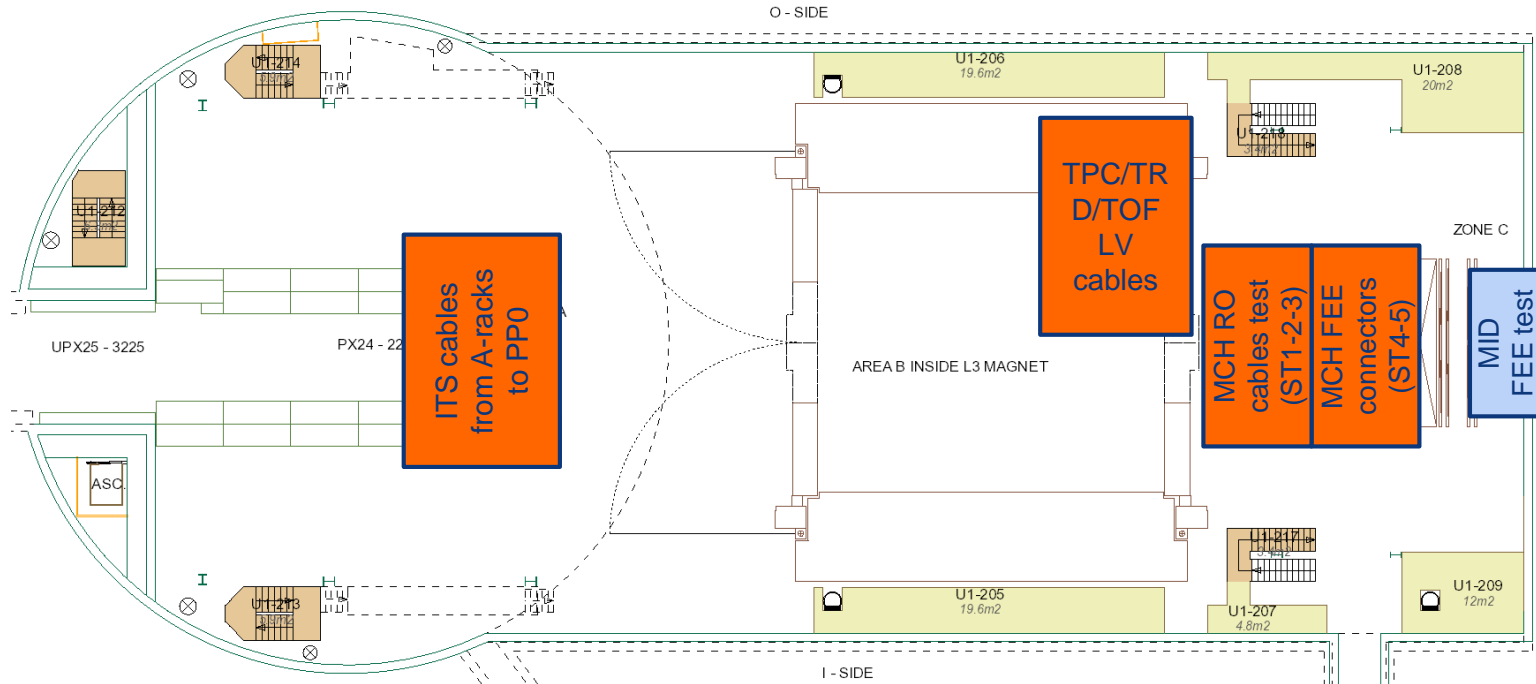

UX25 activities w30 – Thu 25 Jul 2019

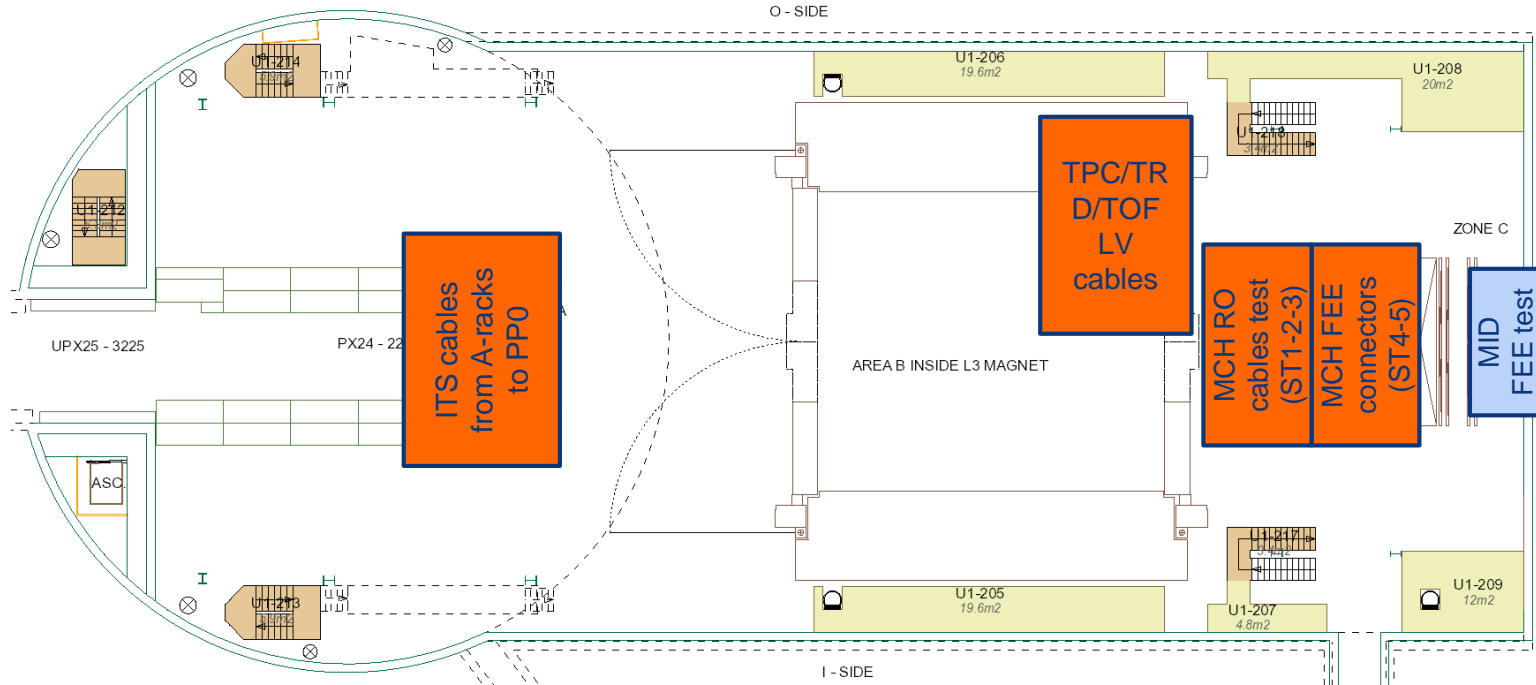

UX25 activities w30 – Fri 26 Jul 2019

Lift maintenance (AS-724): no access to UX25 from Friday 26.7 12:00 to Saturday 27.7 18:00

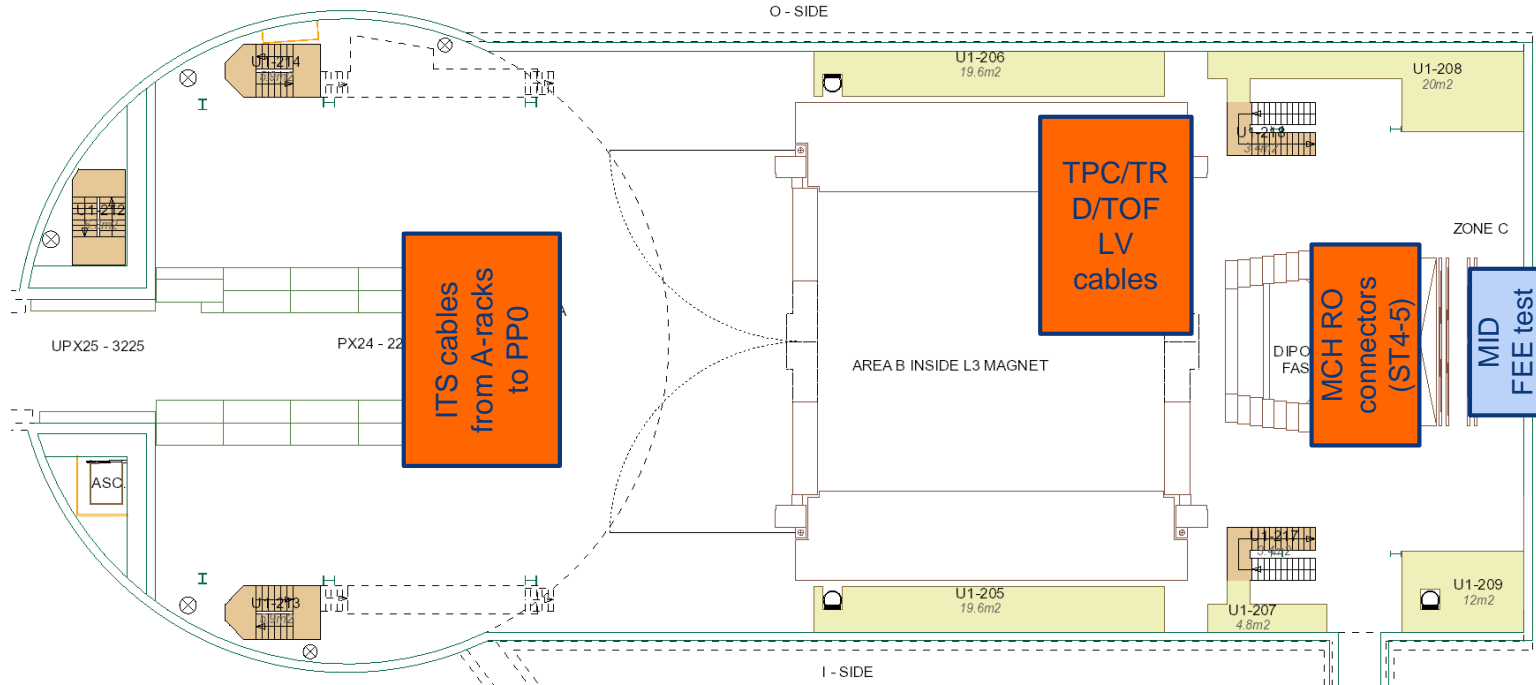

SXL2 activities w30 – Mon 22 Jul 2019

Inside the cleanroom: coats + charlottes + overshoes obligatory

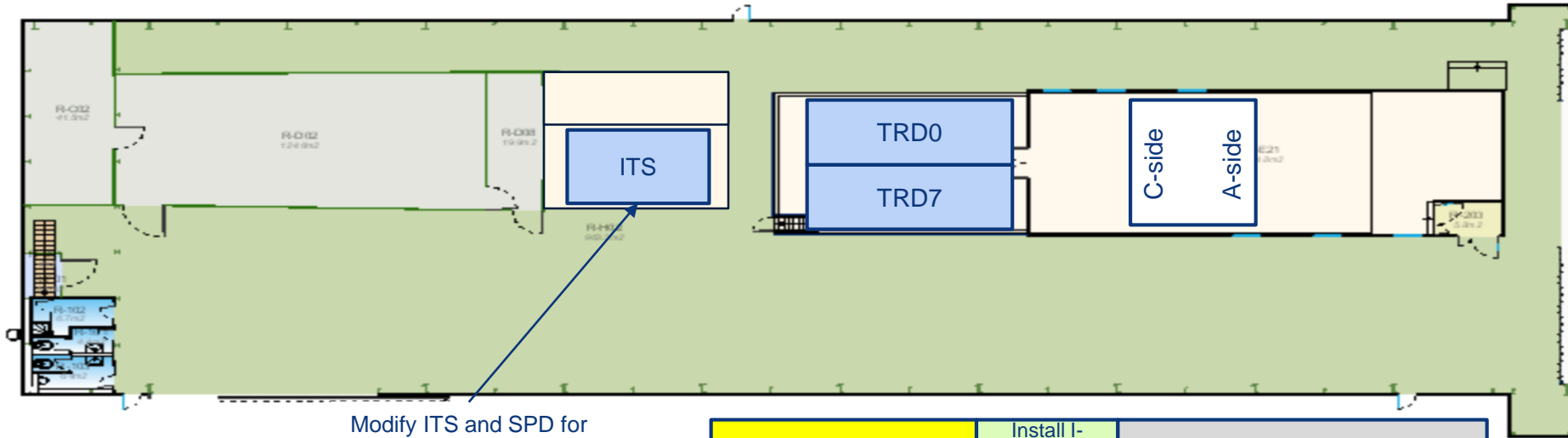

Modify ITS and SPD for expo. (need crane at some point)

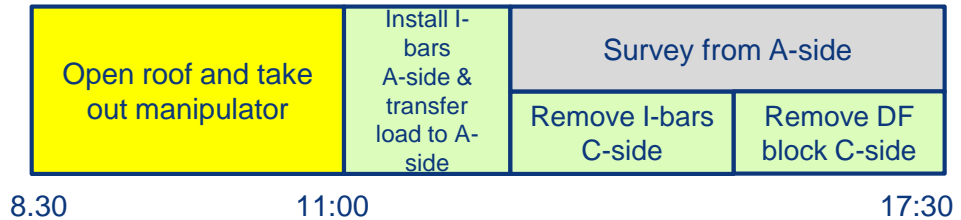

SXL2 activities w30 – Tue 23 Jul 2019

Inside the cleanroom: coats + charlottes + overshoes obligatory

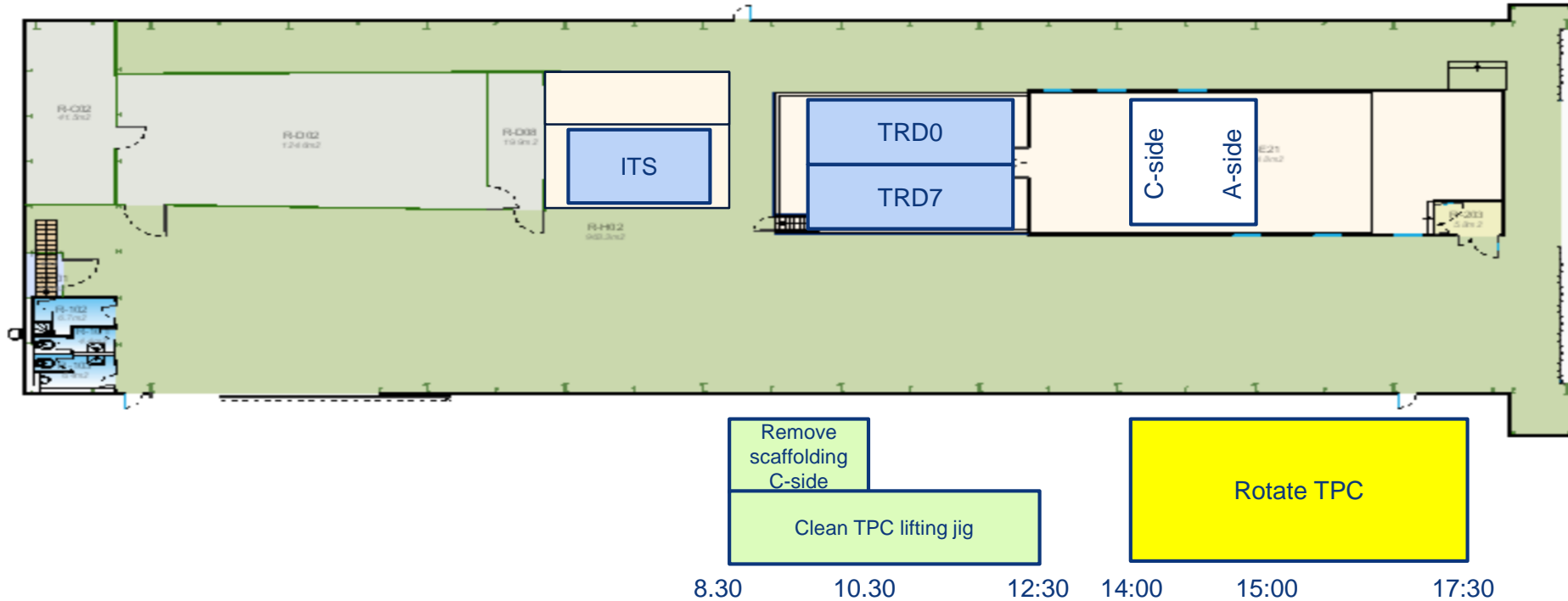

SXL2 activities w30 – Wed 24 Jul 2019

Inside the cleanroom: coats + charlottes + overshoes obligatory

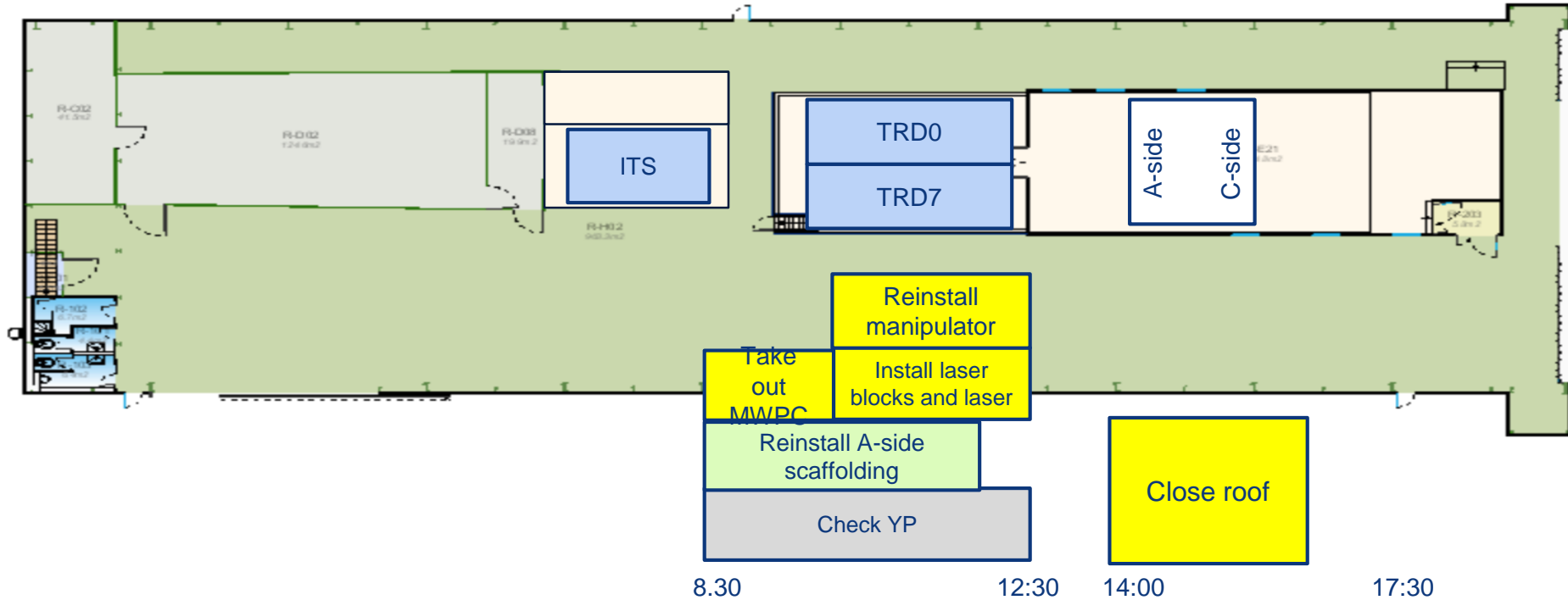

SXL2 activities w30 – Thu 25 Jul 2019

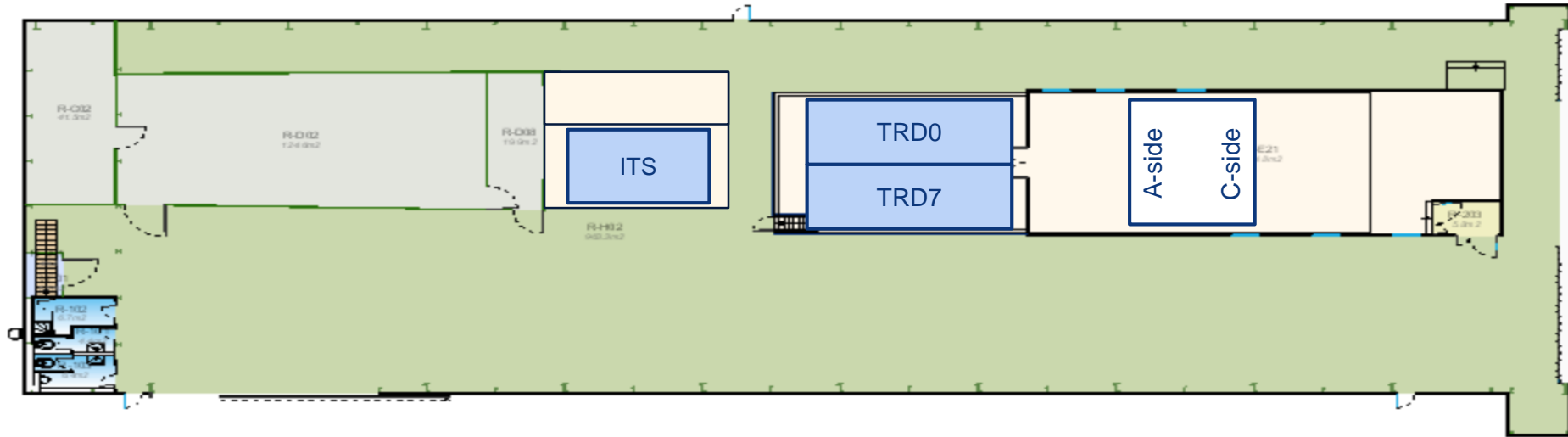

SXL2 activities w30 – Fri 26 Jul 2019

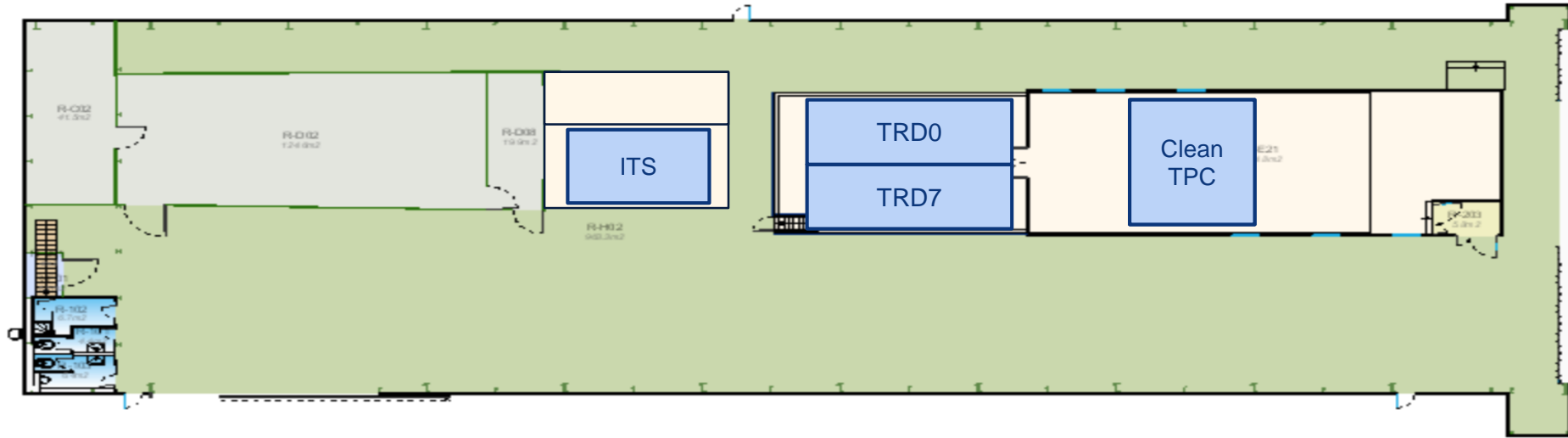

Miniframe activities w30 – Mon 22 Jul 2019

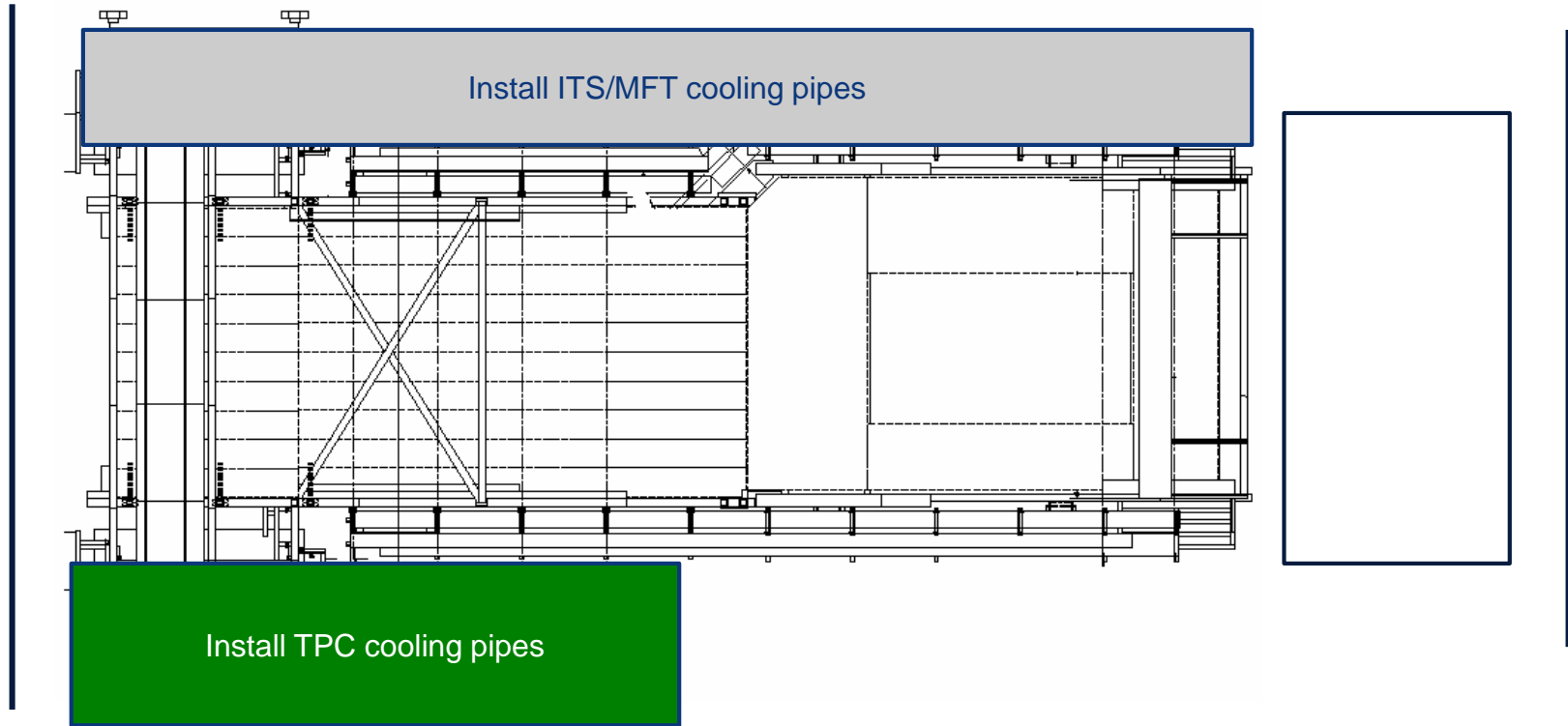

Miniframe activities w30 – Tue 23 Jul 2019

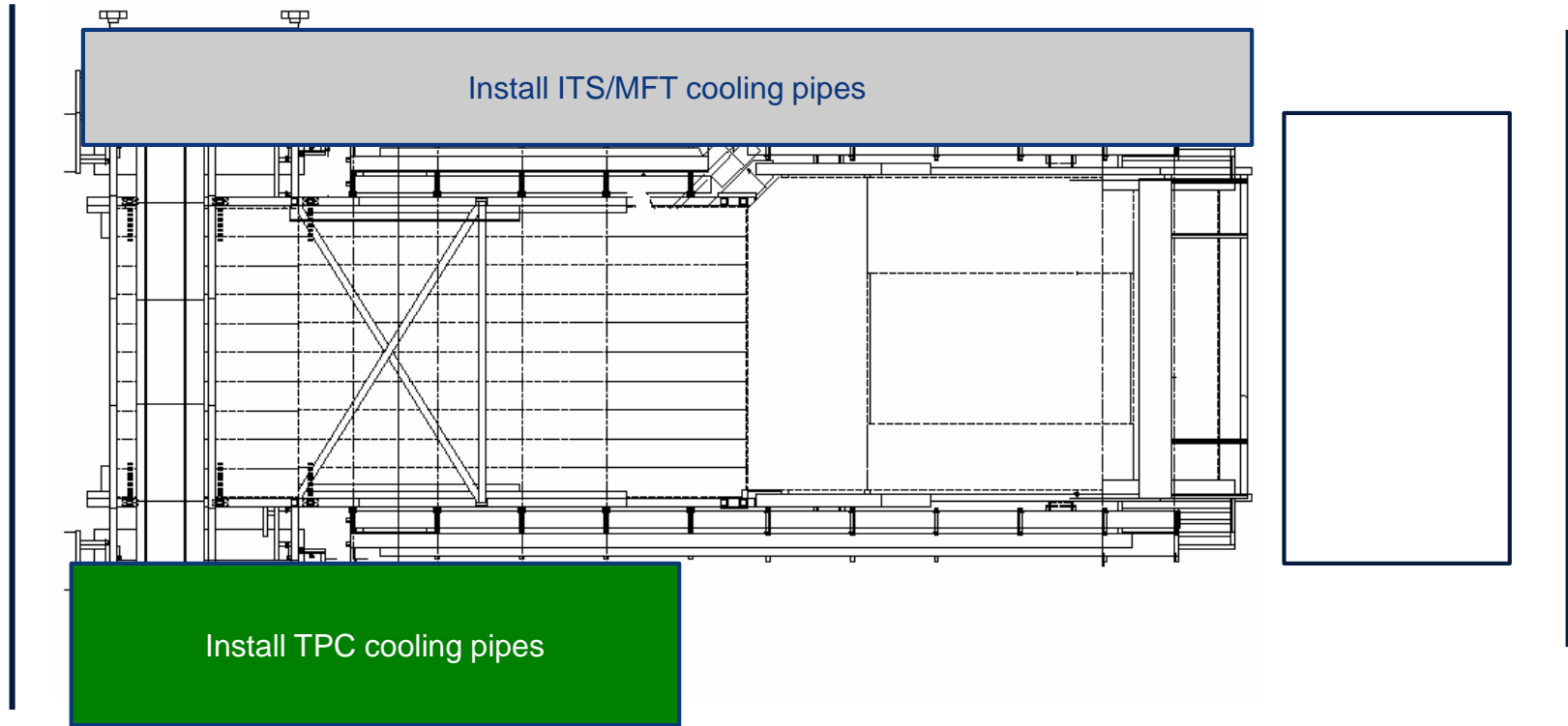

Miniframe activities w30 – Wed 24 Jul 2019

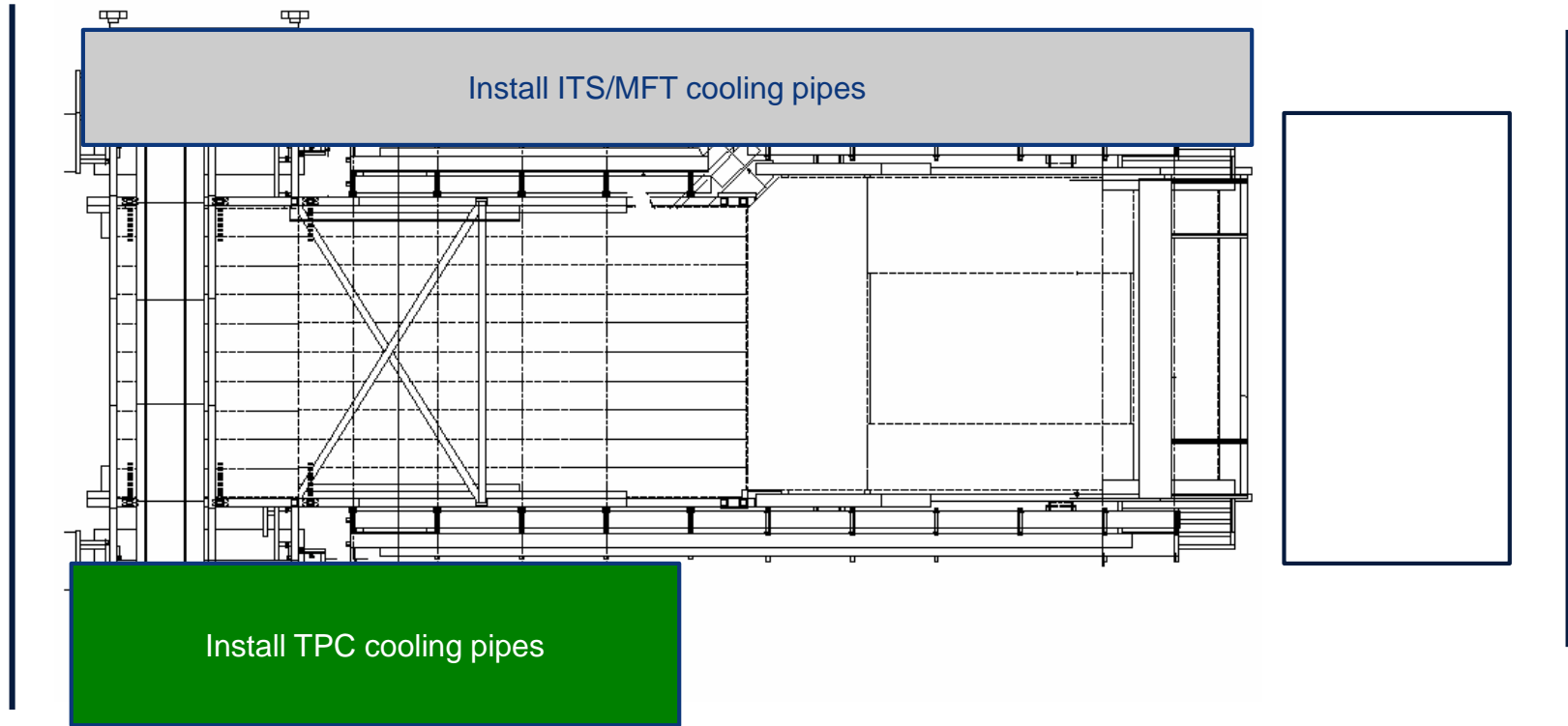

Miniframe activities w30 – Thu 25 Jul 2019

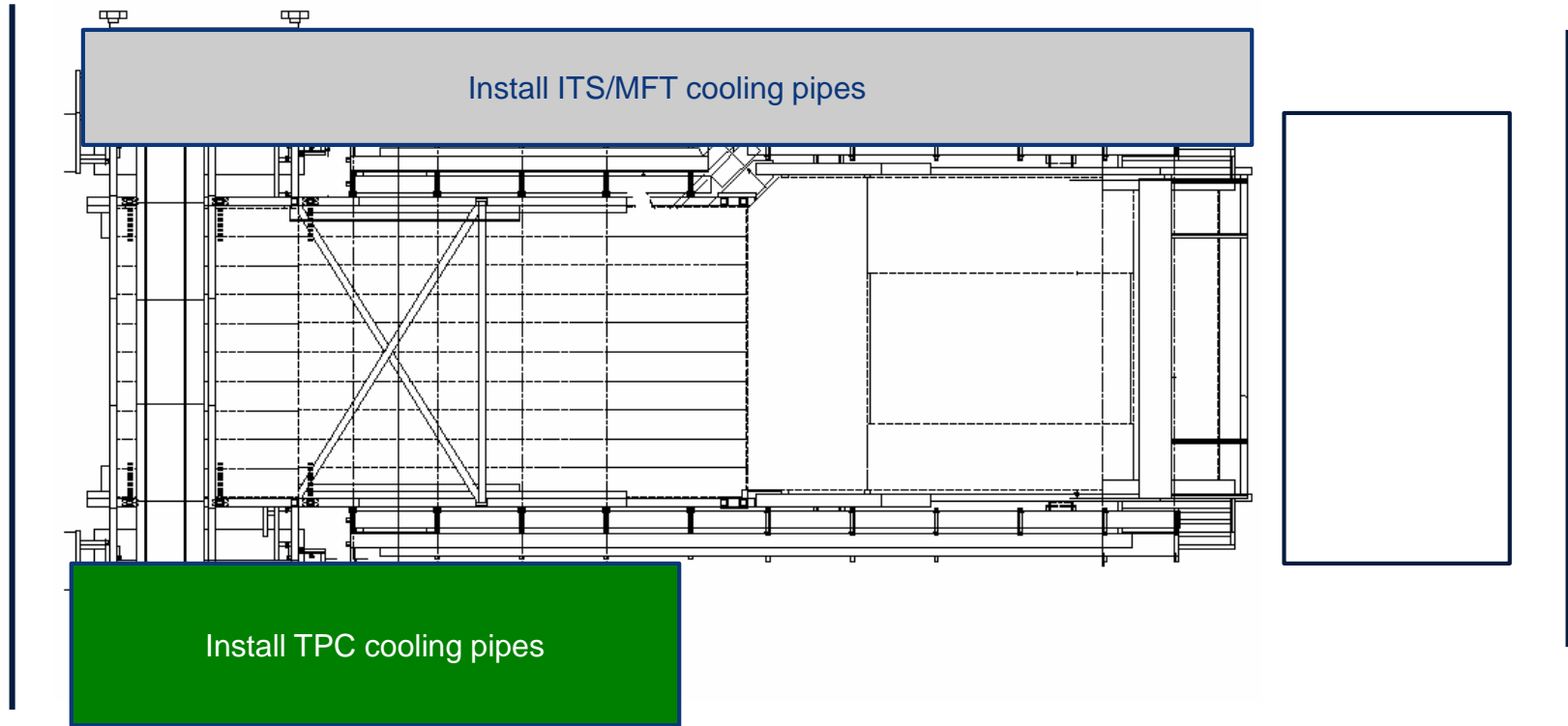

Miniframe activities w30 – Fri 26 Jul 2019

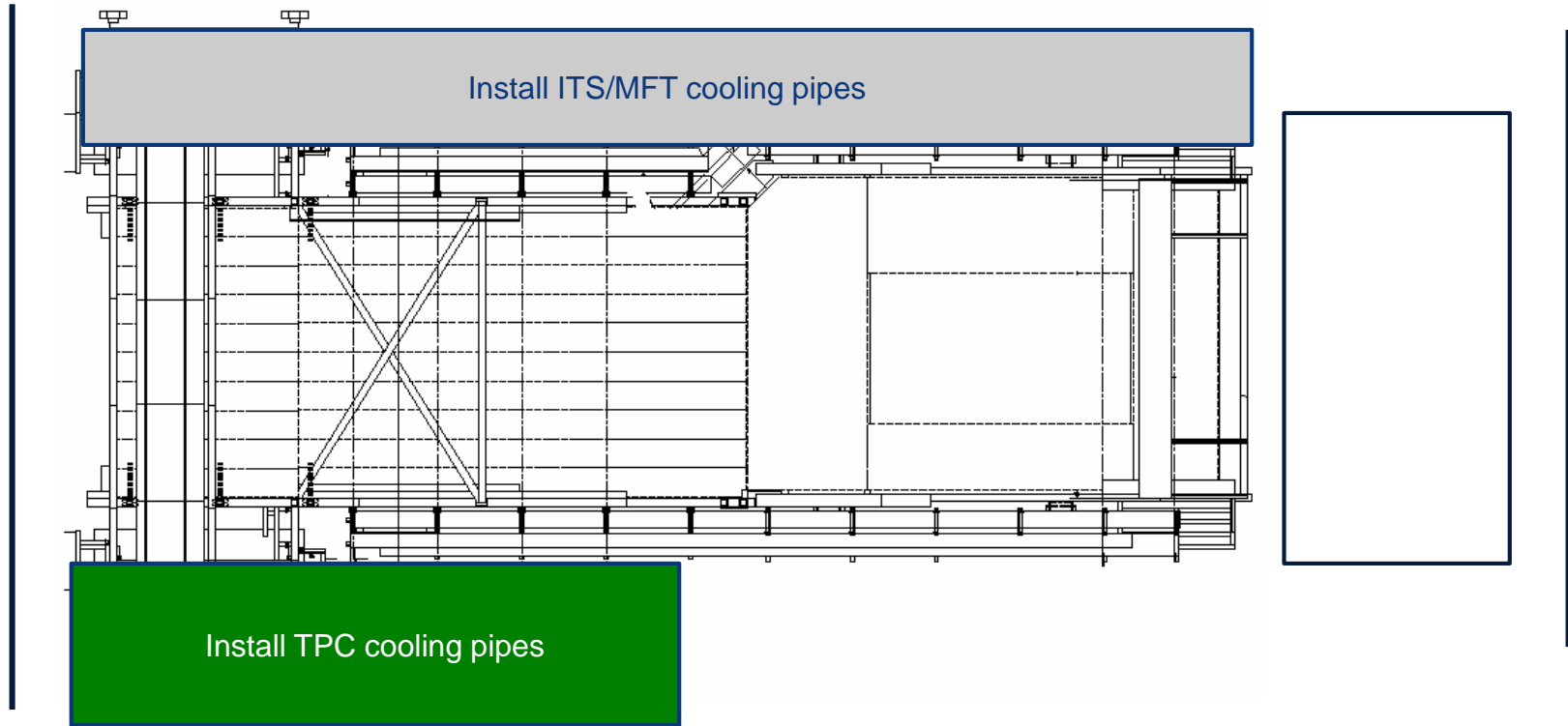

Day-by-day sequence w31



UX25 activities w31 – Mon 29 Jul 2019

ALTEAD: close CR0 trenches

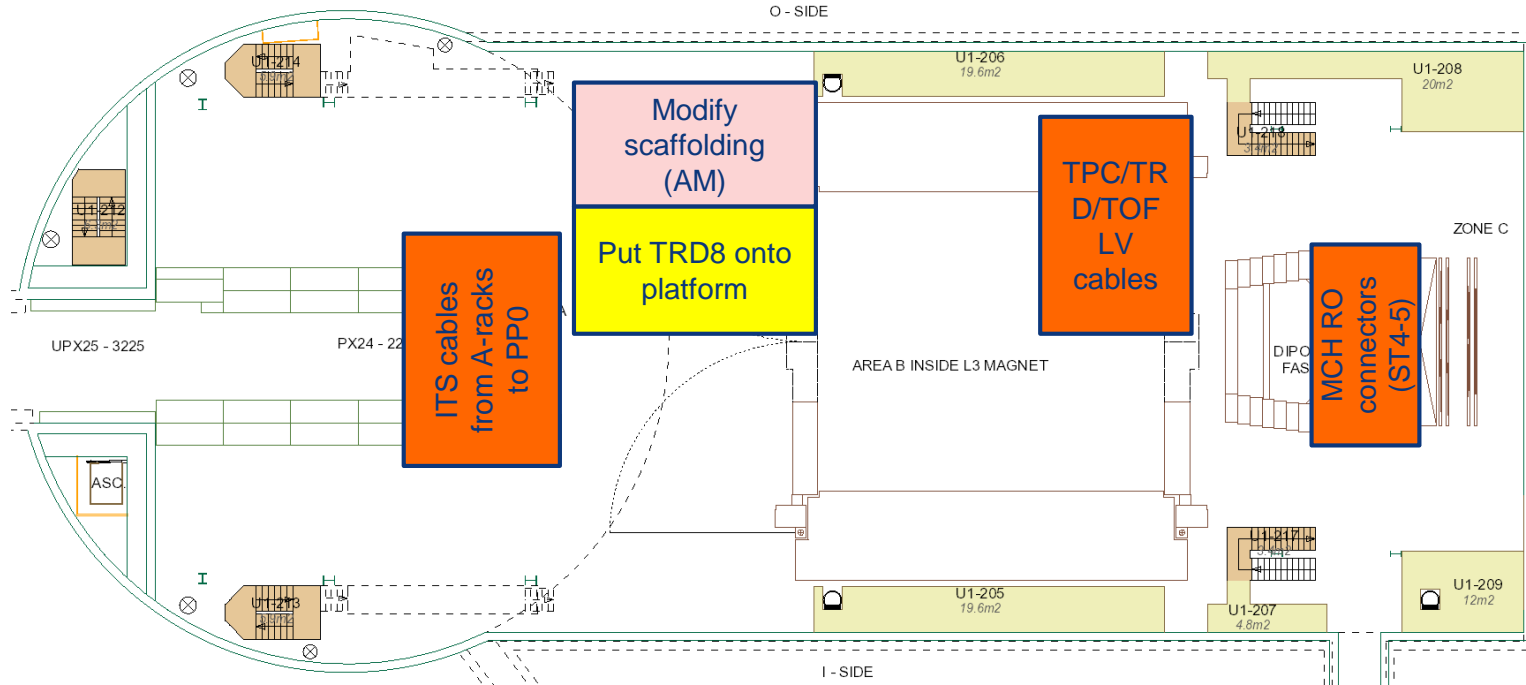

UX25 activities w31 – Tue 30 Jul 2019

ALTEAD: remove CV equipment (part 1)

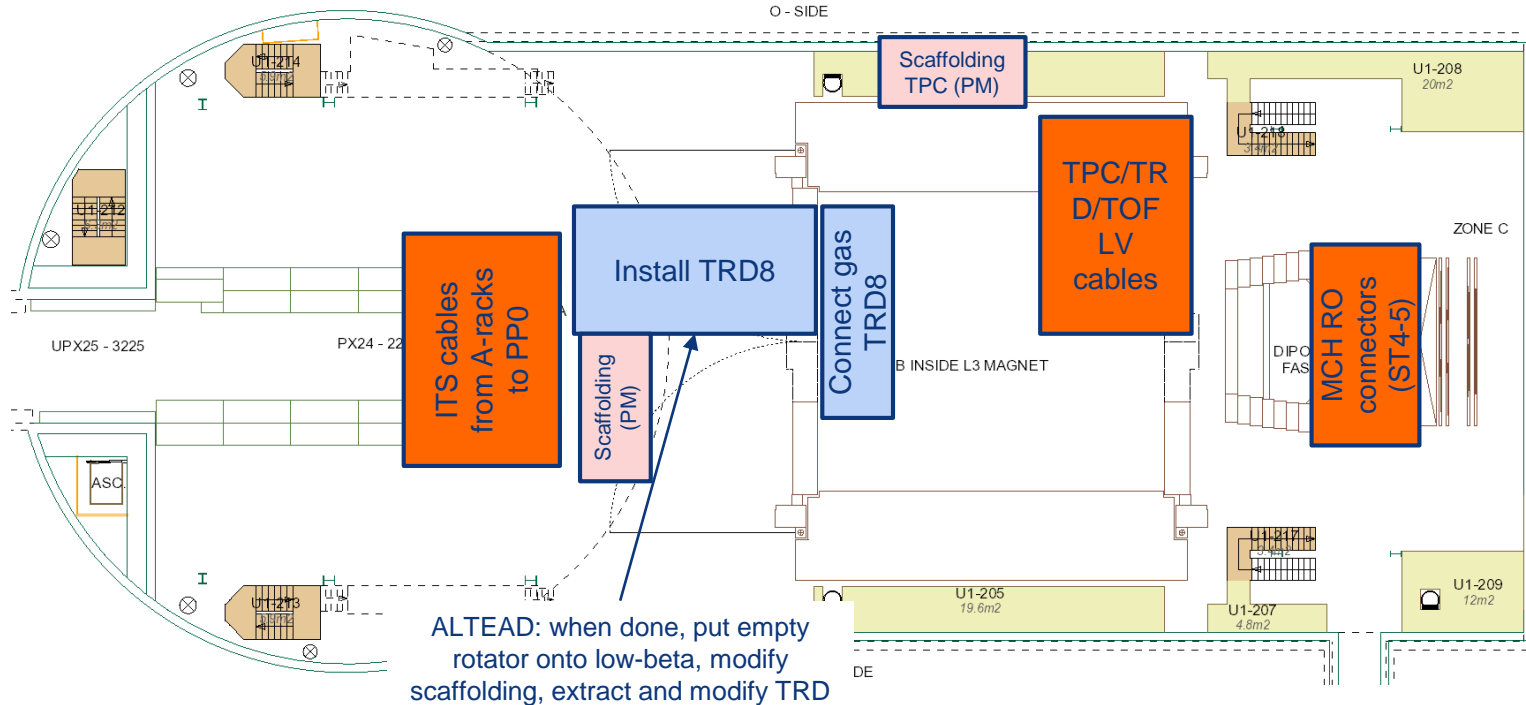

UX25 activities w31 – Wed 31 Jul 2019

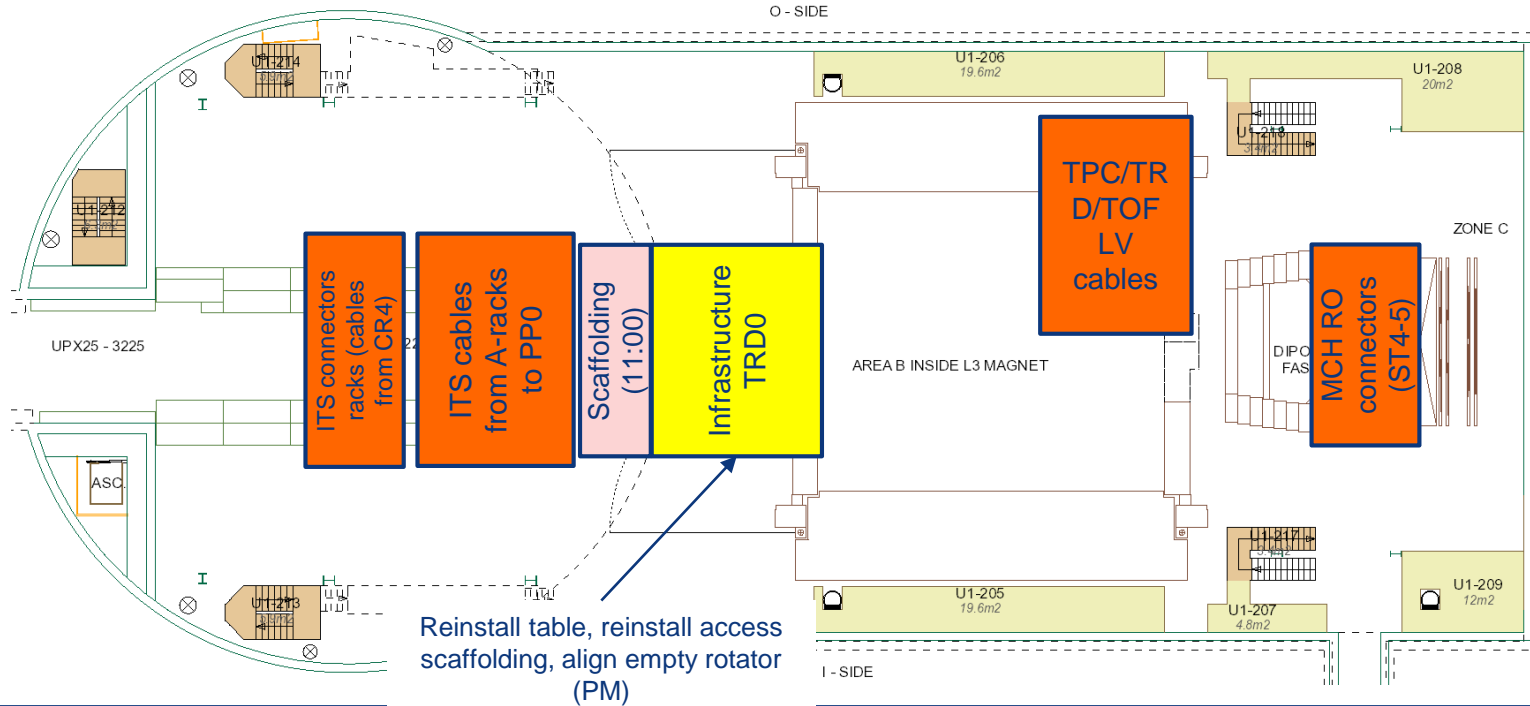

UX25 activities w31 – Thu 1 Aug 2019

ALTEAD: overtime hours

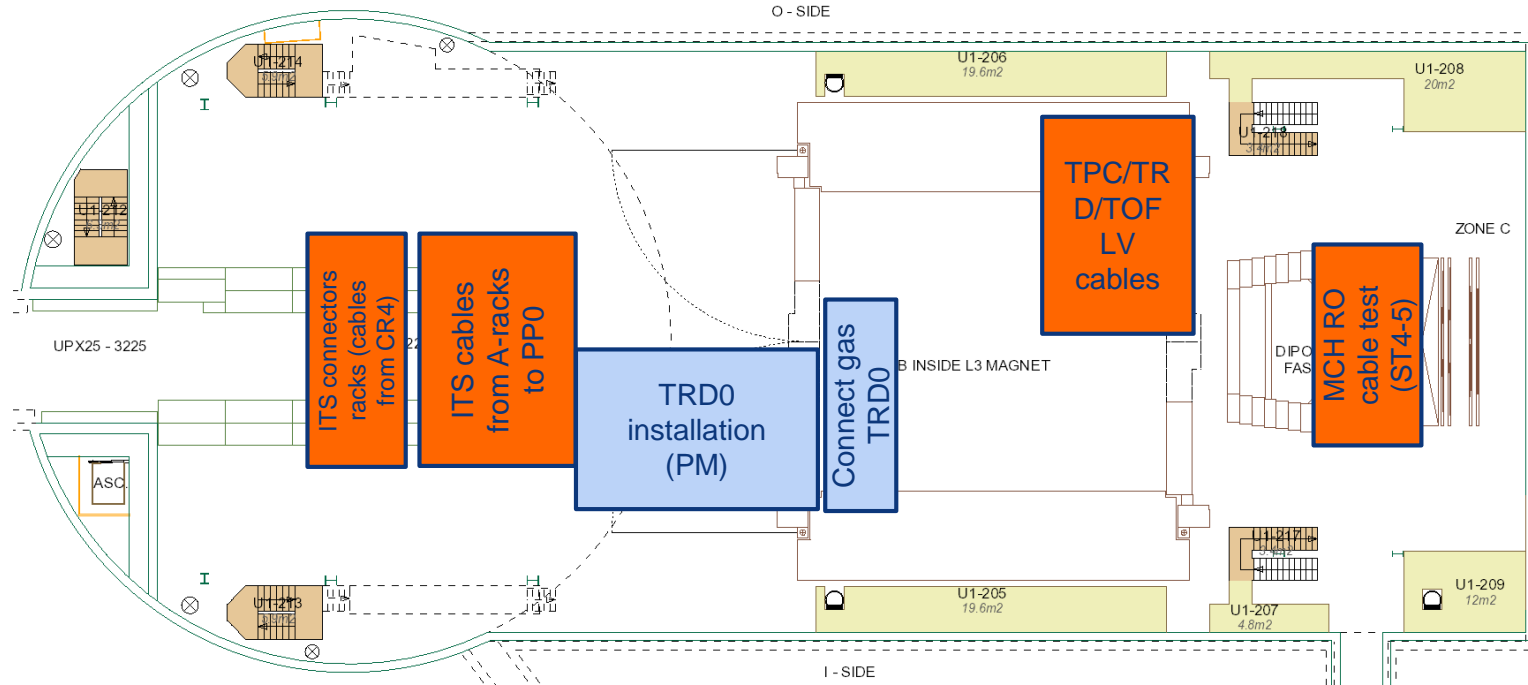

UX25 activities w31 – Fri 2 Aug 2019

STOP flammable gas for MTR

ALTEAD: removal TRD blocks → no access UX24 A-side (PM)

ALTEAD: evacuate blocks from SX2 (Merlot)

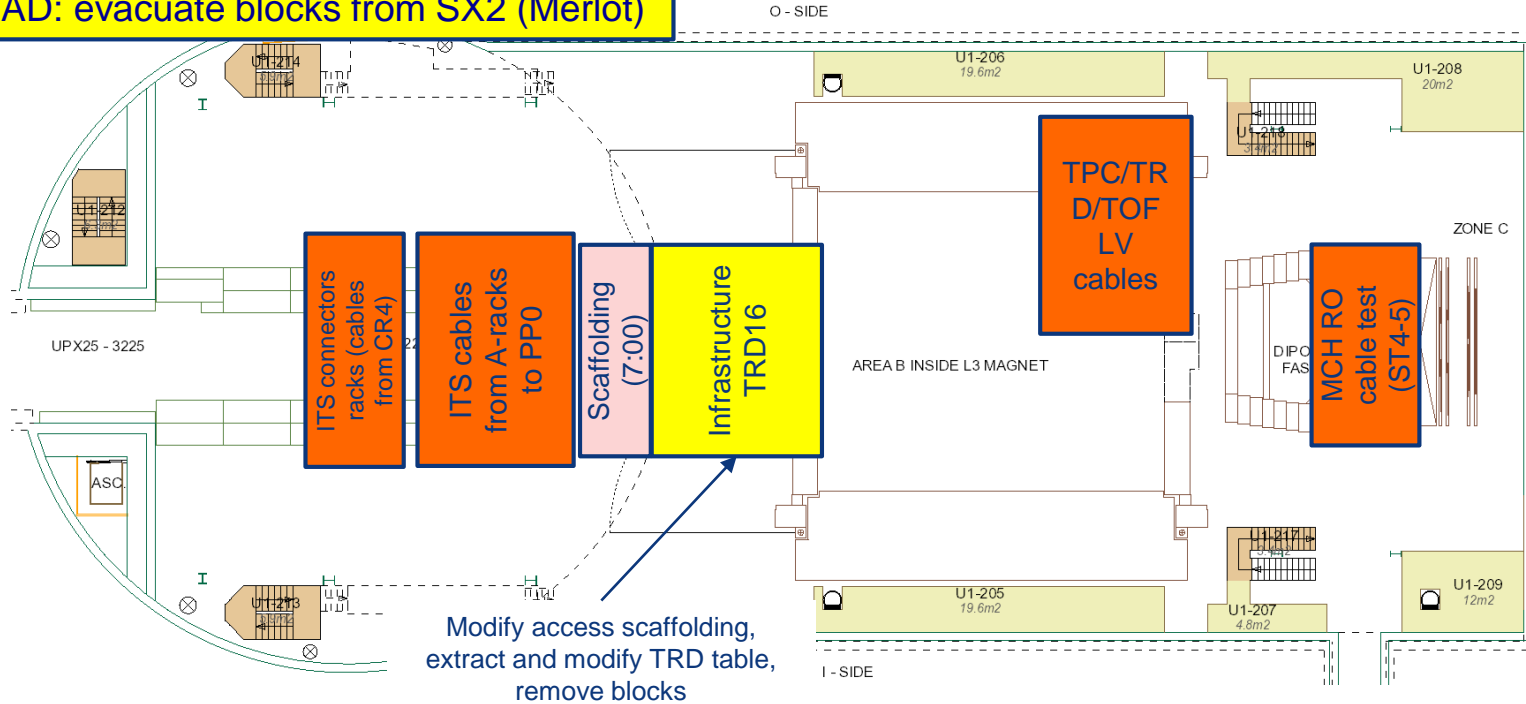

SXL2 activities w31 – Mon 29 Jul 2019

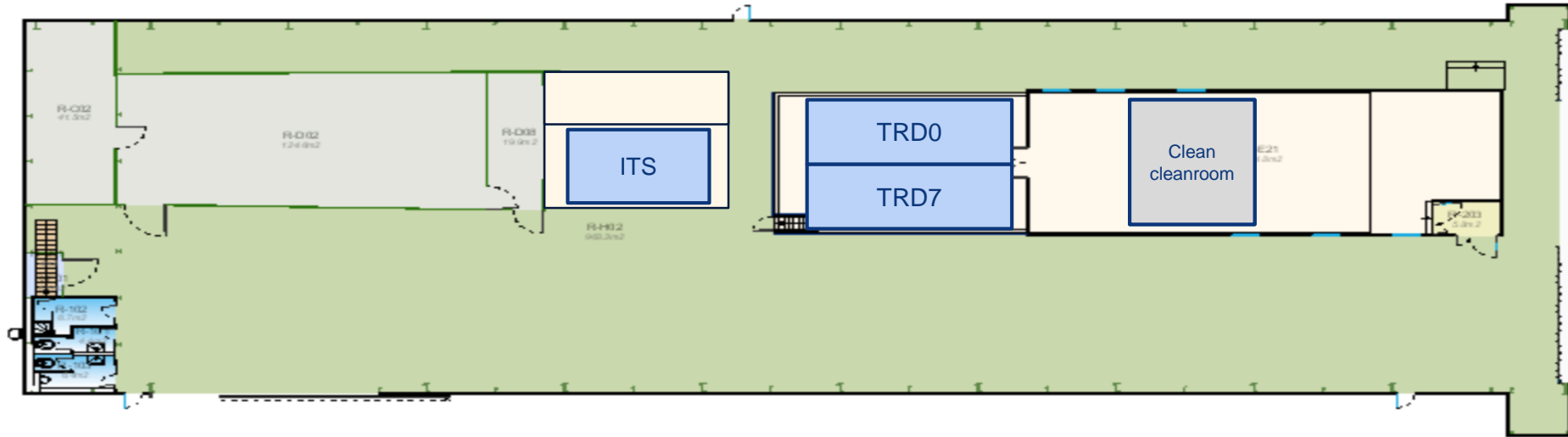

SXL2 activities w31 – Tue 30 Jul 2019

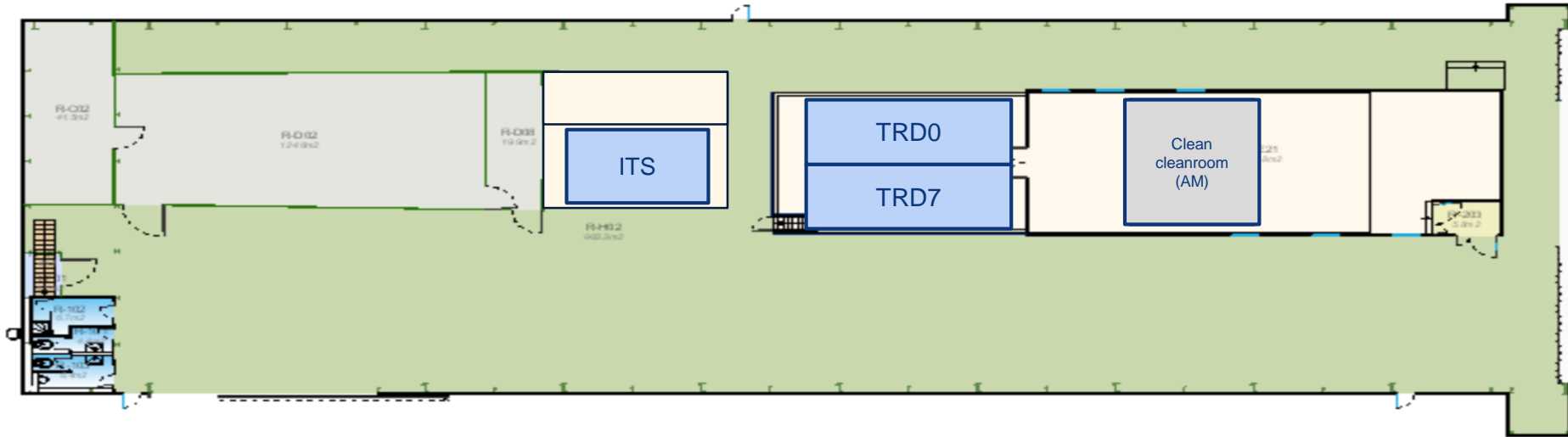

SXL2 activities w31 – Wed 31 Jul 2019

ALTEAD: transportation ITS to SX2 (PM)

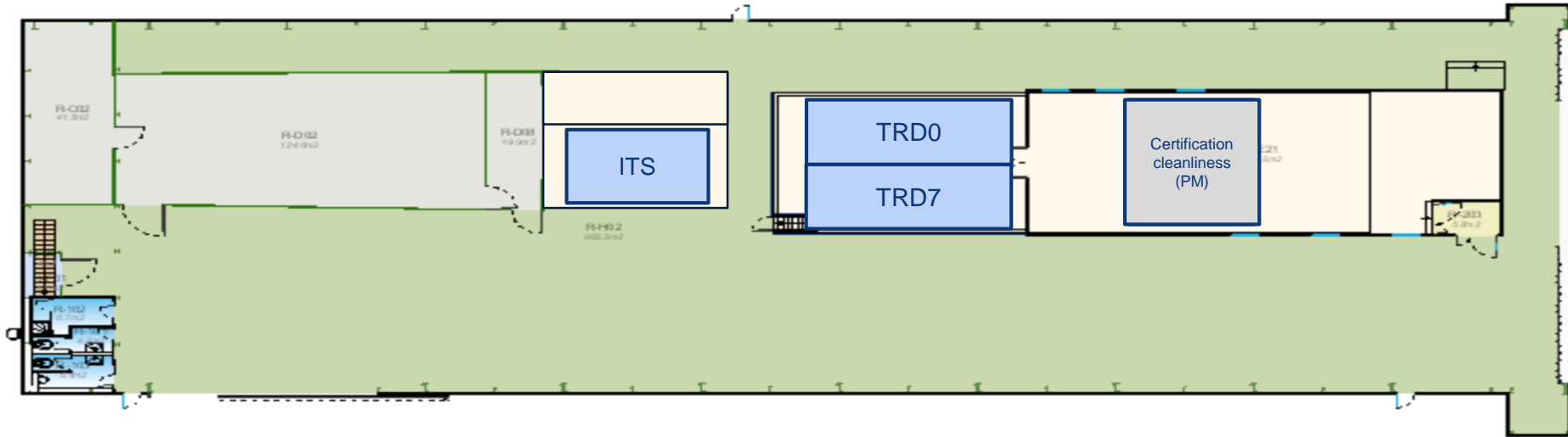

SXL2 activities w31 – Thu 1 Aug 2019

ALTEAD + TRD: insert TRD0 into rotator (AM)

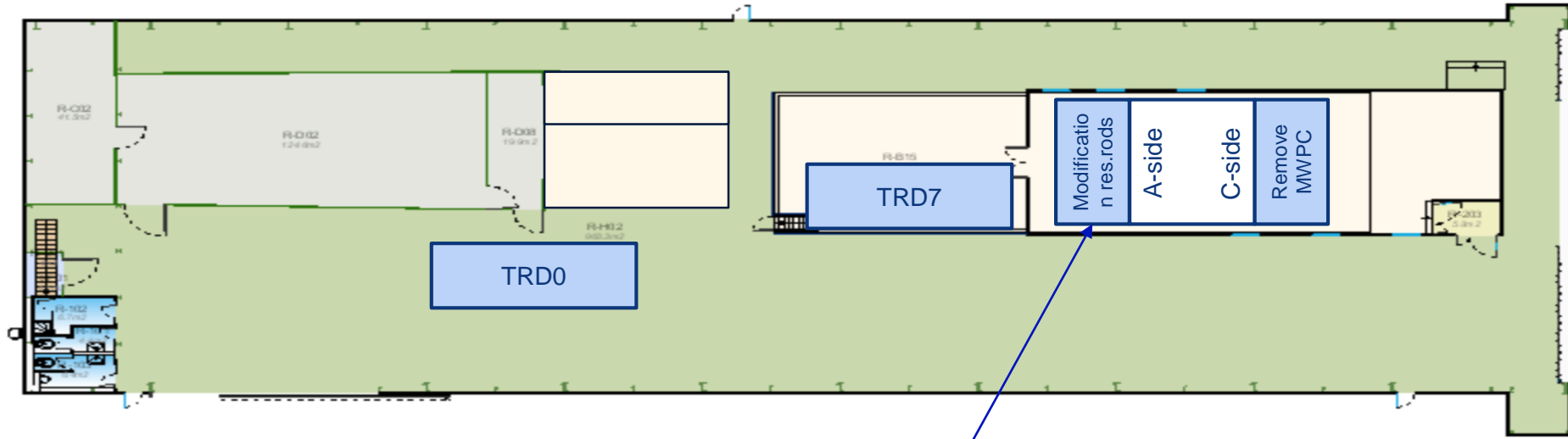

And in parallel: connect and operate laser. On A side:
Reinstall laser camera boxes. Reinstall prism and splitter
boxes. Align with laser

SXL2 activities w31 – Fri 2 Aug 2019

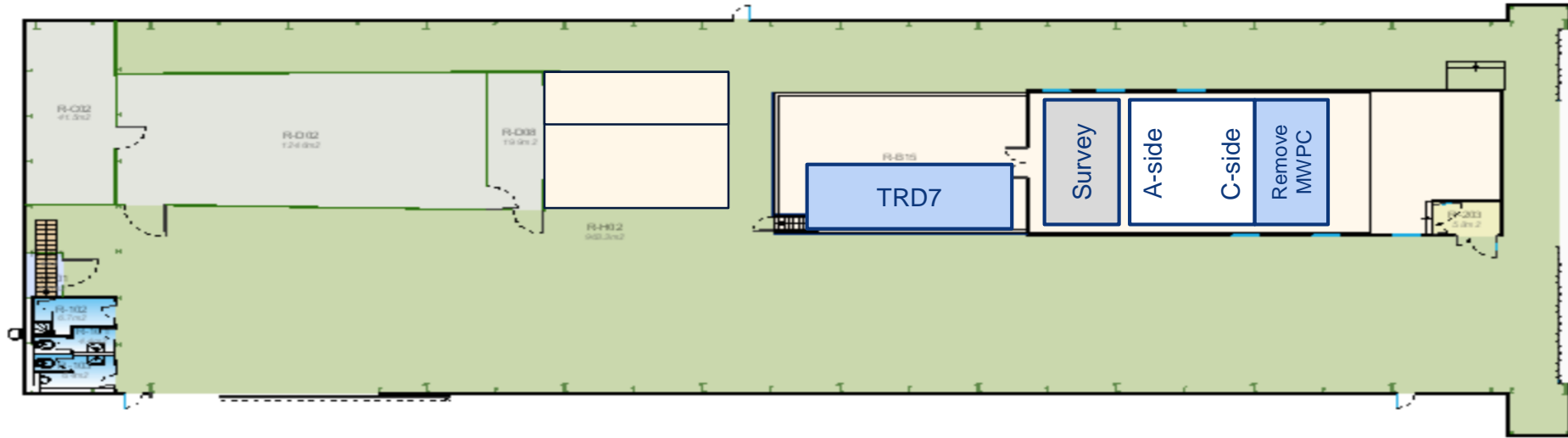

Miniframe activities w31 – Mon 29 Jul 2019

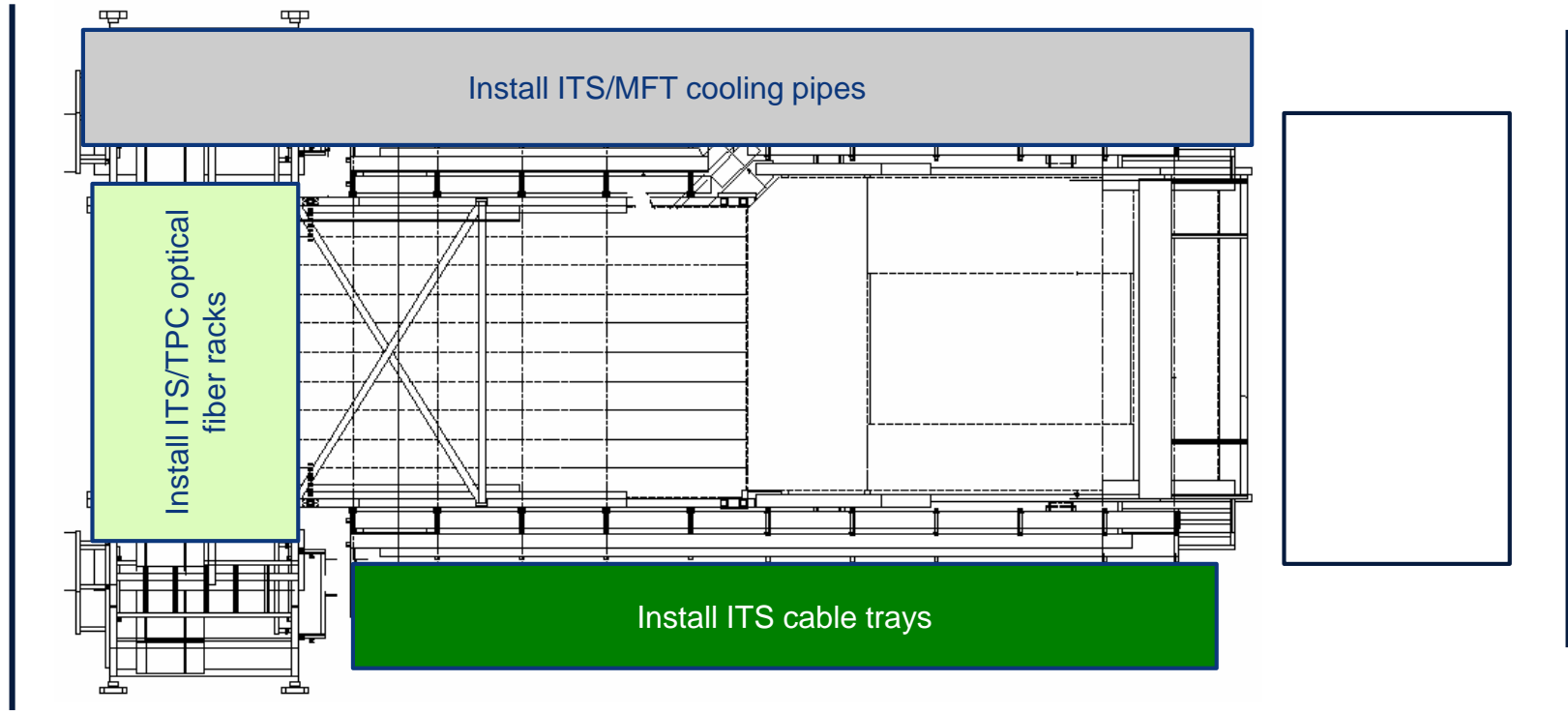

Miniframe activities w31 – Tue 30 Jul 2019

Remove Rampower material in order to make room for TRD platform

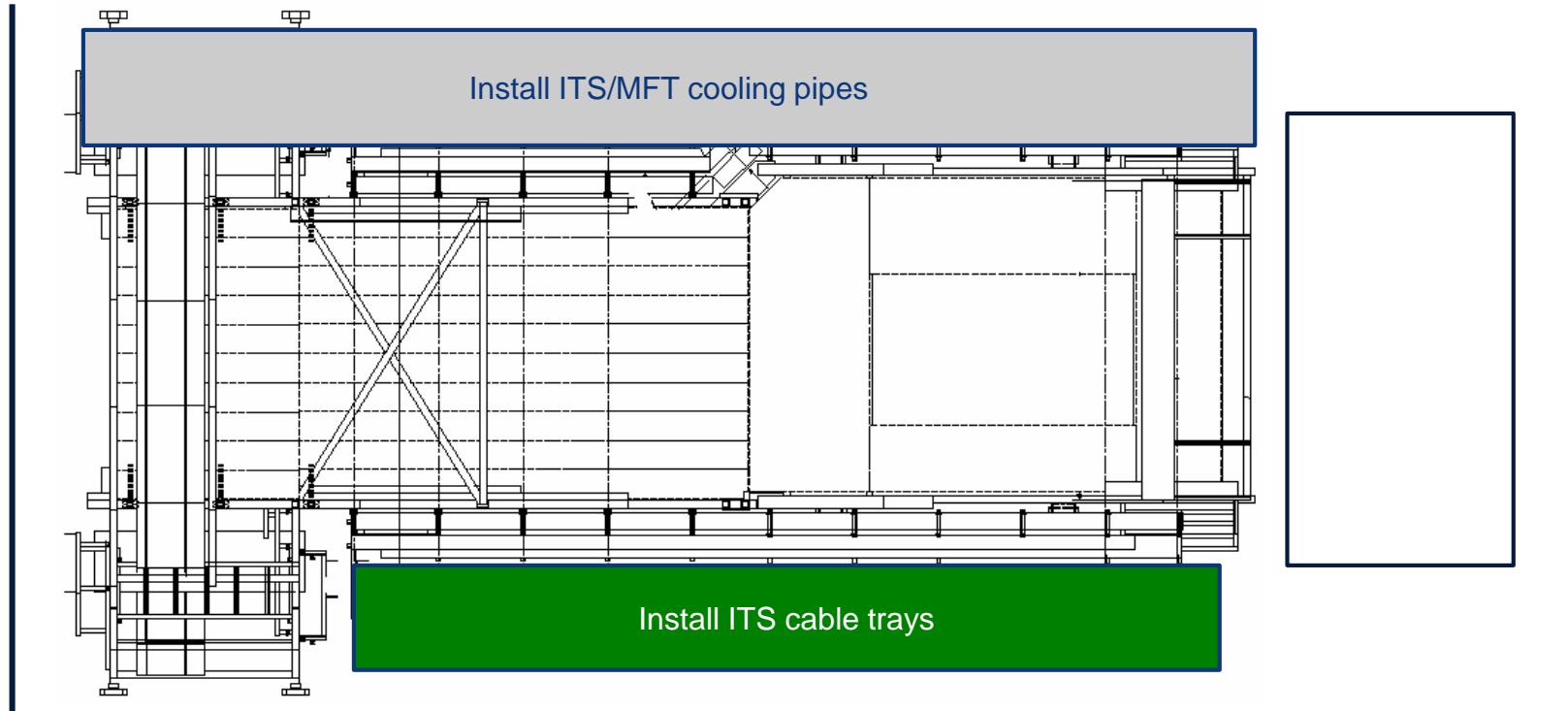

Miniframe activities w31 – Wed 31 Jul 2019

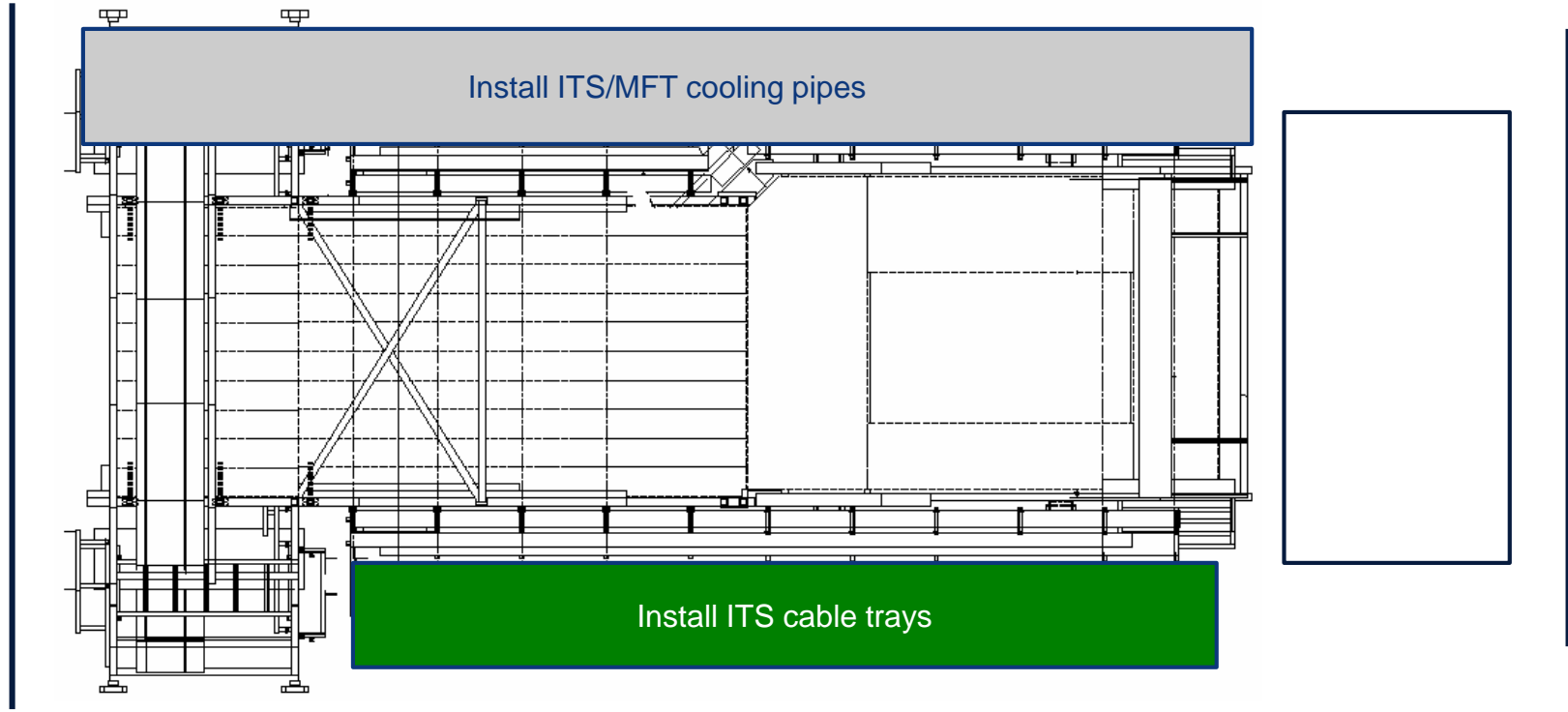

Miniframe activities w31 – Thu 1 Aug 2019

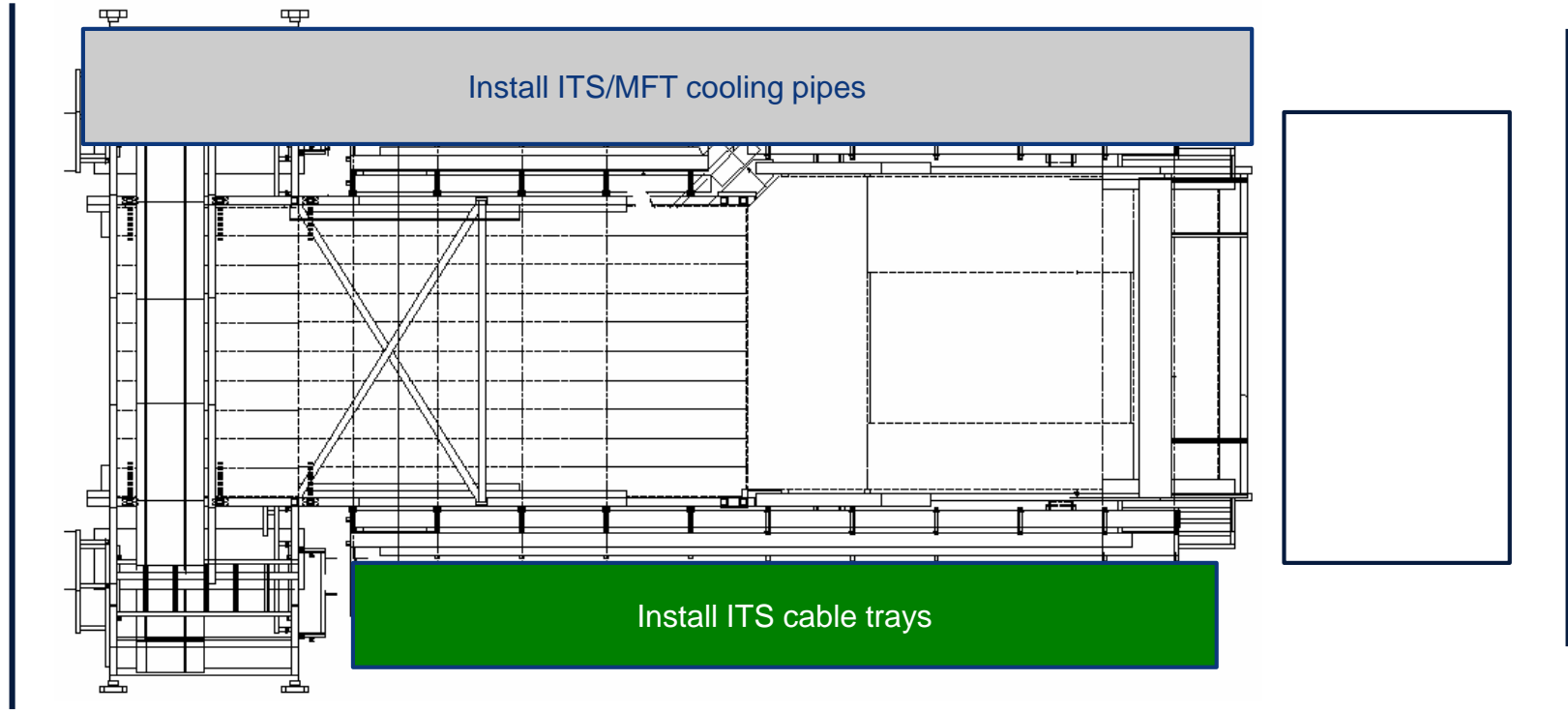

Miniframe activities w31 – Fri 2 Aug 2019

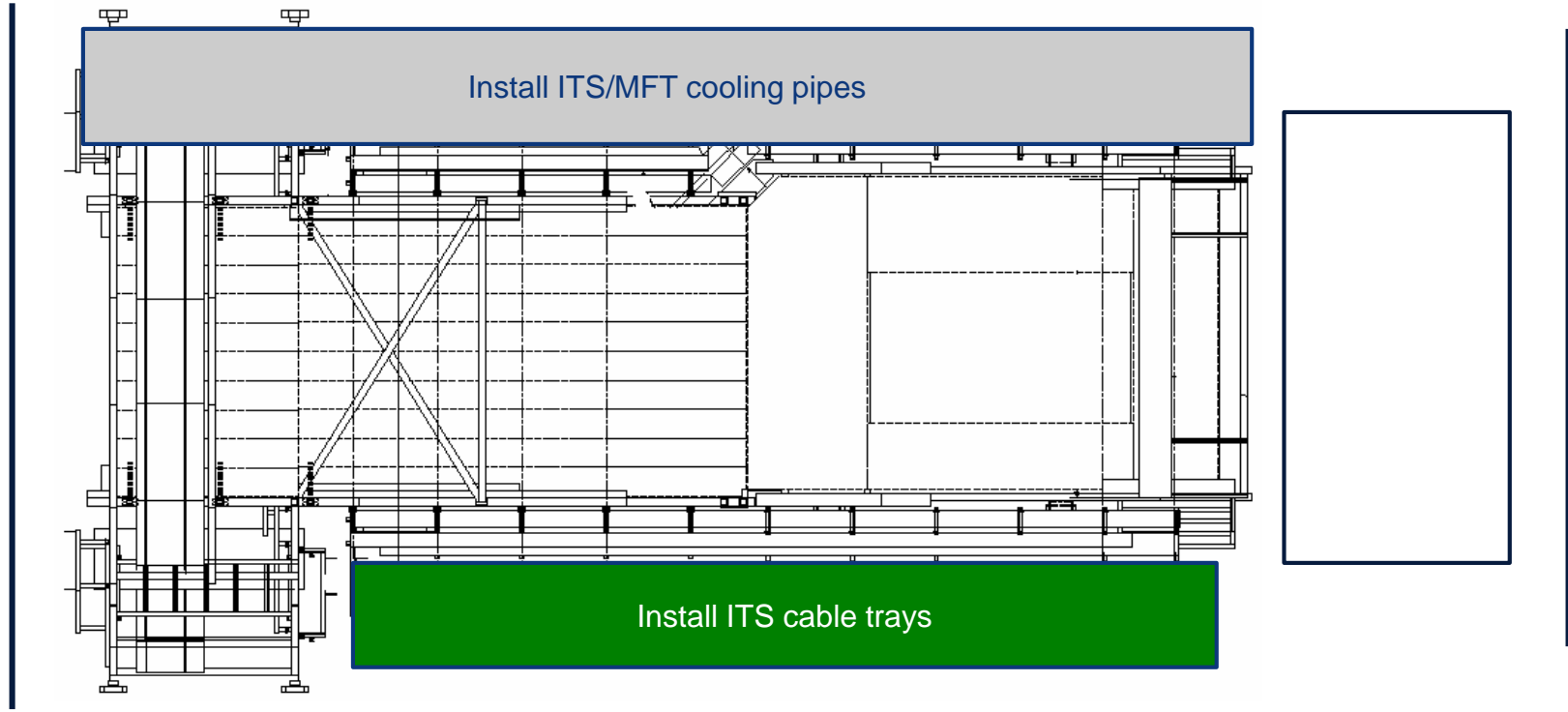

Day-by-day sequence w32

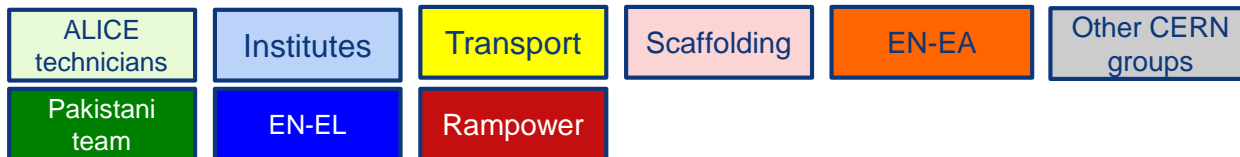

UX25 activities w32 – Mon 5 Aug 2019

CR0: installation mobile elevator + VIC (14:30)

ALTEAD: remove CV equipment (part 2)

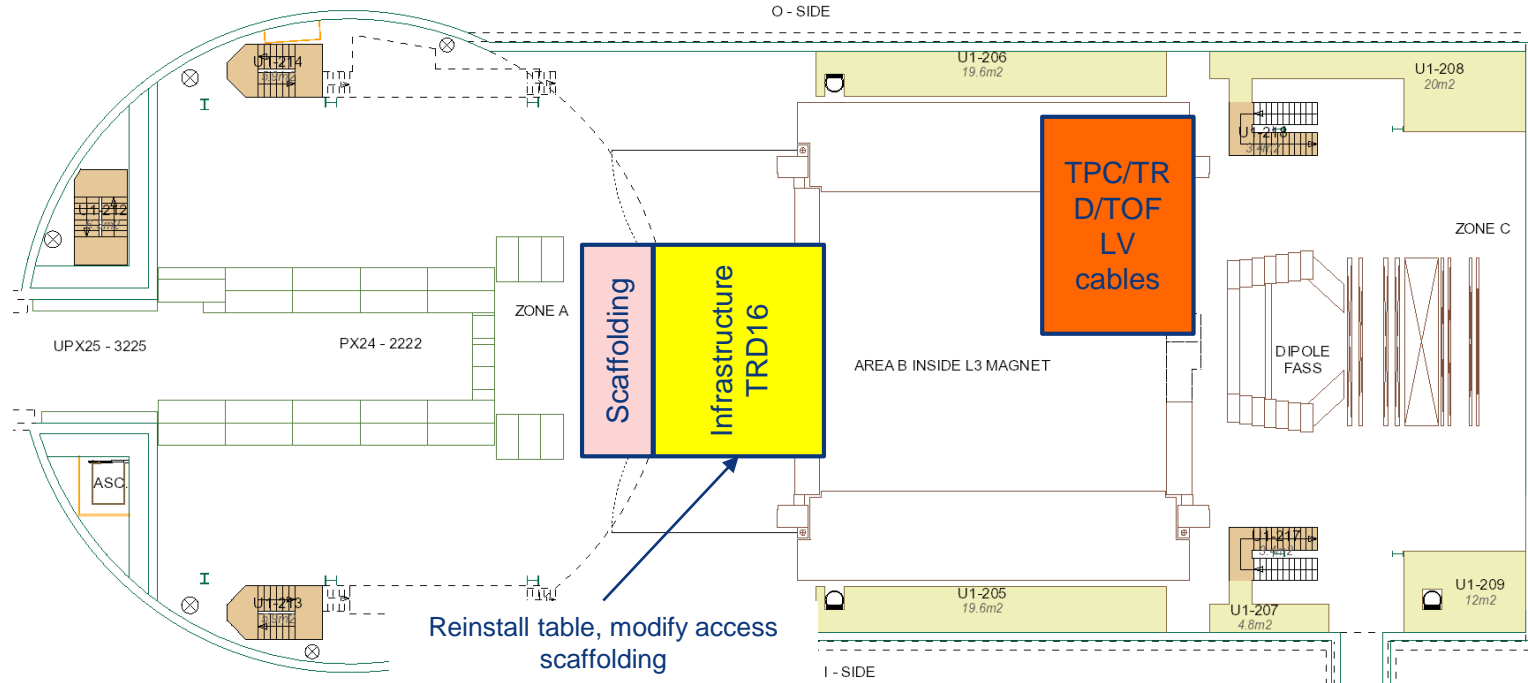

UX25 activities w32 – Tue 6 Aug 2019

CR0: delivery 8 AHUs, installation 4AHUs above IT3

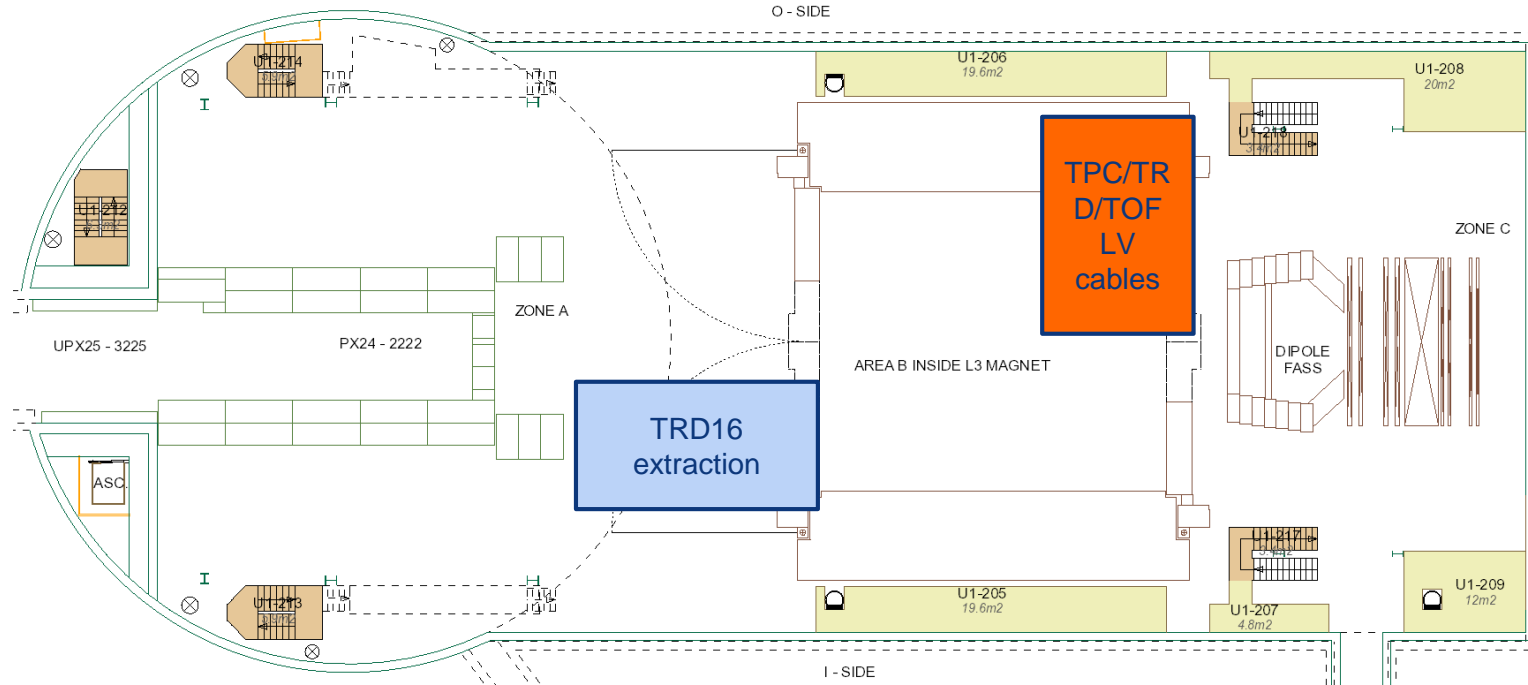

UX25 activities w32 – Wed 7 Aug 2019

CR0: installation IT4 + 4 AHUs

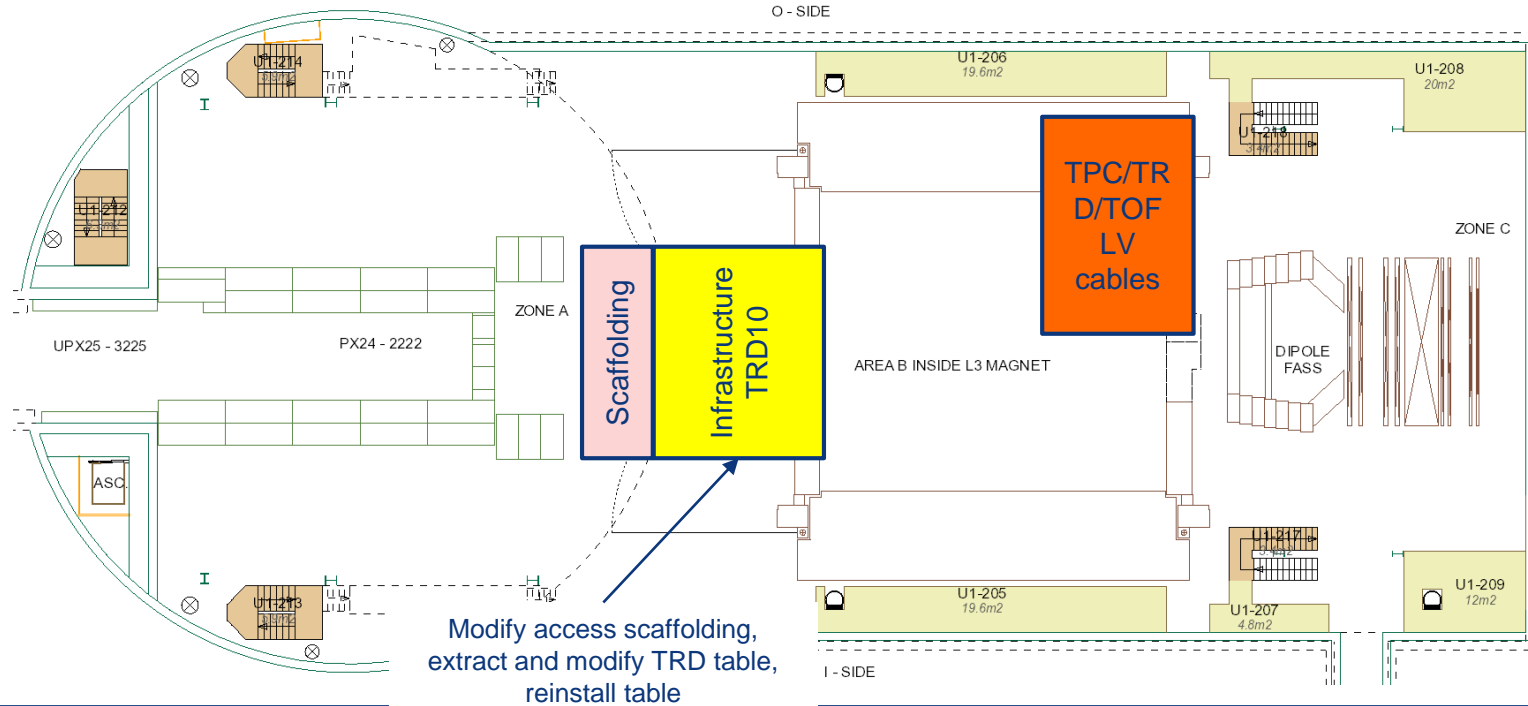

UX25 activities w32 – Thu 8 Aug 2019

SNIFFER test – inhibit link to DSS and cavern evacuation

CR0: installation various parts from the roof (AUTOMATION)

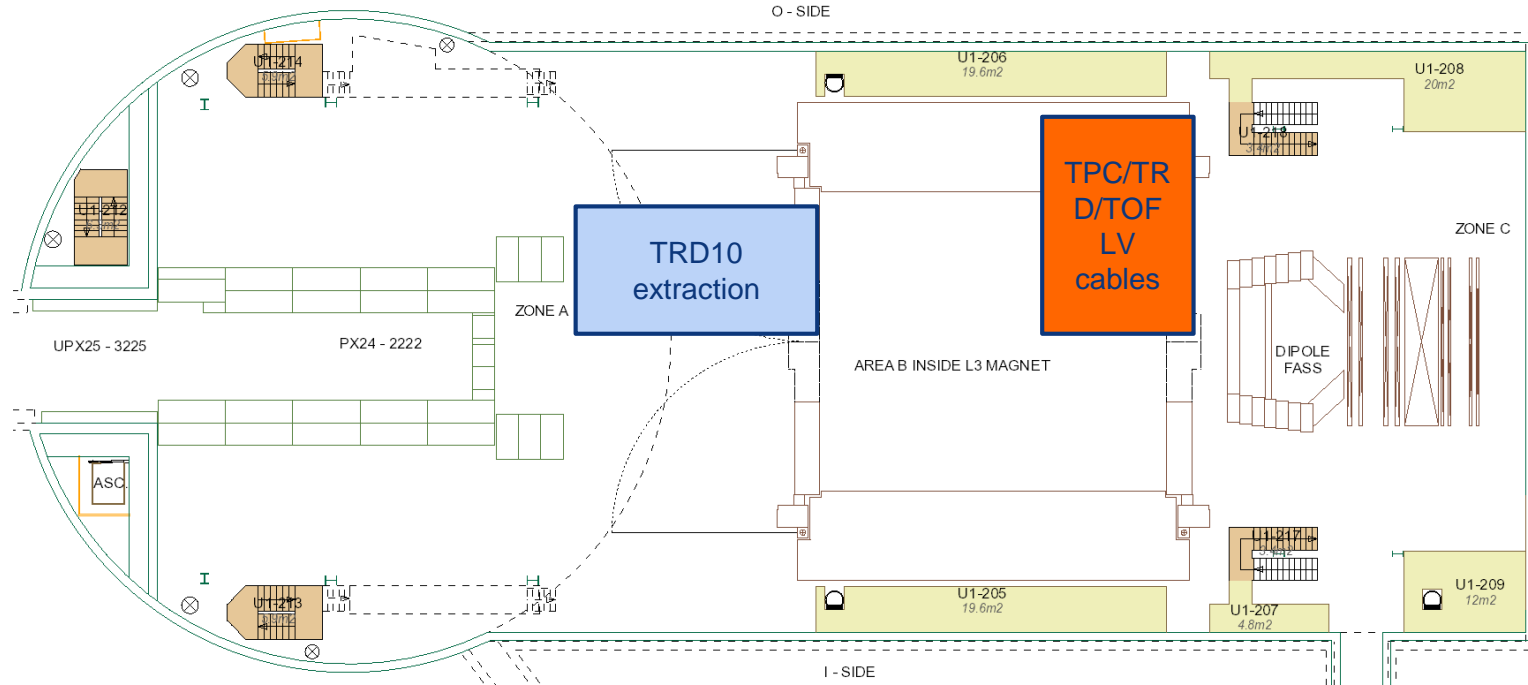

UX25 activities w32 – Fri 9 Aug 2019

CR0: removal mobile crane

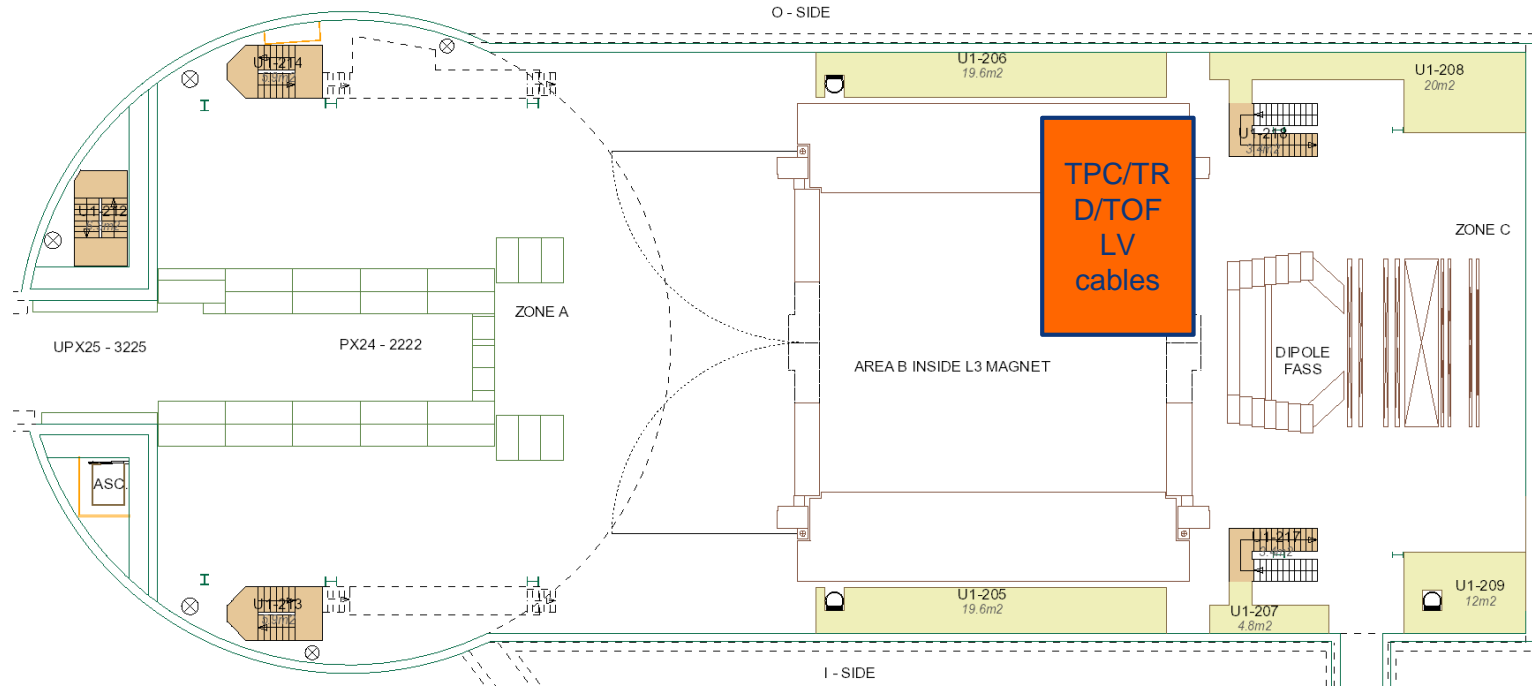

SXL2 activities w32 – Mon 5 Aug 2019

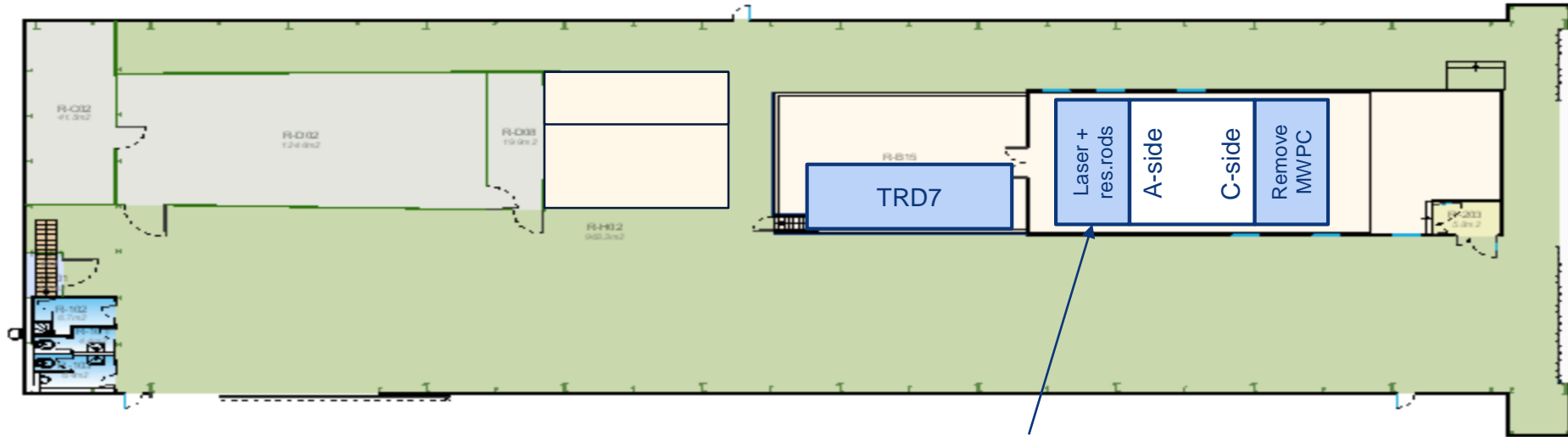

Connect and operate laser. On A side: Reinstall laser camera boxes. Reinstall prism and splitter boxes. Align with laser

+

Modification of 4 resistor rods (new flanges, HV supply for last strip)

SXL2 activities w32 – Tue 6 Aug 2019

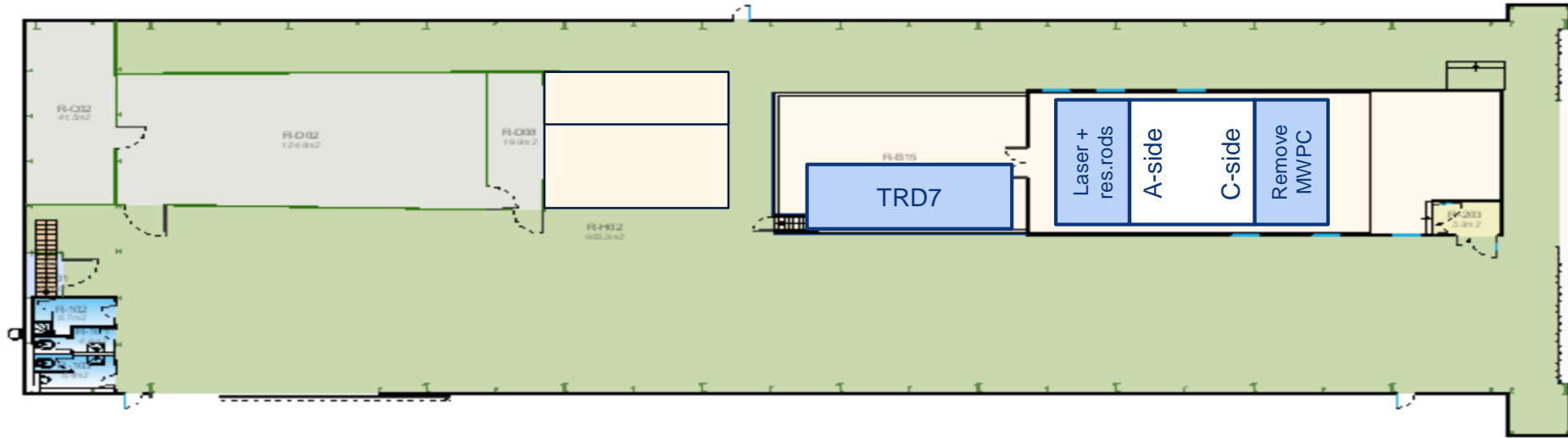

SXL2 activities w32 – Wed 7 Aug 2019

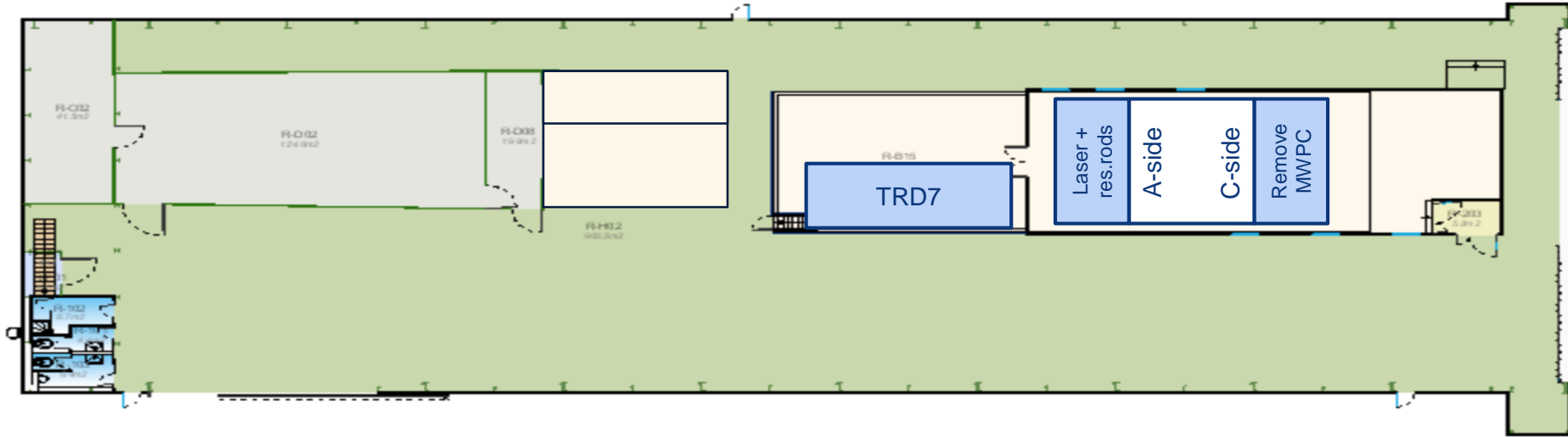

SXL2 activities w32 – Thu 8 Aug 2019

ALTEAD + TRD: extract TRD16 from rotator, put it into blue frame and into swimming pool

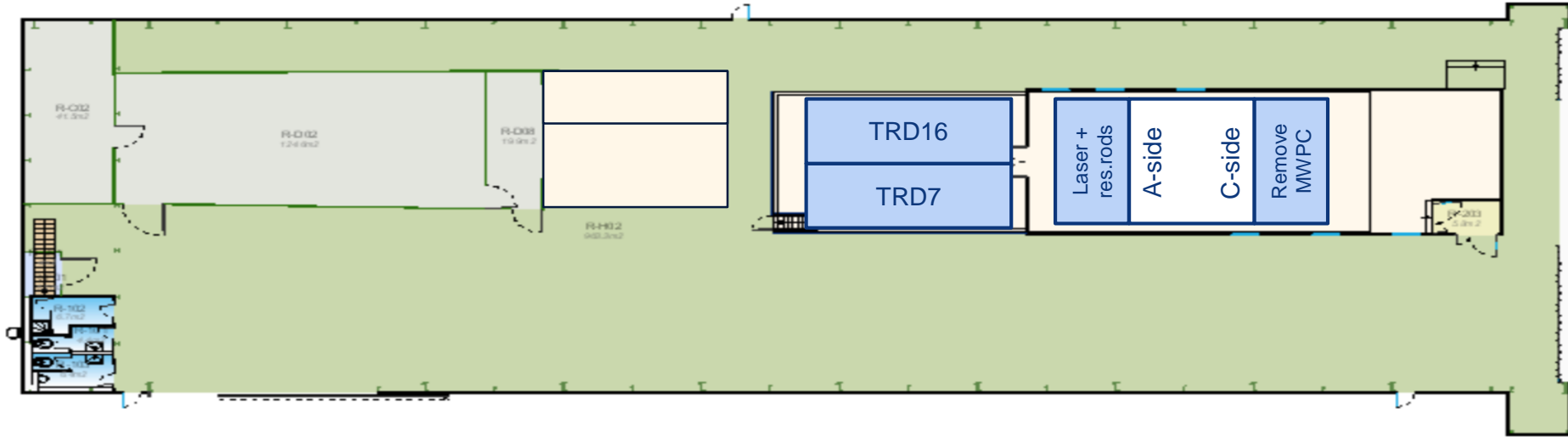

SXL2 activities w32 – Fri 9 Aug 2019

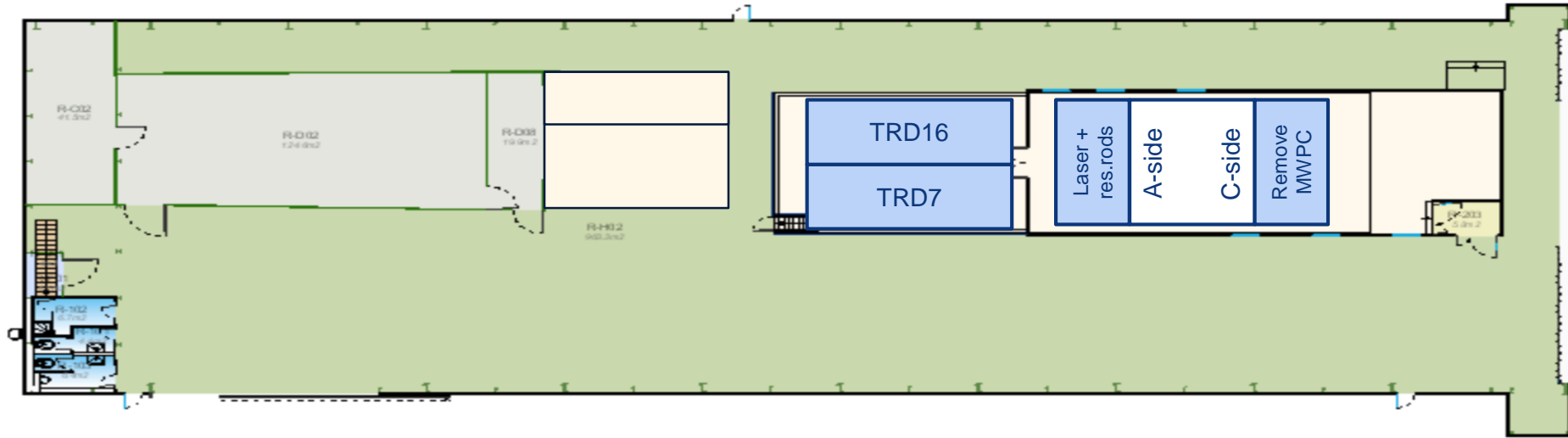

Miniframe activities w32 – Mon 5 Aug 2019

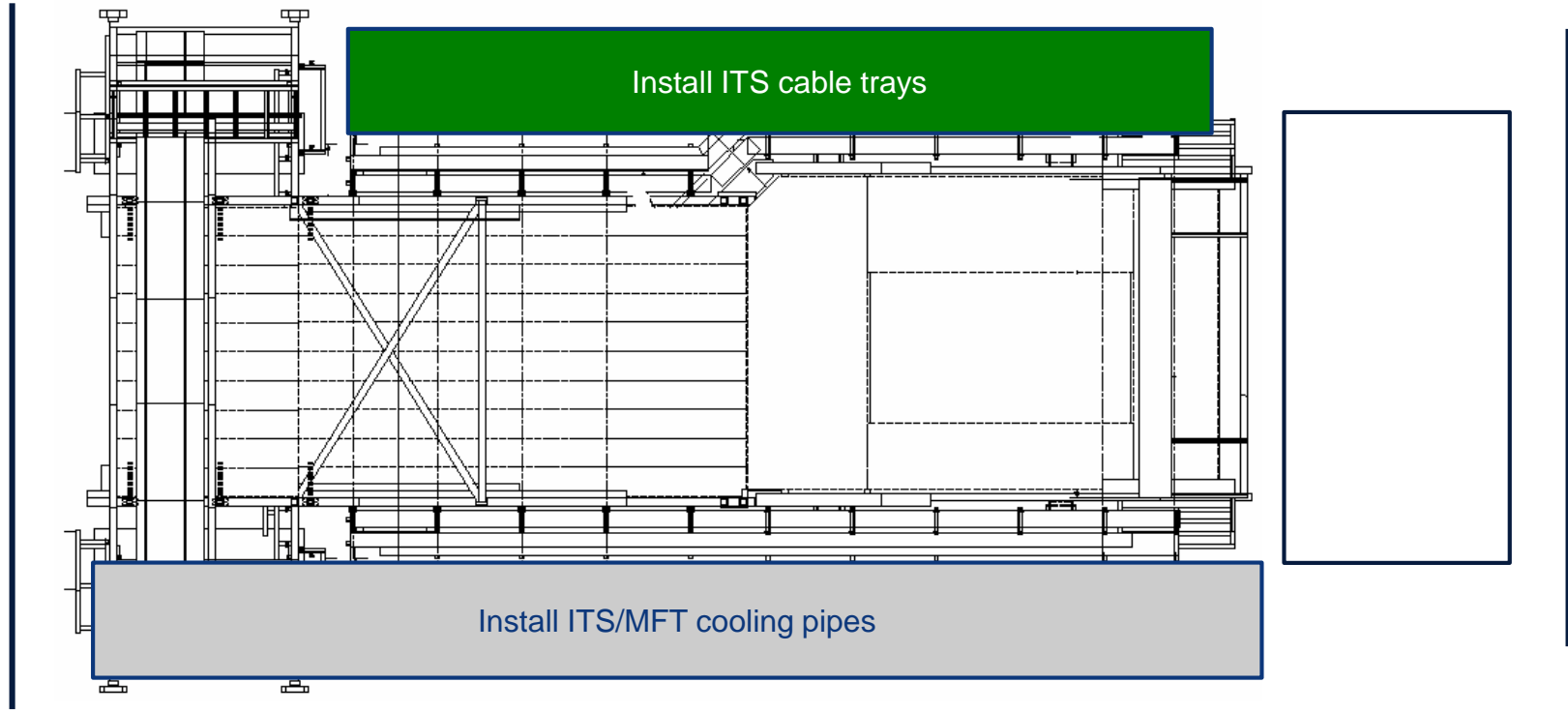

Miniframe activities w32 – Tue 6 Aug 2019

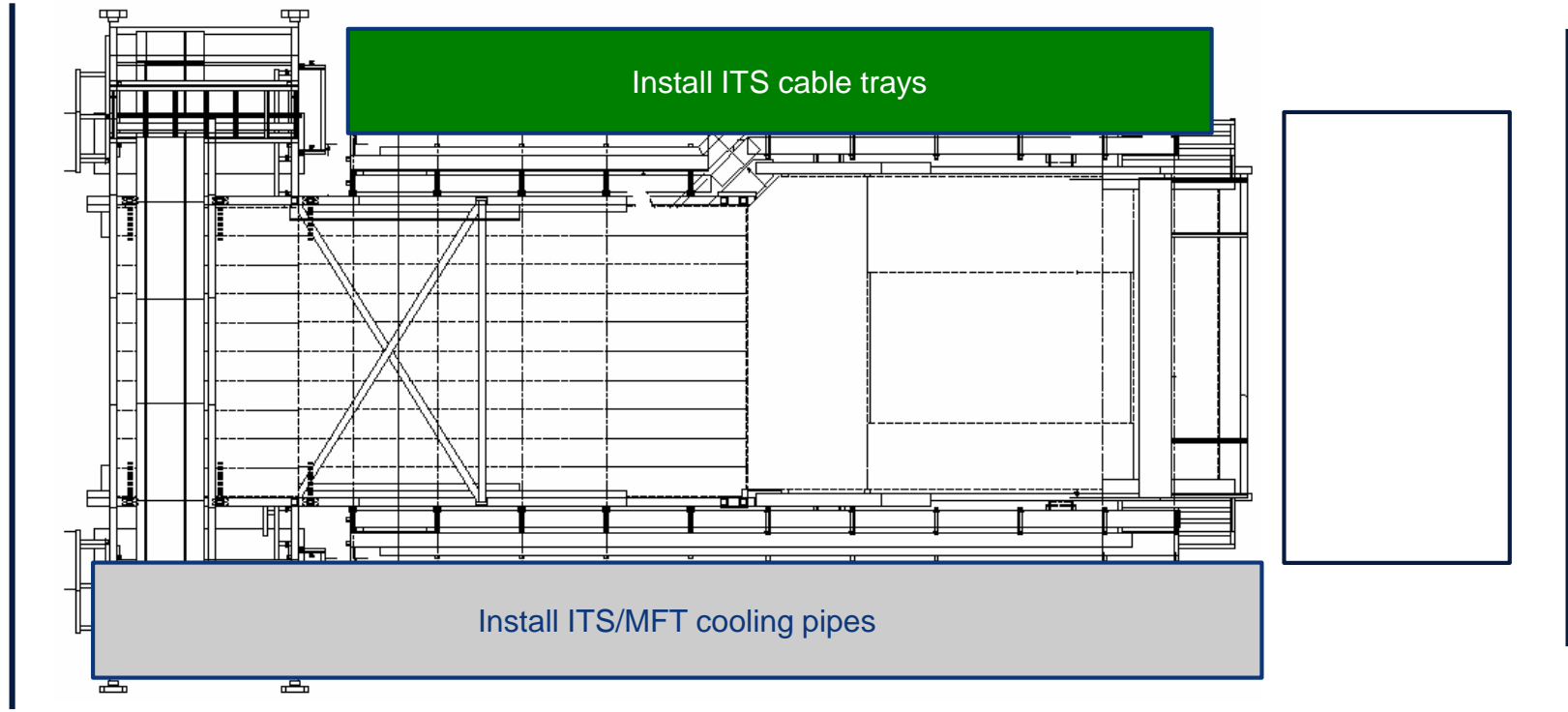

Miniframe activities w32 – Wed 7 Aug 2019

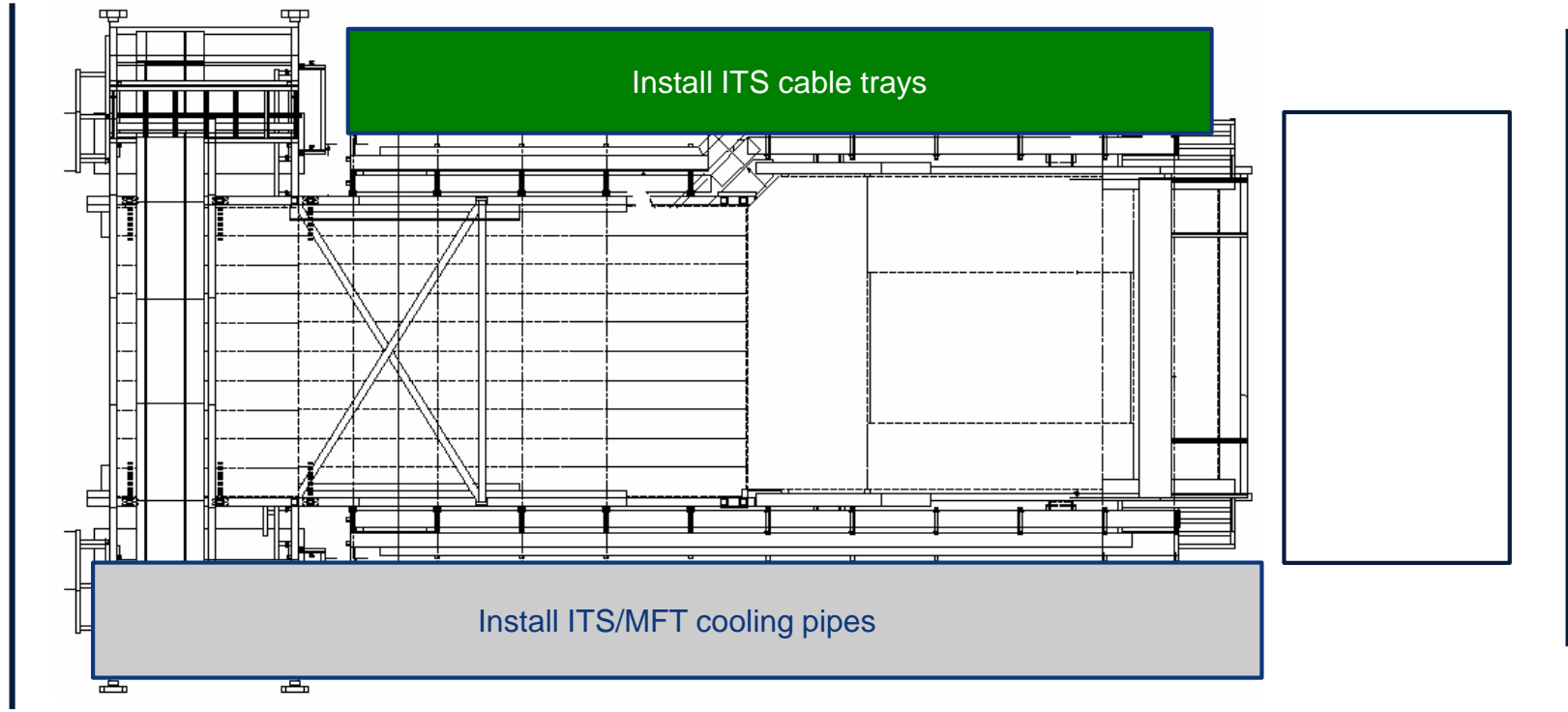

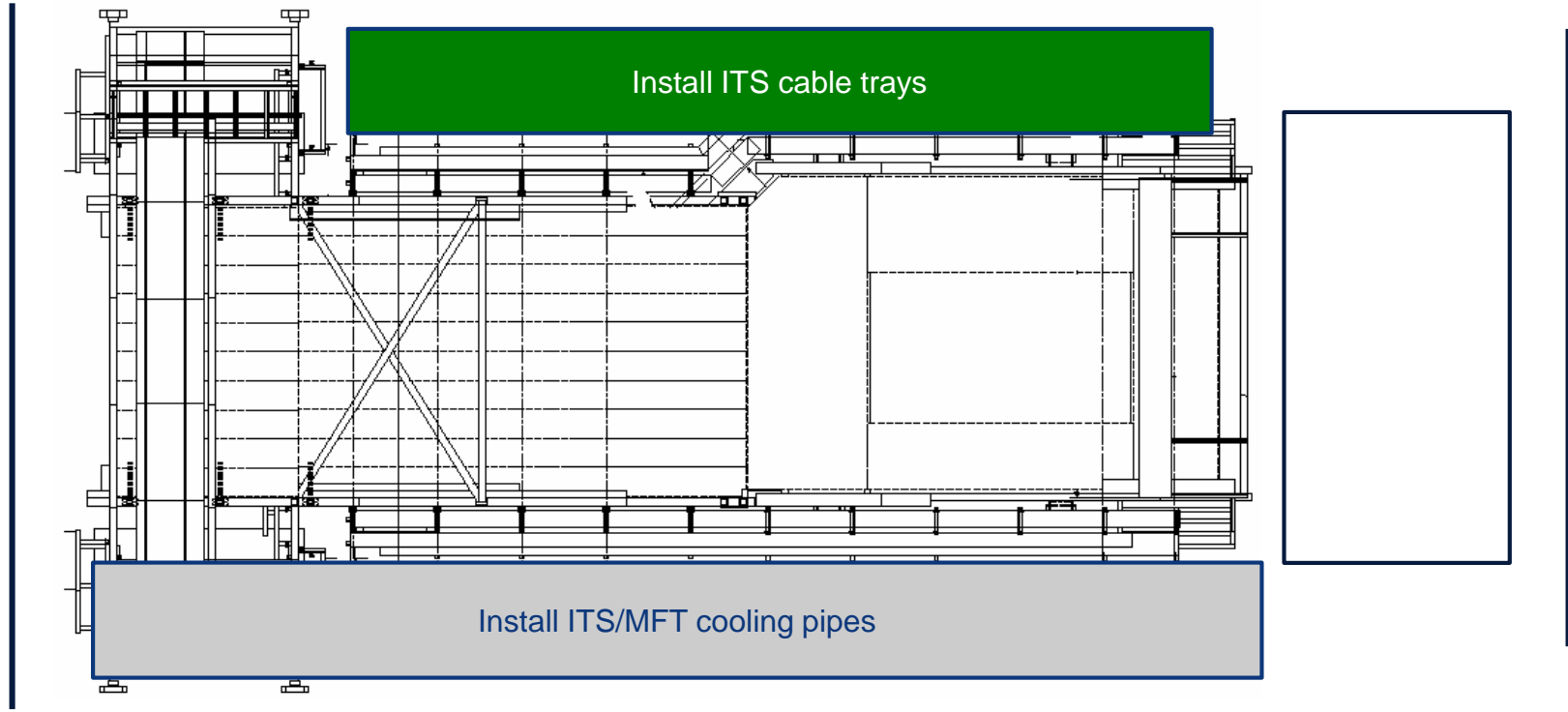

Miniframe activities w32 – Fri 9 Aug 2019

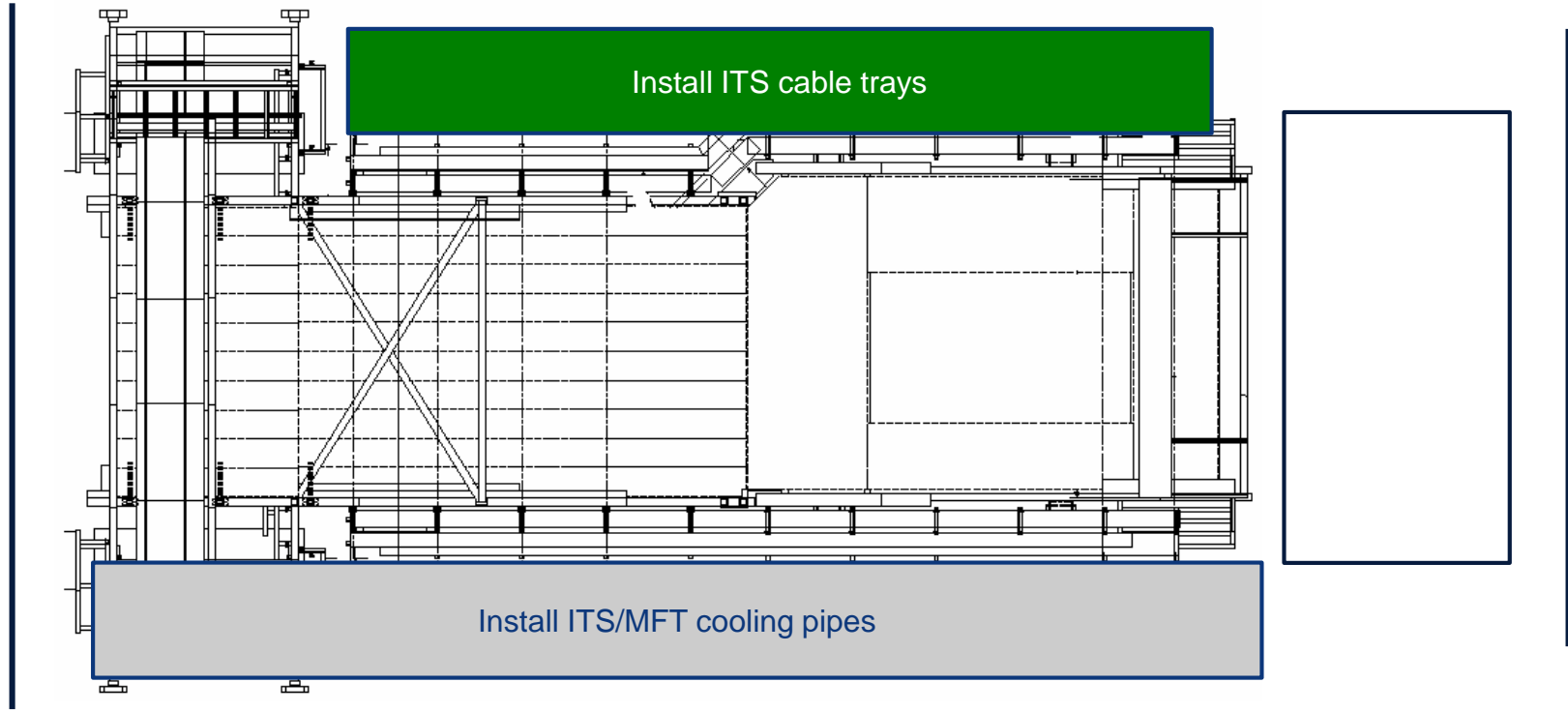

Meetings in August

- Next planning meeting on Friday 30 August
- Daily meetings will resume on Monday 26 August