

# LS2 planning meeting

A.Tauro



# LS2 master plan (v31)



| Begin date | End date | Dur... |
|------------|----------|--------|
| 3/12/18    | 21/12/18 | 15     |
| 24/12/18   | 5/3/19   | 52     |
| 6/3/19     | 18/2/20  | 250    |
| 7/1/19     | 27/3/20  | 320    |
| 7/3/19     | 29/3/19  | 17     |
| 8/4/19     | 25/10/19 | 145    |
| 28/10/19   | 6/12/19  | 30     |
| 19/2/20    | 1/5/20   | 53     |
| 4/5/20     | 12/6/20  | 30     |
| 15/6/20    | 4/9/20   | 60     |
| 7/9/20     | 11/9/20  | 5      |
| 14/9/20    | 6/11/20  | 40     |
| 9/11/20    | 19/2/21  | 75     |

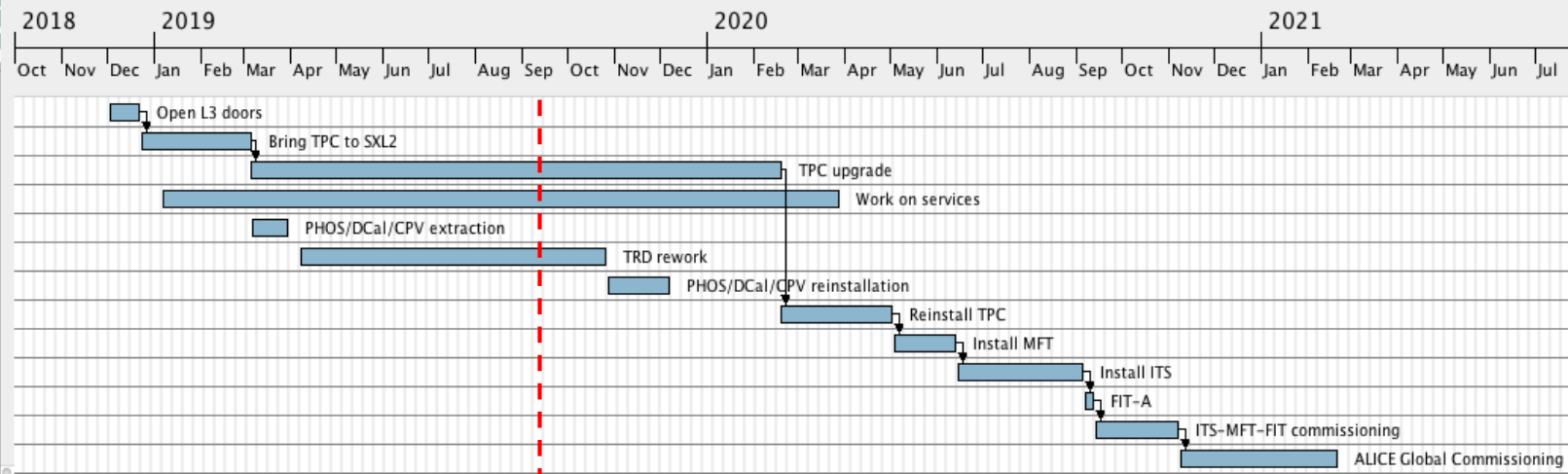

# EN-EL interventions

- Test secours (10 min): 19 Dec 2019 from 8:00 AM to 11:00 AM
- 18kV, 3.3kV and LV network maintenance:
  - Mon 20 to Wed 22 Jan 2020: 3 days no general services - **no access on site (both surface and underground)**
  - Thu 23 to Fri 24 Jan 2020: 2 days "Limited access" → details to be worked out
- AUG on Monday 27 January 2020 - **no access on site (both surface and underground)**
- Auto transfer test: 27-29 Apr 2020
- BIW test: 5 and 6 Oct 2020 from 18:00 to 00:00 – **no access underground**

# EN-CV interventions

- **Big maintenance:**

- SF: from Nov 2019 to mid Jan 2020. NO impact on ALICE as both magnets will be OFF.
- UW: **stop UX mixed water** for 2 days in week 40/2019 (October).
- SU: various small perturbations + 1 day **stop all cooling UX** + 1 day **stop all cooling SXL2** in week 16/2020 (April).

- **Small maintenance:**

- UW: from mid Aug 2020 to mid Sep 2020. **Stop mixed water UX** for 1 day in week 37/2020 (September).
- SF+SU: weeks 45-47/2020: cleaning towers (stop SF 1 week) + 1 day **stop all cooling UX**.

- **Ventilation:**

- SG2: w7/2019 - Done
- Gas extraction: w8/2019 - Done
- UX25 cavern: May 2020 (tbc)
- MCH and MTG: Apr 2020 (tbc)
- L3: Apr 2020 (tbc)
- ITS: Apr 2020 (tbc)

- **Raw water:**

- Test after Apr 2019. Short interruption (1 day), can be used tap water during the test.

# UX access restrictions

- **No access to A-side from 19<sup>th</sup> to 20<sup>th</sup> September (close low-beta platform)**





# TRD schedule

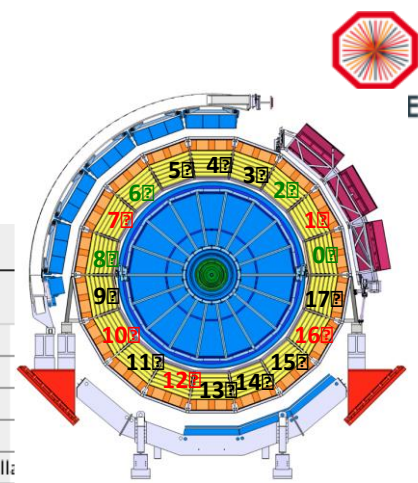
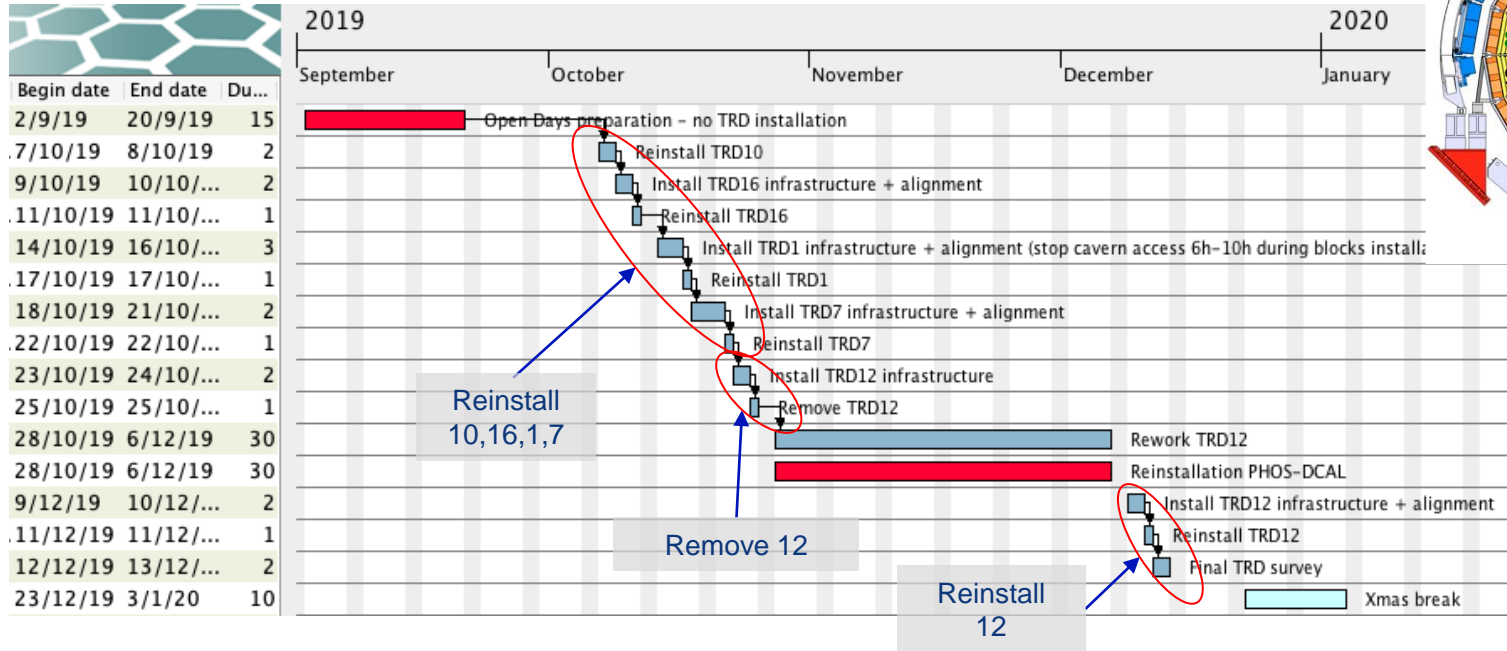



# TPC upgrade sequence

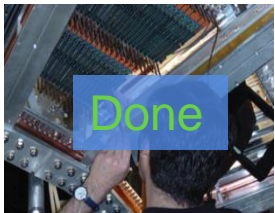

Remove Services and FEE  
(outside cleanroom)



Uninstall MWPC ROC



Install GEM ROC



Install new FEC + test



Transportation to SX2



TPC in cleanroom.  
Cleaning & irradiation tests

7 Mar

11 Apr



FC HV infrastructure  
modification

25 Apr (A)  
5 Aug (C)

13 May (A)  
16 Aug (C)



Survey, sealing,  
overpressure test

14 Jun (A)  
25 Aug (C)

5 Jul (A)  
9 Sep (C)



Pre-commissioning with  
cosmic, Laser, pulser, Xray

1 Oct (A)  
22 Oct (C)

31 Oct (A)  
4 Dec (C)

18 Feb 2020

# Copper cables (EN-EA)

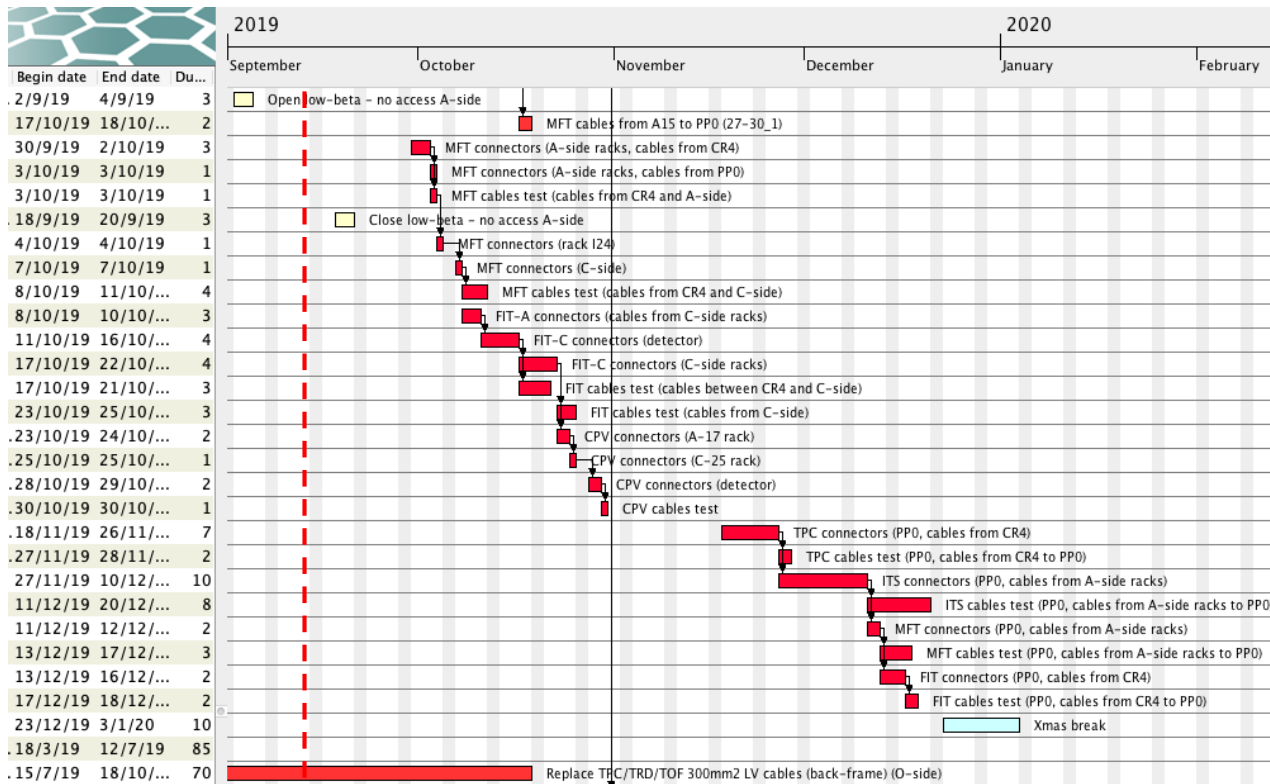

# Optical fibers (EN-EL)

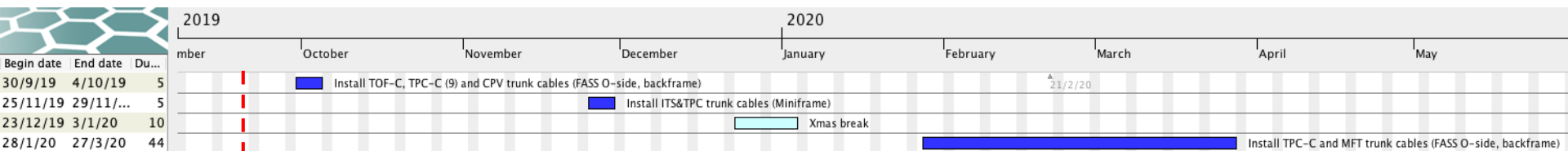

# Miniframe planning

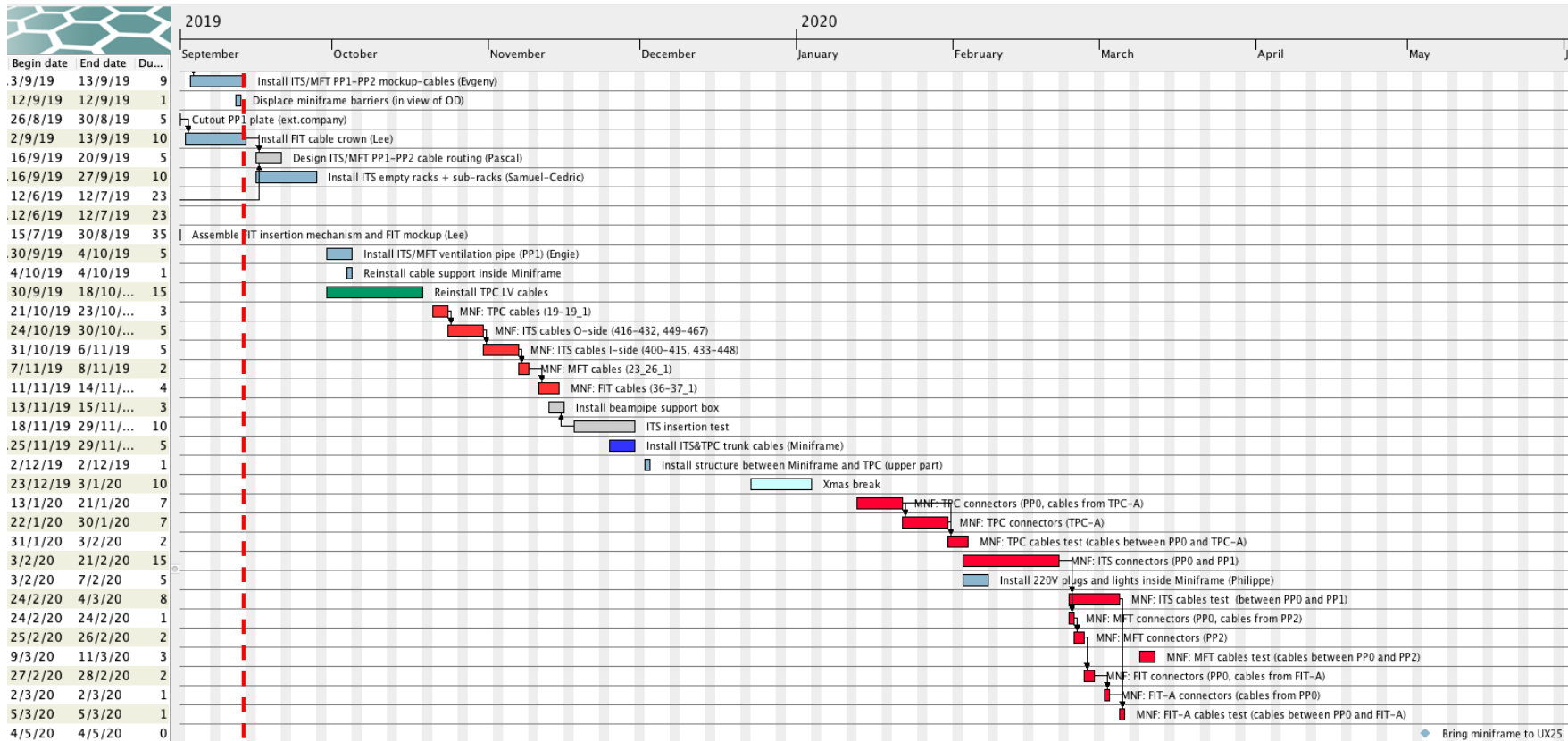

# CR0 planning

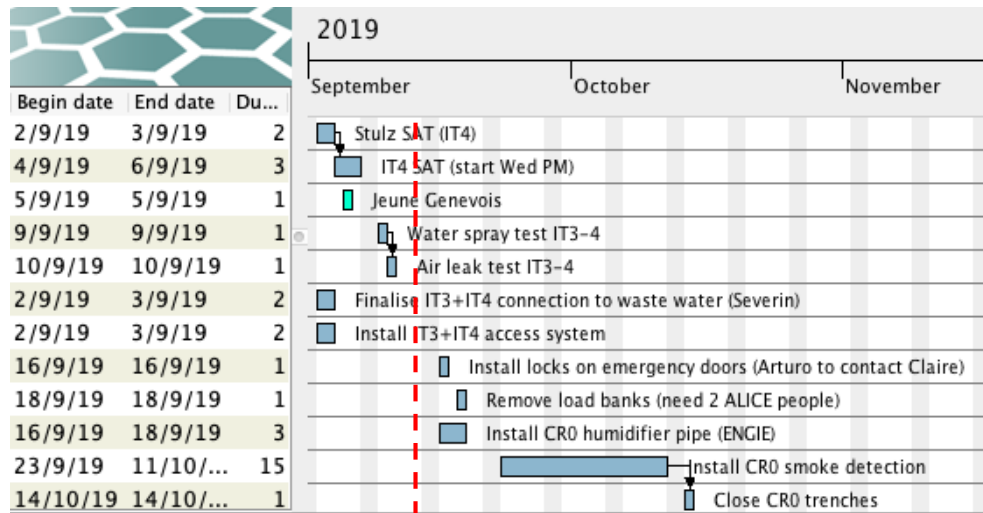

# Day-by-day sequence w36

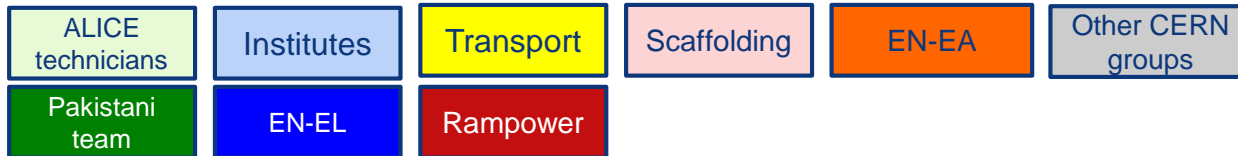

# UX25 activities w36 – Mon 2 Sep 2019

No access to A-side (up to L3 magnet) due to transport of blocks. No visits before 18:00

Cavern lift maintenance: no cavern access between 6:00 AM and 8:00 AM

CR0: Stulz SAT IT4

CR0: install access system IT3-4 (Mon-Wed)

OD: installation restaurant and boarding tents on the parking

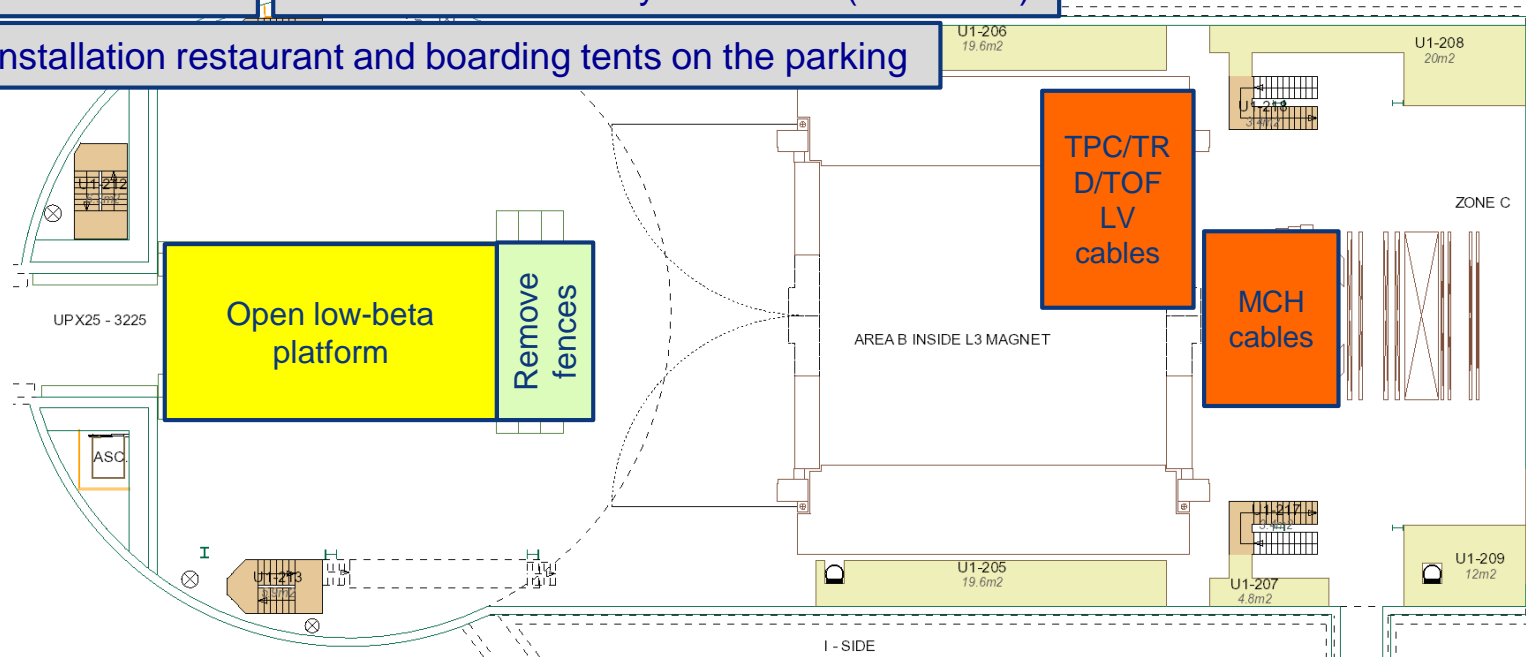

# UX25 activities w36 – Tue 3 Sep 2019

No access to A-side (up to L3 magnet) due to transport of blocks. No visits before 18:00

CR0: Stulz SAT IT4

CR0: close roxtecs in IT4 (Philippe)

VIP visit (Indian government) at 16:40 – 17:30

Delivery scaffolding OD (15 pallets)

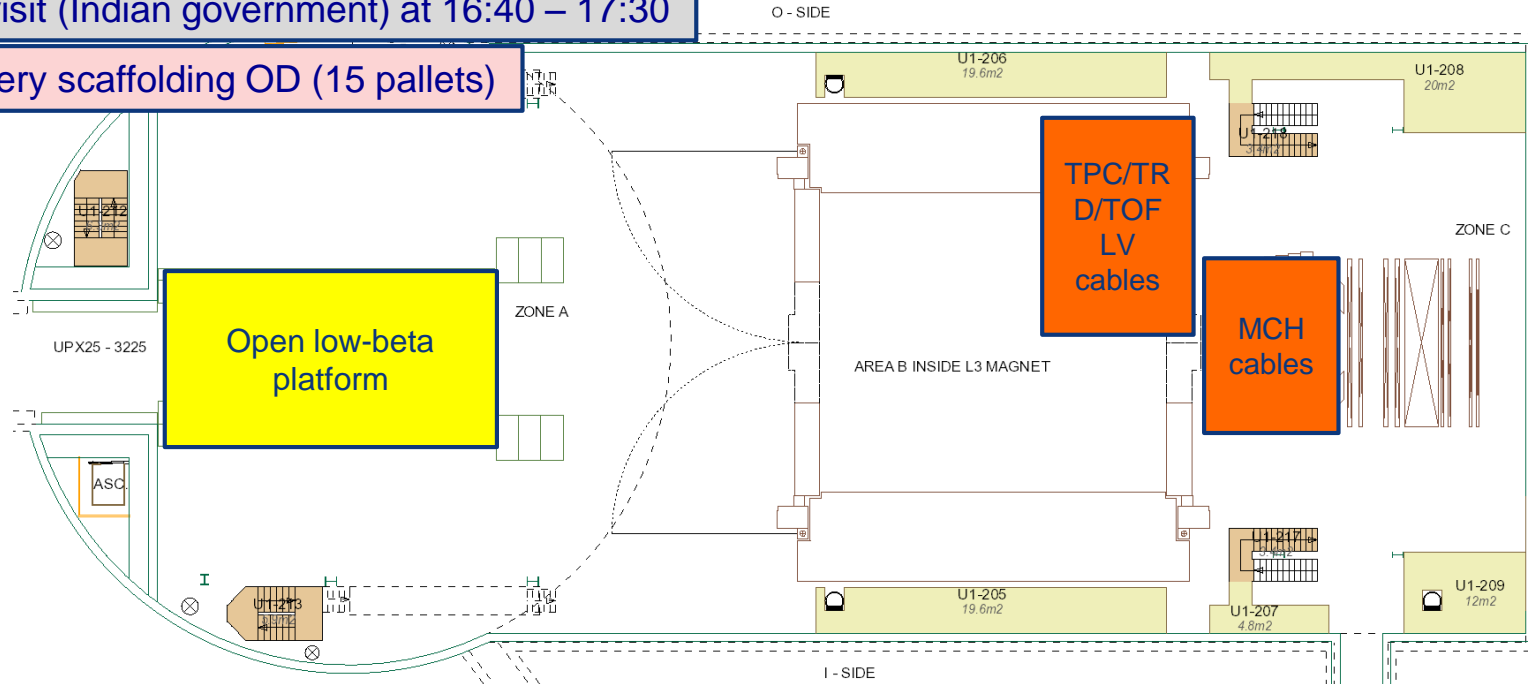



# UX25 activities w36 – Wed 4 Sep 2019

VIP visits (Thailand princess. Tapan, Luciano and Federico) at 14:00

CR0: 48h SAT IT4

CR0: acoustic noise measurement at 16:00 (HSE)

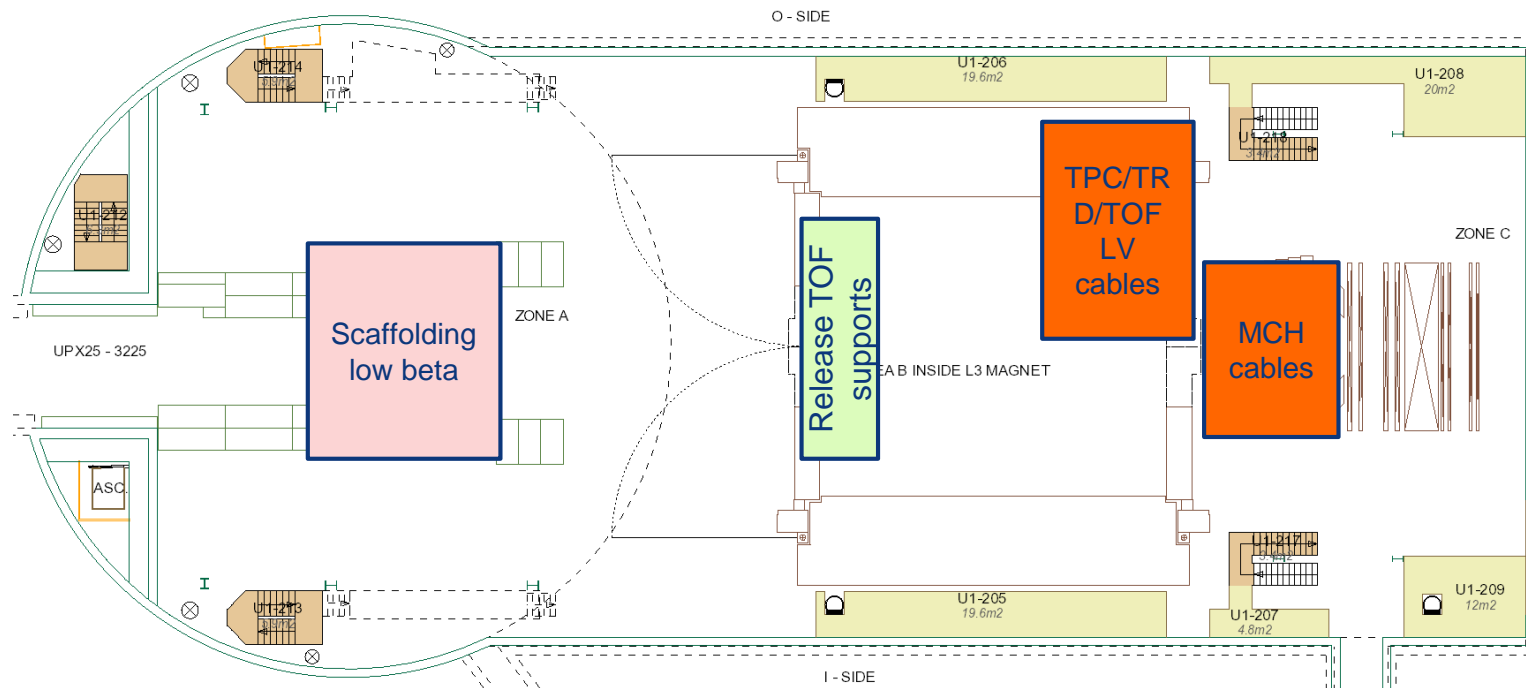

# UX25 activities w36 – Thu 5 Sep 2019

CERN official holiday (Jeune Genevois)

CR0: 48h SAT IT4

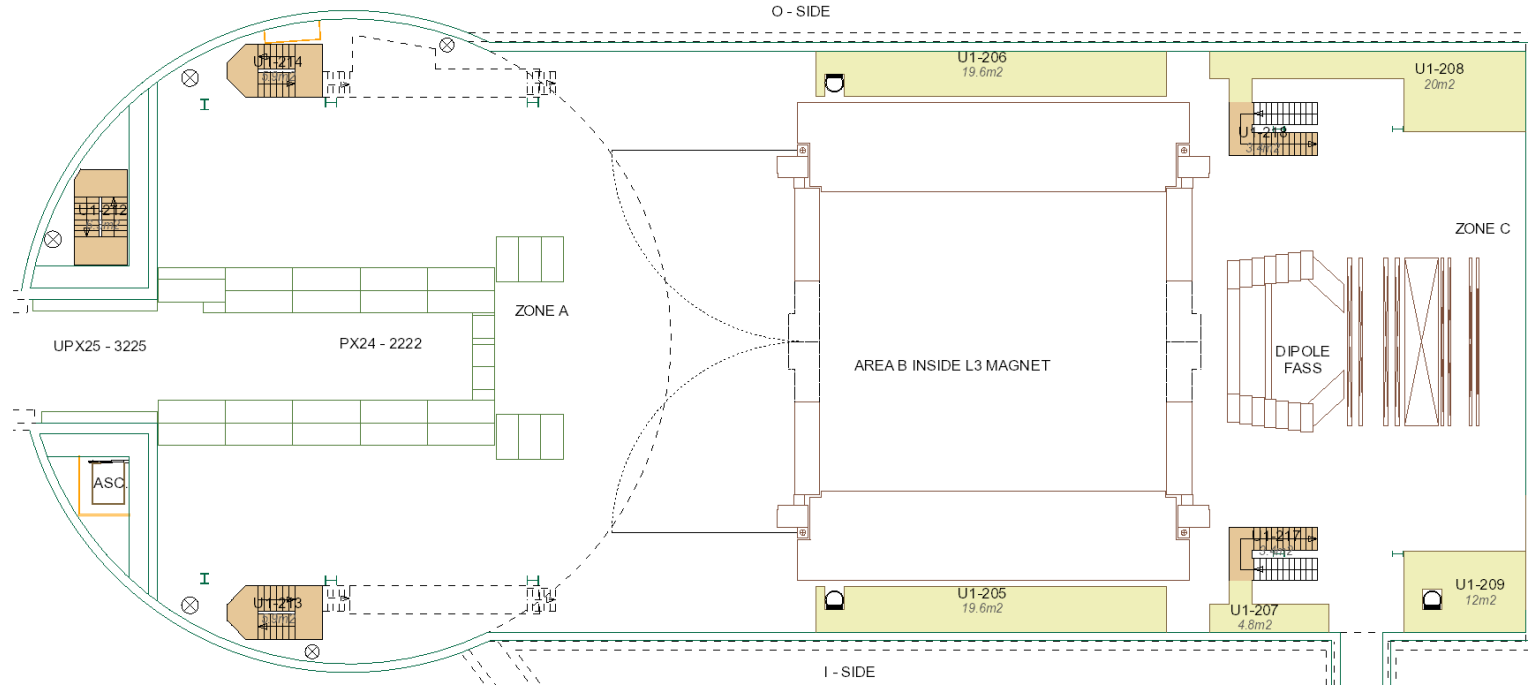

# UX25 activities w36 – Fri 6 Sep 2019

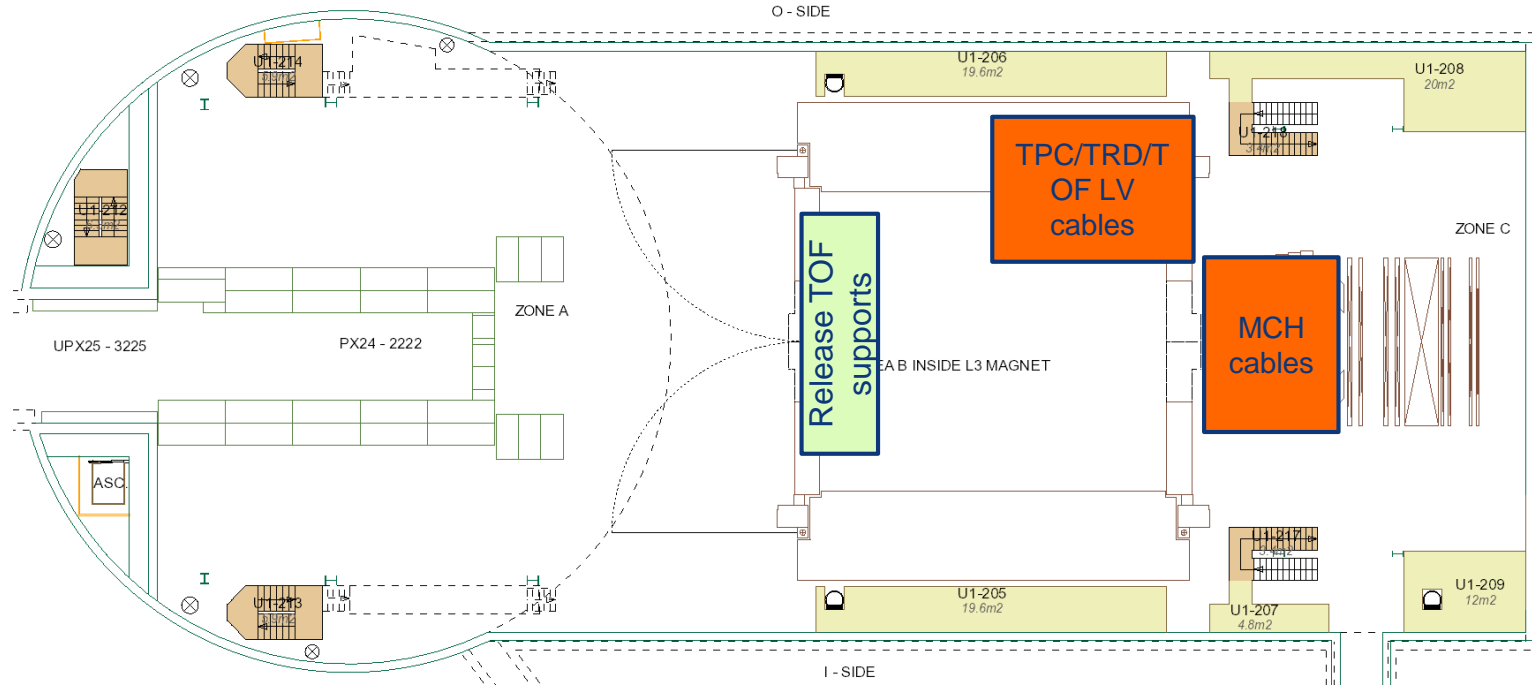

# SXL2 activities w36 – Mon 2 Sep 2019

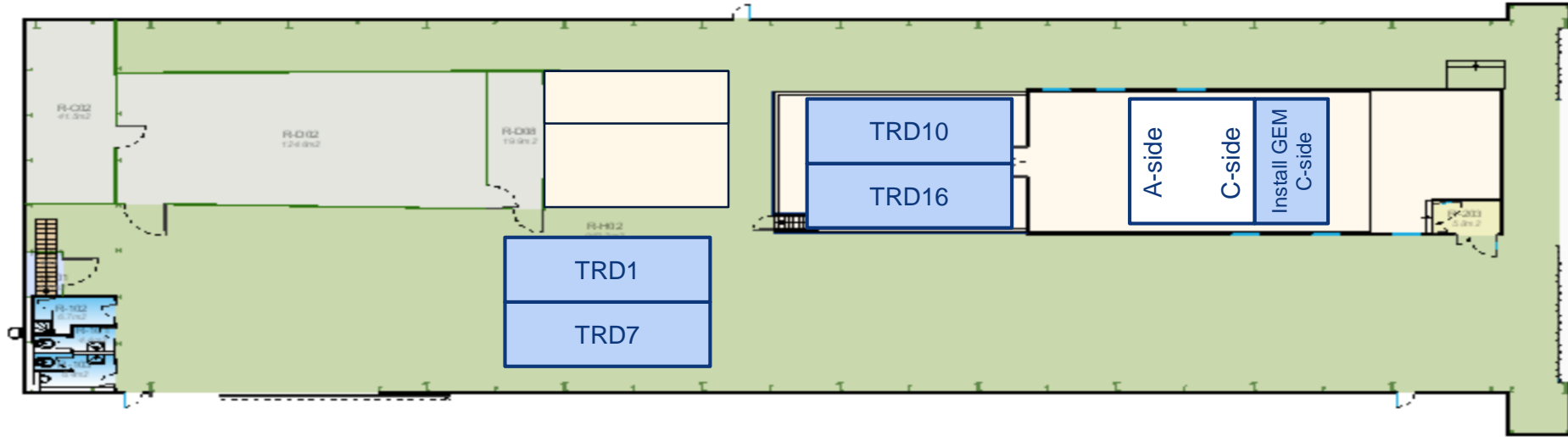

# SXL2 activities w36 – Tue 3 Sep 2019

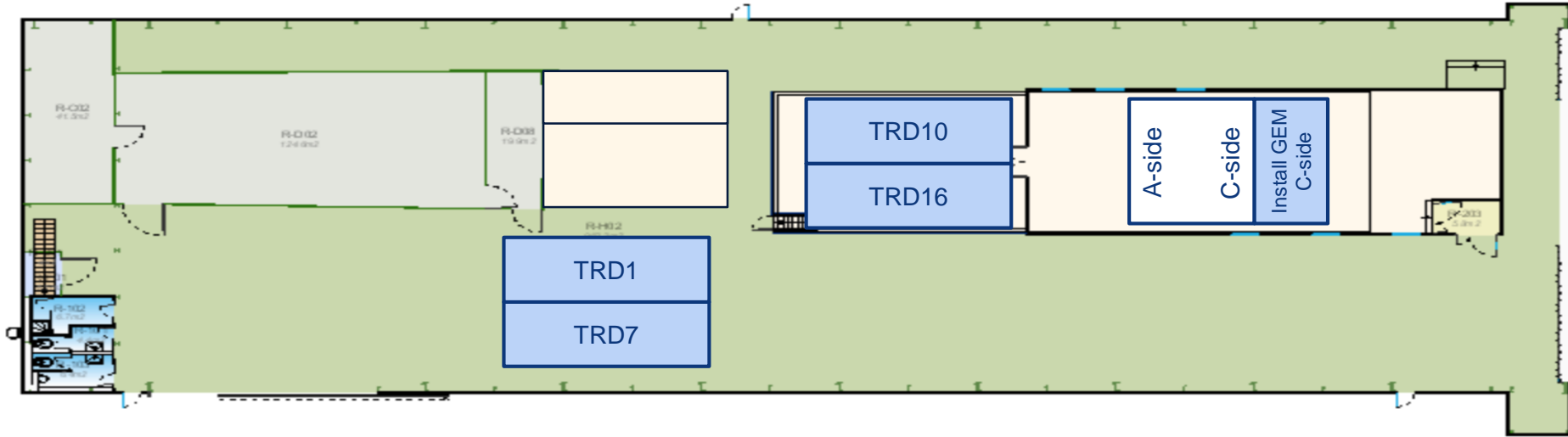

# SXL2 activities w36 – Wed 4 Sep 2019

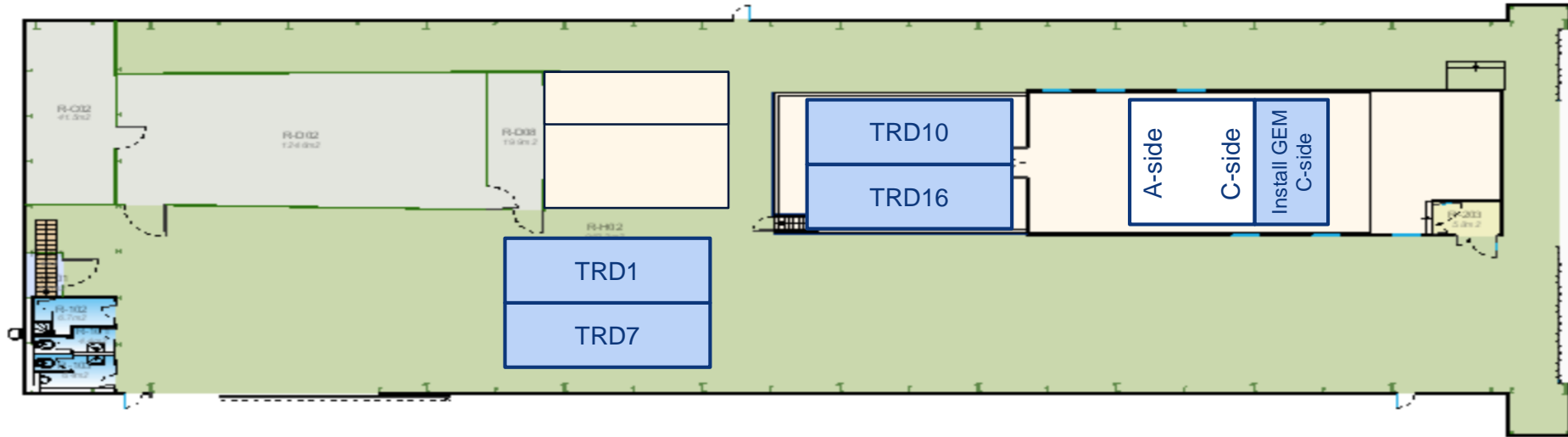

# SXL2 activities w36 – Thu 5 Sep 2019

CERN official holiday (Jeune Genevois)

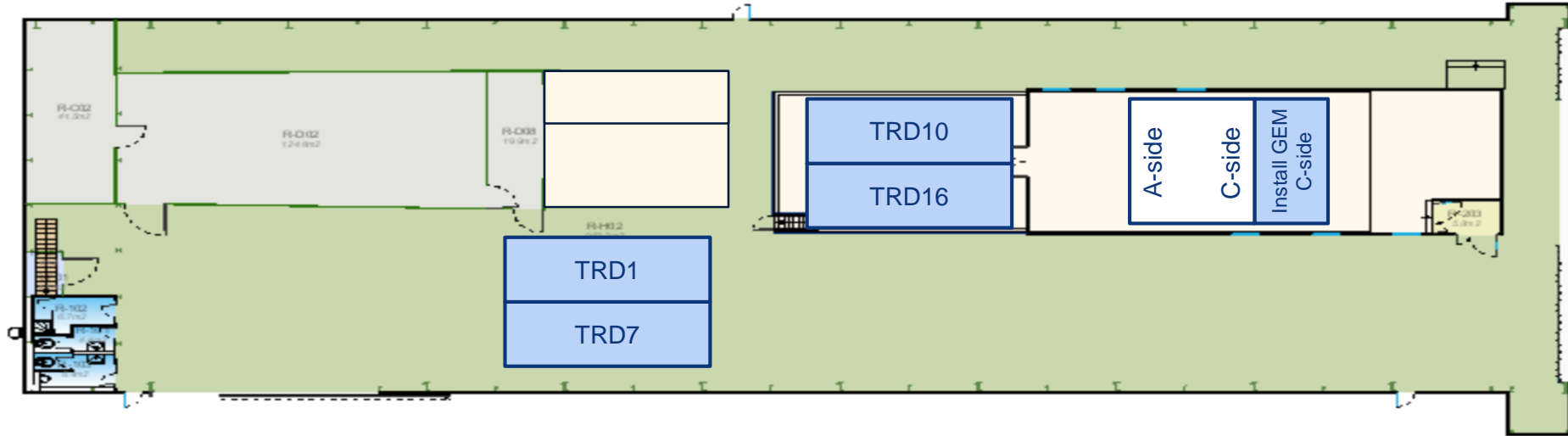

# SXL2 activities w36 – Fri 6 Sep 2019

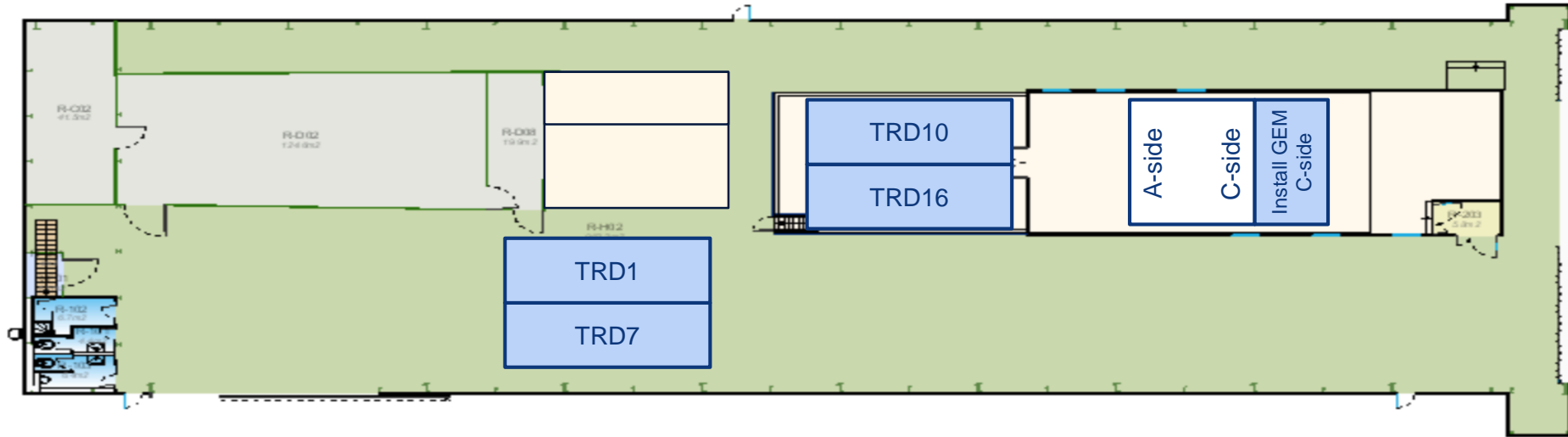



# Miniframe activities w36 – Mon 2 Sep 2019

ITS-PP2 mockup  
(Fabio, Mimmo)

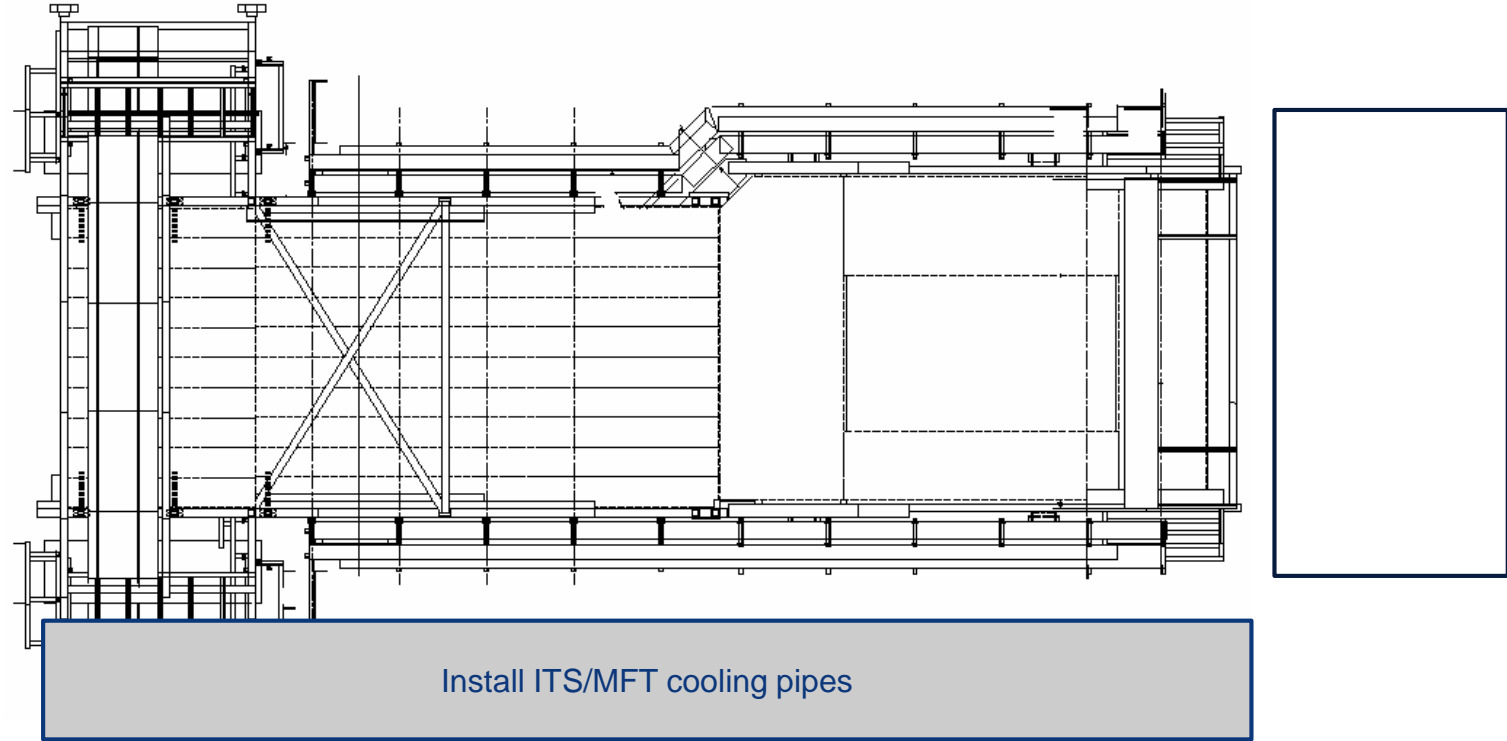

# Miniframe activities w36 – Tue 3 Sep 2019

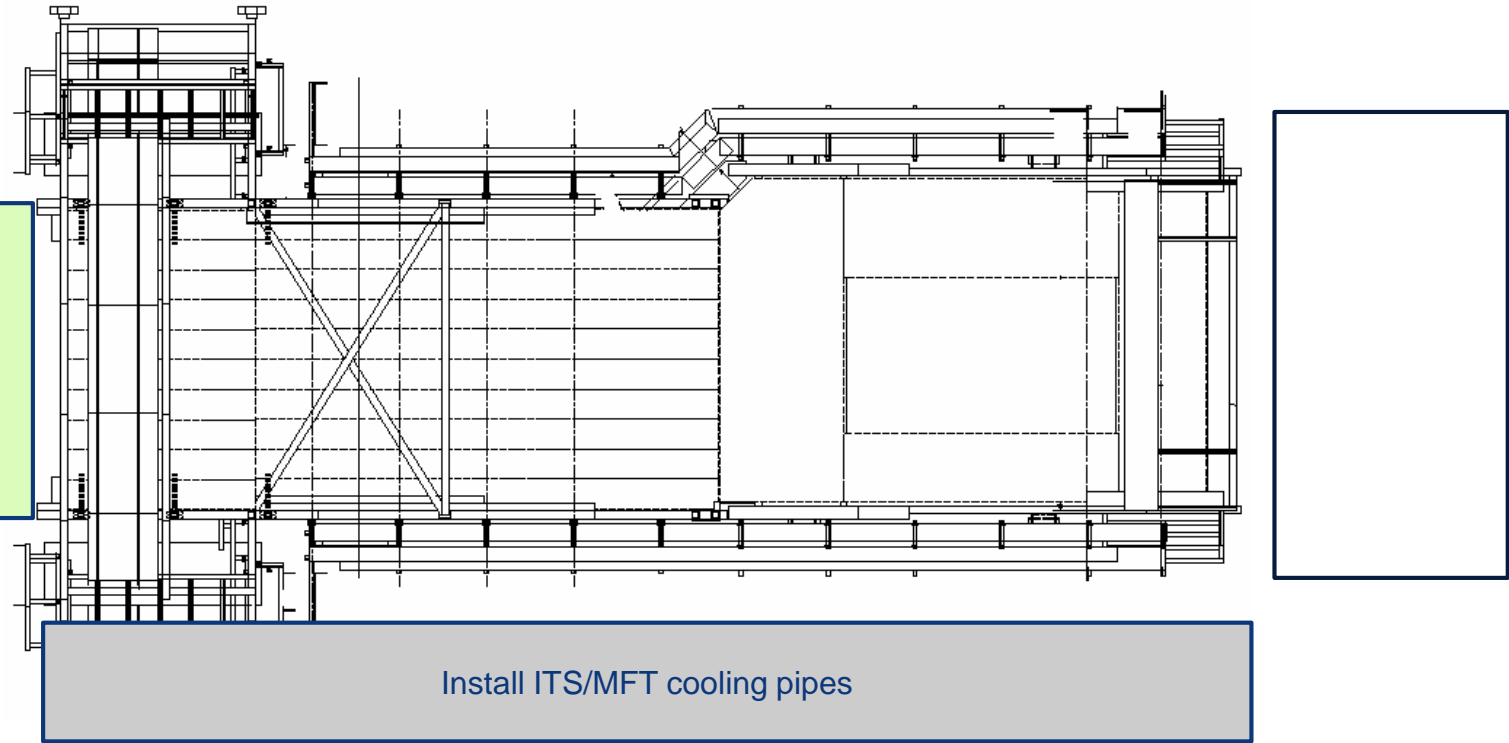

# Miniframe activities w36 – Wed 4 Sep 2019

P test multilayer pipes

Install ITS/MFT  
PP1-PP2 mockup-  
cables (Evgeny)

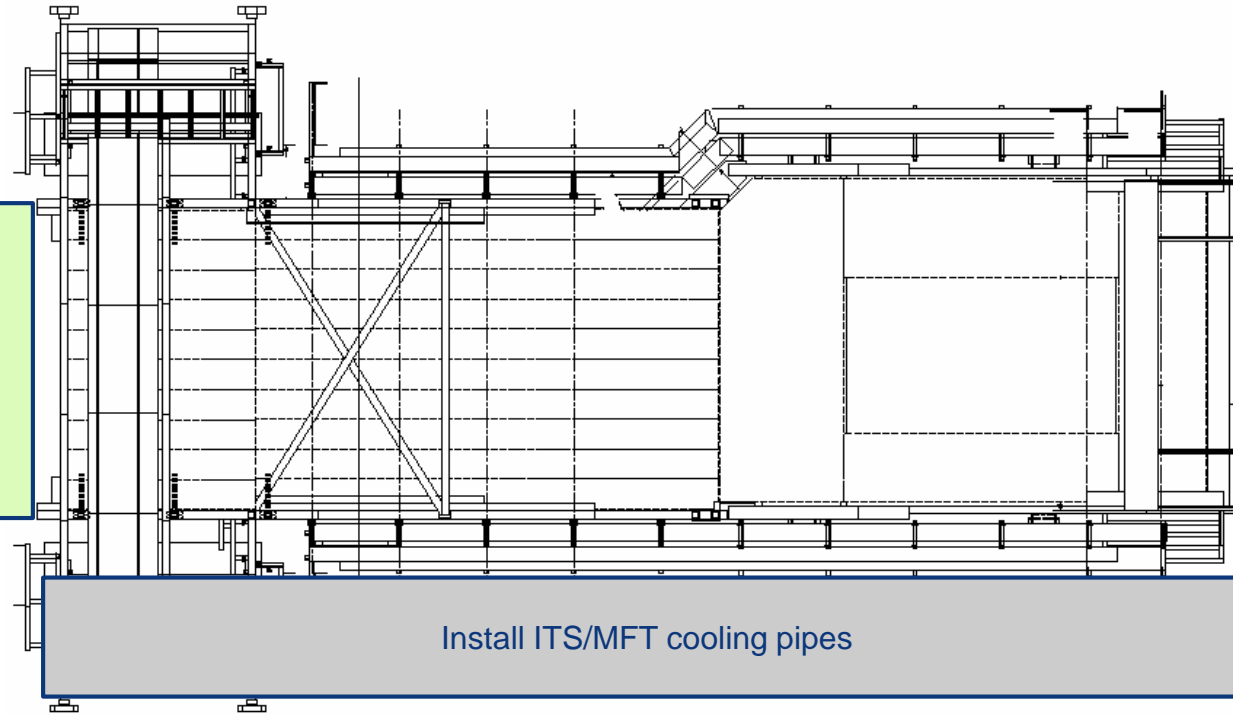

# Miniframe activities w36 – Thu 5 Sep 2019

CERN official holiday (Jeune Genevois)

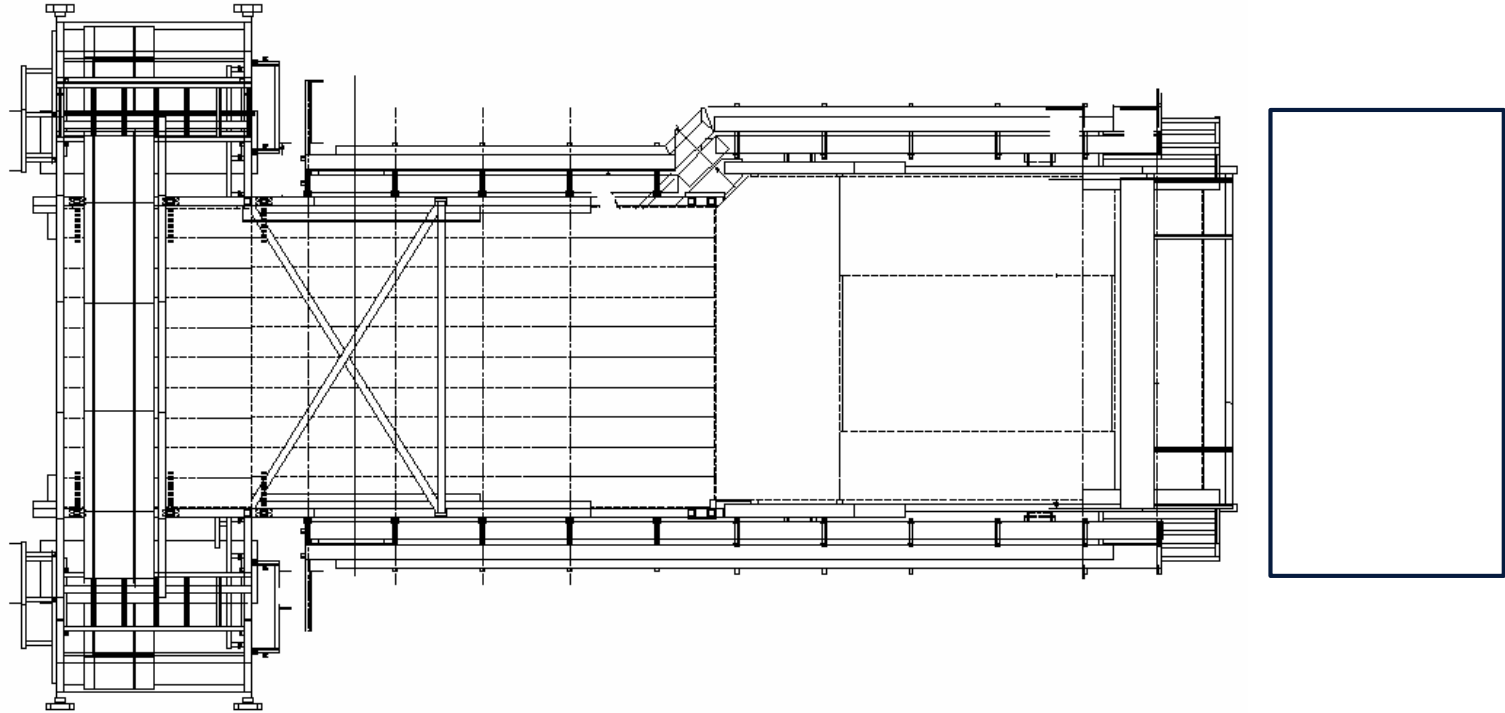

# Miniframe activities w36 – Fri 6 Sep 2019

P test multilayer pipes

Install ITS/MFT  
PP1-PP2 mockup-  
cables (Evgeny)

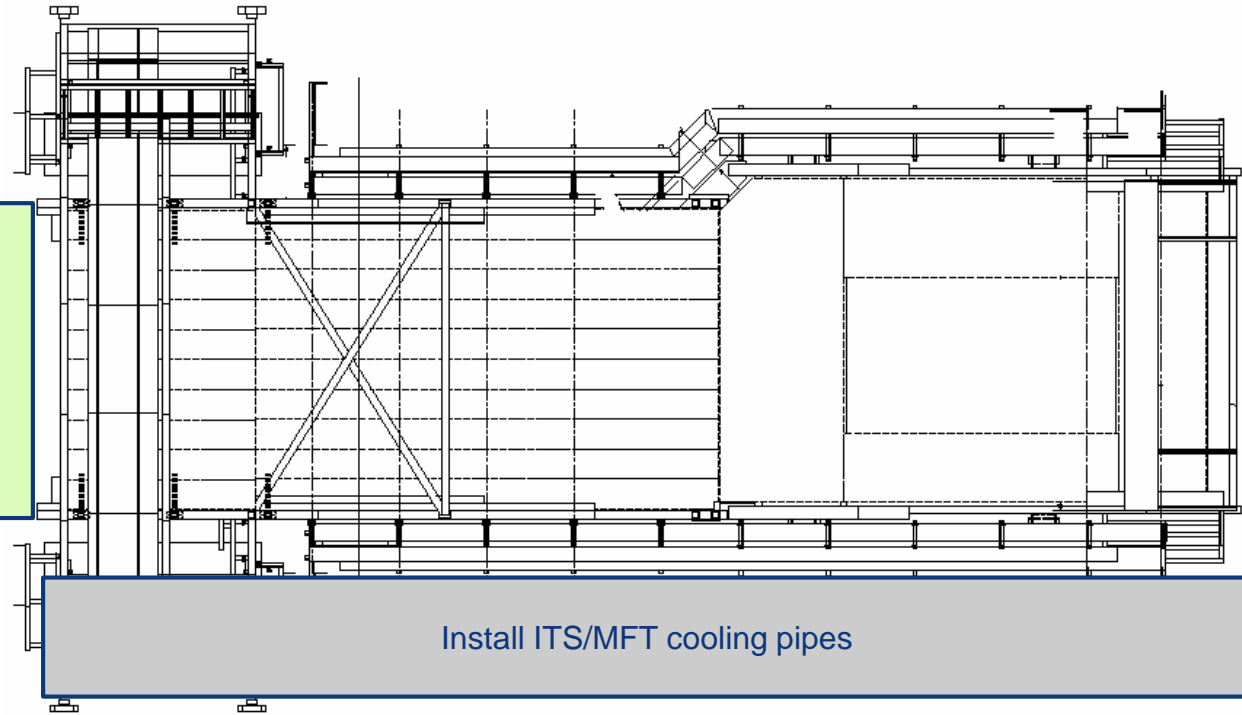

# Day-by-day sequence w37



# UX25 activities w37 – Mon 9 Sep 2019

CR0: water spray test IT3-4 (EN-CV)

ALTEAD: move one L3 transformer to SXL2 dalle

OD: installation SX2 and group forming tents

Remove CR3 cables

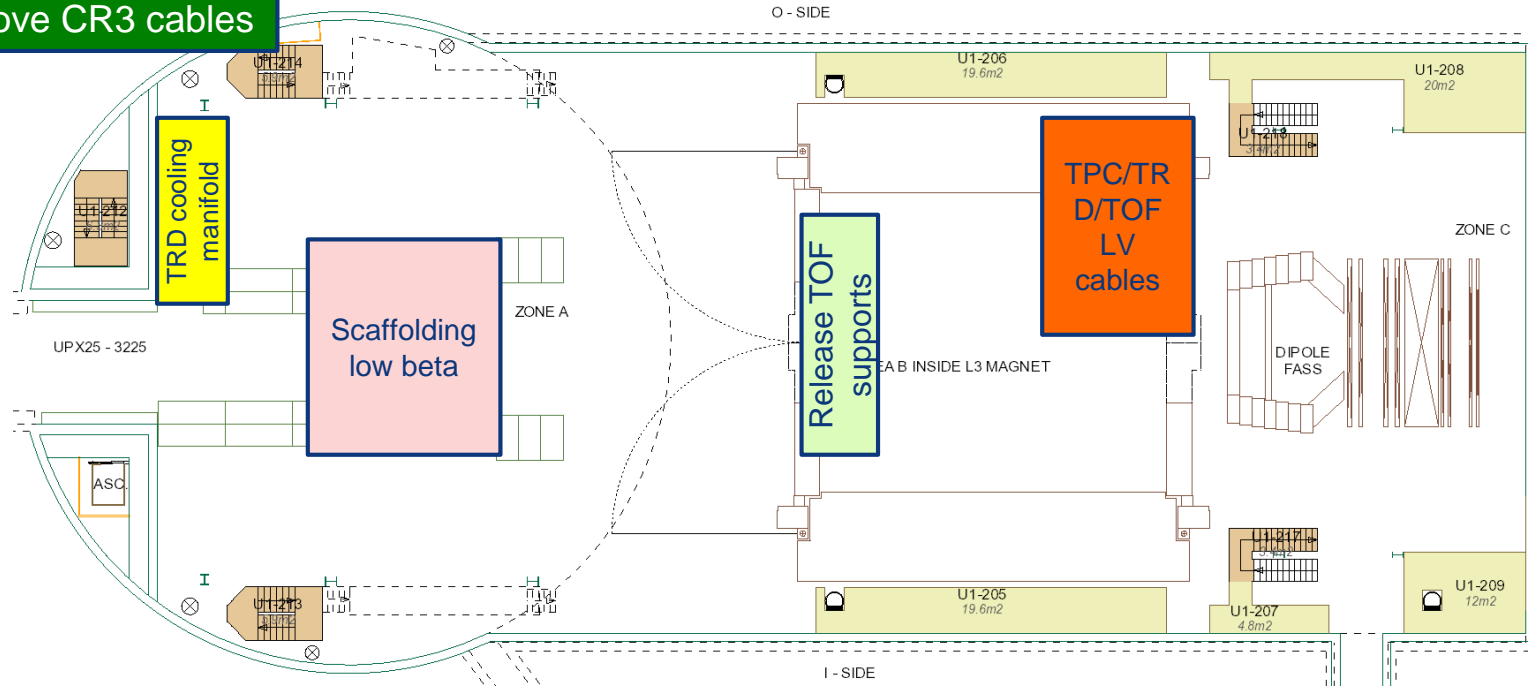

# UX25 activities w37 – Tue 10 Sep 2019

CR0: air leak test test IT3-4 (Exenco) + aerial photo (need nacelle)

OD scaffolding safety reception (PM)

ALTEAD: bring pallet to CR3

Remove CR3 cables

ALTEAD: bring DCal SM to SX2

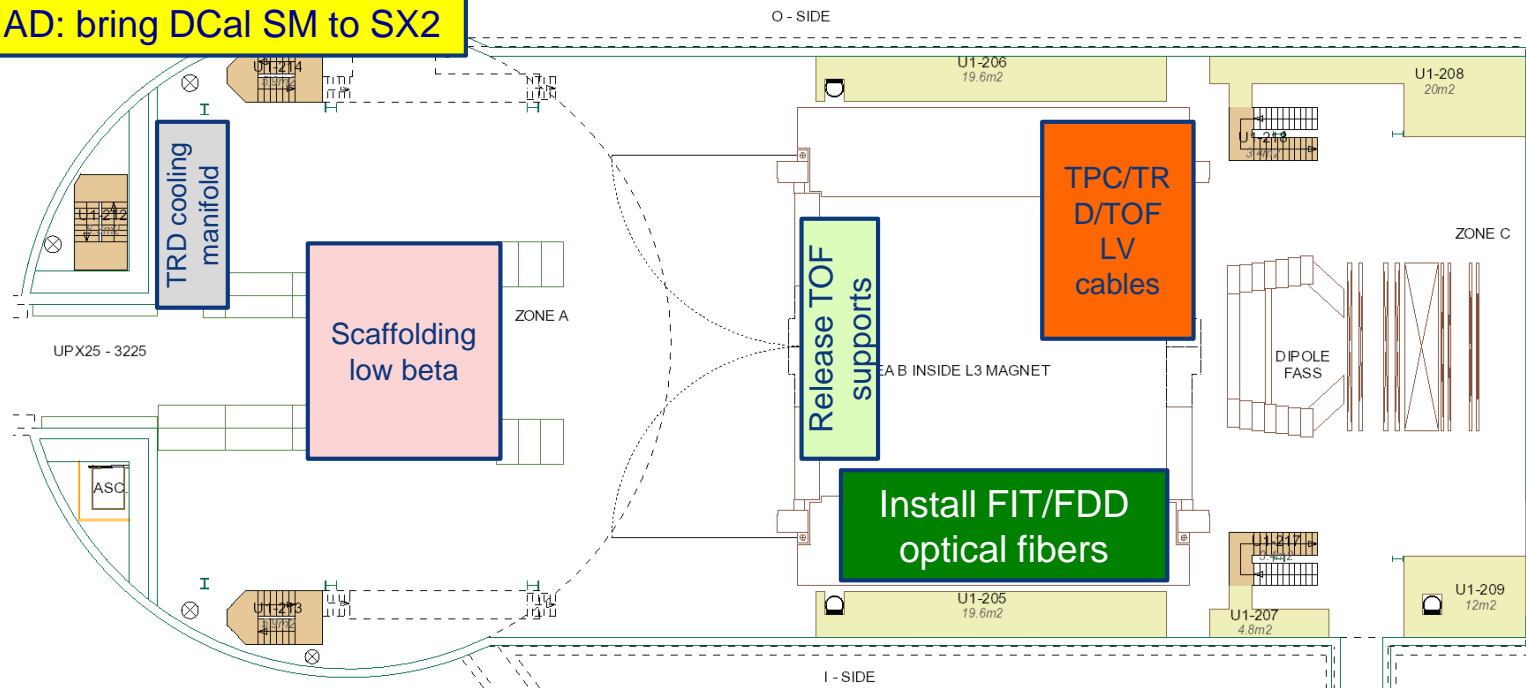



# UX25 activities w37 – Wed 11 Sep 2019

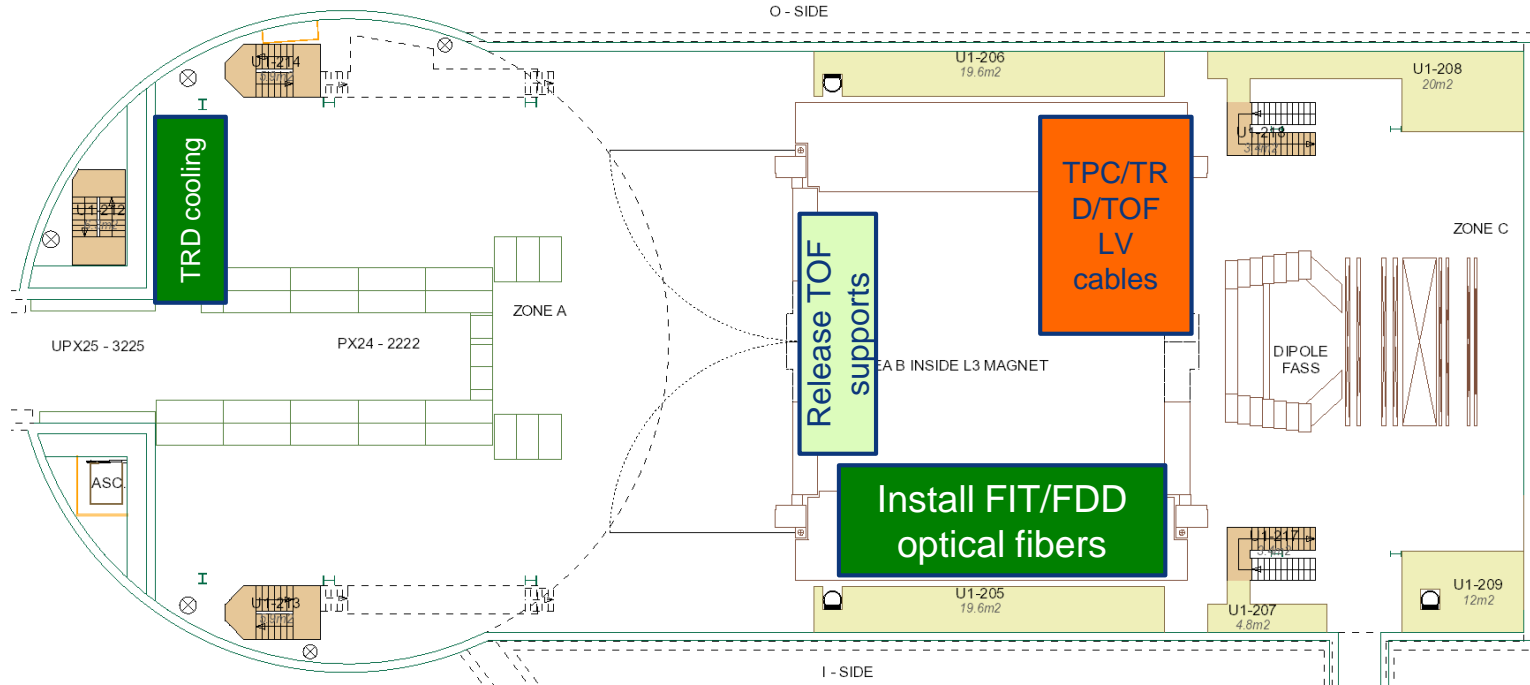

# UX25 activities w37 – Thu 12 Sep 2019

Install SX2 poster (Remarq) – need nacelle

ALTEAD: bring TRD SM to SX2

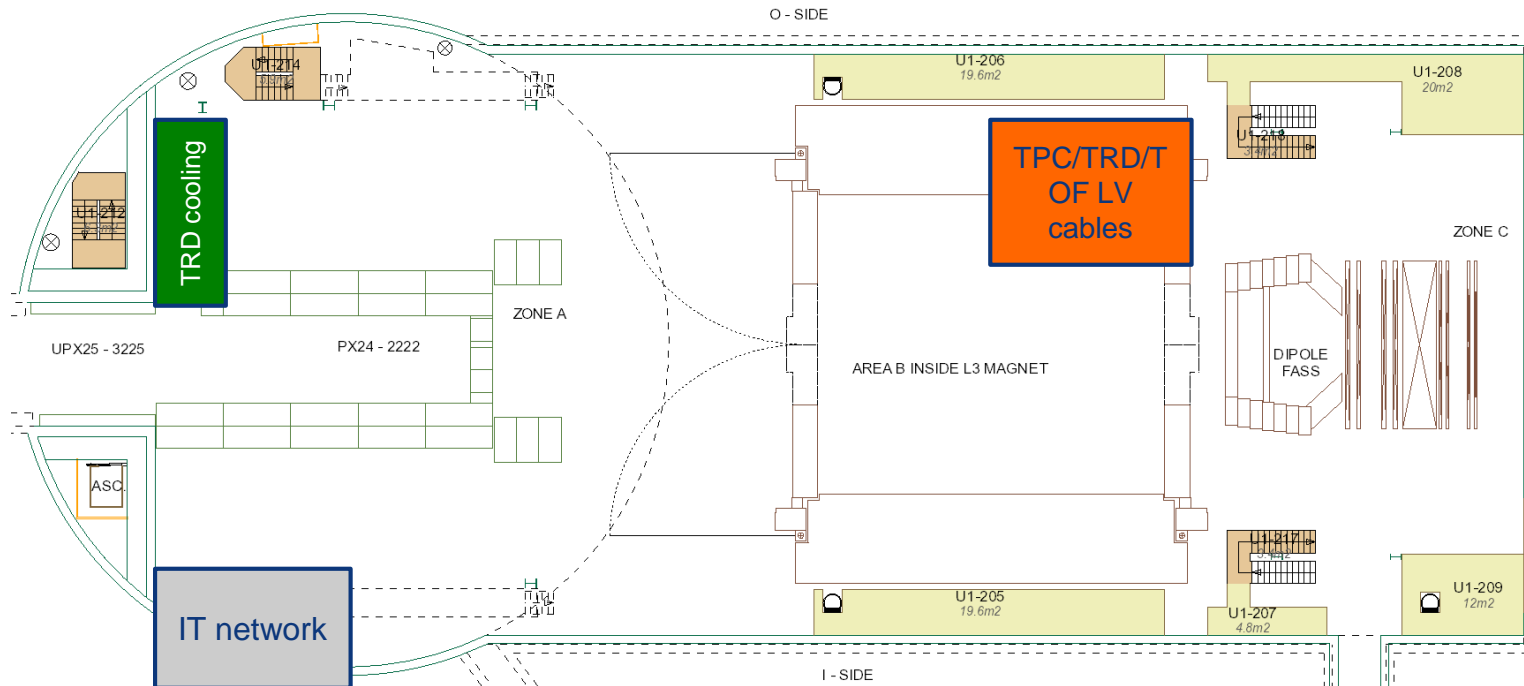

# UX25 activities w37 – Fri 13 Sep 2019

OD preparation (SX2) + CERNois visit

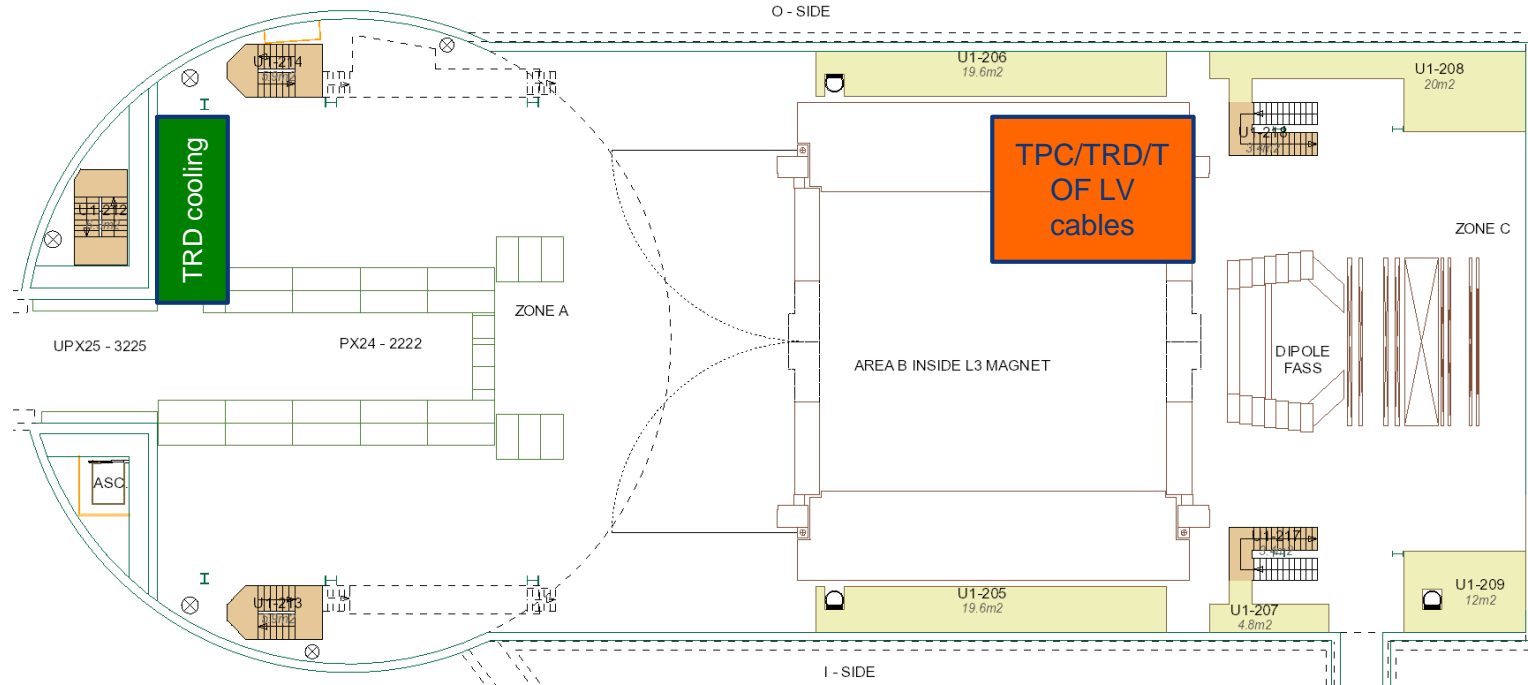

# SXL2 activities w37 – Mon 9 Sep 2019

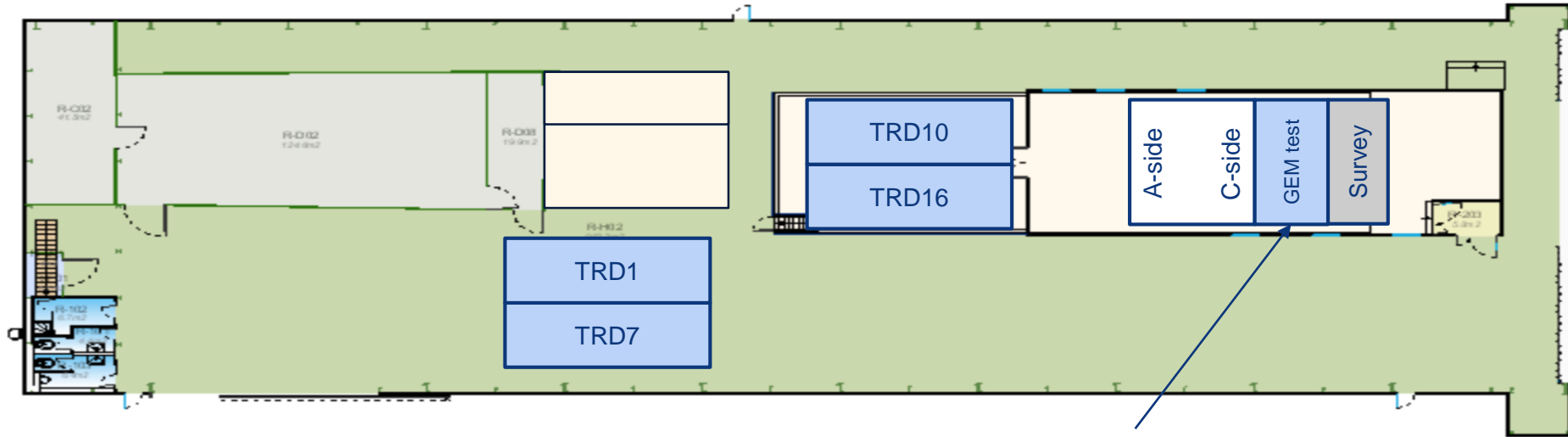

Fill TPC with dry air and test GEMs (leakage current test)  
+  
FC powering test with Air and GEMs grounded

# SXL2 activities w37 – Tue 10 Sep 2019

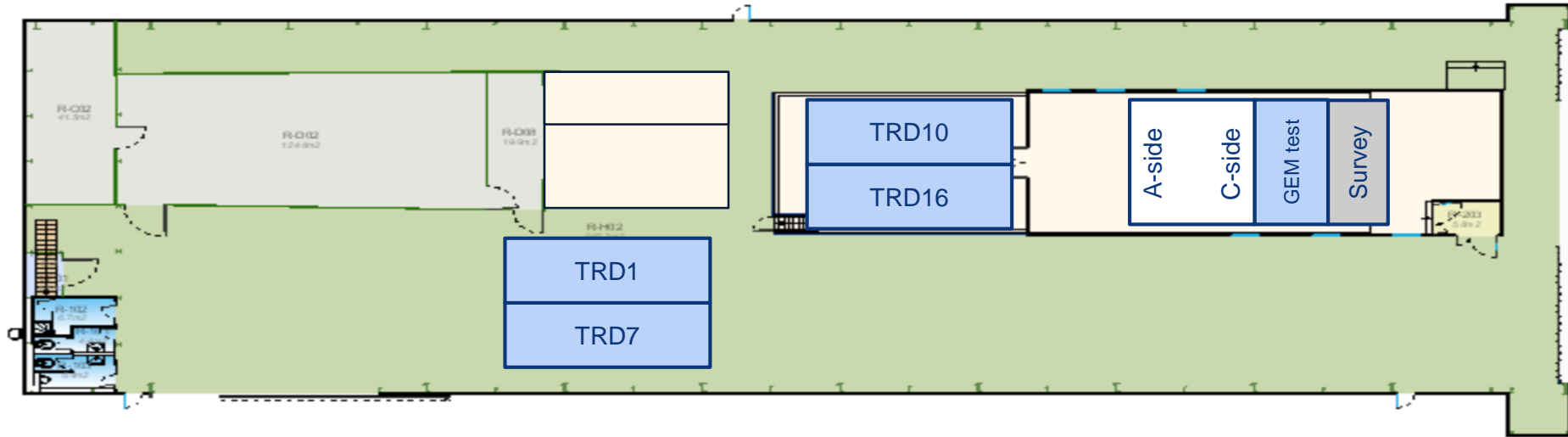

# SXL2 activities w37 – Wed 11 Sep 2019

ALTEAD: bring DCal and TRD7 in SX2 (for OD)

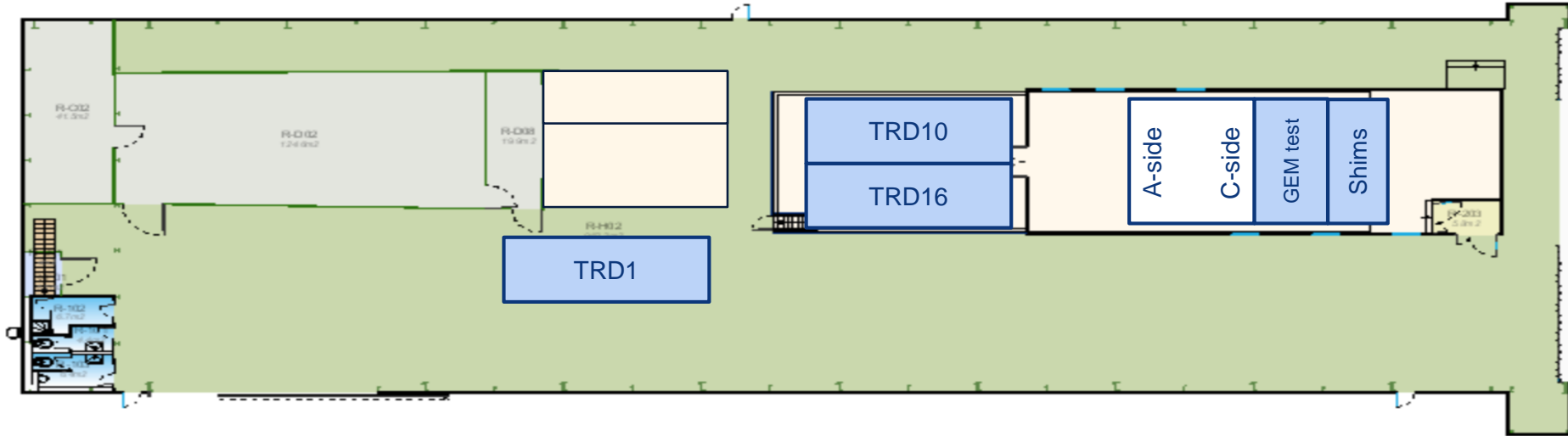

# SXL2 activities w37 – Thu 12 Sep 2019

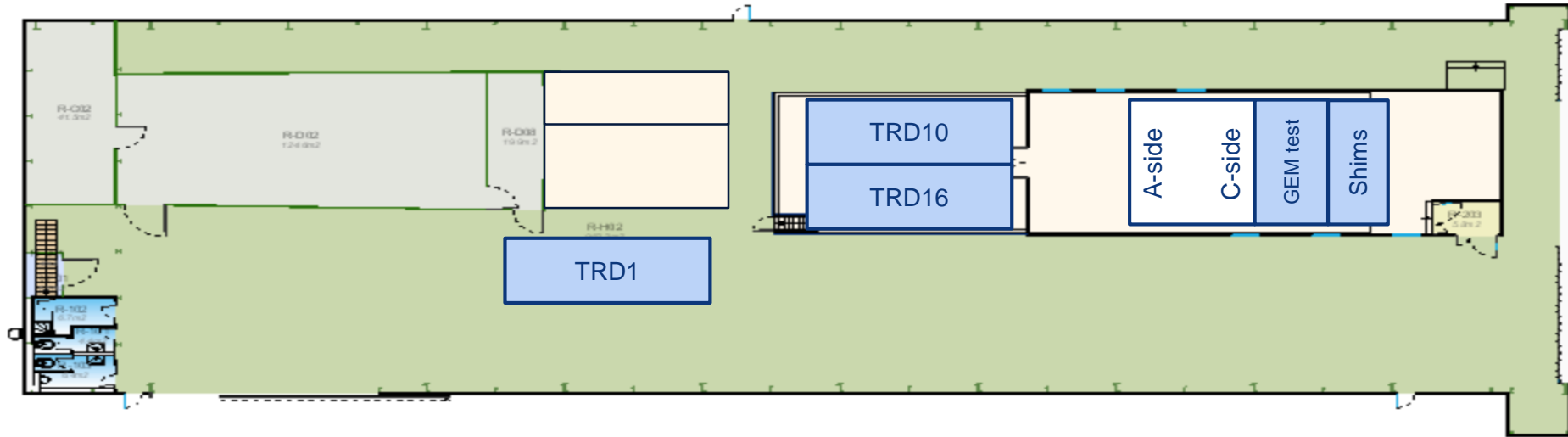

# SXL2 activities w37 – Fri 13 Sep 2019

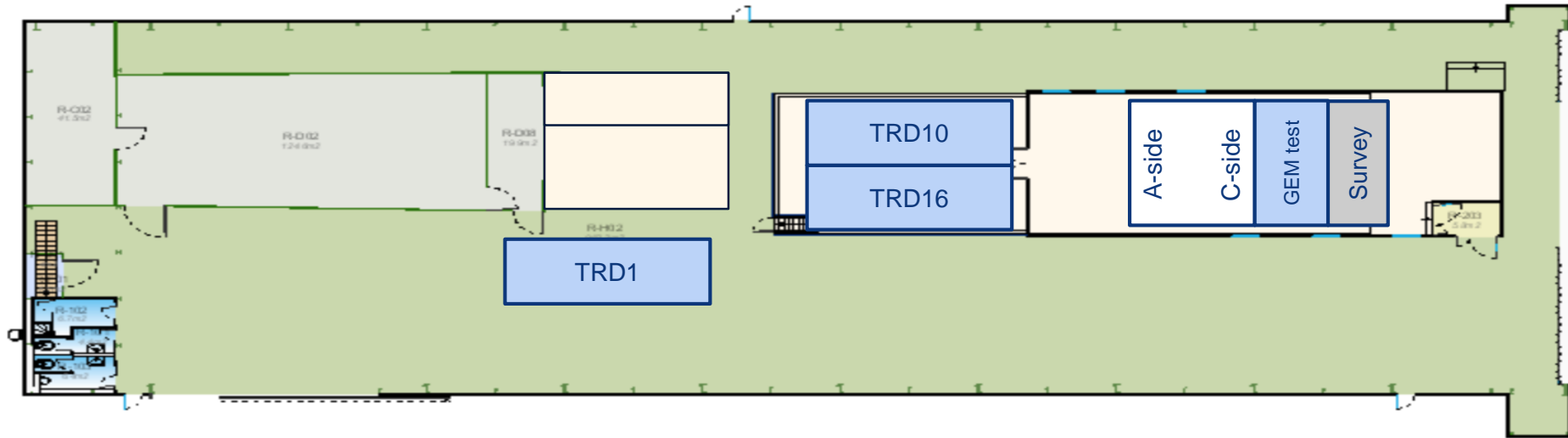



# Miniframe activities w37 – Mon 9 Sep 2019

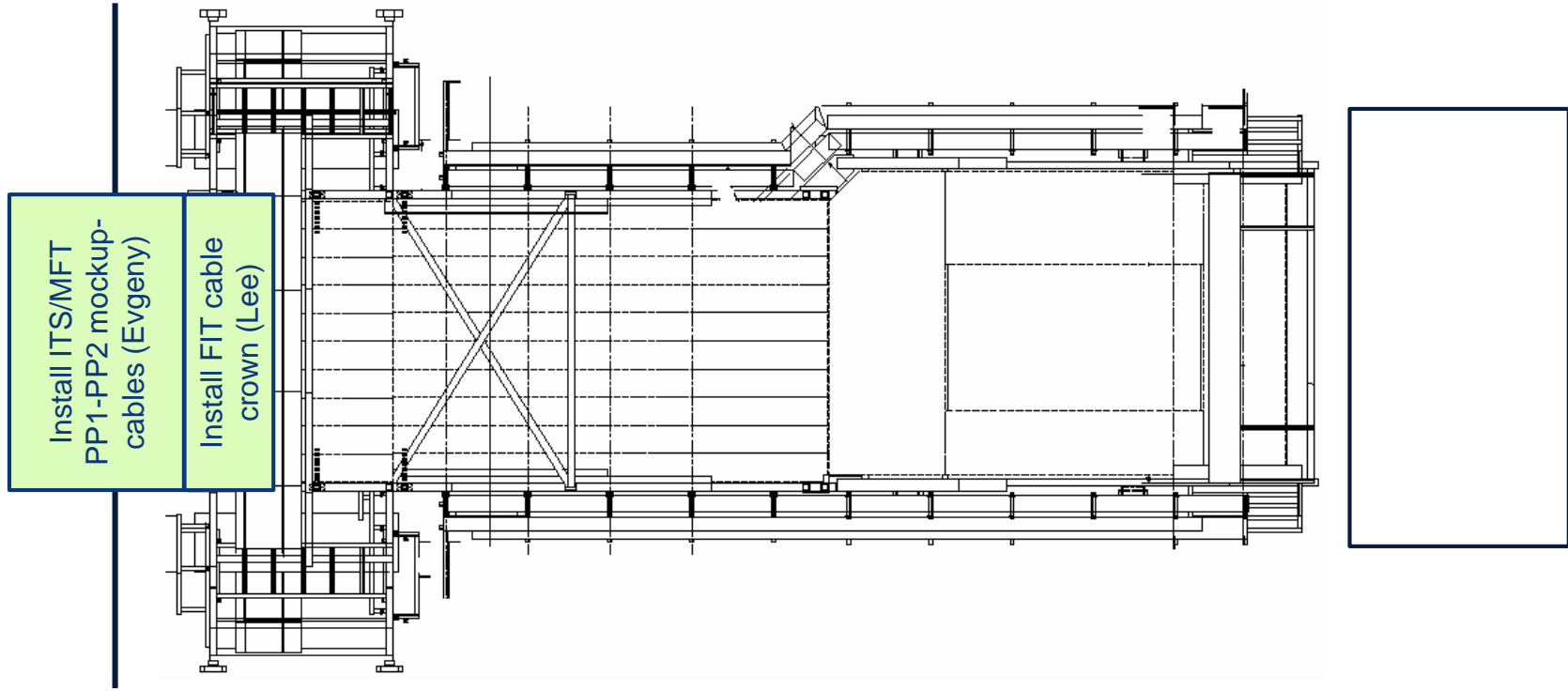

# Miniframe activities w37 – Tue 10 Sep 2019

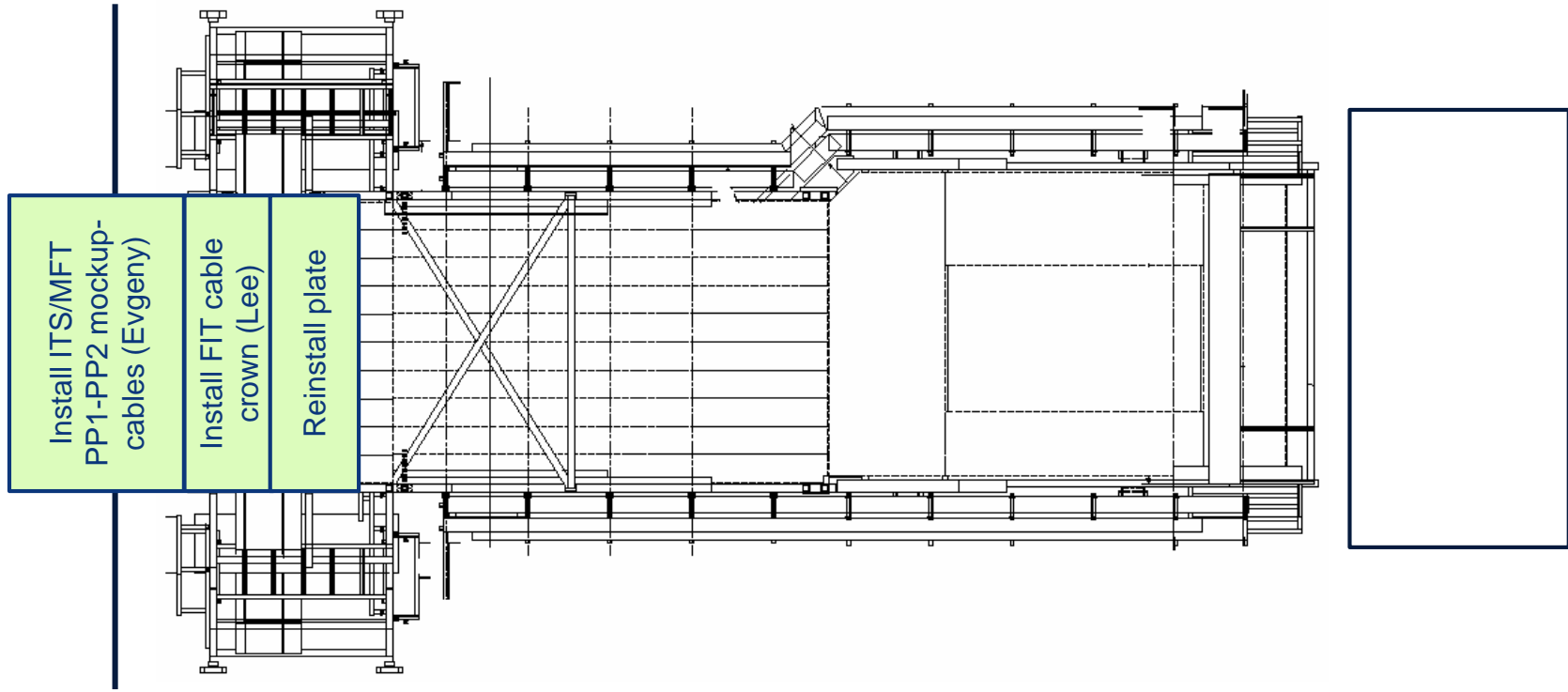

# Miniframe activities w37 – Wed 11 Sep 2019

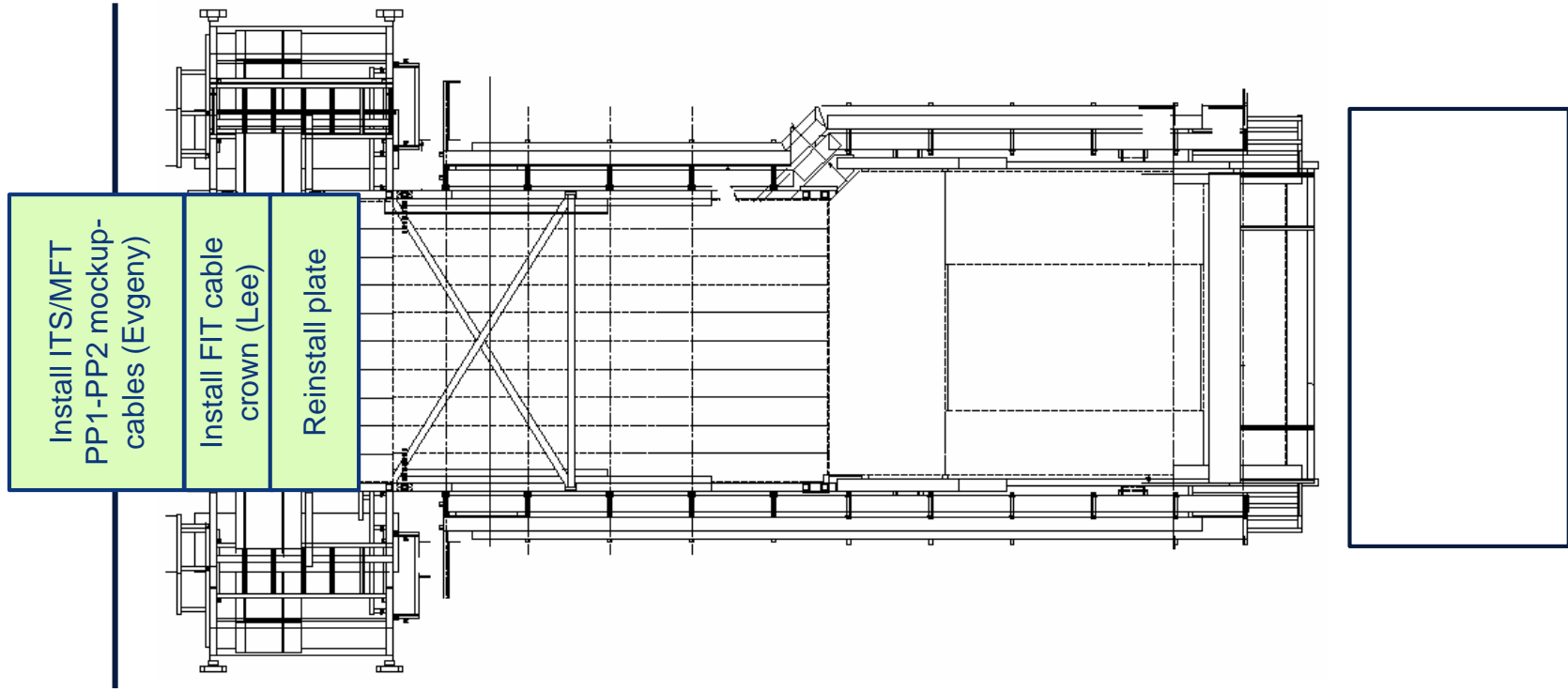

# Miniframe activities w37 – Thu 12 Sep 2019

Displace miniframe barriers (in view of OD)

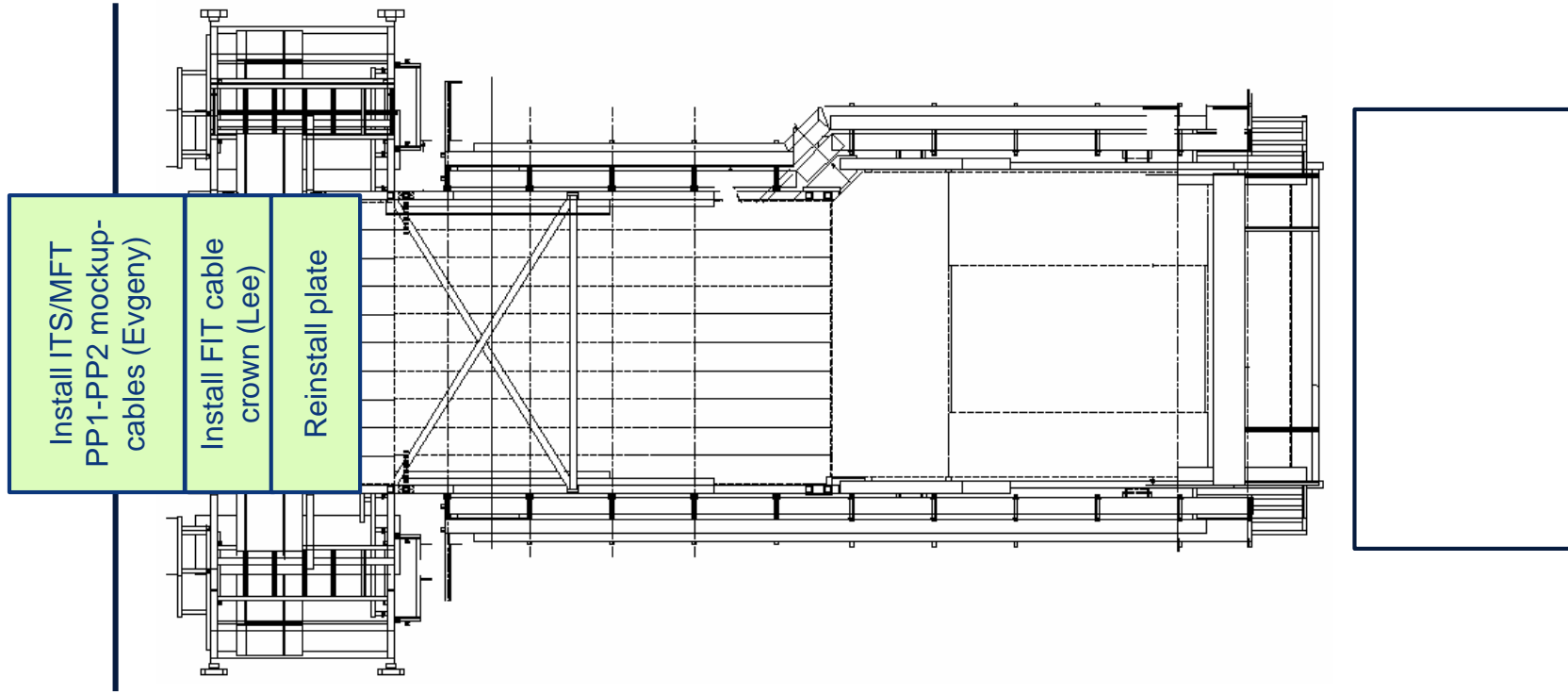

# Miniframe activities w37 – Fri 13 Sep 2019

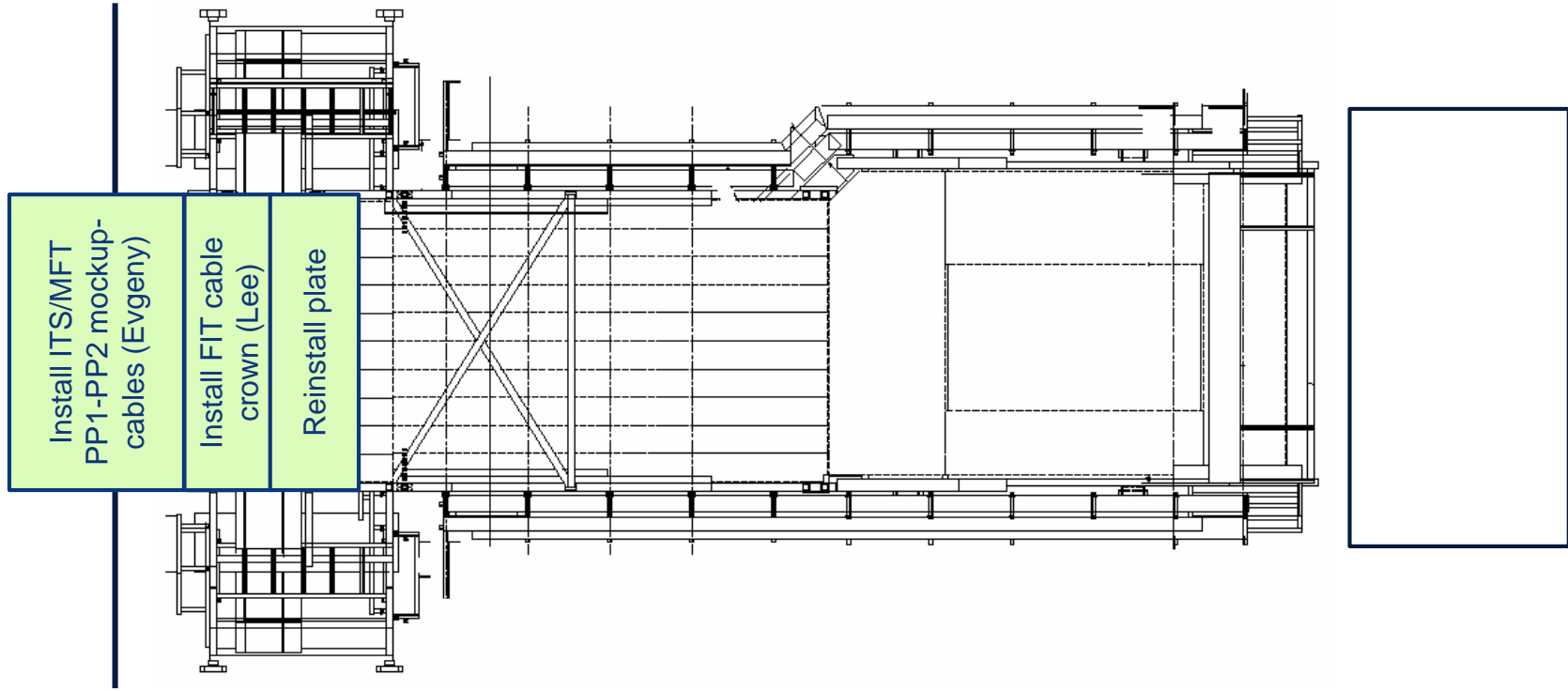

# Day-by-day sequence w38



# UX25 activities w38 – Mon 16 Sep 2019

CR0: install humidifier pipe (ENGIE) – Mon-Wed

CR0: open Roxtecs IT1-2-3 (for ENGIE/Bruno) – Leave IT4 closed!

OD: remove posters, tables etc

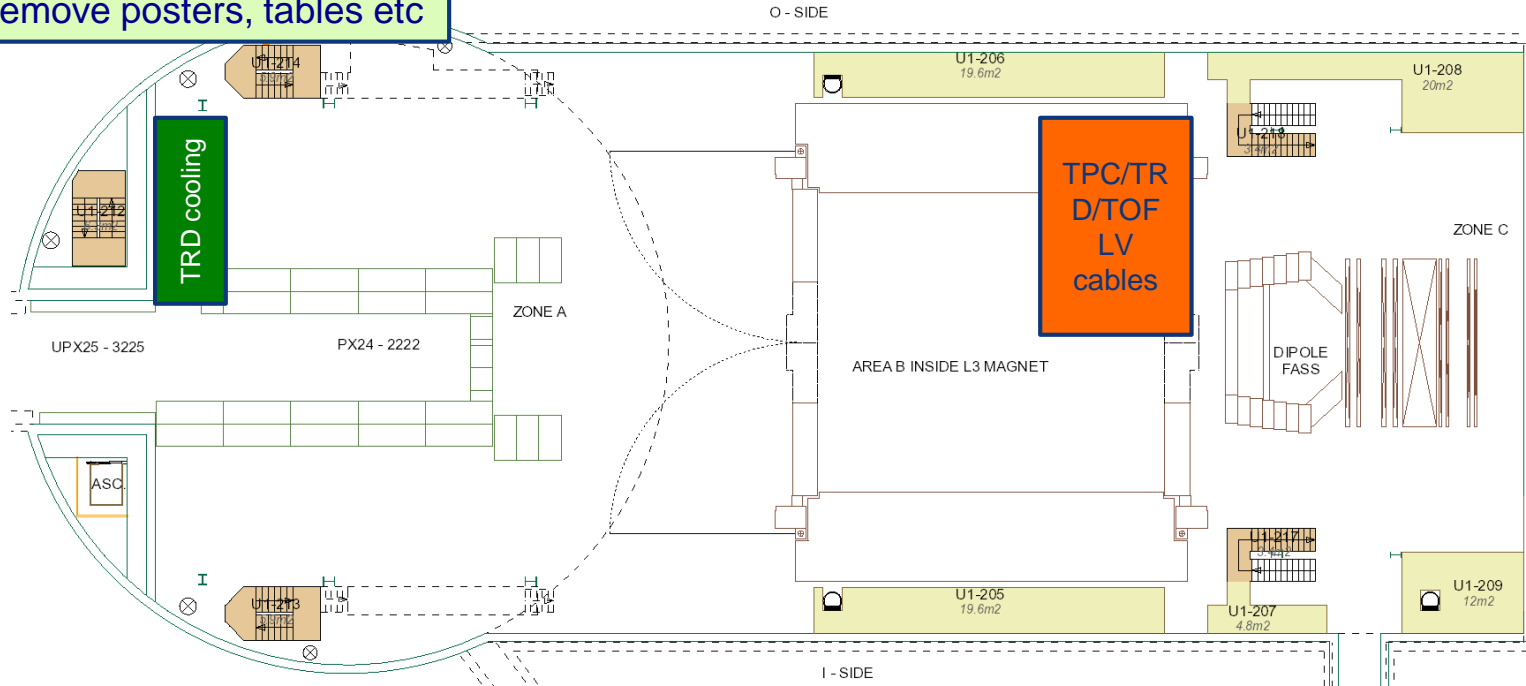

# UX25 activities w38 – Tue 17 Sep 2019

TE-EPC: send L3 transformer to Germany

OD: remove SX2 tent

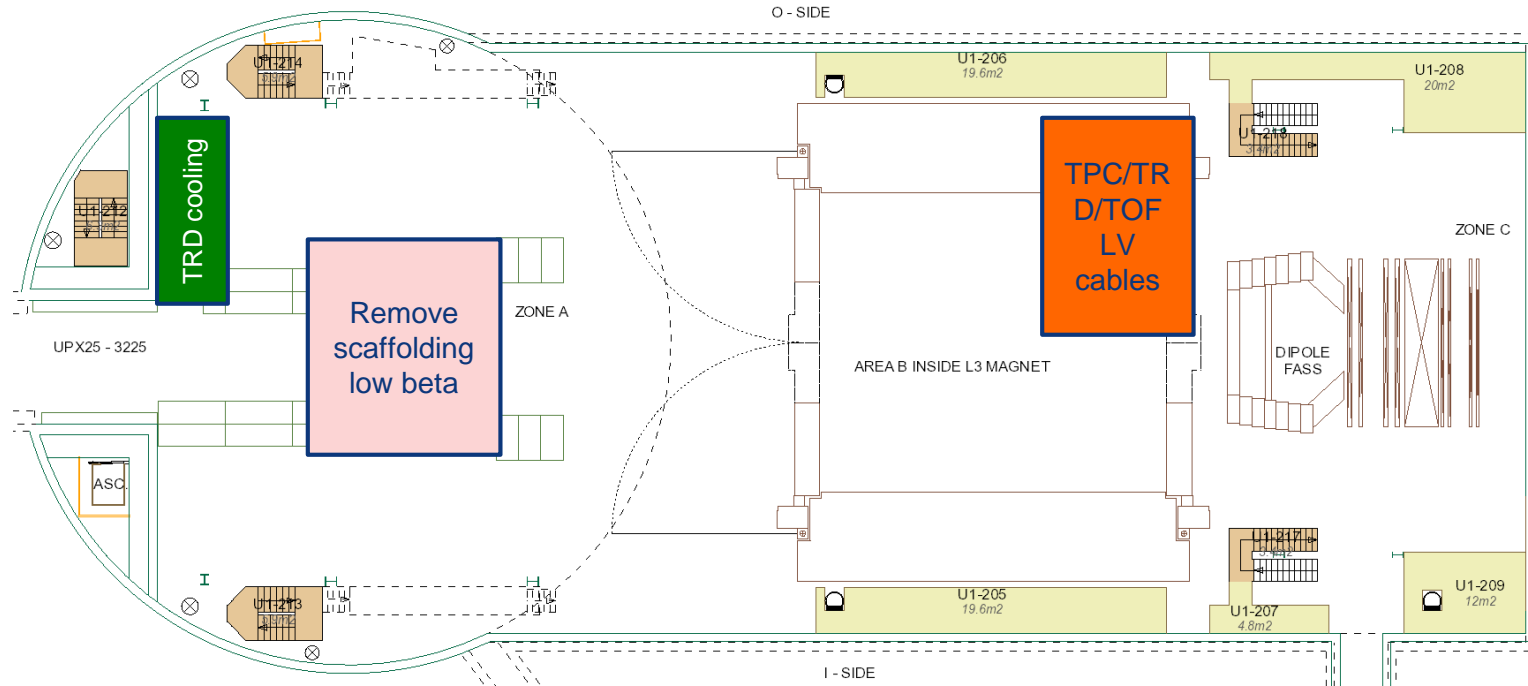



# UX25 activities w38 – Wed 18 Sep 2019

ALTEAD: bring low-beta blocks into SX2

ALTEAD: bring DCal back into SU2 (PM)

ALTEAD: help removing CR0 load banks (2 people)

CR0: open Roxtecs IT4 (for ENGIE/Bruno)

VIP visit at 10:00

Photo ALICE (Max Brice)

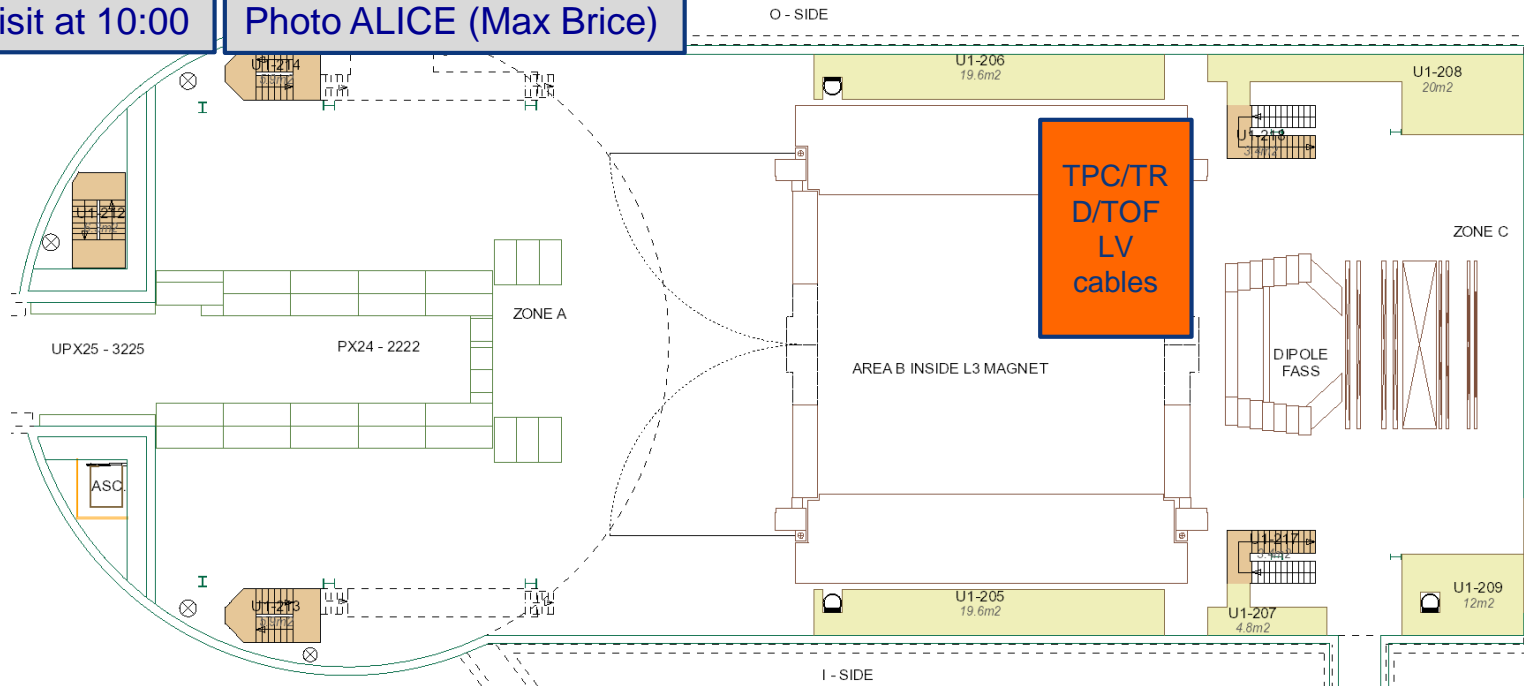

# UX25 activities w38 – Thu 19 Sep 2019

No access to A-side (up to L3 magnet) due to transport of blocks. No visits before 18:00

VIP visit at 12:30

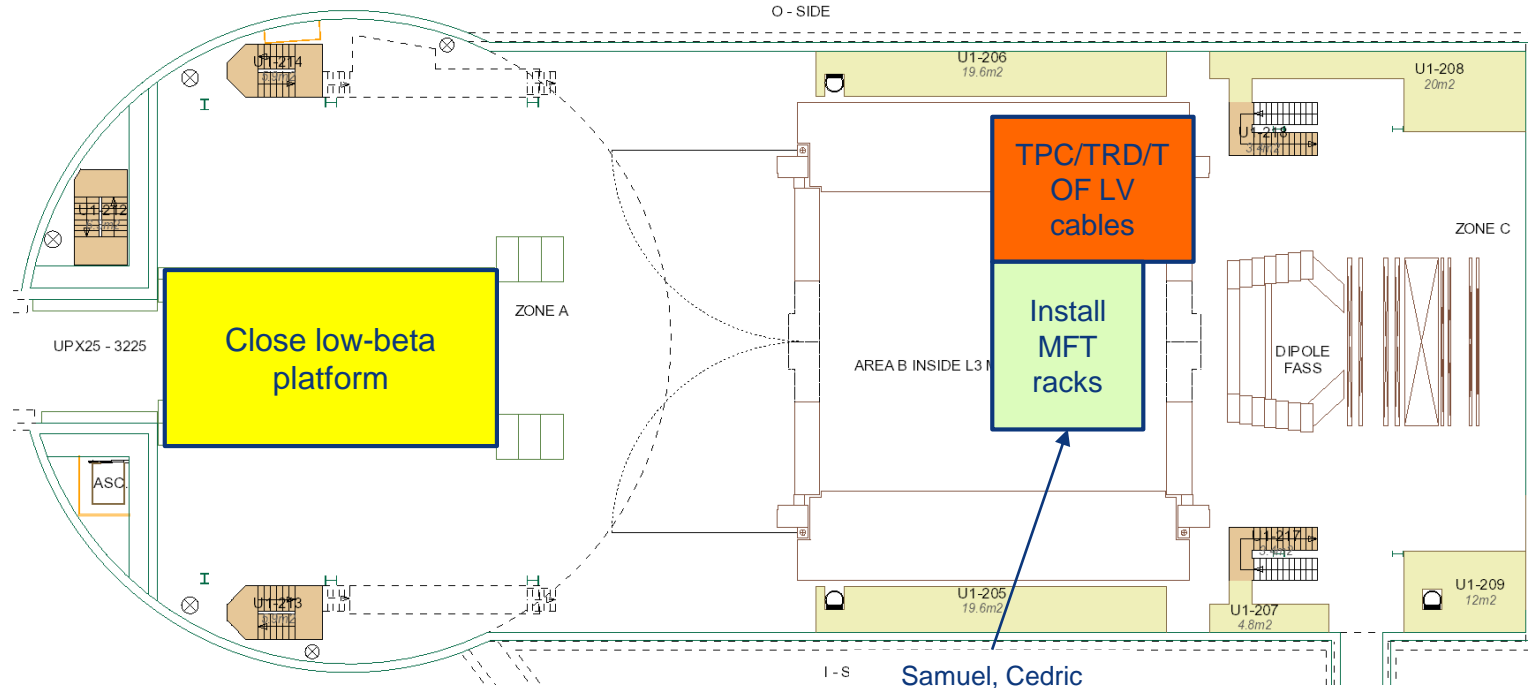

# UX25 activities w38 – Fri 20 Sep 2019

No access to A-side (up to L3 magnet) due to transport of blocks. No visits before 18:00

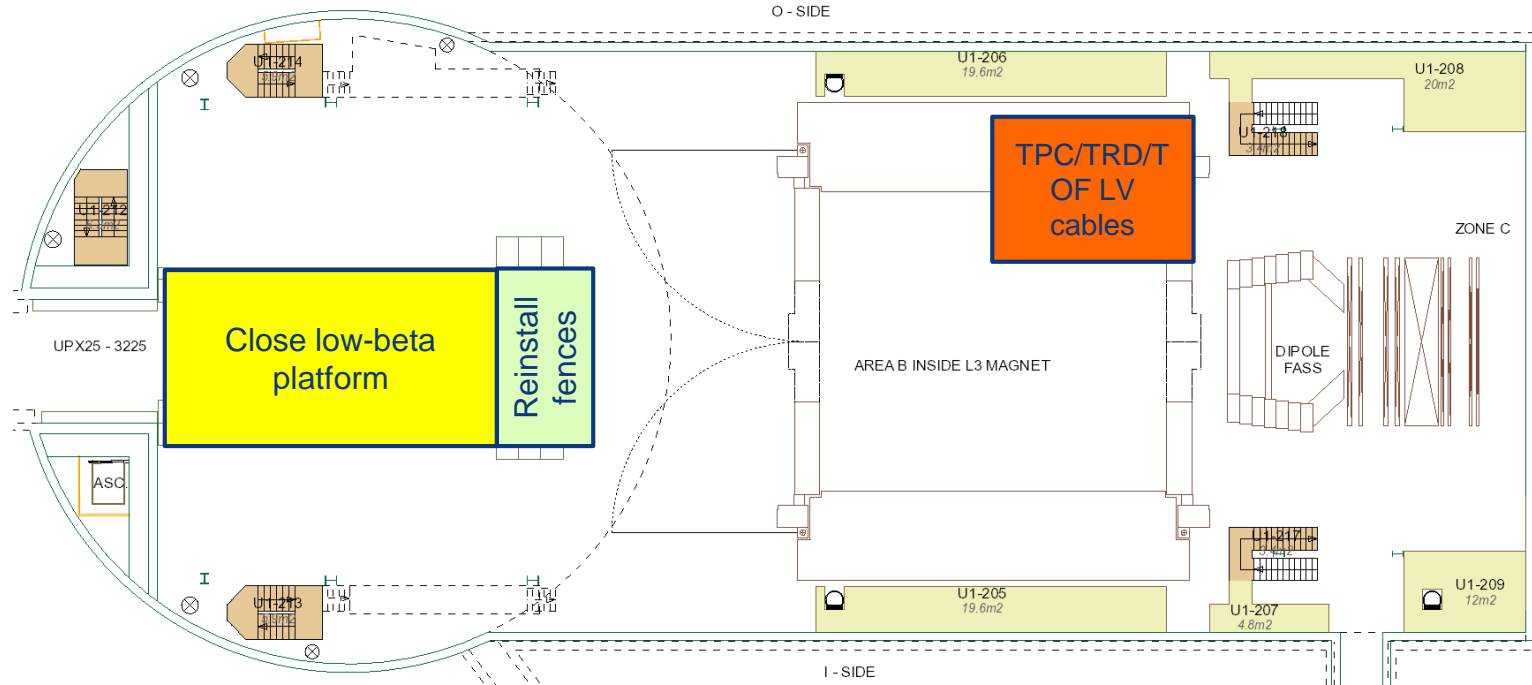

# SXL2 activities w38 – Mon 16 Sep 2019

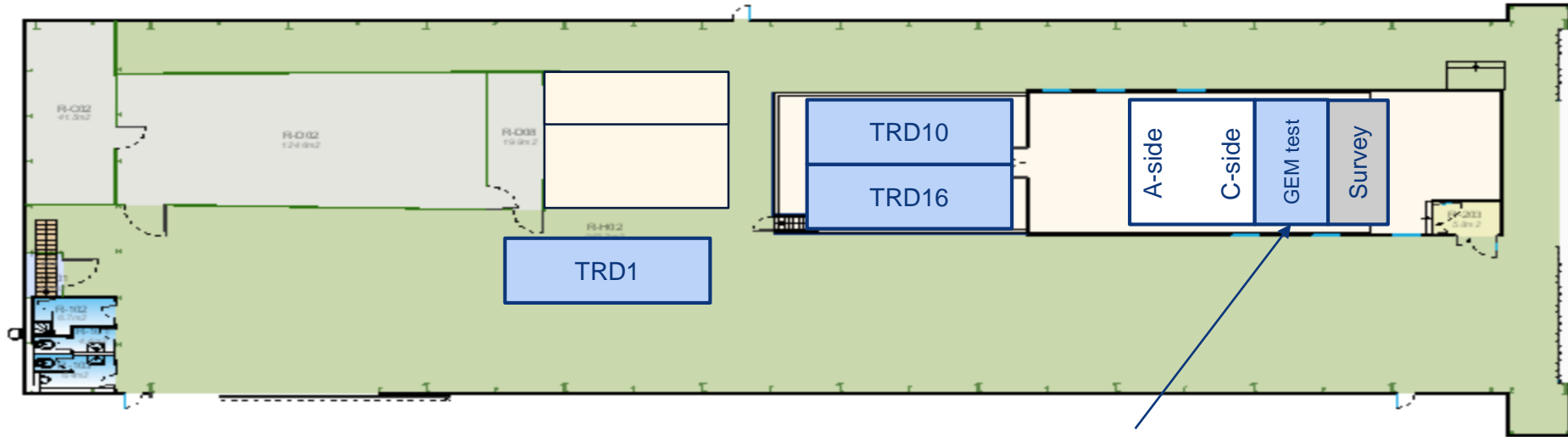

Fill TPC with dry air and test GEMs (leakage current test)  
+  
FC powering test with Air and GEMs grounded

# SXL2 activities w38 – Tue 17 Sep 2019

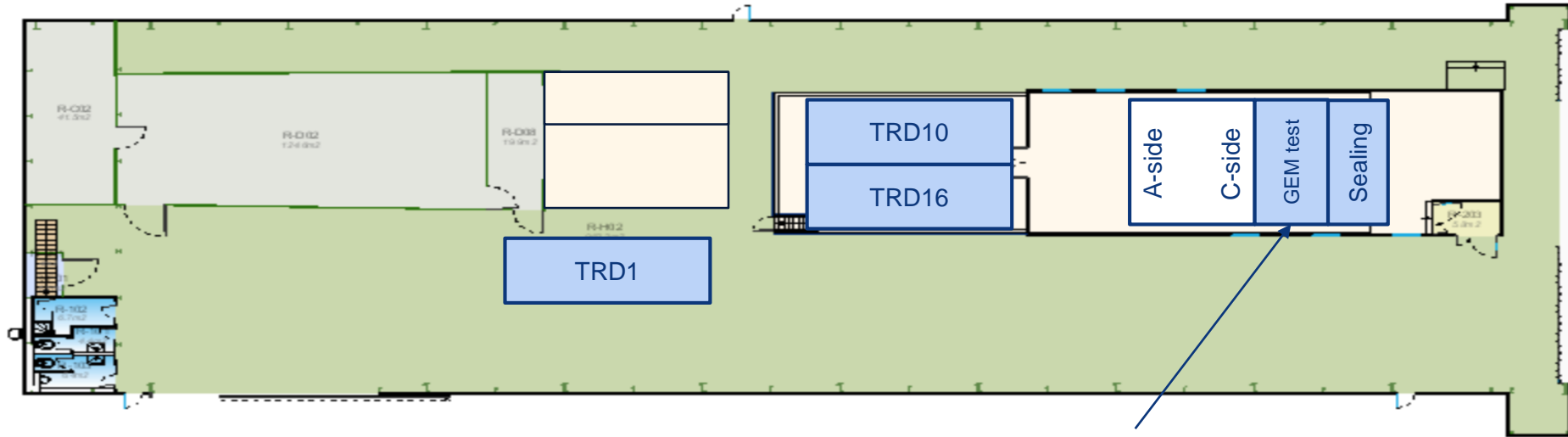

On C side: Reinstall laser prism, splitter and camera boxes.  
Align with laser

# SXL2 activities w38 – Wed 18 Sep 2019

ALTEAD: bring TRD7 back into SXL2

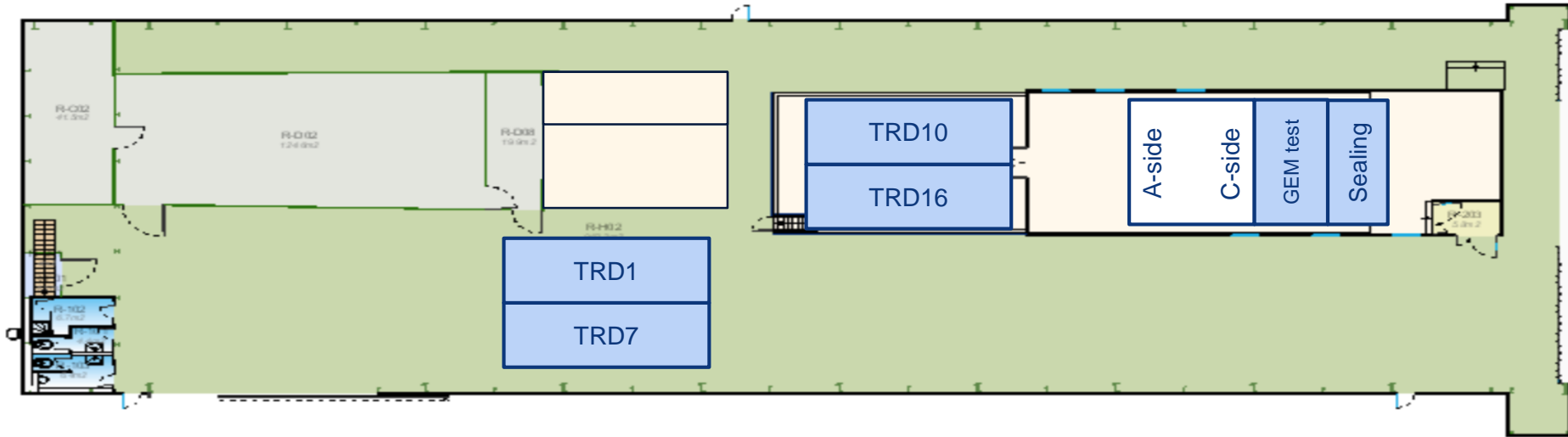

# SXL2 activities w38 – Thu 19 Sep 2019

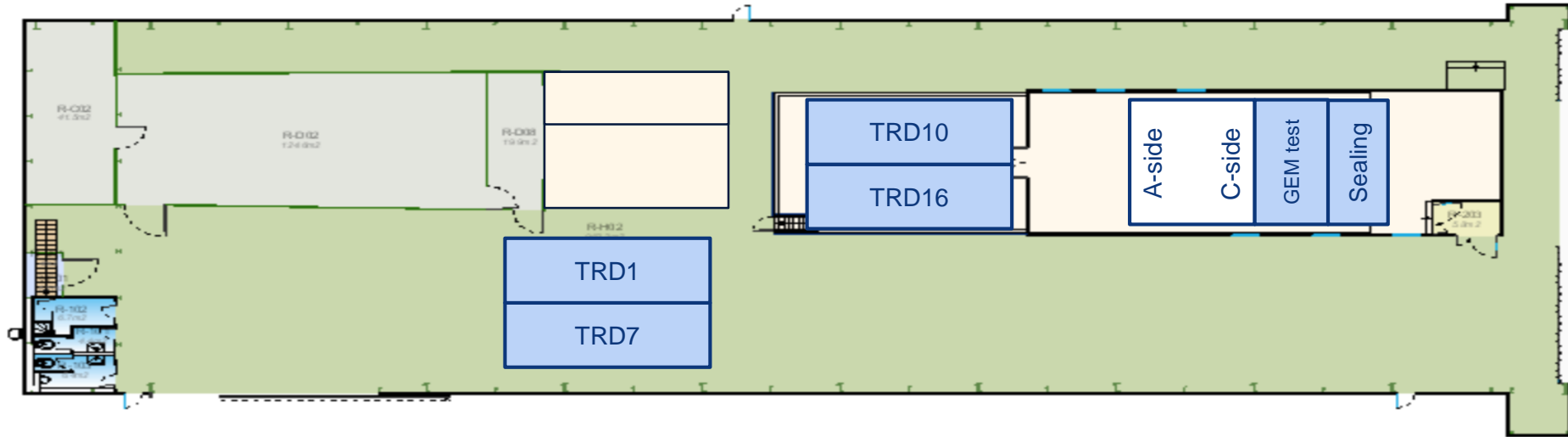

# SXL2 activities w38 – Fri 20 Sep 2019

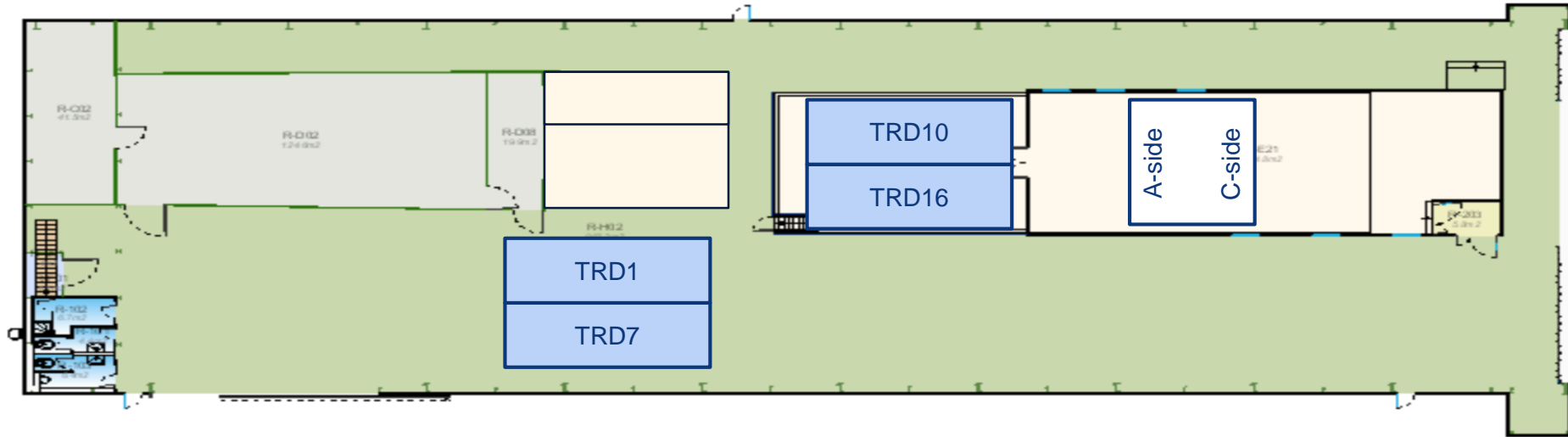



# Miniframe activities w38 – Mon 16 Sep 2019

Pressure test inox pipes (Rampower)

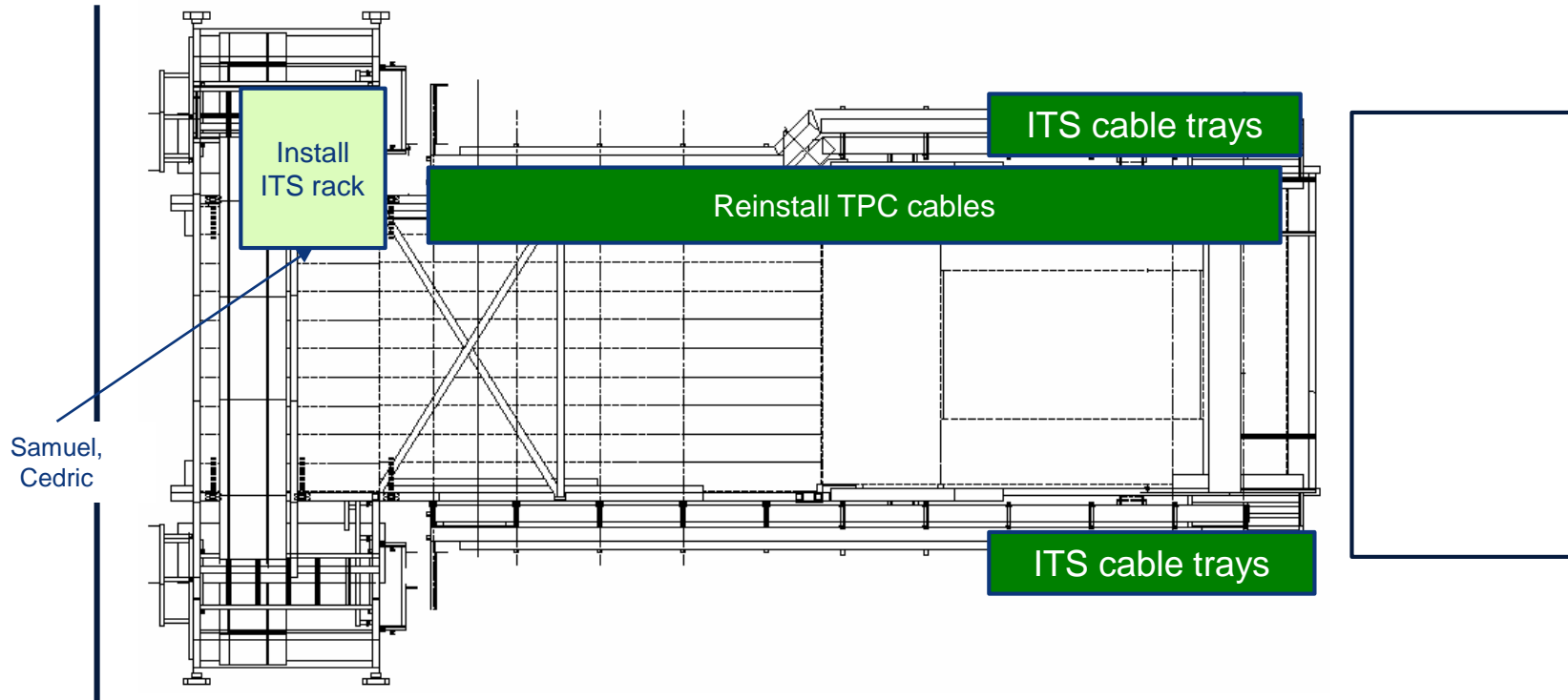

# Miniframe activities w38 – Tue 17 Sep 2019

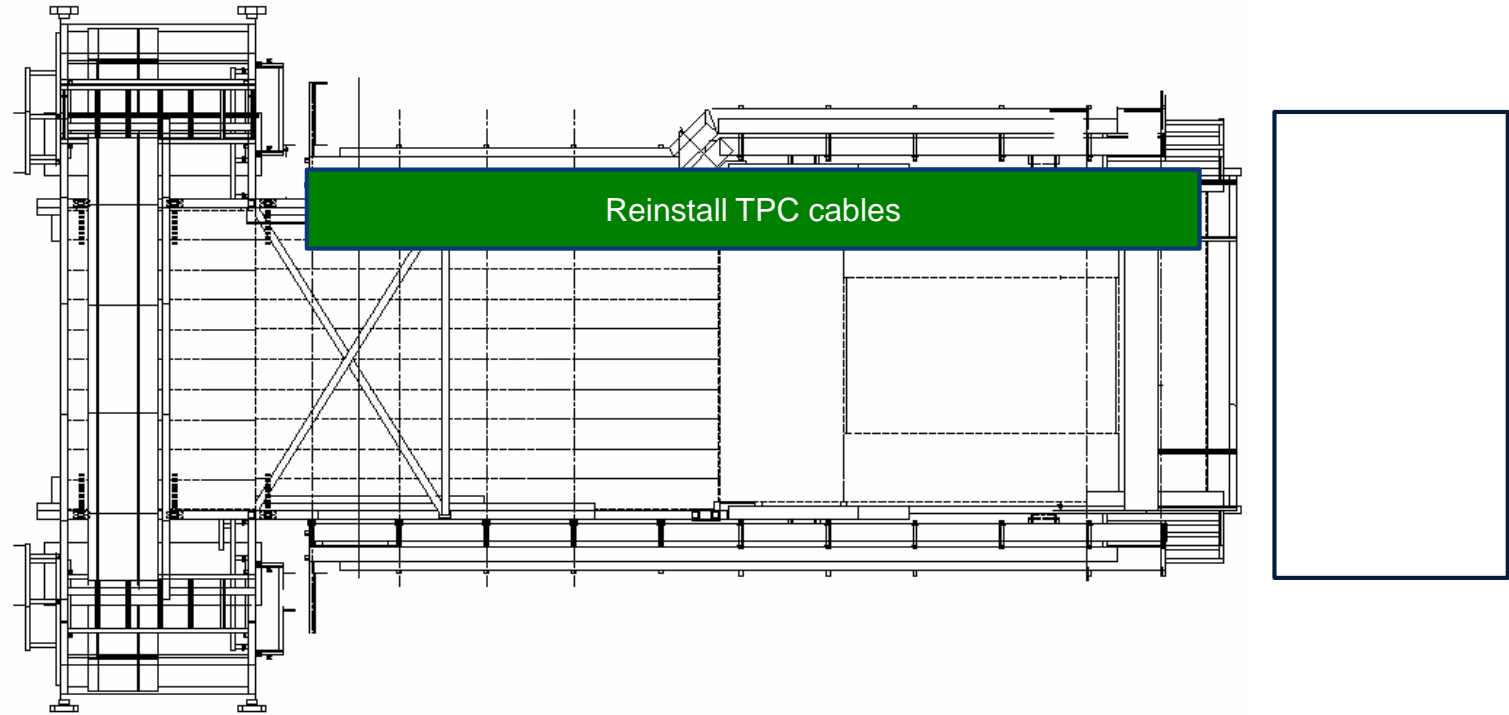

# Miniframe activities w38 – Wed 18 Sep 2019

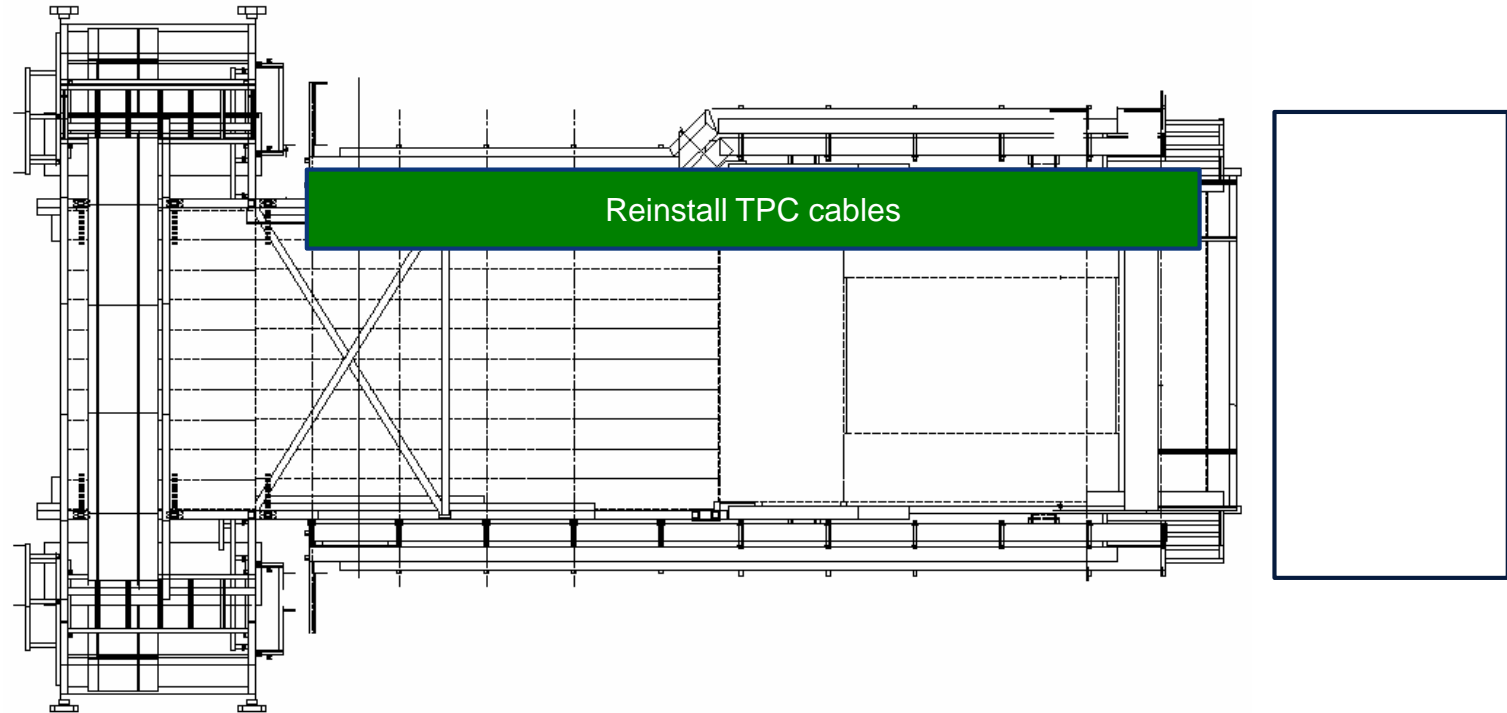

# Miniframe activities w38 – Thu 19 Sep 2019

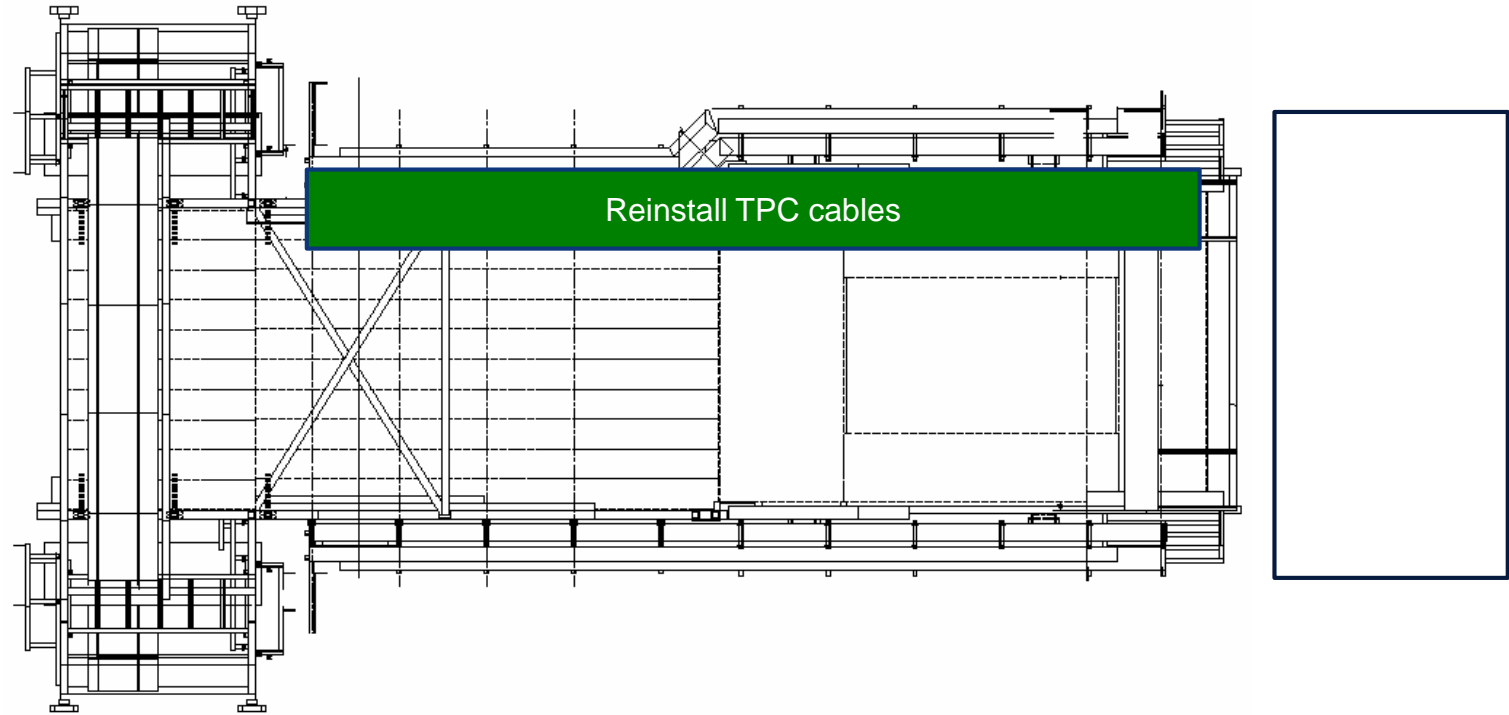

# Miniframe activities w38 – Fri 20 Sep 2019

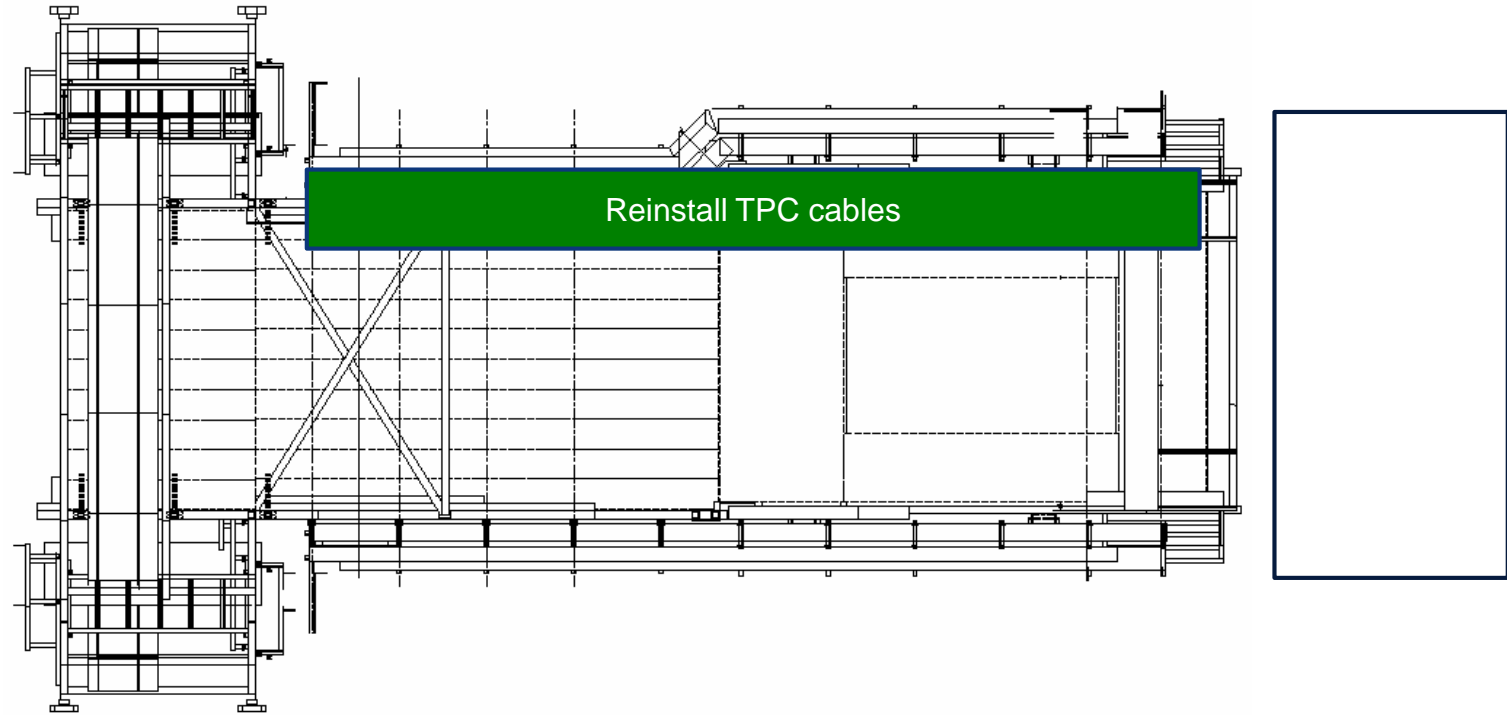

# Day-by-day sequence w39



# UX25 activities w39 – Mon 23 Sep 2019

CR0: install fire detection system (whole week)

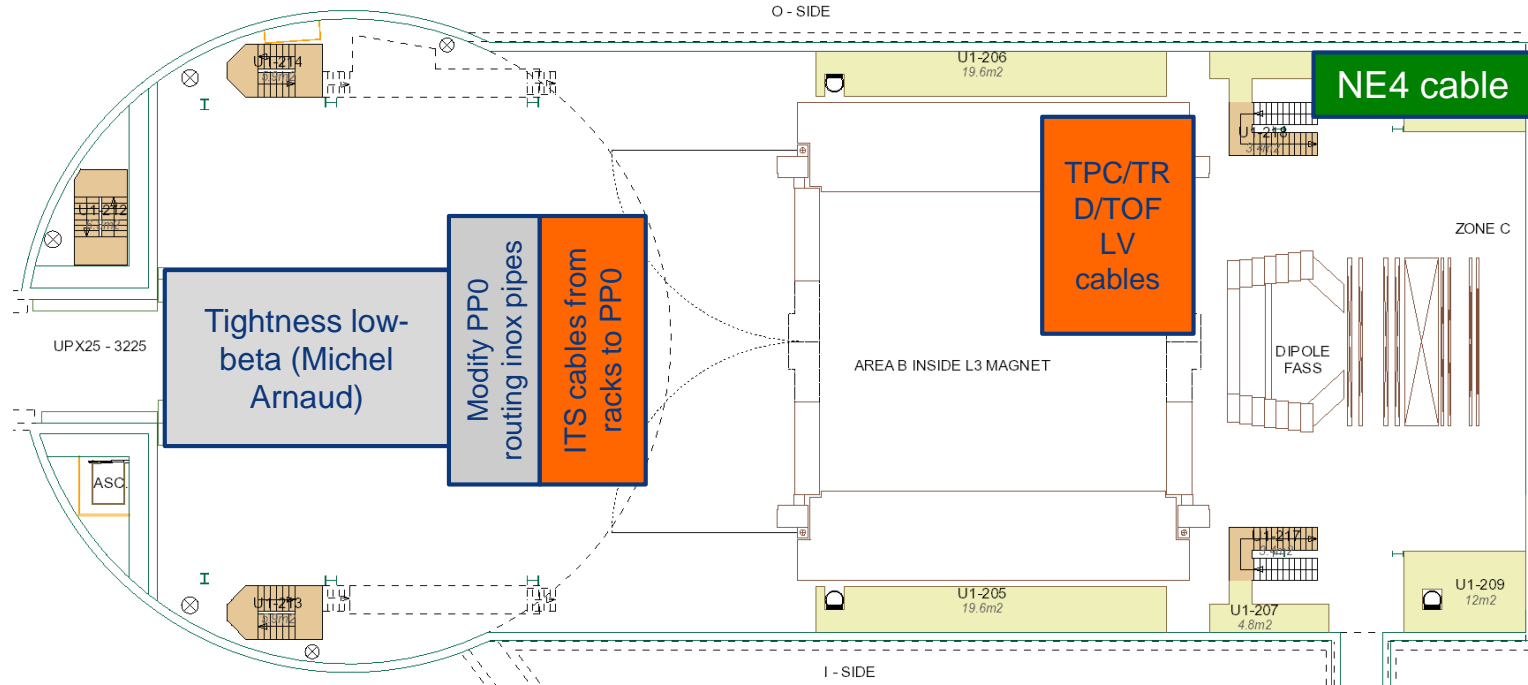

# UX25 activities w39 – Tue 24 Sep 2019

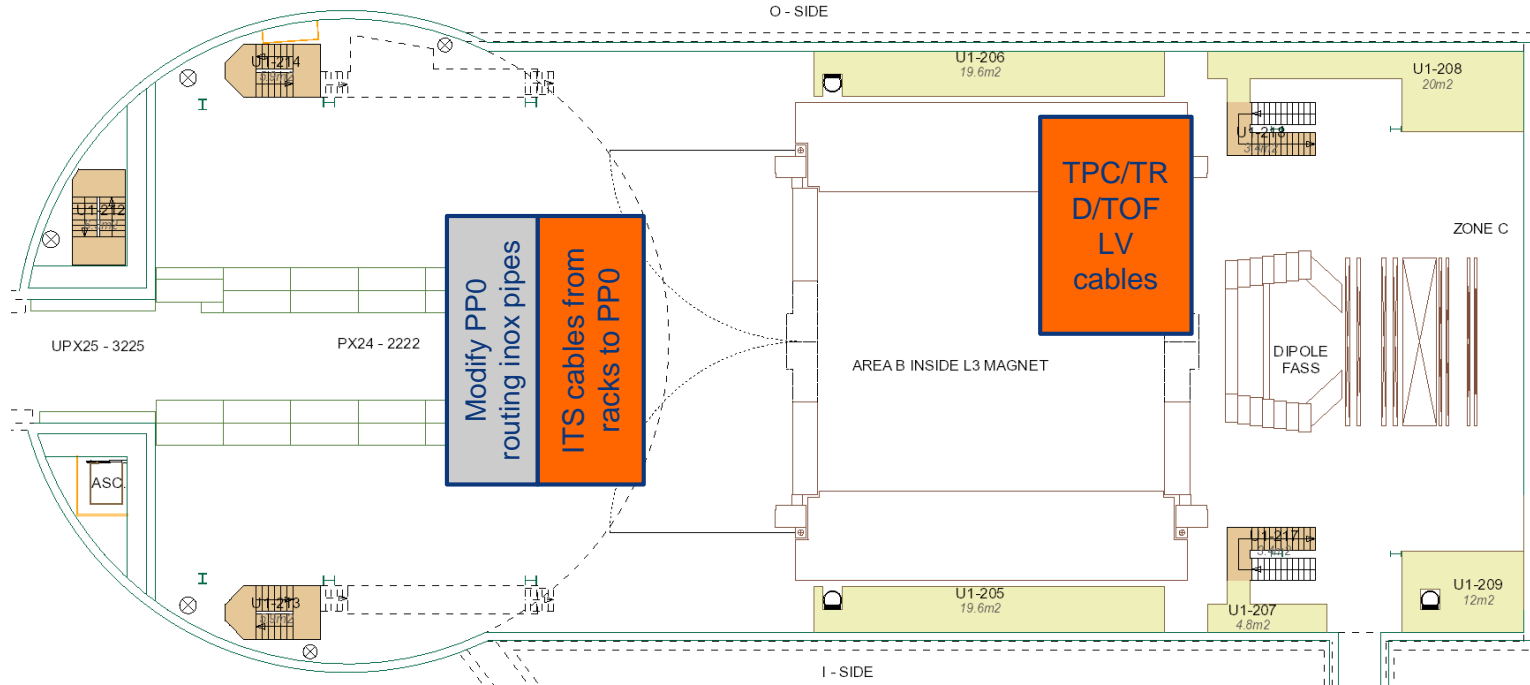



# UX25 activities w39 – Wed 25 Sep 2019

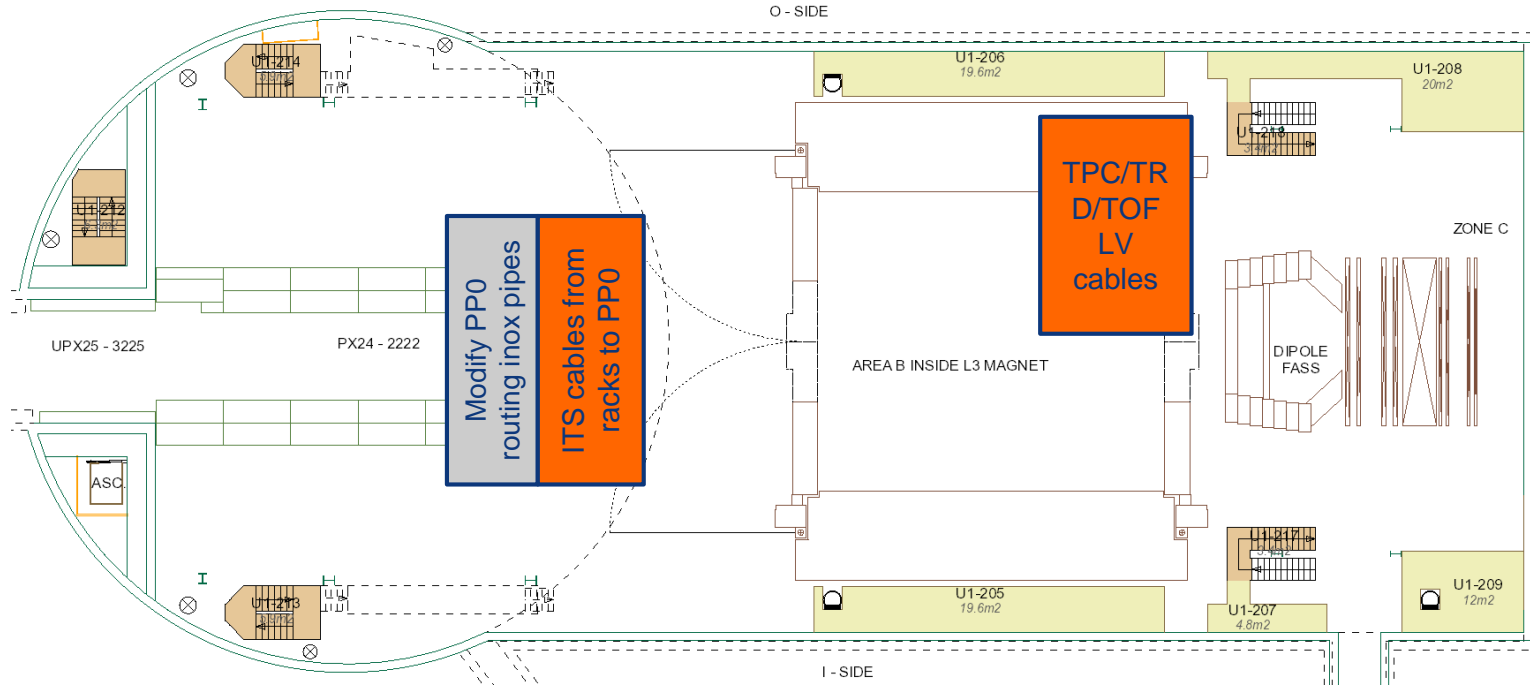

# UX25 activities w39 – Thu 26 Sep 2019

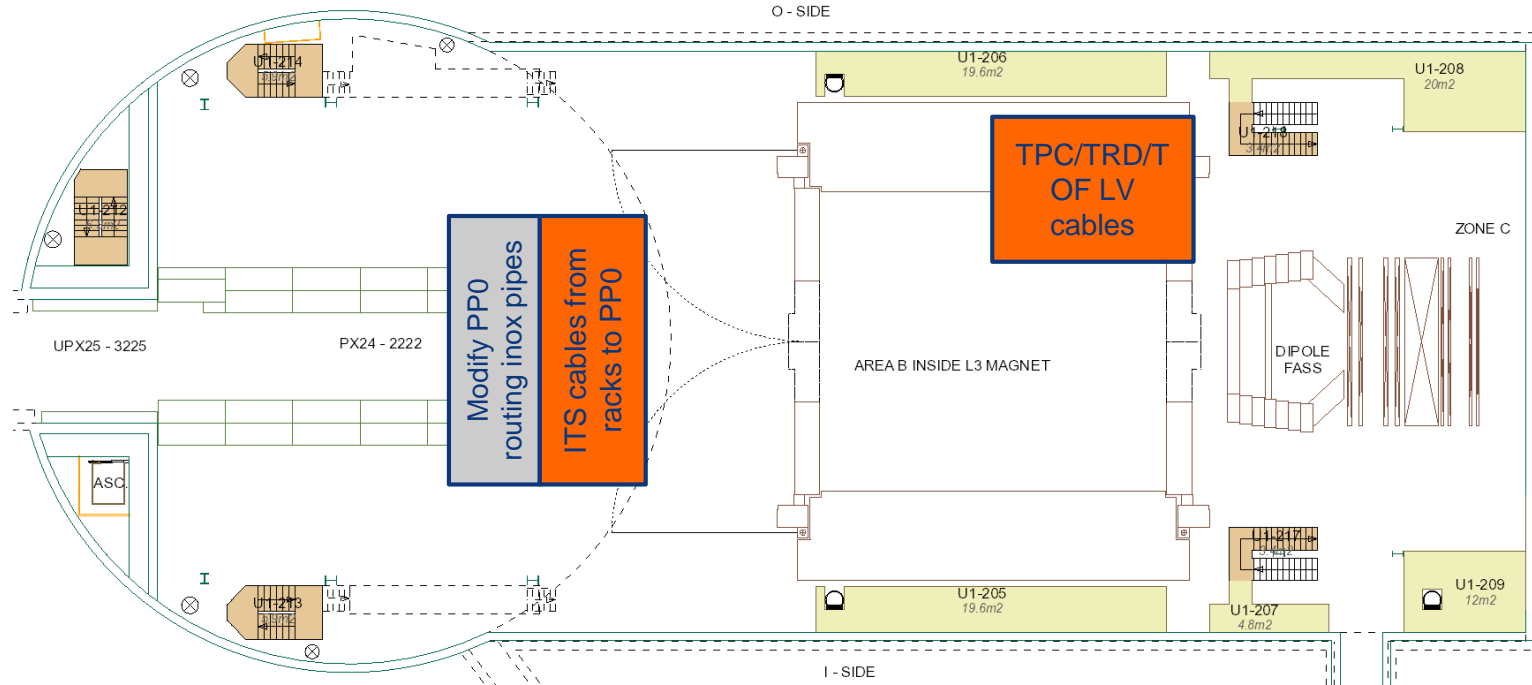

# UX25 activities w39 – Fri 27 Sep 2019

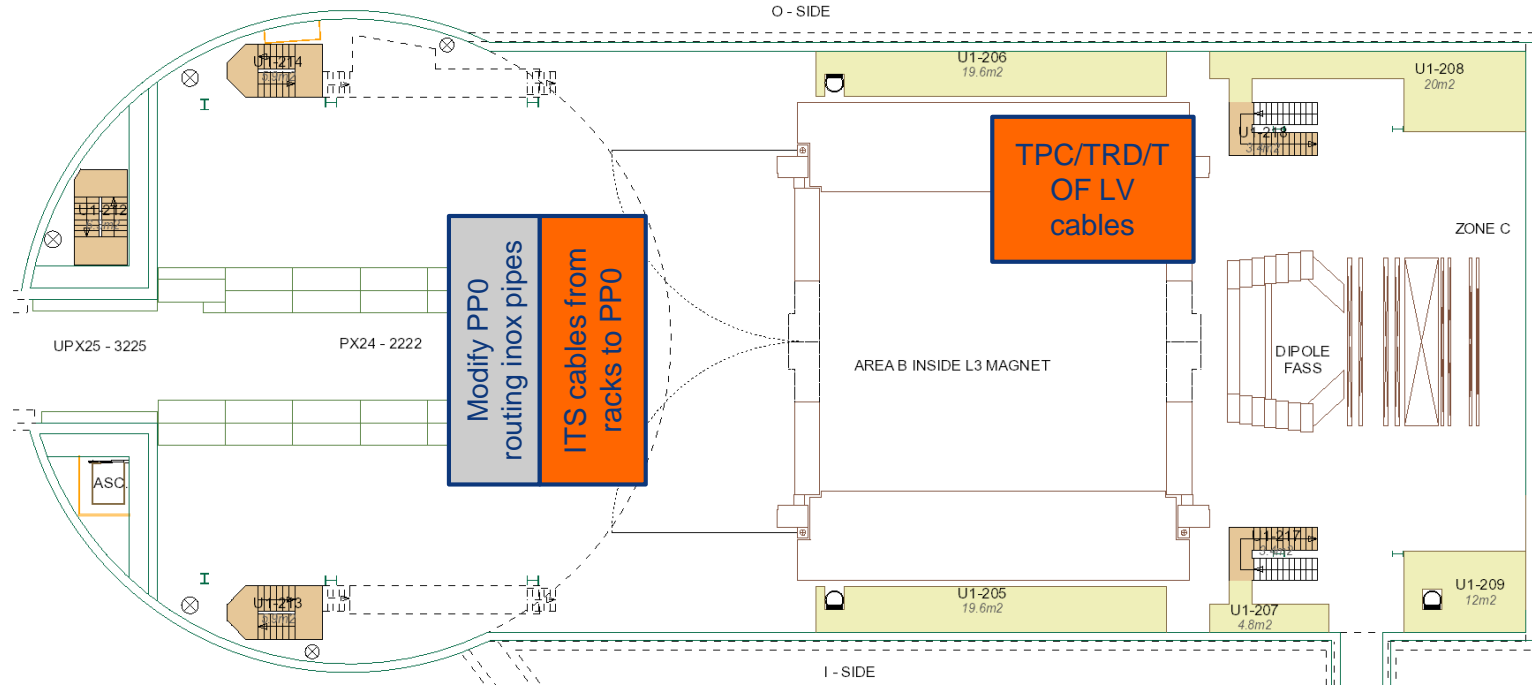

# SXL2 activities w39 – Mon 23 Sep 2019

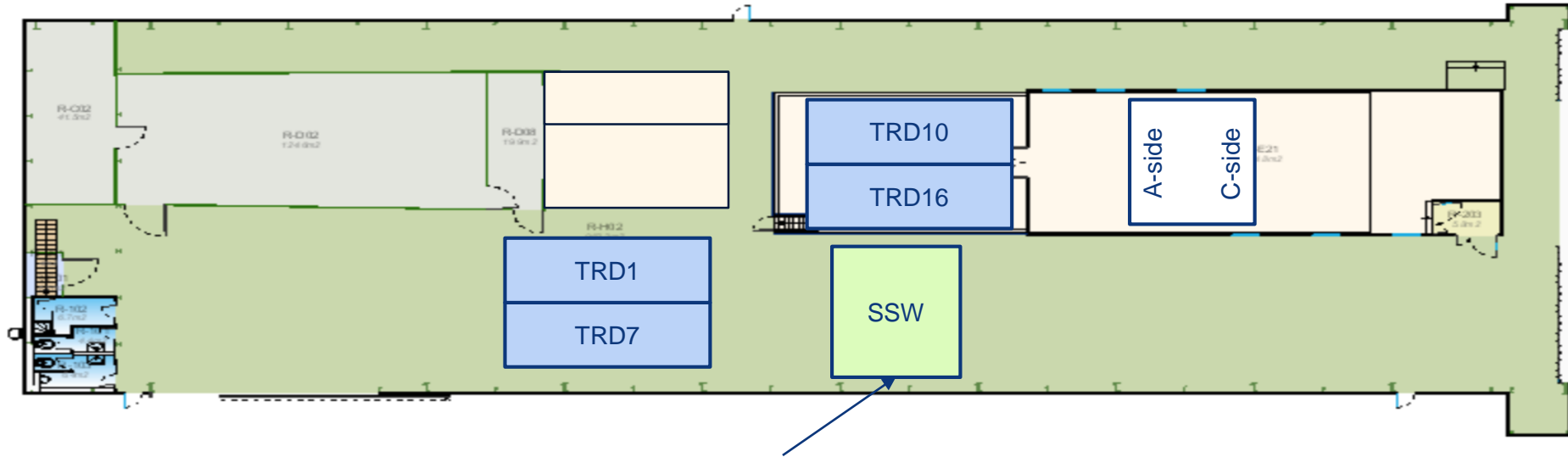

ALTEAD+TPC+P2tech: install C-side SSW onto lifting jig

# SXL2 activities w39 – Tue 24 Sep 2019

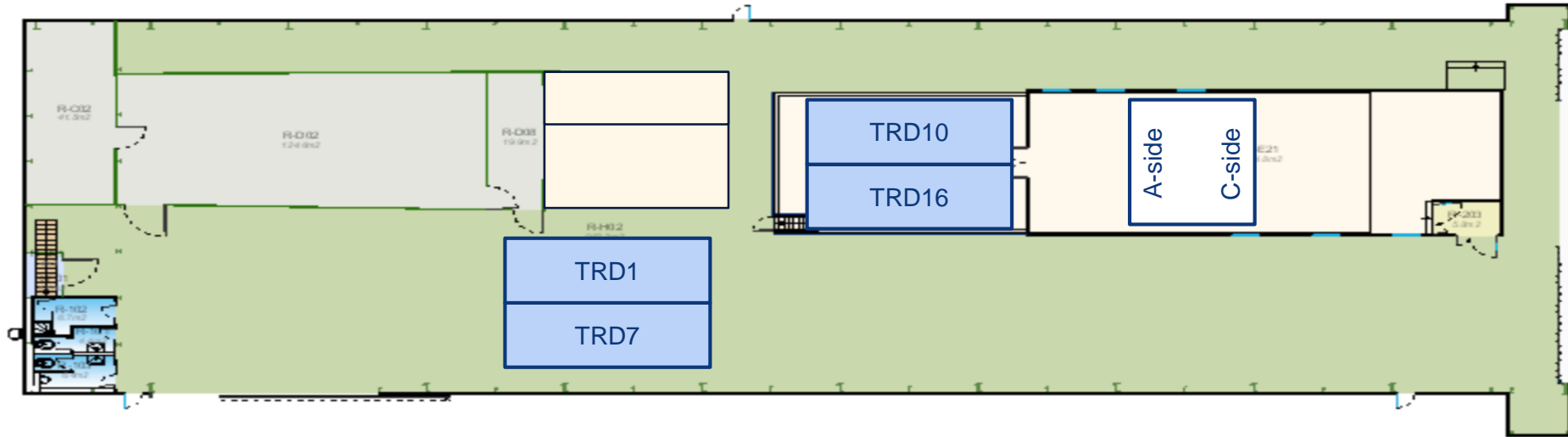

# SXL2 activities w39 – Wed 25 Sep 2019

ALTEAD+P2tech: open cleanroom roof, remove small scaffolding, remove YP extension and fan

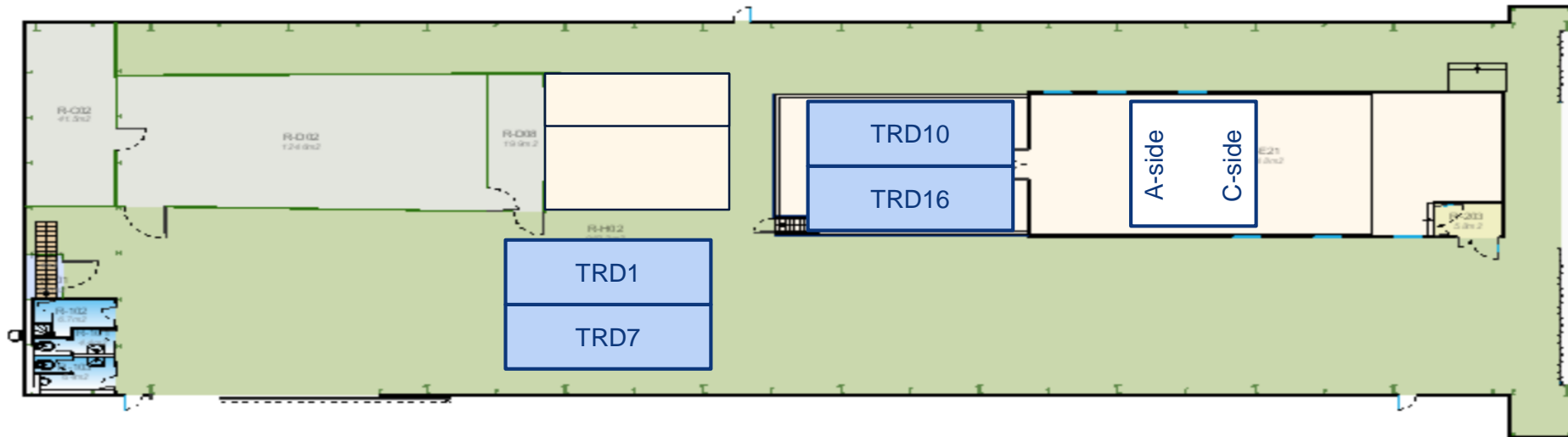

# SXL2 activities w39 – Thu 26 Sep 2019

ALTEAD+P2tech: install I-bars C-side, remove A-side I-bars, install SSW A-side

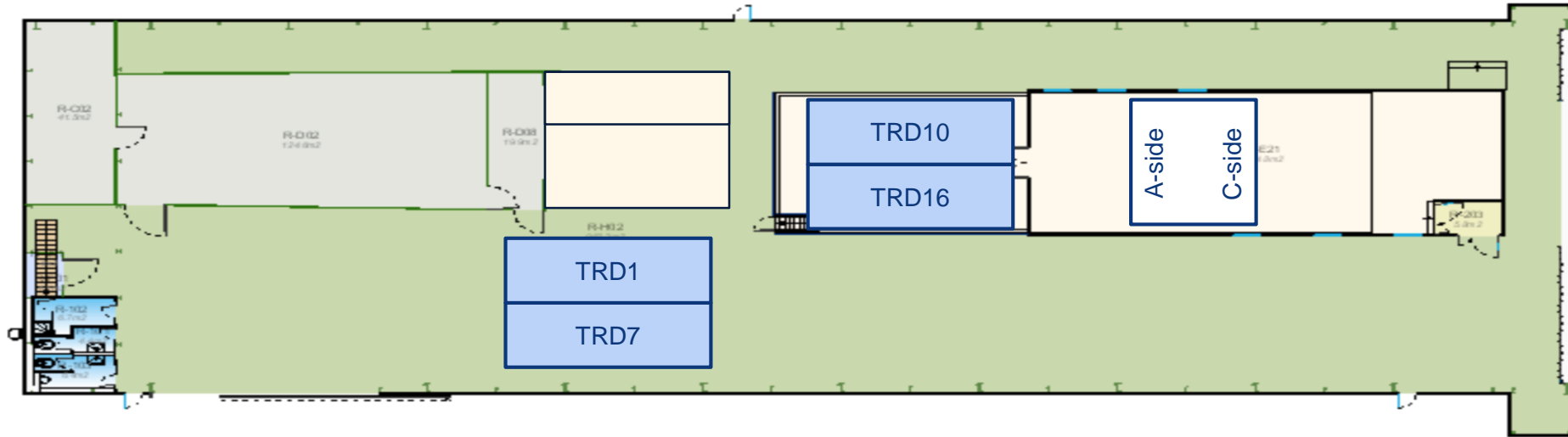

# SXL2 activities w39 – Fri 27 Sep 2019

ALTEAD+P2tech: install SSW-C side, install scaffolding A-side

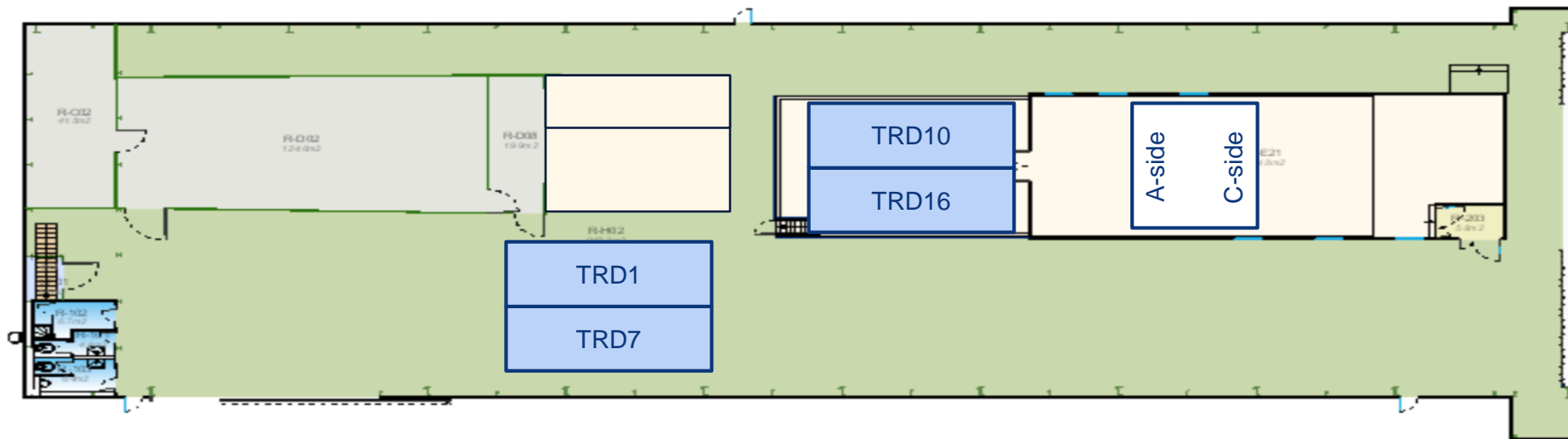



# Miniframe activities w39 – Mon 23 Sep 2019

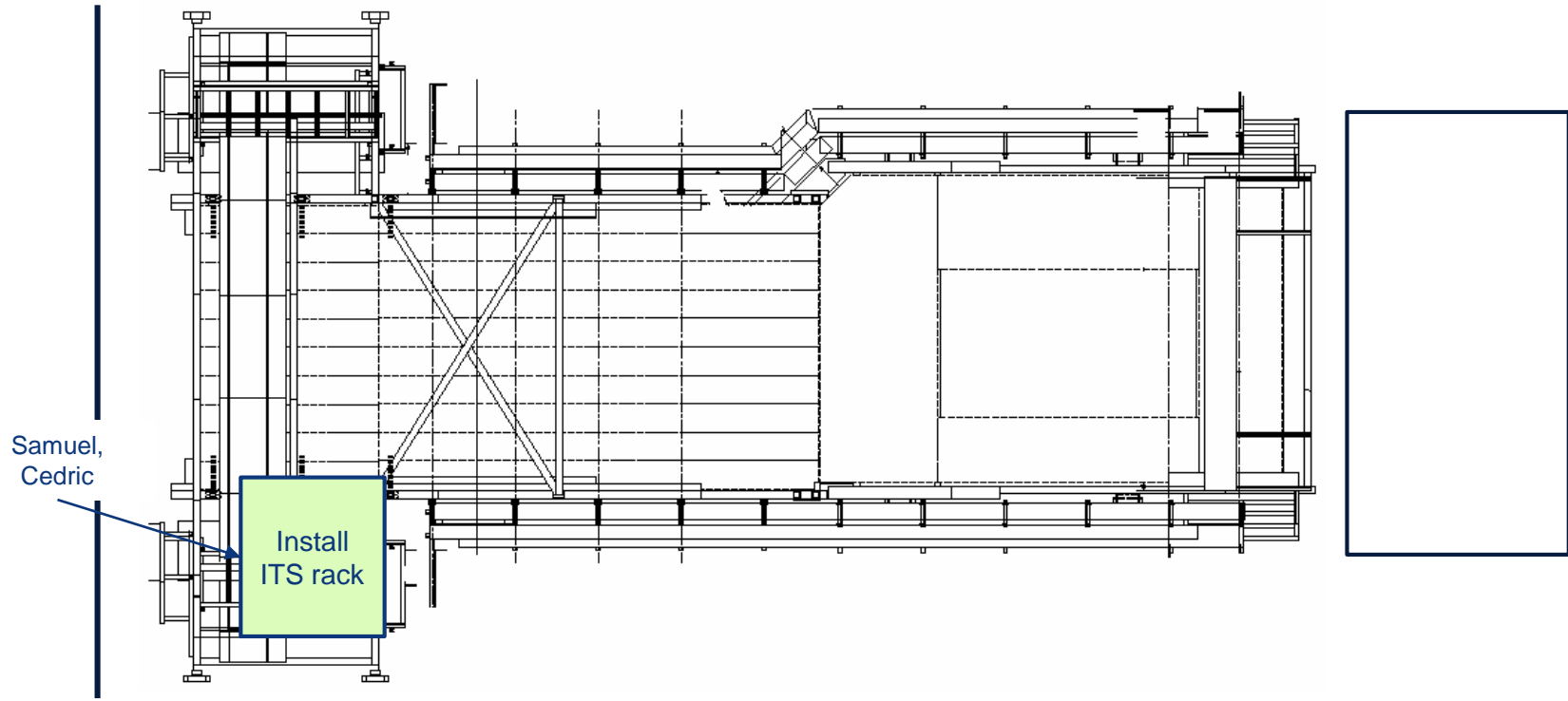

# Miniframe activities w39 – Tue 24 Sep 2019

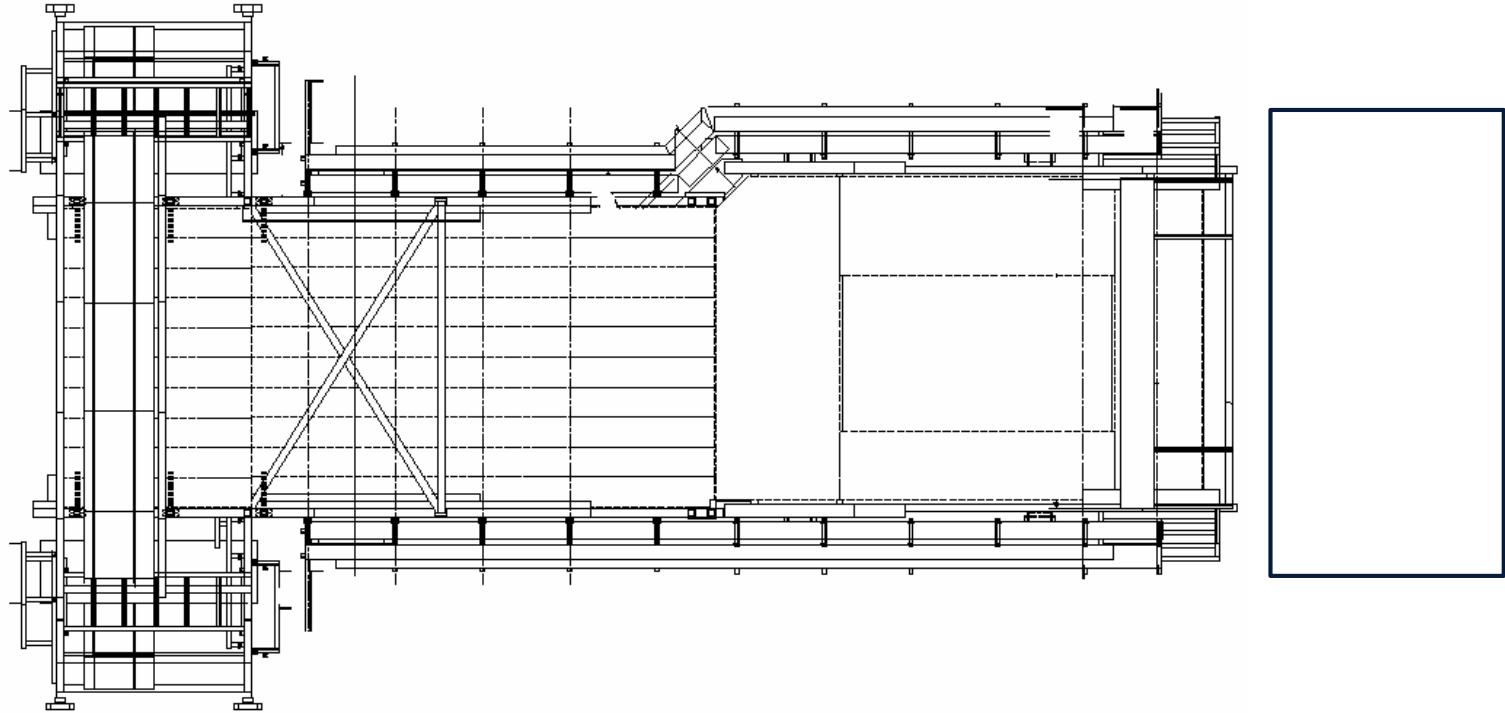

# Miniframe activities w39 – Wed 25 Sep 2019

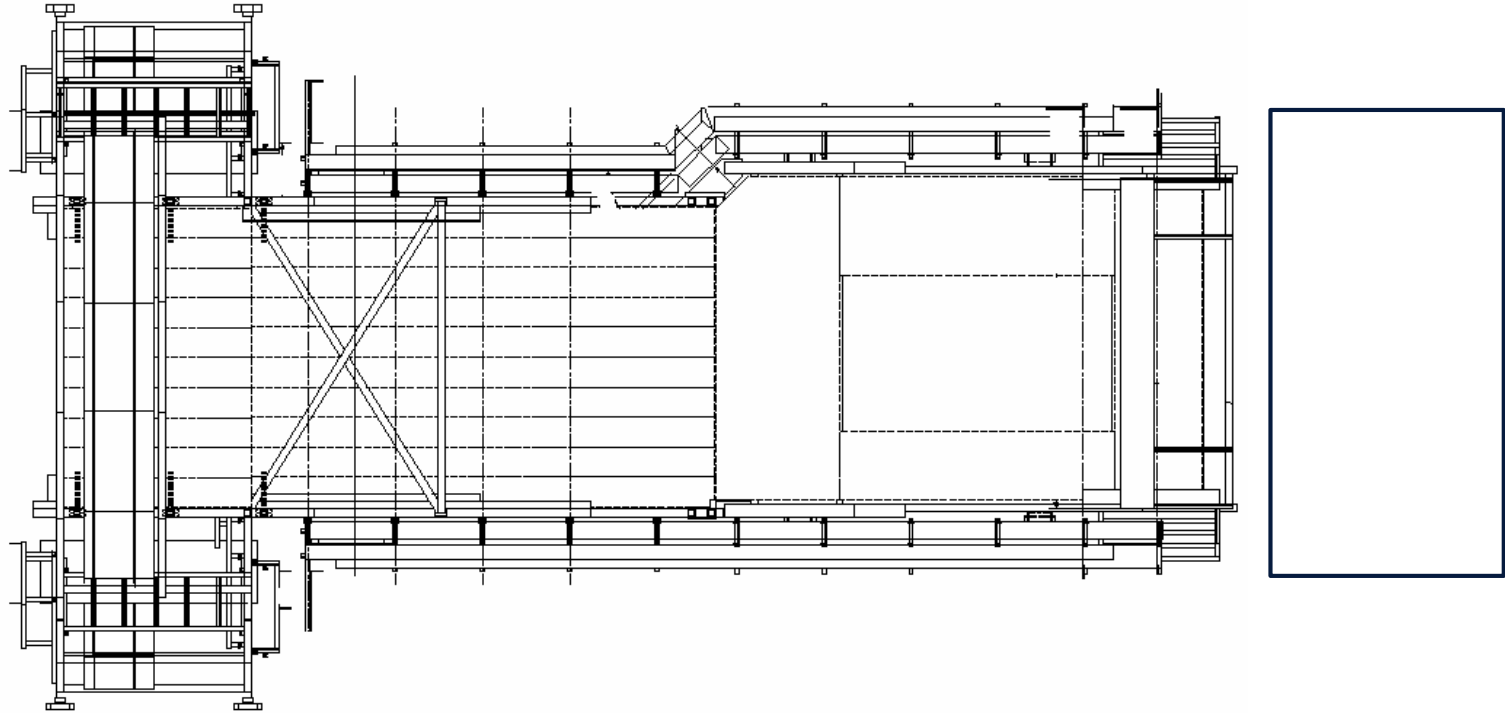

# Miniframe activities w39 – Thu 26 Sep 2019

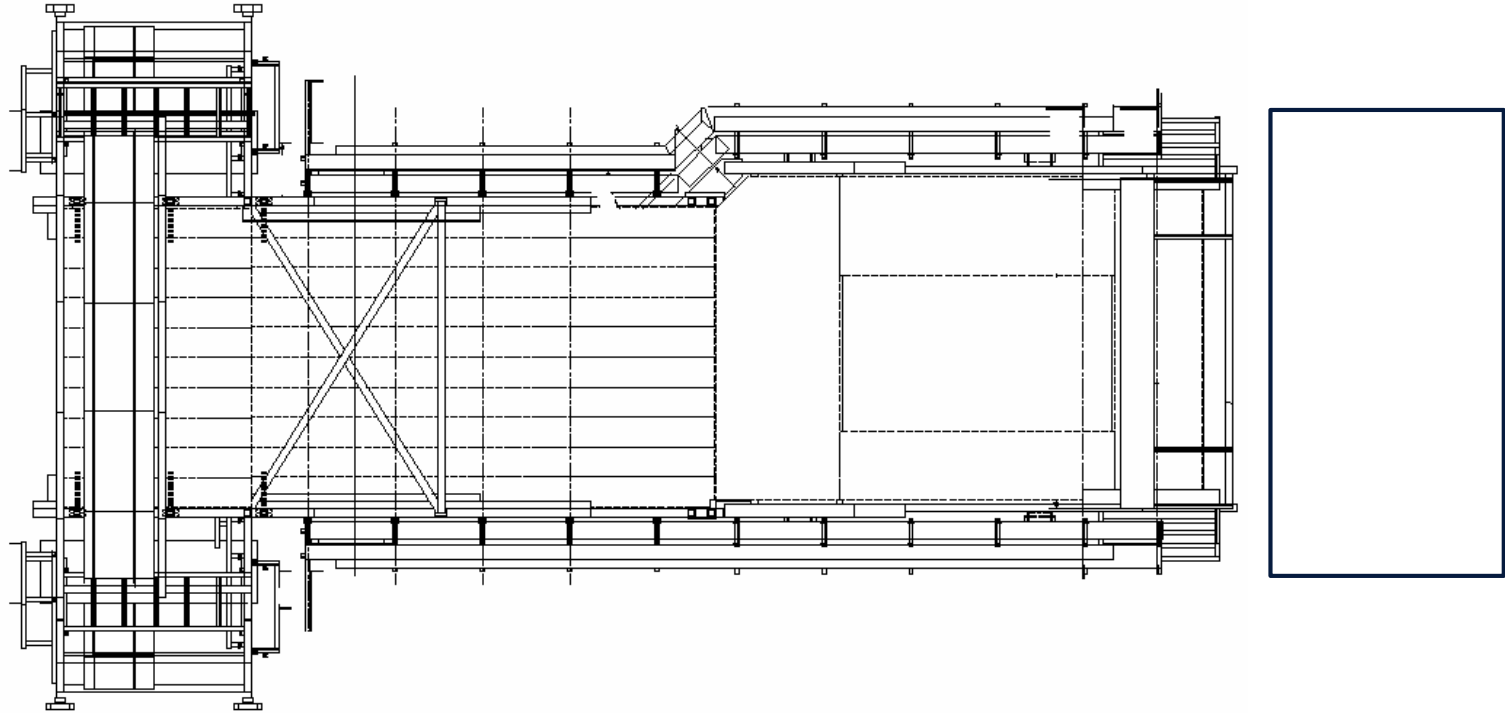

# Miniframe activities w39 – Fri 27 Sep 2019

