

Setup of the heat transfer inside the TOF-MPD detector

Authors:

Jakub Zdziebłowski

Krystian Idźkowski

Supervisor:

Msc. Krystian Rosłon



**TEMPERATURE
STABILISATION
SYSTEMS**

Engineering Support

Outline



- Introduction
- Hardware
- Software
- Problems
- Results

MPD-TOF

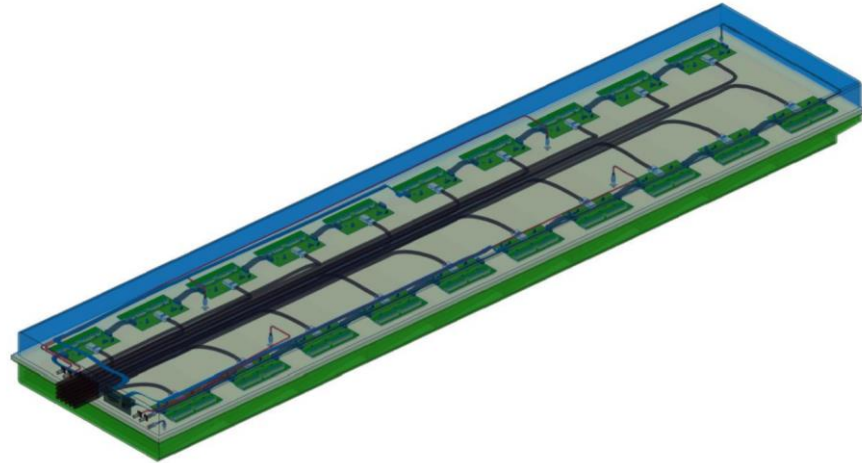

Layout of front-end electronics

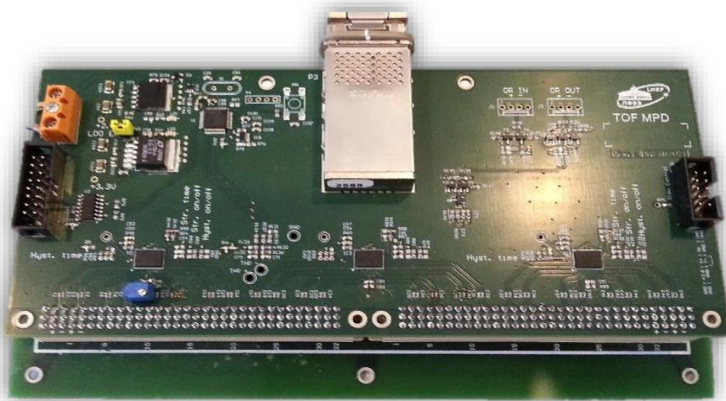

Preamplifier board
(ref. TOF MPD Collaboration JINR)

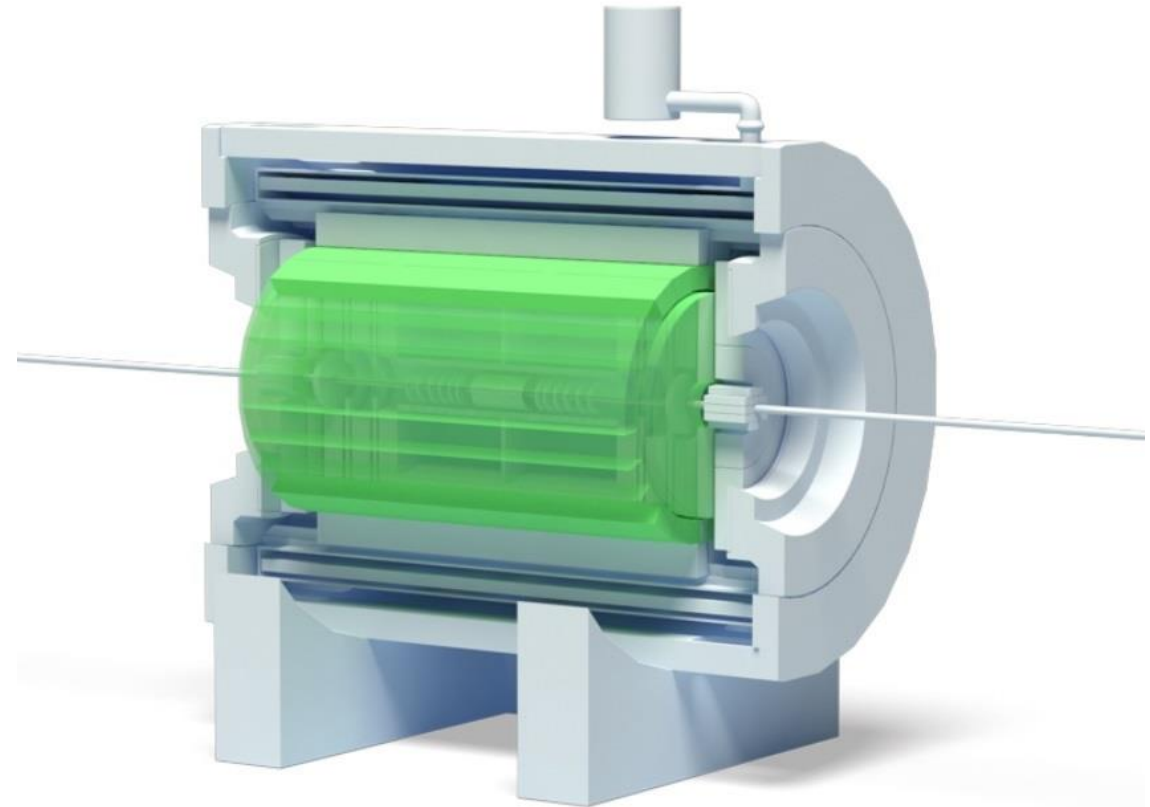

Sensors arrangement

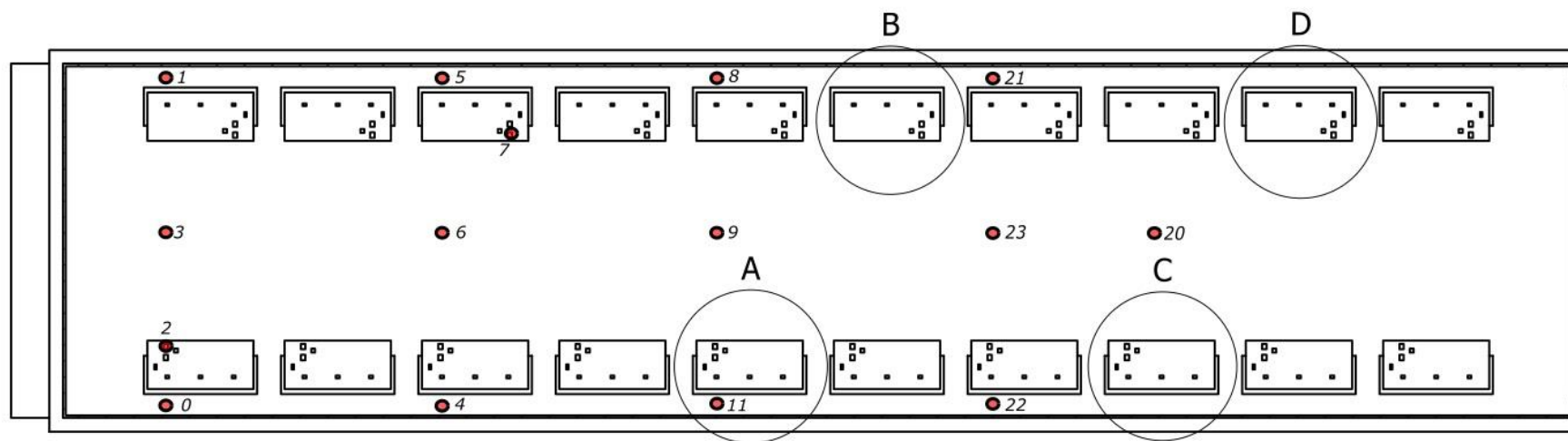
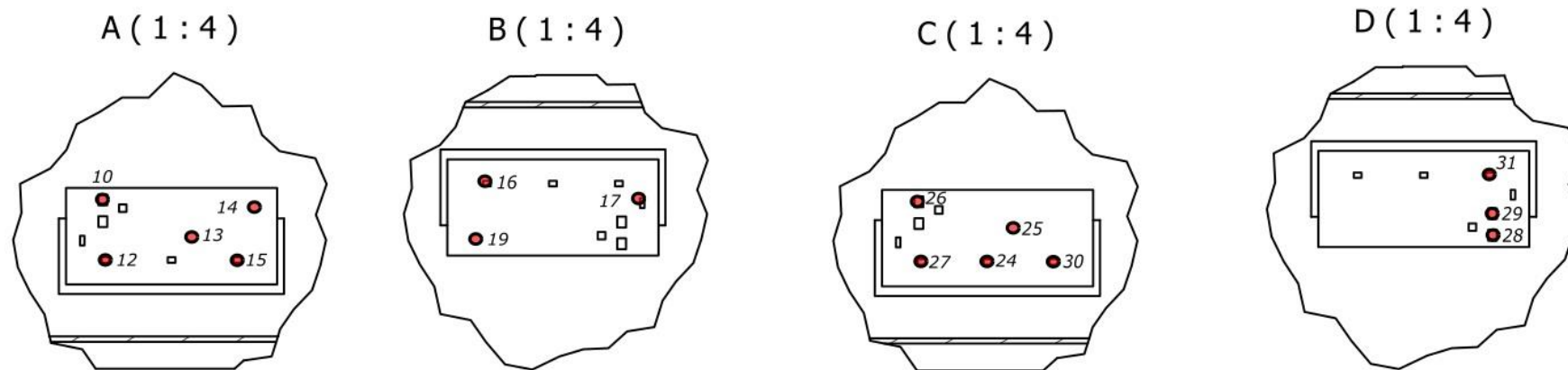

● 18
(na zewnątrz)

Sensors arrangement



Idea of multiplexing

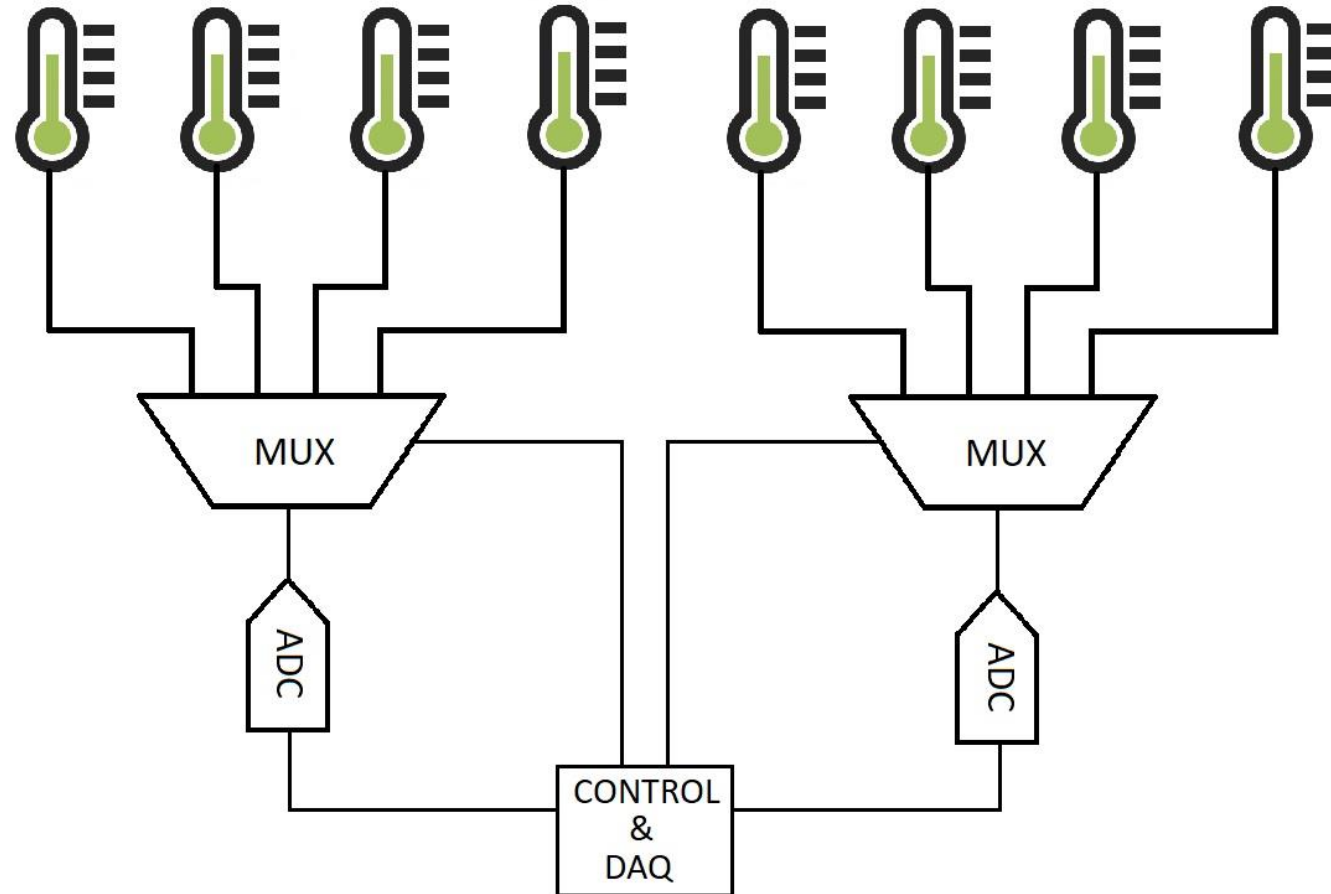

Electrical block diagram

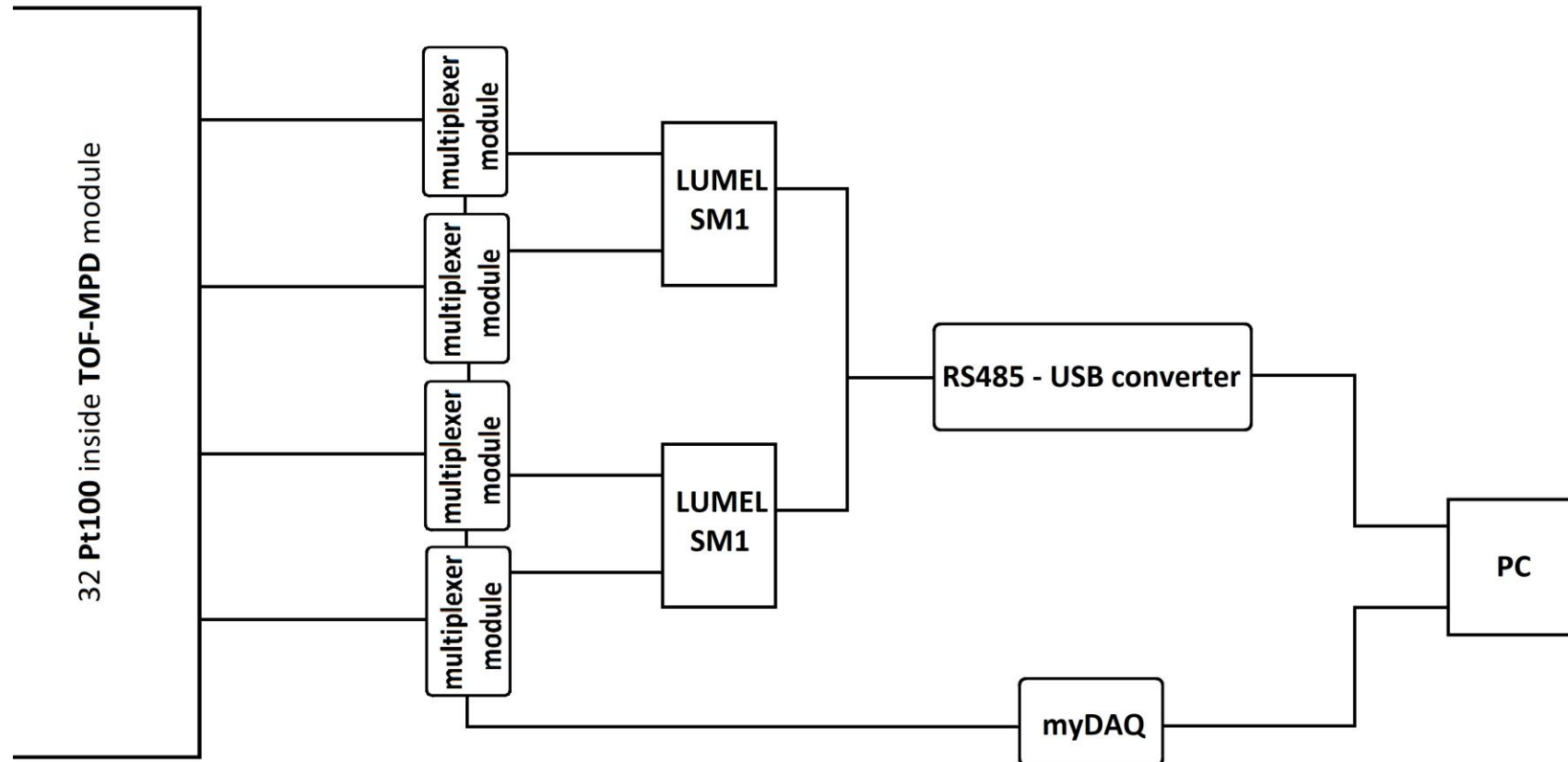

Figure: Electrical block diagram of the device

Used equipment



- 2x LUMEL SM1 analog inputs modules,
- LUMEL PD10 RS485-USB converter,
- 4x 8-channel relay modules,
- 32 Pt100 temperature sensors,
- NI myDAQ device;

LUMEL SM1



- Two multi-use channels (dedicated mode for Pt100),
- RS485 interface,
- MODBUS protocol in RTU or ASCII mode,
- Baud rate: 2400 - 115200 bit/s,
- Response time: 300ms (max),
- Temperature measuring range: $-200 \div +850^{\circ}\text{C}$,
- Measurement error: $\pm 0.2\%$ of range;



fot. www.lumel.com.pl

Relay modules



- 8 channels,
- Optocoupling,
- Relay model: JQC3F,
- Coil voltage: 5V
(power requirement: 0.36W),
- Switch time: $\leq 10\text{ms}$ (according to datasheet),
- On-state resistance: 100m Ω ;

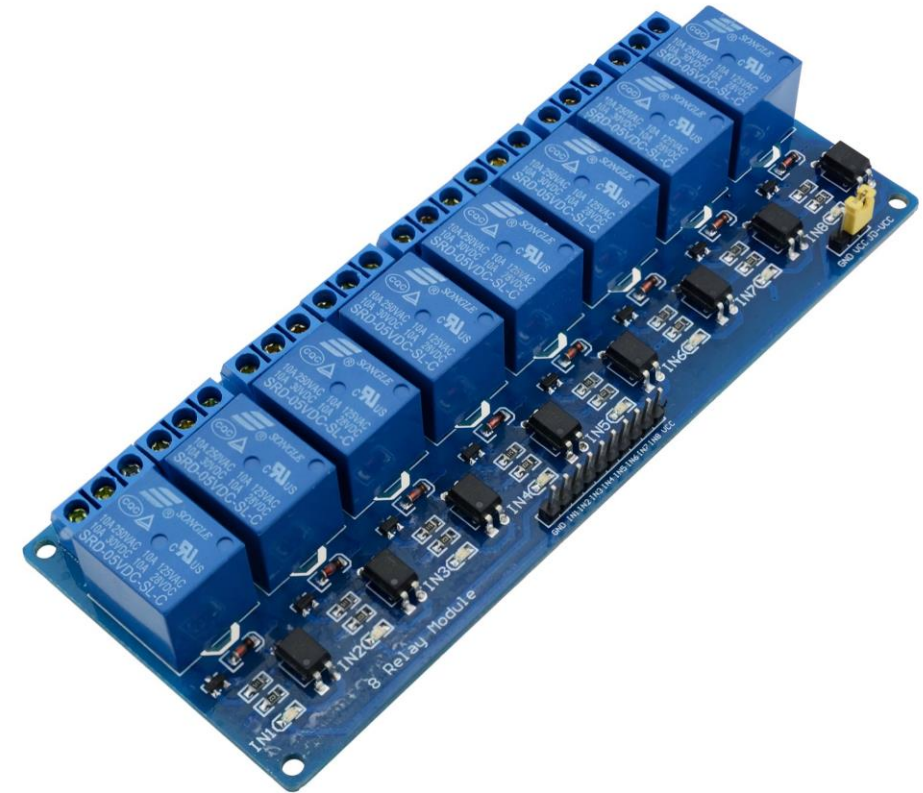

fot. ebay.ru

NI myDAQ



myDAQ Student Data Acquisition Device

(Used as 8 channel digital output)

Digital output parameters:

- 3.3V TTL logic,
- Total power: 500mW;



foto. National Instruments

Setup assembly



LabVIEW software

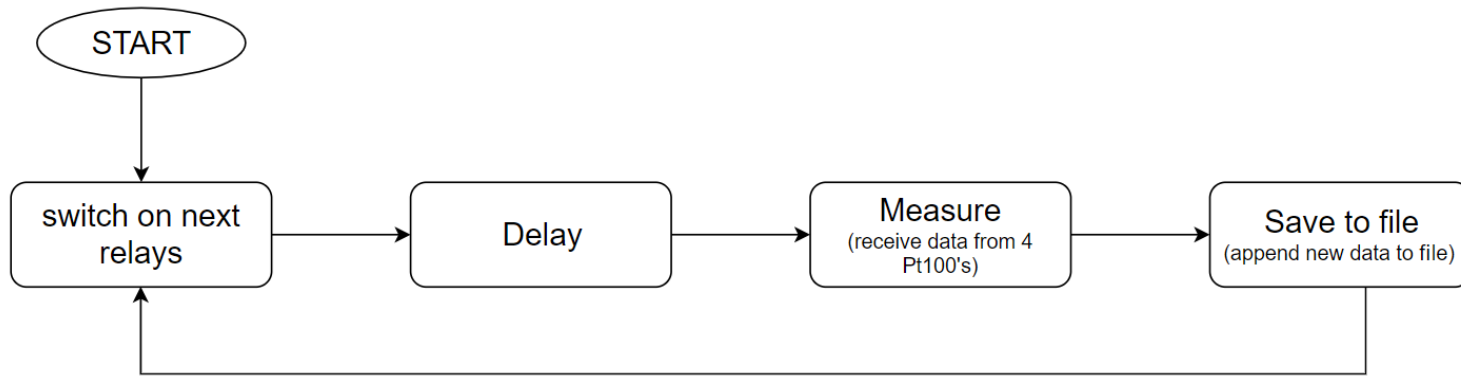
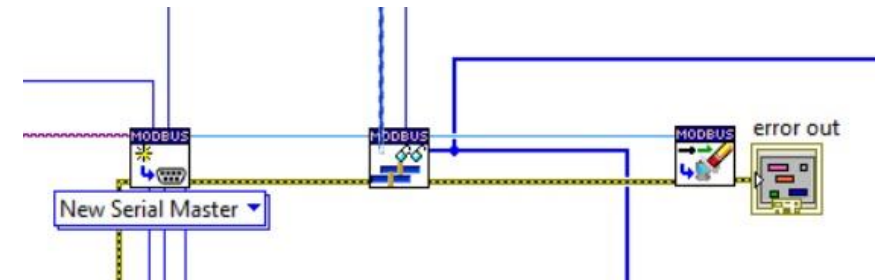
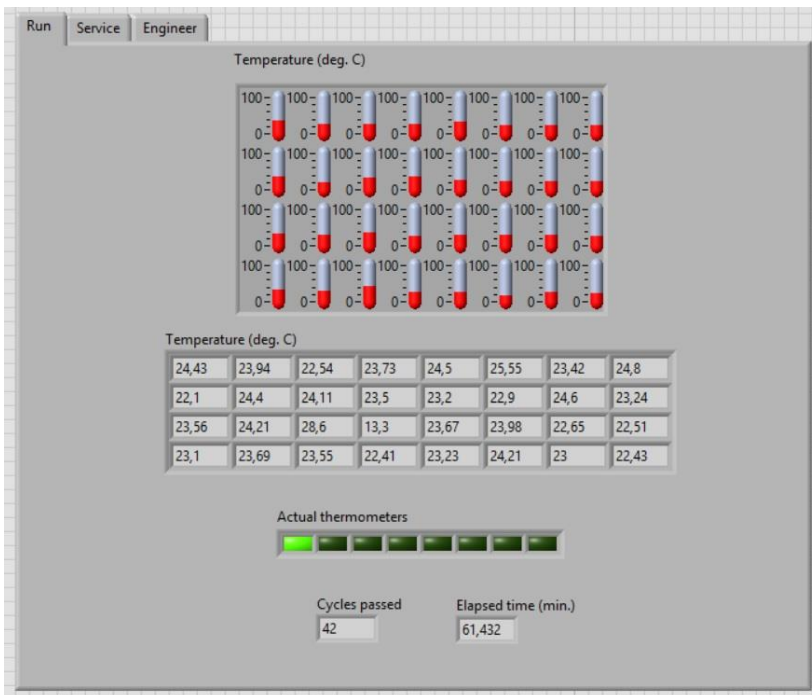

Figure: Block diagram



LabVIEW software



Run panel

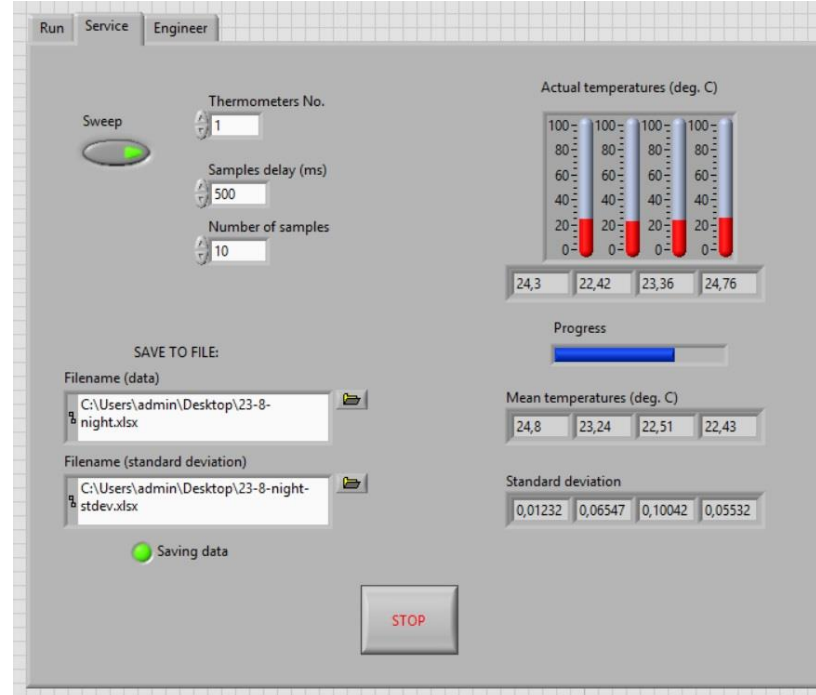

Service panel

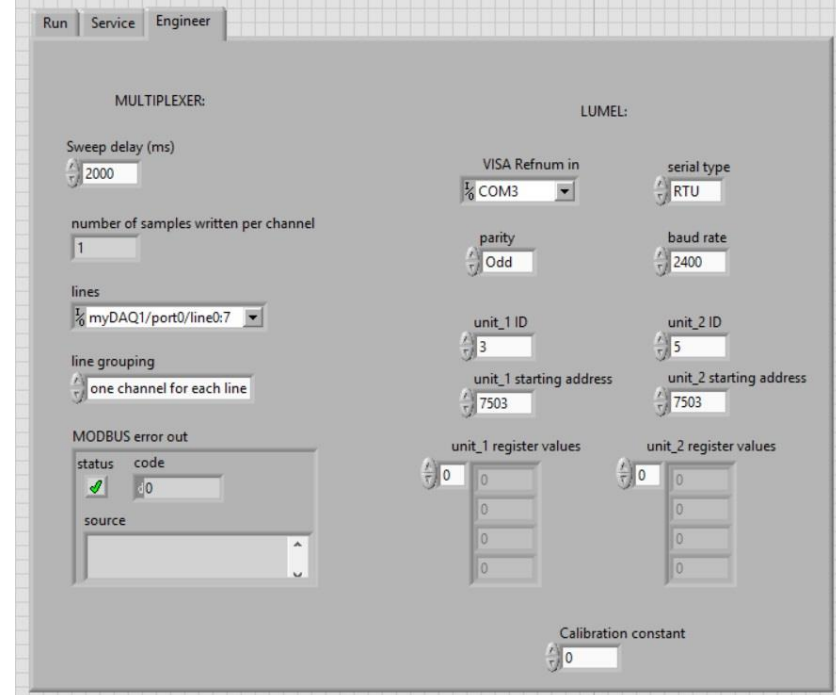

Engineering panel

Problems: 1. LUMEL transient state



Figure: Measured temperature in the function of time

applied actions:

- Adding delay after switching relays,
- Adding delay between single measurements;

Problems: 2. 2. "frozen" temperature readings

	A	B	C	D	E	F	G	H
1	Time	Untitled	Untitled 1	Untitled 2	Untitled 3	Untitled 4	Untitled 5	Untitl
2	23.08.2019 18:01:22,944	25,39866	25,47682	25,85861	25,98752	25,15168	25,66554	25,99:
3	23.08.2019 18:02:46,718	25,42921	25,45155	25,92183	26,11533	25,1859	25,6947	26,00:
4	23.08.2019 18:04:10,526	25,39511	25,46025	25,85822	26,21064	25,18863	25,70519	25,97:
5	23.08.2019 18:05:34,338	25,40711	25,48772	25,87526	26,22634	25,14684	25,72592	25,98:
6	23.08.2019 18:06:58,228	25,39141	25,50673	25,8876	26,25758	25,17967	25,7147	25,97:
7	23.08.2019 18:08:22,070	25,3911	25,515	25,54016	26,32876	25,18568	25,70964	25,99:
8	23.08.2019 18:09:45,922	25,39673	25,49921	25,54016	26,34184	25,15665	25,75563	25,98:
9	23.08.2019 18:11:09,859	25,41184	25,53154	25,54016	26,4453	25,197	25,77015	25,96:
10	23.08.2019 18:12:33,805	25,46632	25,51509	25,54016	26,5844	25,2047	25,75614	25,96:
11	23.08.2019 18:13:57,835	25,47276	25,53356	25,54016	26,69876	25,1786	25,73497	25,98:
12	23.08.2019 18:15:21,872	25,48425	25,5508	25,54016	26,44689	25,17759	25,74913	26,01:
13	23.08.2019 18:16:45,893	25,40804	25,51015	25,54016	26,36599	25,17935	25,75073	26,00:
14	23.08.2019 18:18:09,878	25,40836	25,51511	25,54016	26,53426	25,19122	25,74406	26,02:
15	23.08.2019 18:19:33,881	25,44025	25,51565	25,54016	26,35548	25,21791	25,66571	26,10:
16	23.08.2019 18:20:57,966	25,40712	25,46043	25,54016	26,34001	25,19721	25,54044	25,97:
17	23.08.2019 18:22:22,052	25,42749	25,45565	25,54016	26,58437	25,16083	25,73293	25,98:
18	23.08.2019 18:23:46,227	25,40967	25,48089	25,54016	26,4928	25,16556	25,70772	25,99:
19	23.08.2019 18:25:10,385	25,38165	25,46852	25,54016	26,4928	25,16556	25,70772	25,99:
20	23.08.2019 18:26:34,461	25,4177	25,45533	25,54016	26,97136	25,156	25,67558	25,95:
21	23.08.2019 18:27:58,718	25,39015	25,46608	25,54016	26,30214	25,14727	25,696	25,96:
22	23.08.2019 18:29:22,995	25,3955	25,46485	25,54016	26,52242	25,12792	25,71863	25,96:
23	23.08.2019 18:30:47,193	25,41312	25,49497	25,54016	26,85268	25,16426	25,713	25,99:
24	23.08.2019 18:32:11,418	25,36907	25,47731	25,54016	27,25655	25,13685	25,70609	25,97:
25	23.08.2019 18:33:35,796	25,39706	25,4685	25,93752	27,21991	25,14978	25,68518	25,96:
26	23.08.2019 18:35:00,227	25,38164	25,44834	25,88802	26,88342	25,13264	25,73626	25,97:

Figure: Output data

- applied actions:**
- Connecting cables' shielding to ground,
 - Rearranging wires in the installation,
 - Slow down RS485 baud rate to 2400 bit/s;

Results

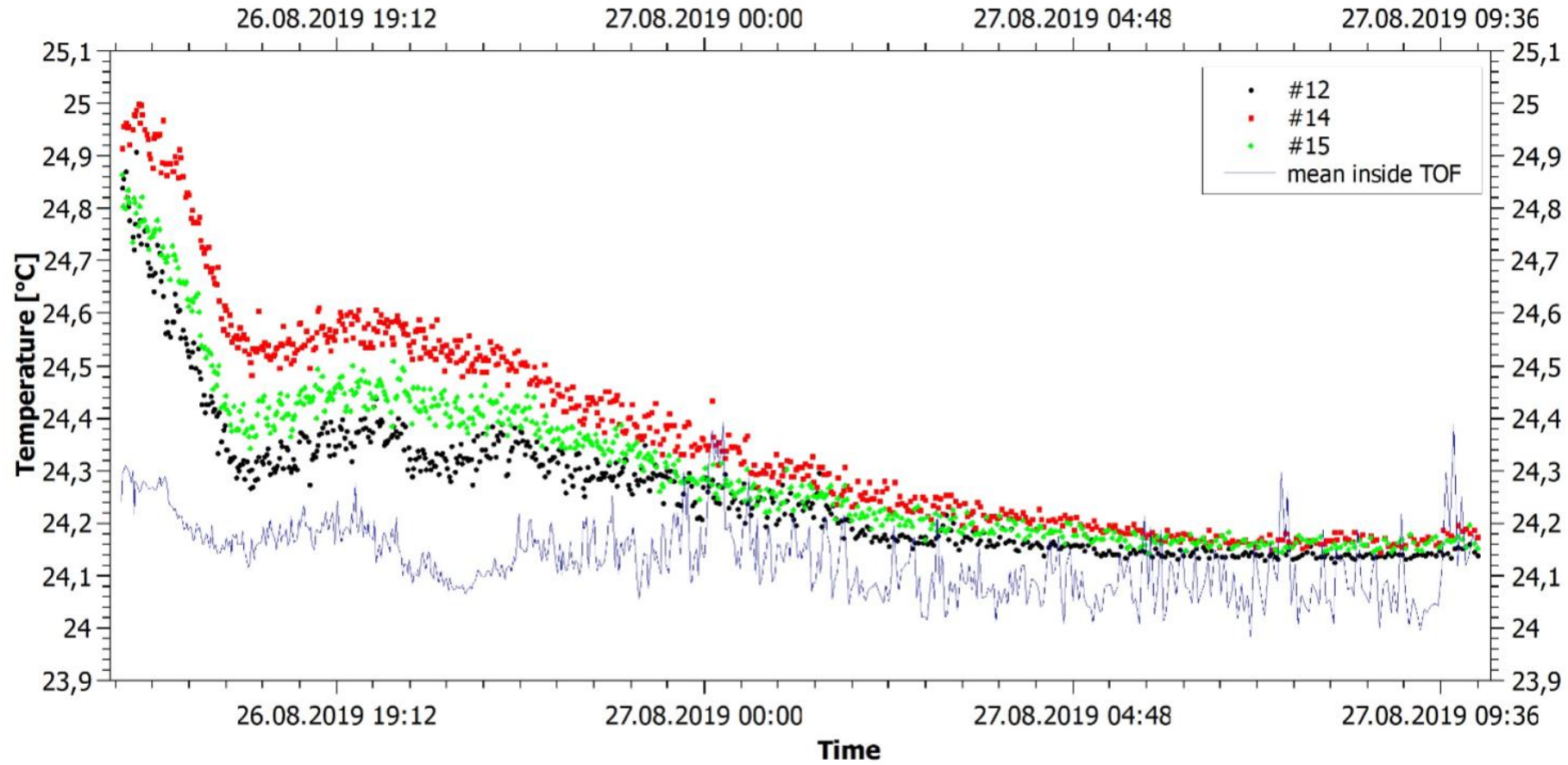

Figure: Example data

Results

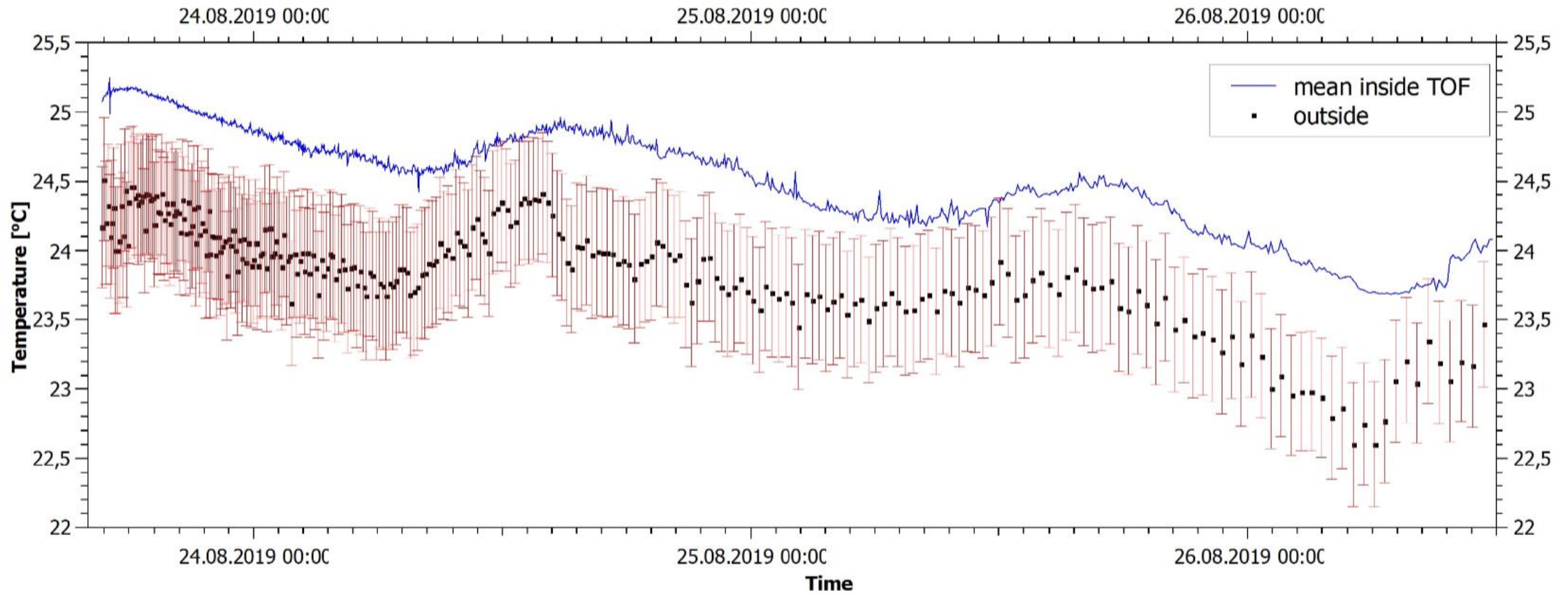

Figure: Three days measurement



Thanks for your attention

Authors:

Jakub Zdziebłowski
Krystian Idźkowski

Co-authors:

Adam Kisiel, Daniel Dabrowski, Krystian Rosłon,
Marek Peryt, Michalina Milewicz-Zalewska, Nikita Dunin

Email:

zdzieblowski@opoczta.pl



**TEMPERATURE
STABILISATION
SYSTEMS**

Engineering Support

Pt100 tolerance

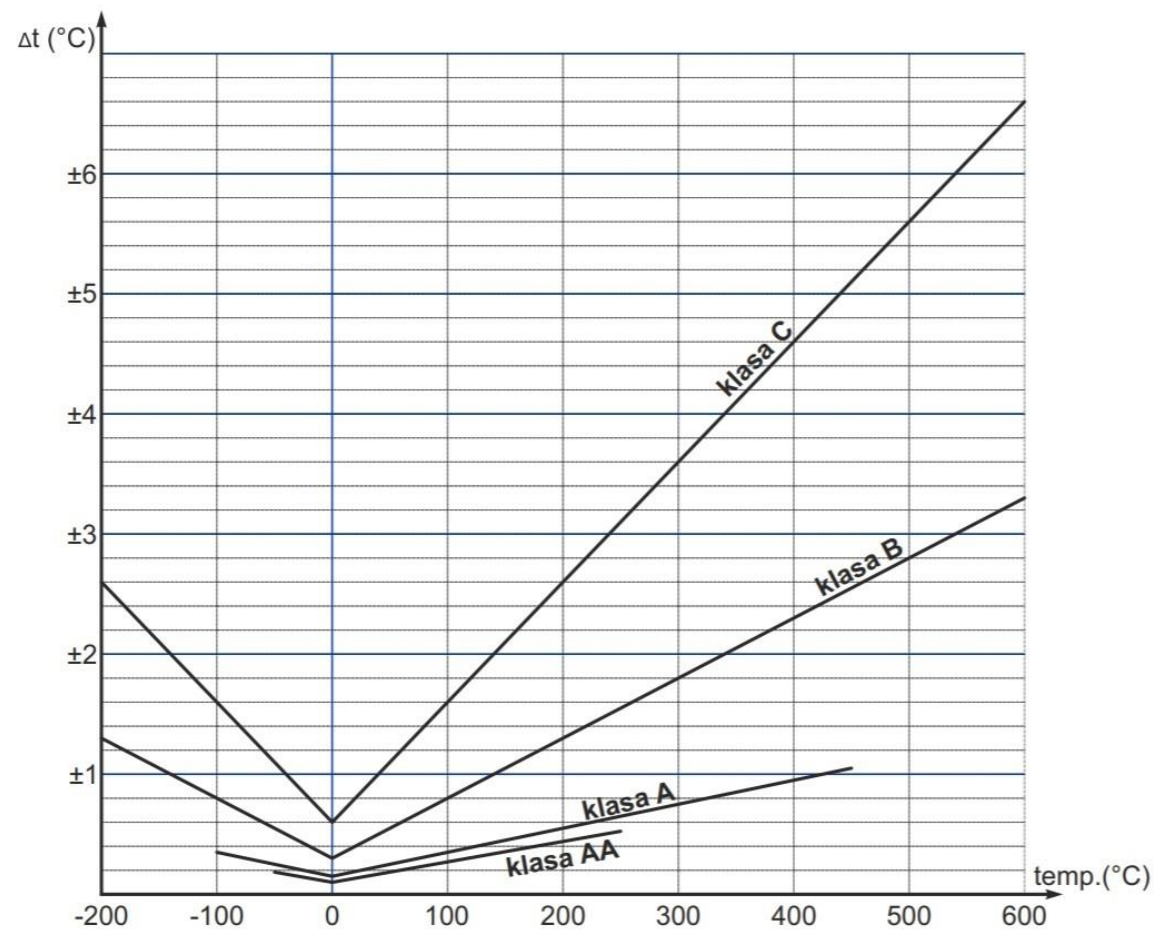

ref: www.lumel.com

Type A evaluation of uncertainty:

Arithmetic mean: $\bar{x} = \frac{1}{n} \sum_{i=1}^n x_i$

Standard deviation: $u(x) = \sqrt{s_x^2} = \sqrt{\frac{1}{n-1} \sum_{i=1}^n (x_i - \bar{x})^2}$

Type B standard uncertainty: $u(x) = \frac{\Delta x}{\sqrt{3}} = \sqrt{\frac{\Delta x^2}{3}}$

Combined (A+B) uncertainty: $u(x) = \sqrt{s_x^2 + \frac{(\Delta x)^2}{3}}$

ref. Joint Committee for Guides in Metrology Evaluation of measurement data — Guide to the expression of uncertainty in measurement. 2008.

"frozen" readings - continuation

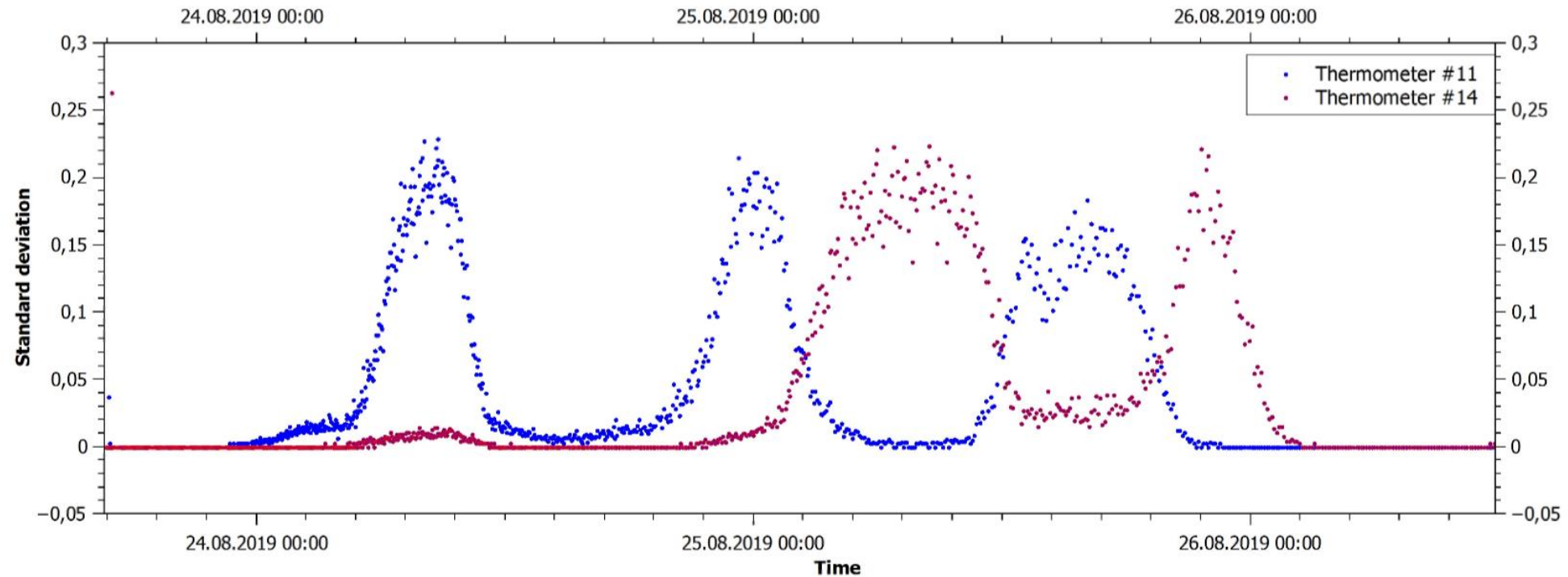

Figure: Standard deviation of temperatures in the function of time

"frozen" readings - continuation

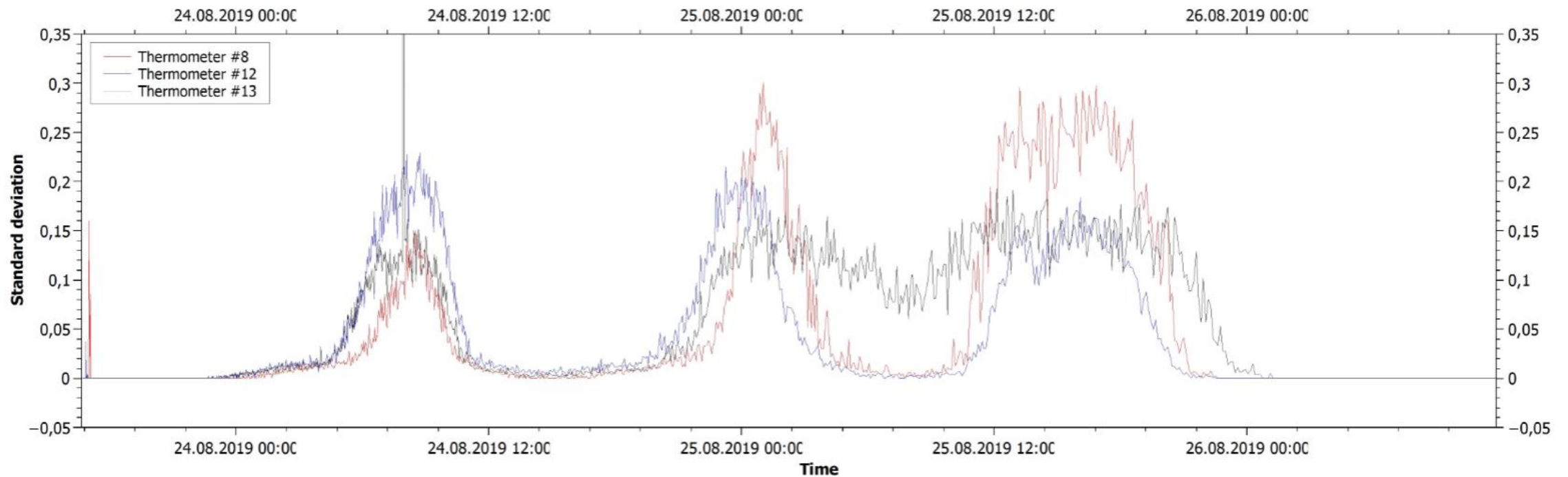

Figure: Standard deviation of temperatures in the function of time