

# NA61/SHINE detector upgrade

Dariusz Tefelski  
for the NA61/SHINE collaboration

email: [dariusz.tefelski@cern.ch](mailto:dariusz.tefelski@cern.ch)

NICA days 2019 and IVth MPD Collaboration Meeting  
21-25 October 2019, Warsaw (Poland)



- 1 Introduction and motivation
- 2 TPC readout upgrade
- 3 Vertex Detector Upgrade
- 4 TDAQ and DCS upgrade
- 5 Projectile Spectator Detector upgrade
- 6 Time of Flight upgrade
- 7 Summary

# NA61/SHINE spectrometer in 2018 (before the upgrade)

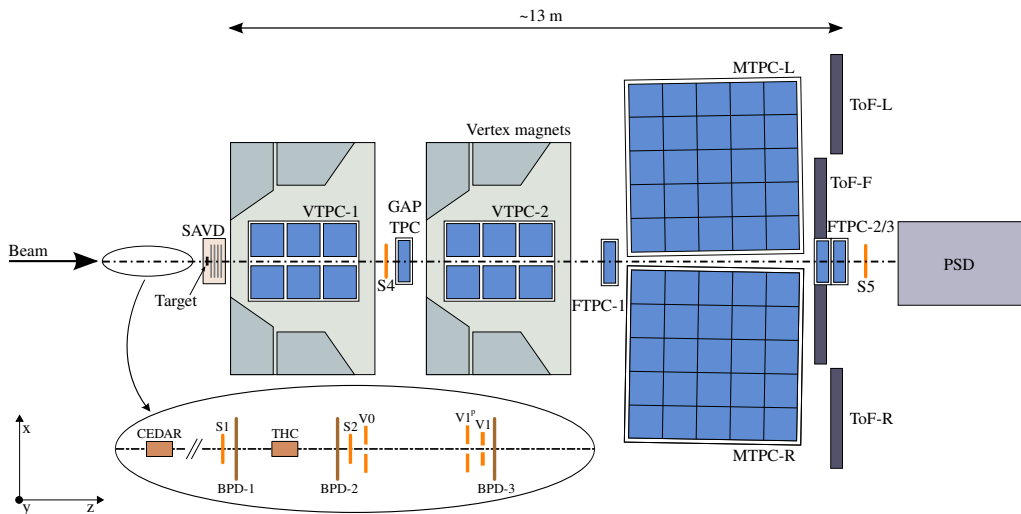

NA61/SHINE facility at the CERN SPS: beams and detector system,  
 INST 9 (2014) P06005, [arXiv:1401.4699](https://arxiv.org/abs/1401.4699)

# NA61/SHINE - SPS Heavy Ion and Neutrino Experiment beyond 2020



## Motivation

NA61/SHINE experiment is planning to perform:

- measurements of charm hadron production in Pb+Pb collisions for heavy ion physics,
- measurements of nuclear fragmentation cross section for cosmic ray physics,
- measurements of hadron production induced by proton, kaon and pion beams for neutrino physics.

For this goals an upgrade is needed to:

- Increase data taking rate from about 80 Hz to 1000 Hz
- Improve acceptance and efficiency in Vertex Detector,
- Improve radiation tolerance of PSD detector,
- replace old and deteriorated detectors based on CAMAC and FASTBUS technology (BPD, Trigger detector, ToF).

More information in Addendum to the NA61/SHINE Proposal SPSC-P-330:  
[SPSC-P-330-ADD-10](#)

## Planned upgrades:

Construction of Vertex Detector (VD)  
for  $D^0$ ,  $\bar{D}^0$  decay reconstruction

Replacement of the TPC  
read-out electronics  
to increase data rate to 1 kHz

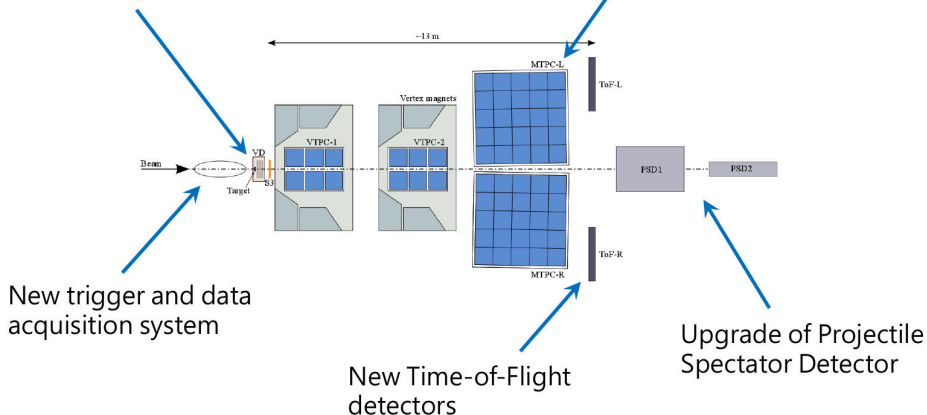

## TPC readout upgrade:

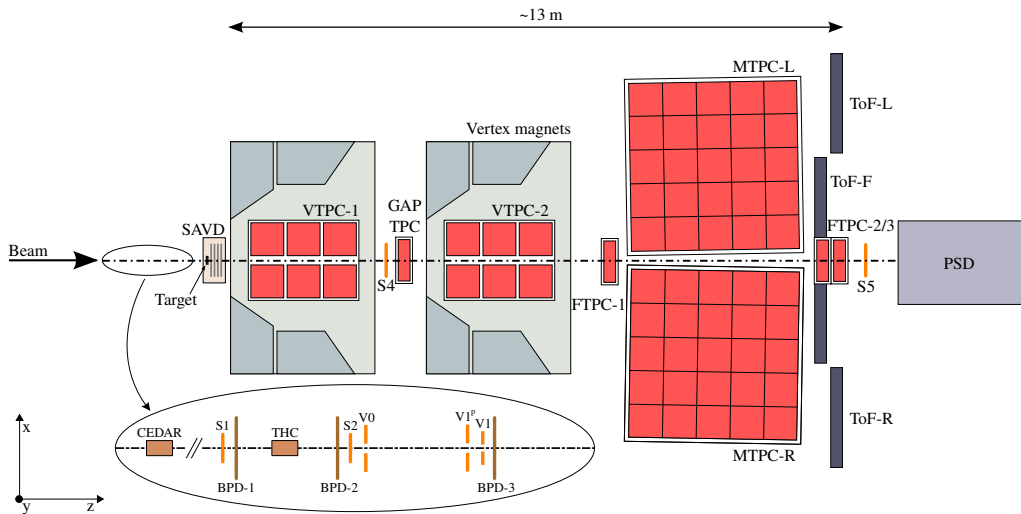

## TPC readout

- Adaptation of ALICE readout system to NA61/SHINE experiment. Different geometry of TPC chambers, connectors, pcb sizes, adaptation of power supply distribution.

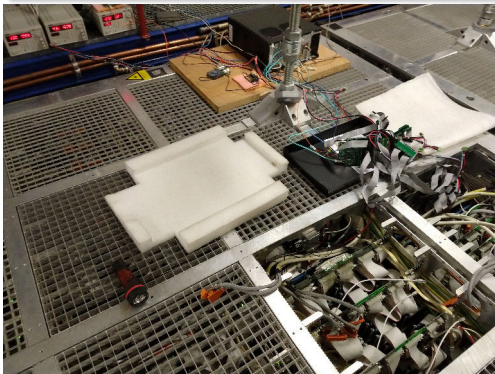

Test of ALICE electronics readout in MTPC-R HR sector of NA61/SHINE experiment

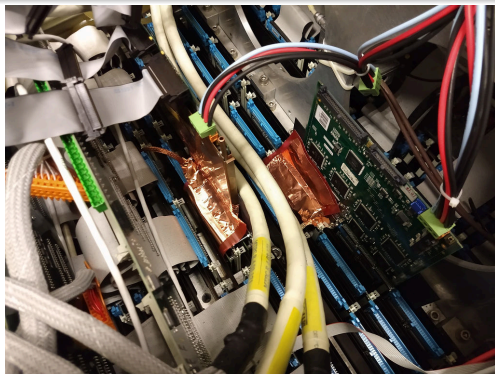

ALICE front-end card connected through temporary adapter board to MTPC chamber pads connector

**Successful tests proved compatibility of NA61/SHINE TPCs with ALICE readout electronics.**

## Vertex Detector upgrade:

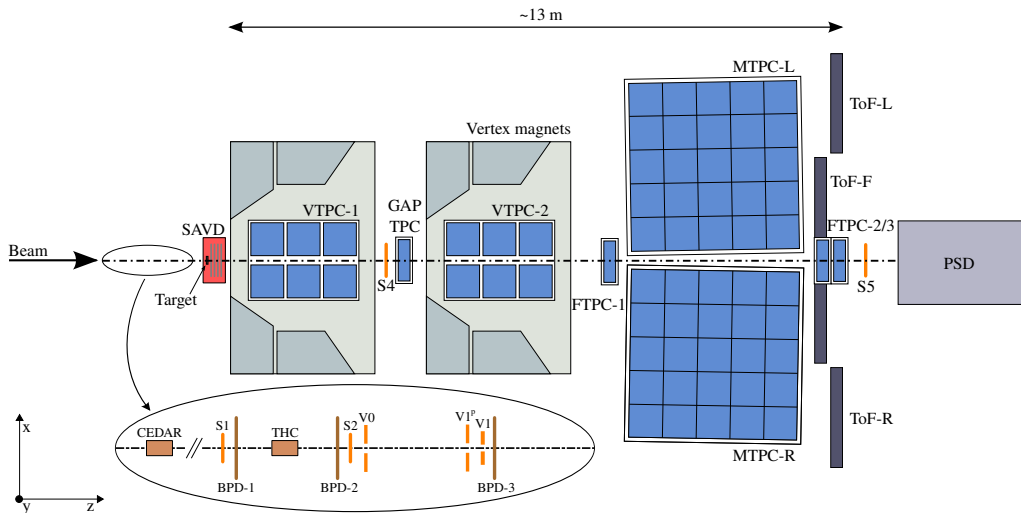



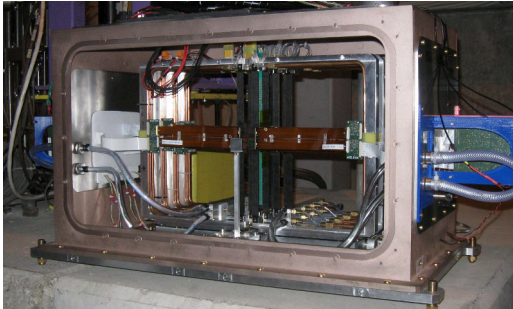

SAVD photo with MIMOSA-26 sensors and test ALPIDE ladder inserted

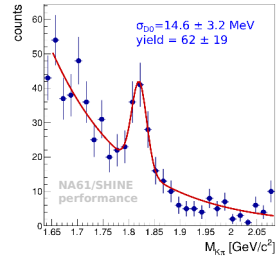

Invariant mass distribution of unlike charge sign  $\pi, K$  decay track candidates for (2016) Pb+Pb collisions at 150A GeV/c.

Upgrade:

- Exchange of Mimosa-26 pixel detectors with ALPIDE detectors to increase readout rate.
- Enlargement of acceptance.
- Exchange of readout electronics and power supply system.

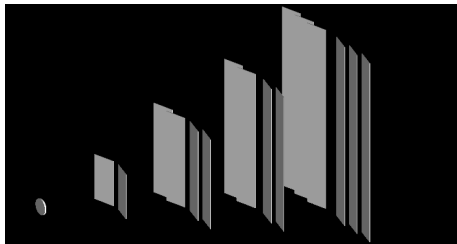

Geometry in Geant4 for simulation of new Vertex Detector

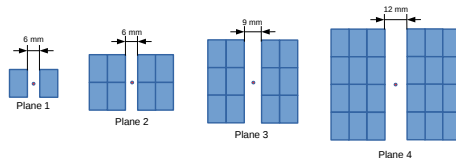

Sensor location in new Vertex Detector

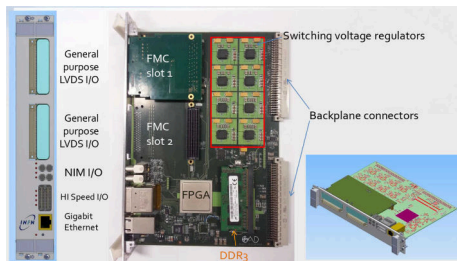

Mosaic readout board

Readout based on MOSAIC (MOdular System for Acquisition Interface Control) boards which were tested on ALICE test-bench system and performed well. **Design finalized.** Detector under construction.

## TDAQ and DCS upgrade:

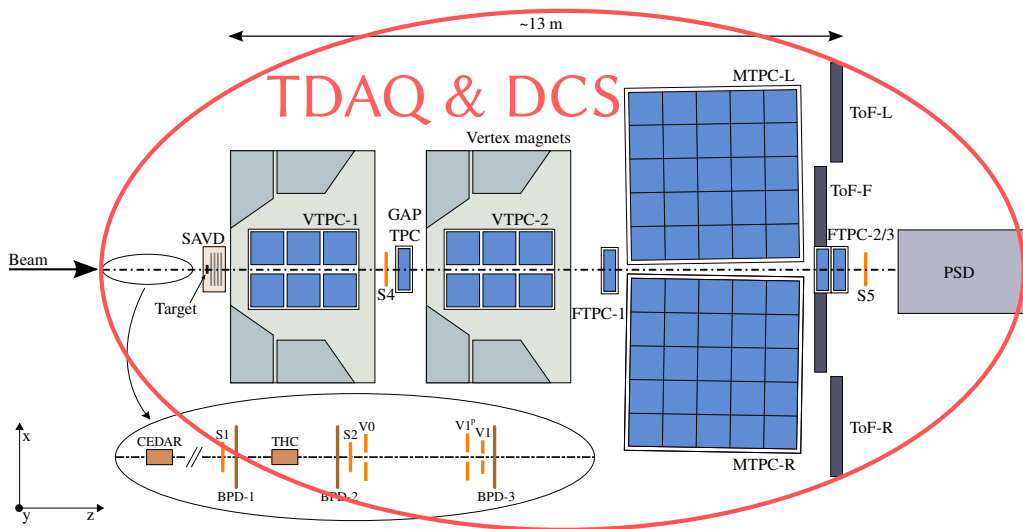

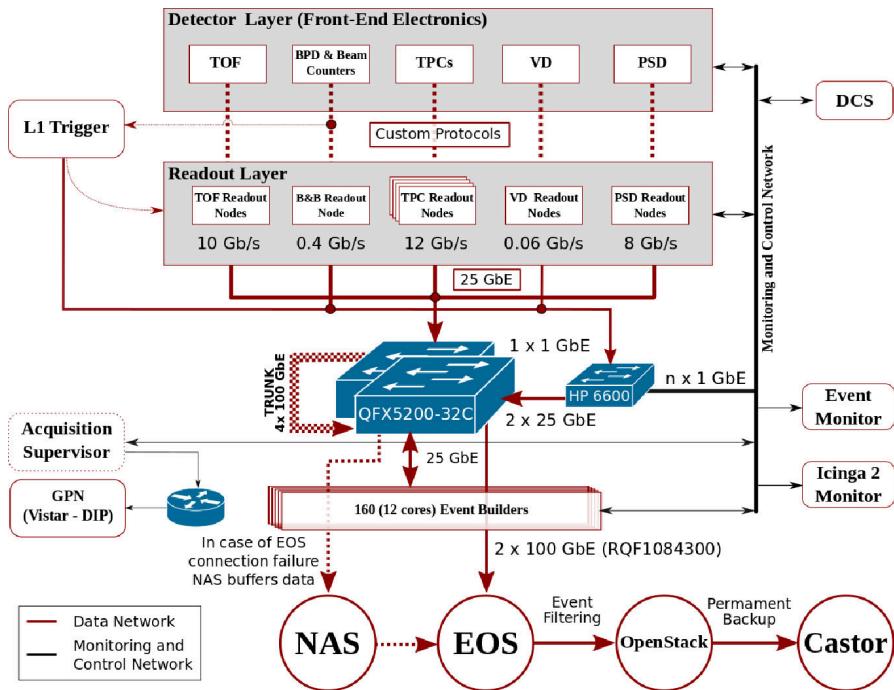

## DAQ design

## Trigger upgrade

- Upgrade of Core Trigger Unit.
- Upgrade of Beam Position Detectors (in design phase).
- Upgrade of Trigger detectors (in design phase).
- Data acquisition based on custom designed DRS4 boards.

Robust and common technology as CAEN V2495 VME unit was chosen for the upgrade of Core Trigger Unit.

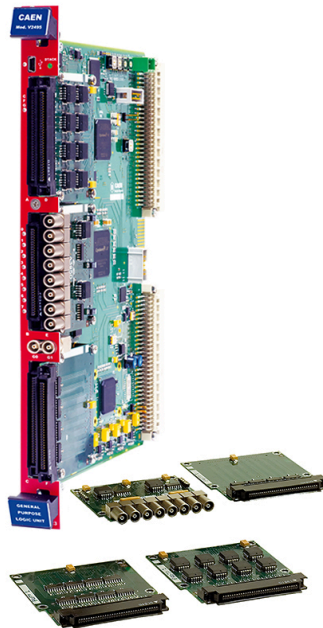

FPGA based trigger unit for trigger upgrade

## Projectile Spectator Detector upgrade:

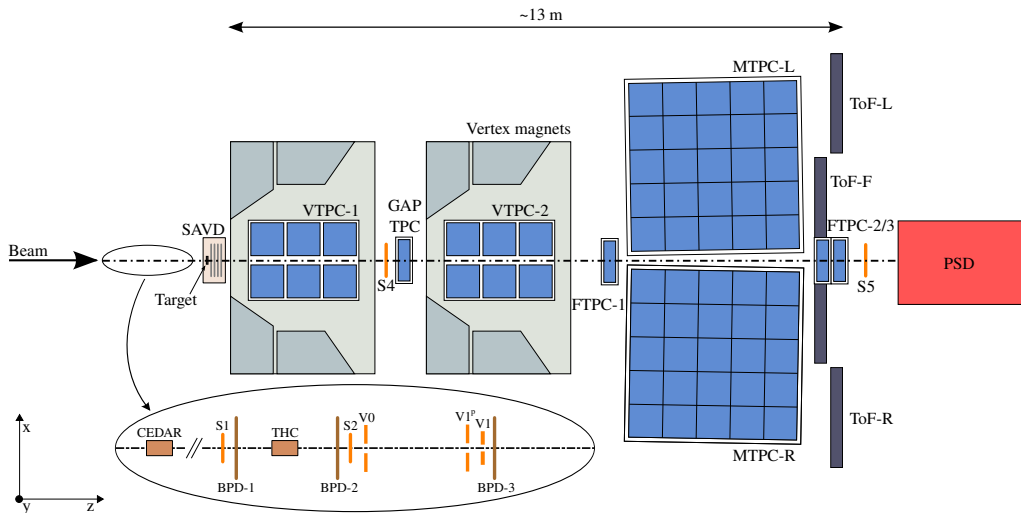



New Projectile Spectator Detector system

**Projectile Spectator Detector is replaced by MPSD and FPSD.**

### PSD calorimeter upgrade

- Installation of Forward-PSD (9 modules)
- Installation of new 4 central modules (hole for the beam) in MPSD.
- Upgrade of front-end electronics
- New fast Hamamatsu MPPCs
- New DRS4 read-out electronics
- New shielding for radiation protection

## Time of Flight detectors upgrade:

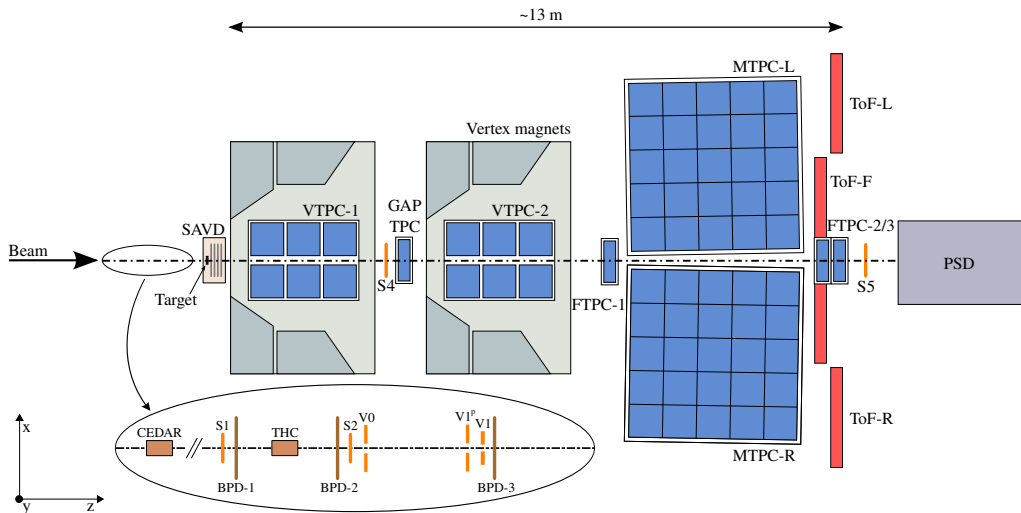



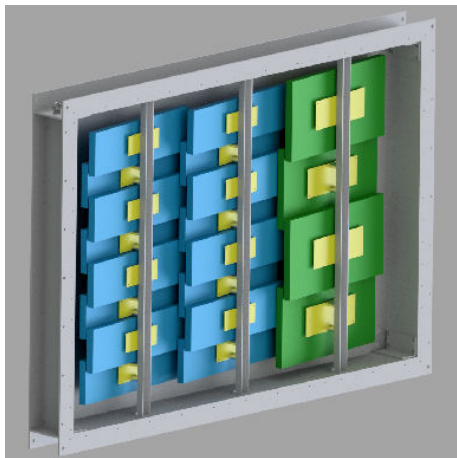

ToF-L wall design

## Multi-gap Resistive Plate Chambers based on JINR MPD/BM@N development

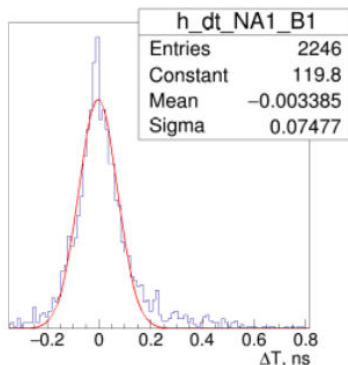

Time resolution  $\sqrt{75^2 - 58^2} \approx 47.5$  ps  
from tests within NA61/SHINE

For readout multiple DRS4 boards with USB3.0 interfaces are considered the best solution. Digitizing whole waveform is superior to Time over Threshold techniques.

## Summary

- Upgrade of NA61/SHINE facility is progressing on schedule.
- Data taking with upgraded detector system is planned to start in 2021.
- Performed tests have shown that ALICE electronics works well with NA61/SHINE TPCs.
- New Vertex Detector will be built based on ALPIDE sensors (at least 1kHz readout rate, high signal to noise ratio).
- Performed tests shown that DRS4 boards are versatile waveform recording boards suitable for data taking from PSD, Trigger and Time of Flight detectors.
- New modular TDAQ system is planned.
- New MRPC detectors were tested and requested time resolution was reached. Construction of new TOF is on the way.

## Acknowledgements

NA61/SHINE upgrade is backed on synergies with ALICE, CBM and MPD/BM@N. Thanks to them for the excellent collaboration and help!



End



Thank you for your attention

# Backup

# Backup

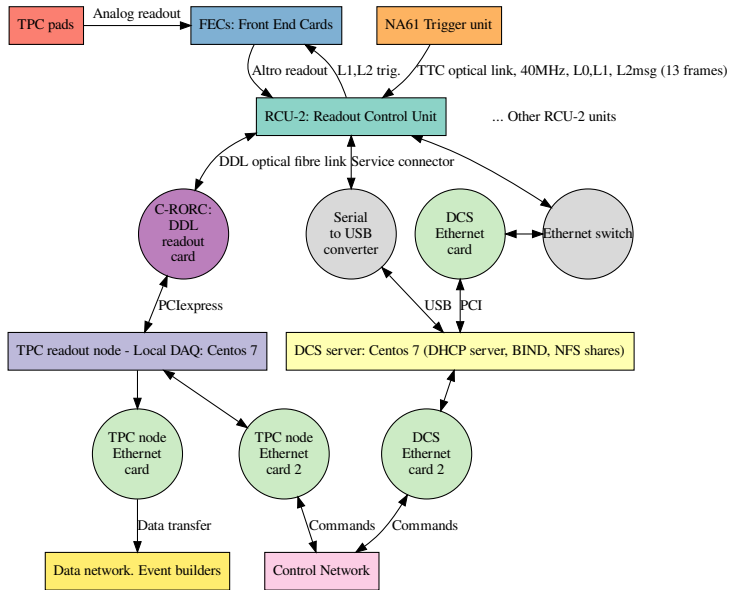

NA61/SHINE TPC readout block diagram

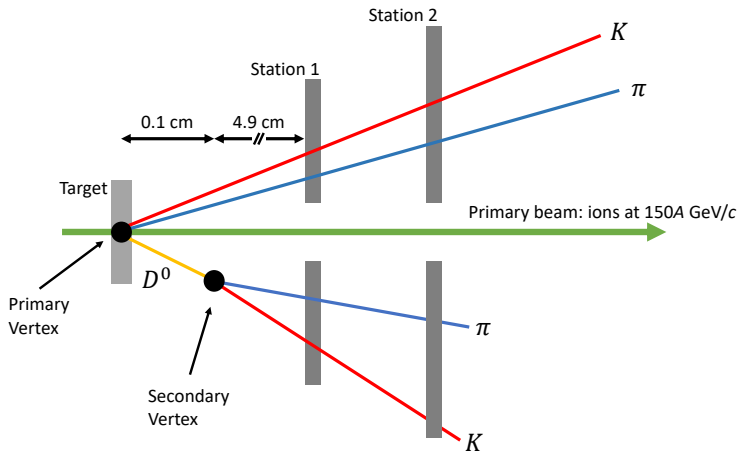

Vertex Detector - an idea of  $D^0$  decay detection

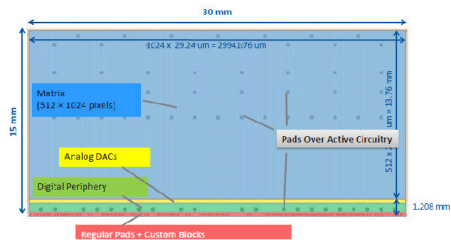
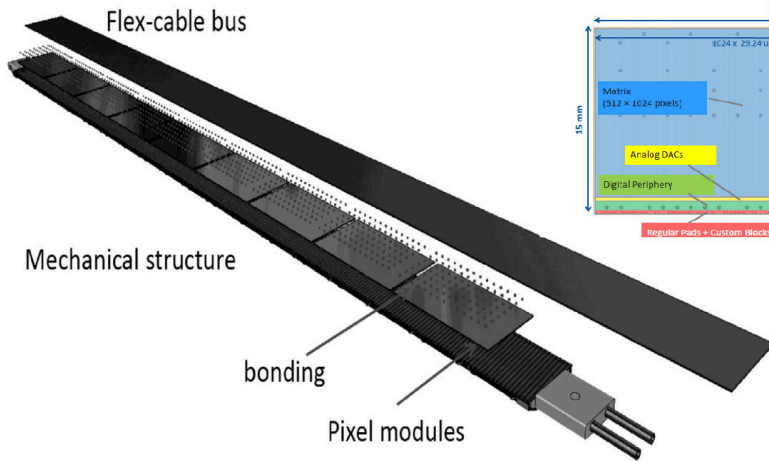

ALPIDE chip

## ALPIDE sensor and stave design

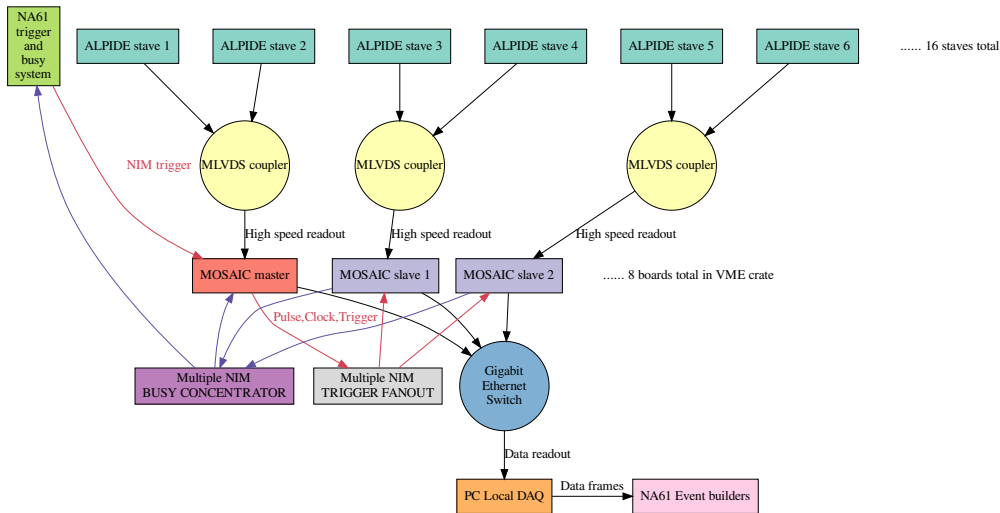

Vertex Detector ALPIDE sensor readout, trigger and busy logic block diagram