



MQXFAP1b TEST RESULTS

Joseph F Muratore – Brookhaven National Laboratory

9th HL-LHC Collaboration Meeting Fermilab 14-16 October 2019



Outline

- Magnet and Test Parameters
- Test Procedures and Operations
- Quench Test Results
- Quench Antenna Data
- Strain Gauge Data
- Lessons Learned from Test Results and Mitigations
- Summary and Conclusions

MQXFAP1/MQXFAP1b DESIGN

MQXFAP1/MQXFAP1b DESIGN AND TEST PARAMETERS

| Parameter | Value |
|---|----------------------------------|
| Coil inner aperture: | 150 mm |
| Coil magnetic length: | 4.0 m (MQXFAP1/MQXFAP1b only) |
| Total length with end plates: | 5 m (nom) |
| Operational temperature and pressure: | 1.9 K and 1 bar |
| LHC nominal operating current I_{nom} (1.9 K): | 16.470 kA |
| LHC ultimate operating current I_{ult} (1.9 K): | 17.890 kA |
| Conductor limit at 1.9 K: | 21.600 kA |
| Conductor limit at 4.5 K: | 19.550 kA |
| Nominal ramp rate: | 20 A/s |
| Field gradient at I_{nom} : | 132.6 T/m |
| Magnet inductance (1.9 K, 1 kA): | 40.9 mH |
| Magnet inductance (1.9 K, I_{nom}): | 32.8 mH |
| Nominal stored energy at I_{nom} : | 4.5 MJ |
| Ultimate stored energy at I_{ult} : | 5.31 MJ |
| Maximum allowed temperature at quench: | 250 K (27 MILts) |
| Maximum allowed voltage across magnet: | 1000 V |
| Dump resistor (energy extraction) options: | 30, 37.5, 50, 75, 150 m Ω |
| Data sampling rate: | 10 – 100 MHz |

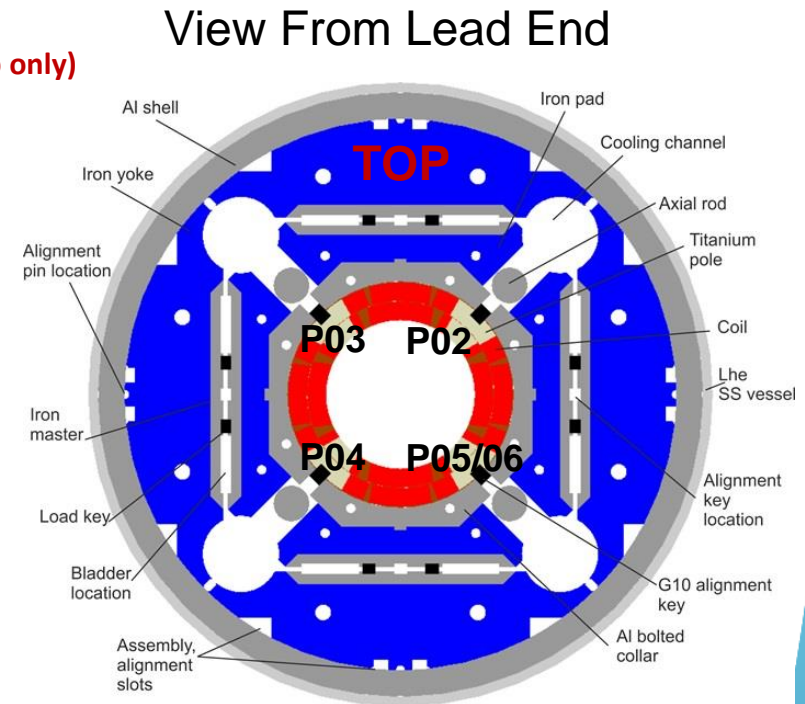

MQXFAP1/MQXFAP1b has shorter coils (4.0 m instead of 4.2 m magnetic length): but same cross-section and structure/yoke length (4.56 m) as all other MQXFA quadrupoles.

BNL VERTICAL TEST FACILITY

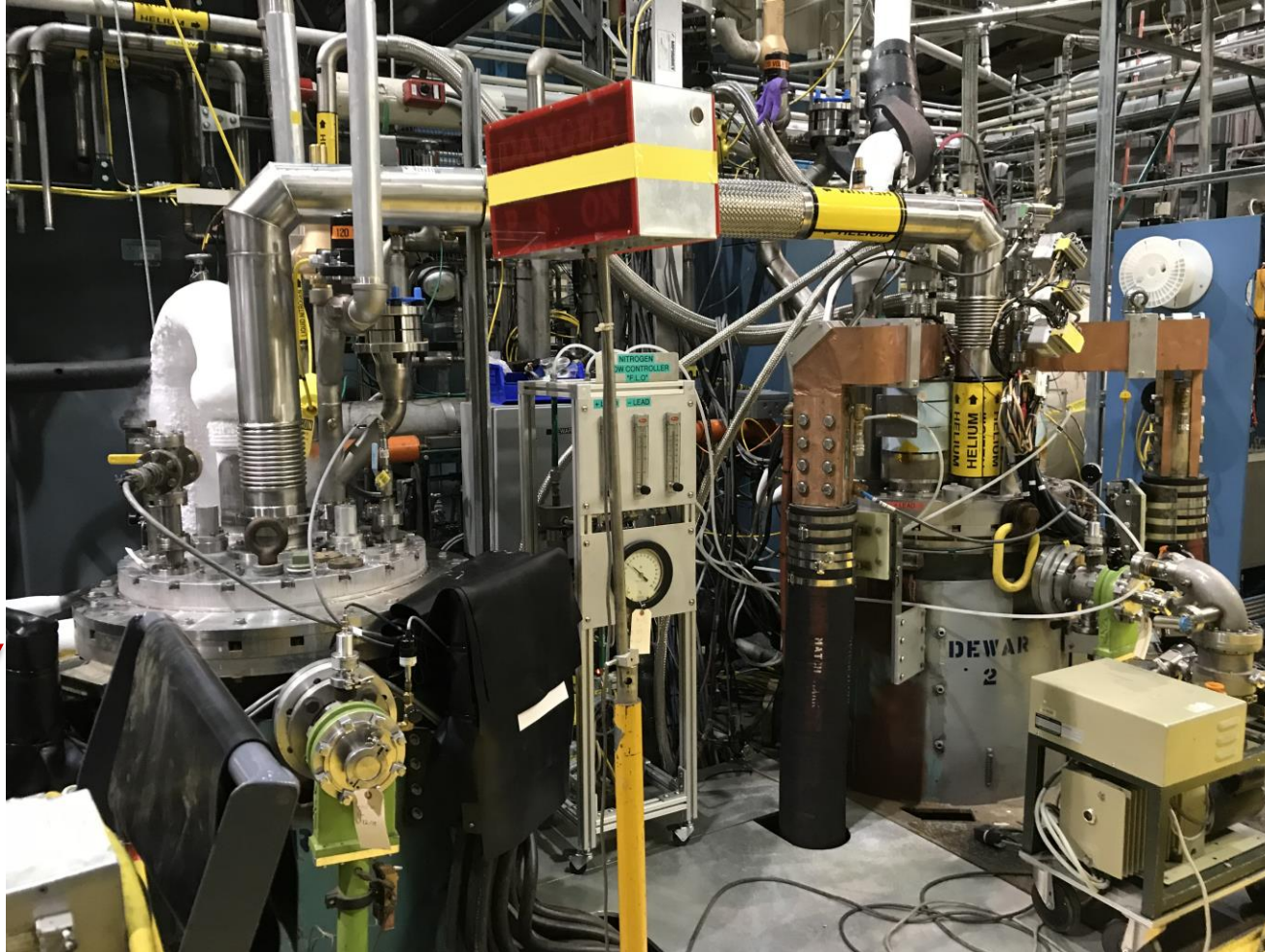

He recovery cold buffer tank

TEST CRYOSTAT

Vertical Test Facility at BNL. The picture shows the test stand with MQXFAP2 being tested. Blue arrow points to **Vertical Test Cryostat 2 (1.9K and 24kA)**. Red arrow points to **Test Cryostat 3**, which is being used as a cold buffer tank for the He return during quench tests.

MQXFAP1b TEST INSTRUMENTATION

- Voltage taps – main (fixed) taps for quench detection and auxiliary (configurable) taps for quench location.
- Strain gauges – two independent systems (Vishay and HBM) installed on coil poles, shells, and axial rods.
- Quench antenna with 16 elements each having two sets of windings.
- Rotating coil magnetic field measuring probe with 220 mm, 110 mm length windings.
- Temperature, LHe level, and pressure measurement systems.

MQXFA Voltage Tap configuration as used at BNL, FNAL, LBNL, and CERN.

All quenches were localized to the best capability of the instrumented voltage taps.

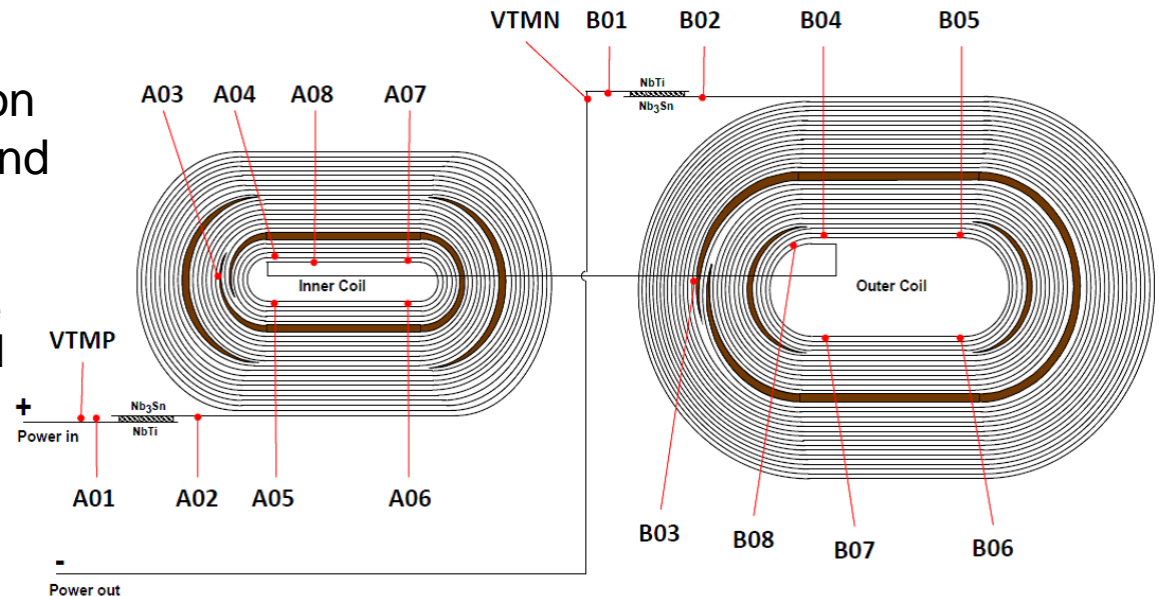

MQXFA QUENCH PROTECTION SYSTEMS

Quench protection is provided by:

- **Coupling Loss Induced Quench (CLIQ)** system. 500 V, 40 mF
- **Energy extraction (EE)** system has range of 30 – 150 m Ω with adjustable delays 0 – 1000 ms. 37.5 m Ω with 10 ms delay
- **Quench protection heaters (QPH)** – 12 heater firing units available if needed; firing units provide same integrated surface power as used in LHC. **Starting with last 4 quenches of MQXFAP1, inner heaters were no longer used.**

The three quench protection systems have capability of independent delays for special test requirements, and quench protection studies (prototypes only).

Power Supply System with Energy Extraction

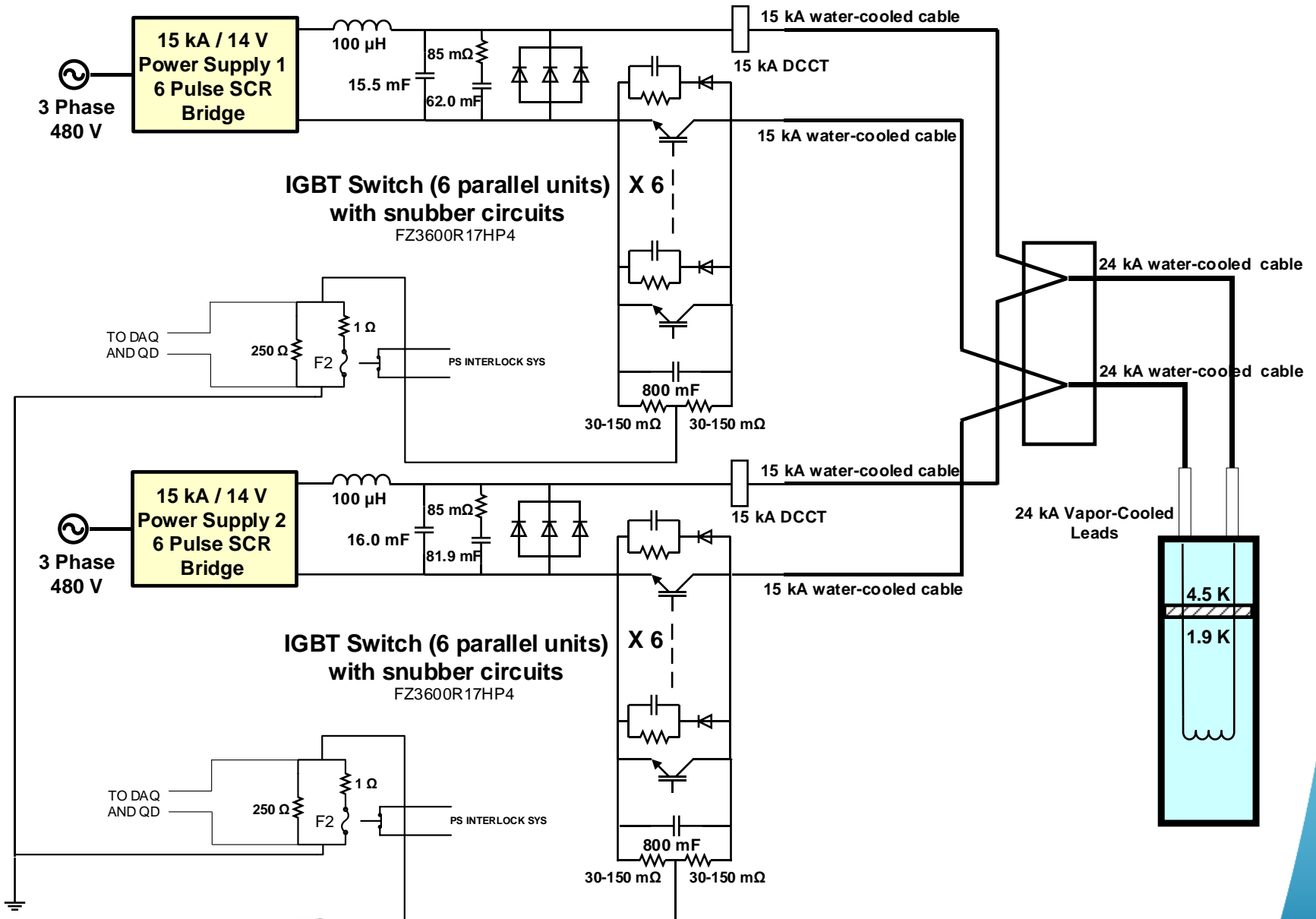

Quench Detector System

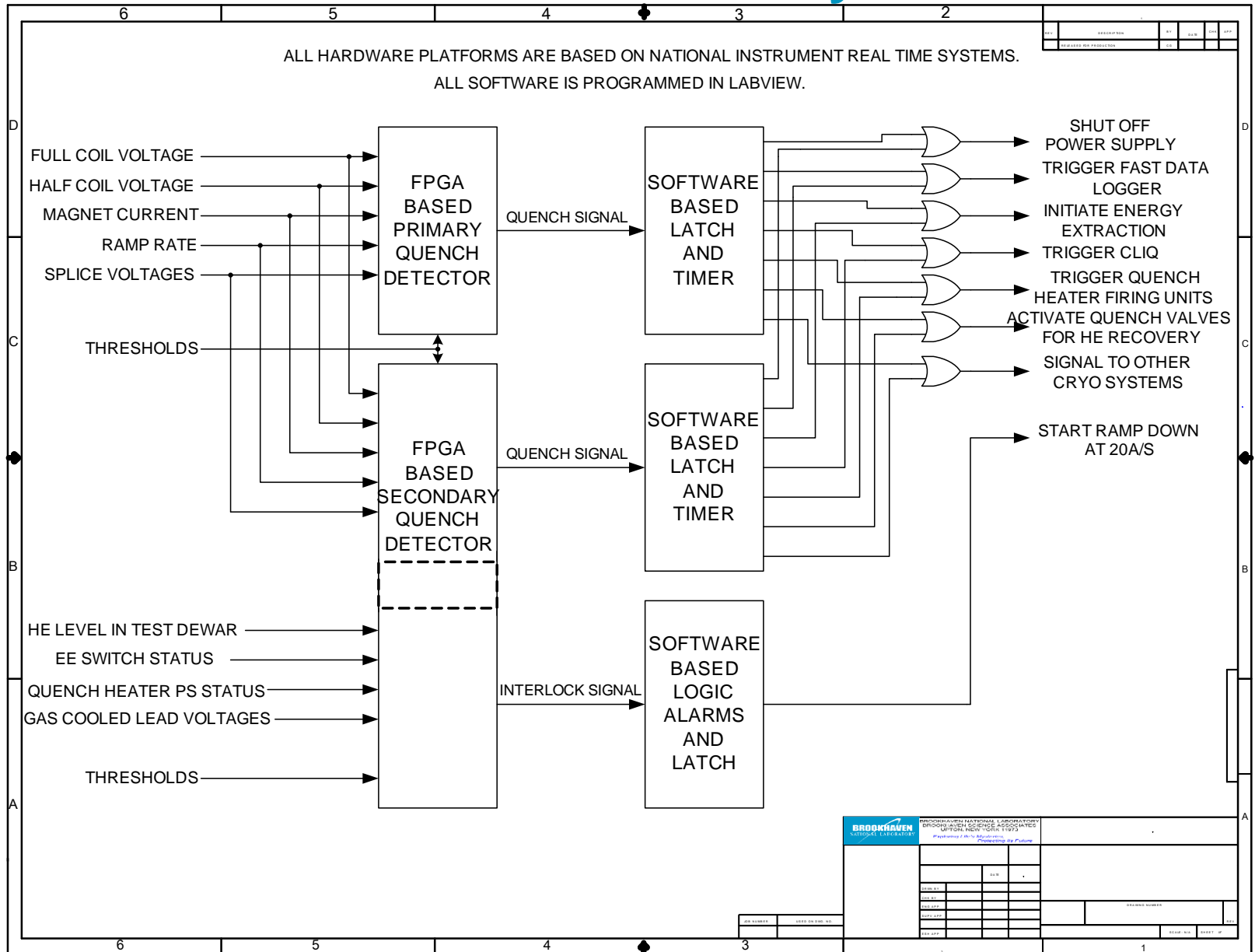

MQXFA TEST PARAMETERS

For the tests of MQXFAP1, MQXFAP2, and MQXFAP1b, the following values were used:

- Operation at 1.9 K superfluid and 1 bar (4.5 K for electrical checkout and temperature dependence assessment).
- Cooldown and warmup with temperature gradient ≤ 100 K (this will be decreased for future tests)
 - Cooldown to 100 K using LN₂ heat exchanger;
 - Cooldown to 4.5 K with LHe;
 - Cooldown to 1.9 K with LHe heat exchanger + 150 W, 2.7 g/s vacuum pump.
- Nominal ramp rate 20 A/s for quench training; other ramp rates were used as needed (e.g. ramp rate studies).
- 100 kHz sampling rate for DAQ; other sampling rates used when needed, e.g. 10 kHz for low current strip heater quenches (≤ 6000 A)

MQXFA TEST PARAMETERS

For the tests of MQXFAP1, MQXFAP2, and MQXFAP1b, the following values were used:

- QD voltage threshold and validation time are functions of current to avoid QD trips due to flux jump spikes below 8000 A.
 - 150 mV and 4 ms for training quenches (≥ 8000 A).
 - Up to 1800 mV and 8 ms during ramps while at lower currents (<8000 A)
- Quench integral value target is 27 MIIts (250 K) for training.
- Energy extraction at 37.5 m Ω (with 10 ms delay for tests of MQXFAP2 and MQXFAP1b).
- CLIQ at 500 V and 40 mF.
- Quench protection heaters at 465 V, 12.4 mF.
- Strain gauge sampling rates of 1 Hz (cooldowns, warmups), 50 Hz (ramps).

MQXFAP1/P1b TEST OPERATIONS

- Room temperature electrical checks with voltage withstand tests (hipots).
- Cooldown to 4.5 K or 1.9 K.
- Cold electrical checks at 4.5 K or 1.9 K with voltage withstand tests (hipots).
- Validation of quench protection heaters with heater quenches, up to 6000 A.
- Quench training program at 1.9 K and 20 A/s.
- Splice joint measurements: <1 n Ω , using Agilent 3458 to slow data logger.
- Ramp rate variations.
- Temperature variations.
- Quench protection studies
- Coil, shell, and axial rod stress measurements as function of temperature and current. Strain gauge reads were done continuously during testing (For stress analysis, see D. Cheng, Thu-Mo-Or16-04, MT-26 paper).
- Magnetic field measurement of harmonics and field angle at room temperature, during cooldown, and at 1.9 K, and again at room temperature.
 - Axial scans (aka z-scans)
 - Current scans (aka DC loops or stair steps)
- (For field measurement analysis, see H. Song, Wed-Af-Po3.20-07, MT-26 paper).

MQXFAP1 History

- First prototype was MQXFAP1.
- MQXFAP1 coils 4.0 m magnetic length, not 4.2 m final design.
- Coils were wound from three different conductors from LARP, and were 1st gen (P02) and 2nd gen design (P03, P04, P05).
- MQXFAP1 was tested at 1.9 K in BNL vertical facility.
- Two thermal cycles, after 1st and 3rd quenches, to upgrade He recovery system to accommodate large energies after quenches.
- Quench currents exhibited memory after thermal cycles.
- Quench training was similar to short prototype training.
- All but 3 out of 18 quenches were in an inner layer pole turn.
- MQXFAP1 test at BNL vertical facility ended Feb 2018 when Coil P05 developed short to ground, which was triggered by a double heater-coil short, caused by hipot at 300 K after first warmup.

MQXFAP1 QUENCH RESULTS

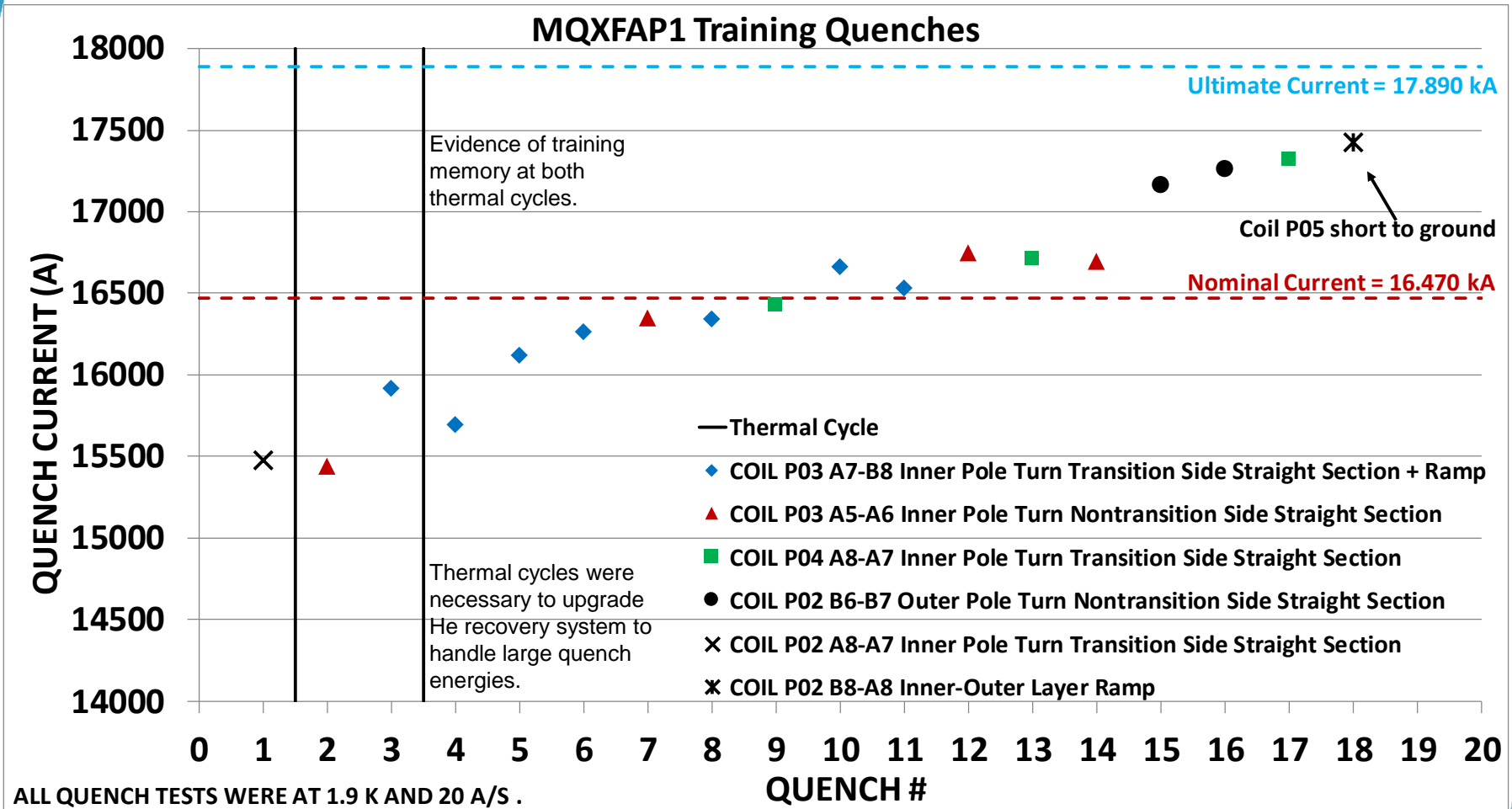

Last five quenches included CLIQ and last four did not use inner strip heaters. Testing ended after 18 training quenches due to development of short to ground.

MQXFAP1 QUENCH RESULTS COMPARED

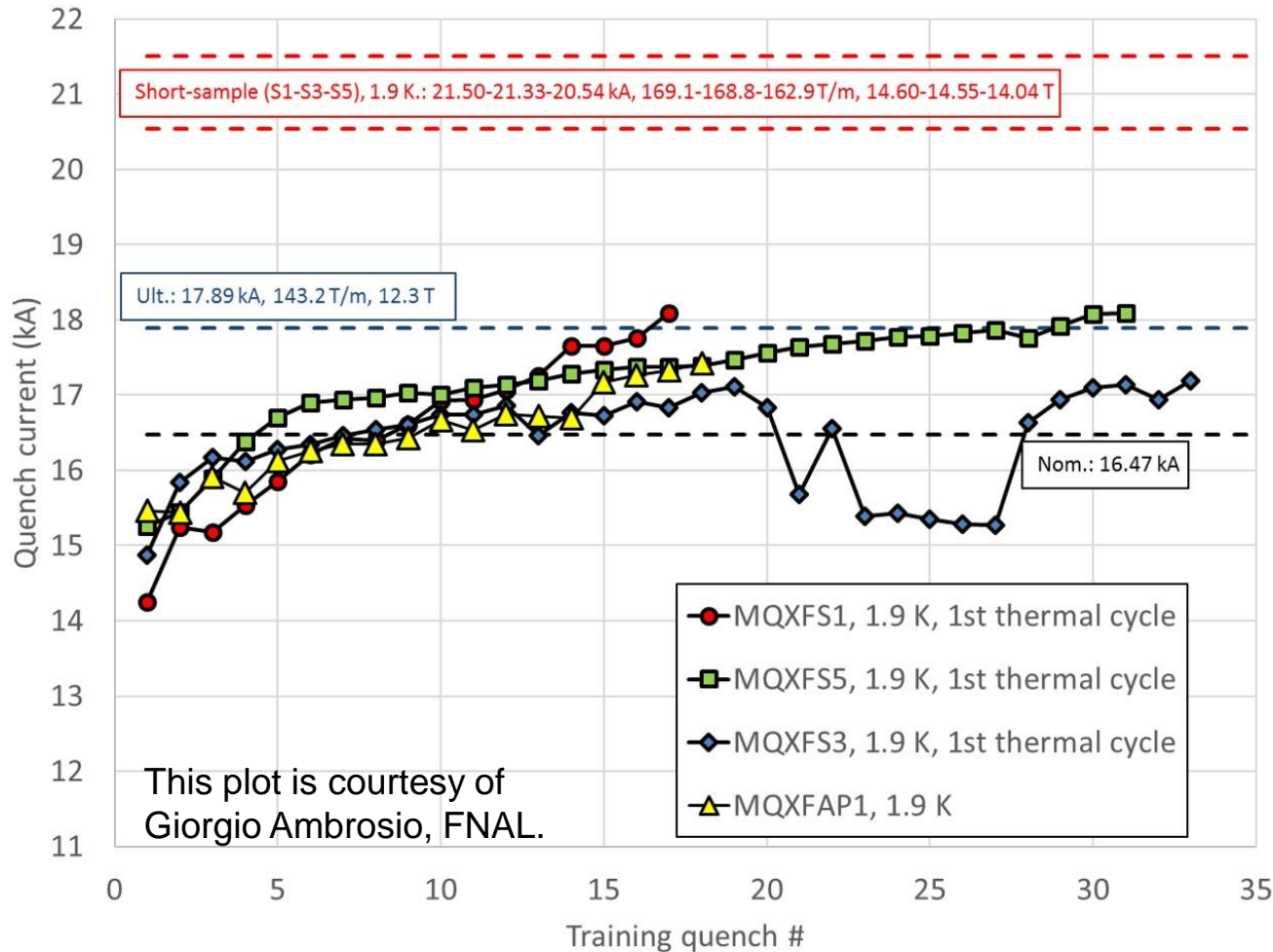

First full-length MQXFA magnet training was similar to short models.

MQXFAP1 QUENCH RESULTS

- Last 5 quenches done with CLIQ added: MIIts decreased from ~29 (~270 K) to ~25 MIIts (220 K), as expected. This was first CLIQ operation with full-length MQXF magnet.
- Last 4 quenches were done without inner layer heaters; MIIts values were not affected. Inner layer heaters are no longer to be used in MQXF magnets.
- Testing ended with Quench 18 when Coil P05 developed a short to ground
 - Hipot tests had been problematic starting with the first cooldown, and at first warmup, where the Coil P05 outer layer - low field strip heater started exhibiting shorts to the coil.
- Coil P05 issue is attributed to a combination of the following causes:
 - Non-conforming impregnation of Coil P05;
 - Hipots done at room temperature after first test at 1.9 K – trapped He gas.
- Coil P05 was subsequently replaced with new 4.0 m coil (P06) for re-test later as MQXFAP1b.

MQXFAP1/MQXFAP1b History

- MQXFAP1 re-built as MQXFAP1b with new 4.0 m Coil P06 replacing P05.
- The previous 4.56 m structure was used with a return end stainless steel spacer to compensate for shorter coils.
- MQXFAP1b was tested at BNL vertical facility May-June 2019.
- There were a total of 37 quenches during training program.

MQXFAP1b QUENCH RESULTS

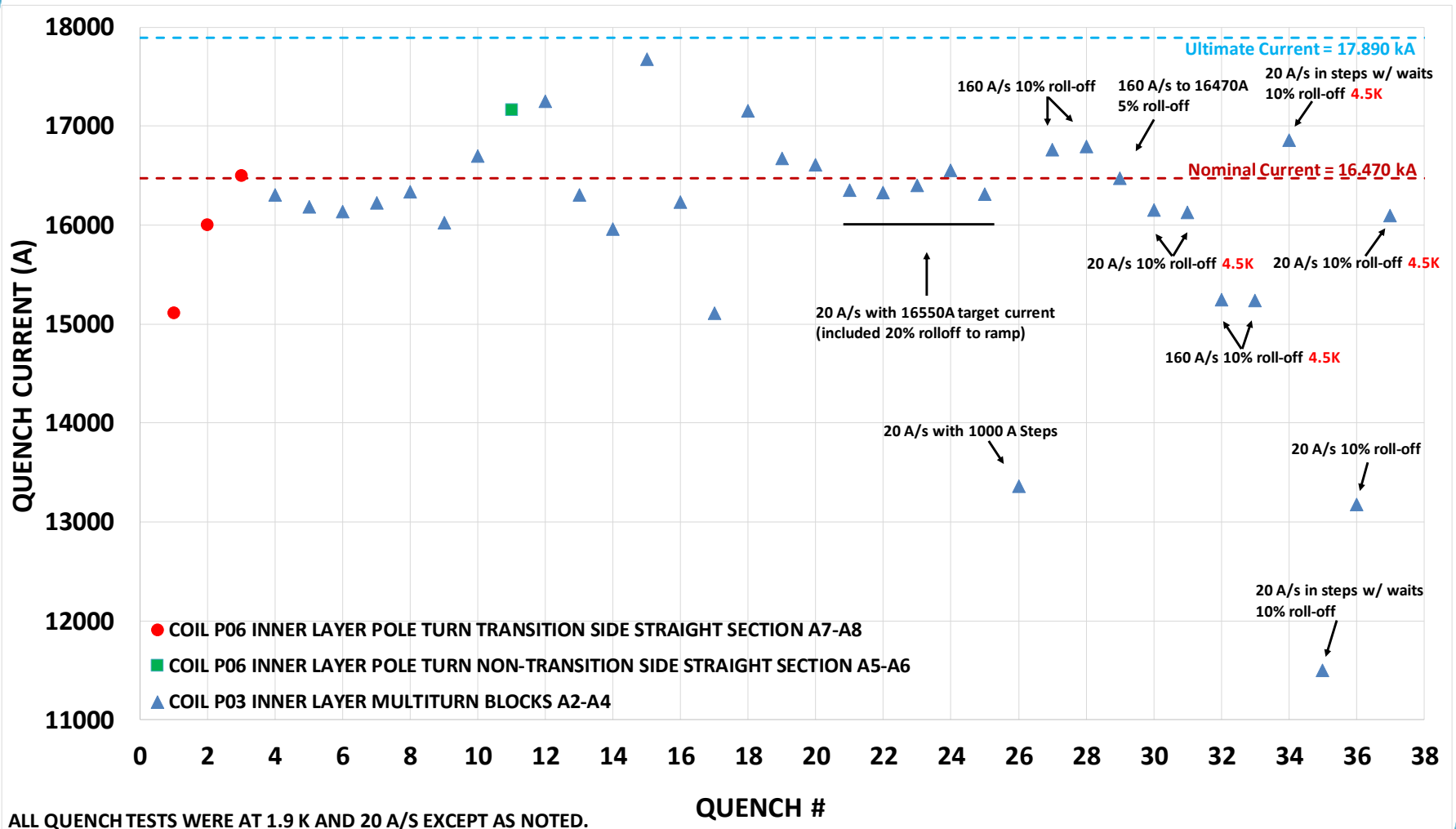

MQXFAP1b QUENCH RESULTS

- First 3 quenches were in the new Coil P06 and trained normally to nominal operating current, and were in the inner layer pole turn. This was as expected for virgin coil.
- Other than one more quench in Coil P06, the rest of the quenches were in Coil P03 inner layer, somewhere in the two multiturn blocks; the tap A3 in P03 was open so the resulting section comprised all the turns other than the pole turn.
- Quench currents 8-18 were highly erratic, implying mechanical issue.
- Starting with Quench 19, quench currents were stable but low, and were affected by both ramp rate and temperature, implying conductor damage.
- MQXFAP1b will be disassembled and Coil P03 will be inspected.
- Epoxy failure is suspected.
- Also, pre-loading sequence (100% Az, 100% Ax) may have contributed to limited performance, and has been changed for future magnets.

MQXFAP1 - MQXFAP1b

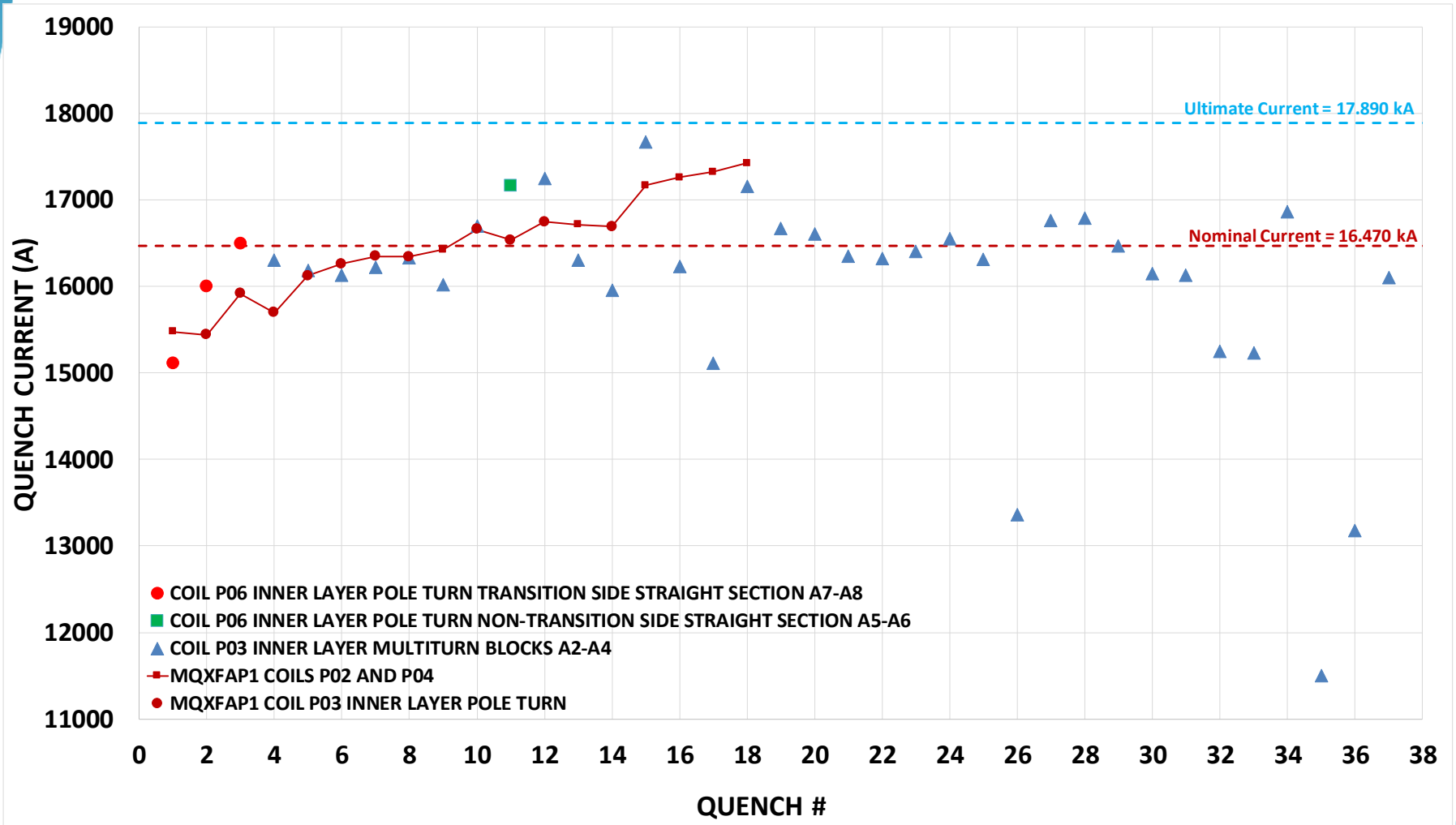

MQXFAP1b QUENCH ANTENNA

- For P03 quenches, voltage tap signals could not locate origins; quench antenna was more useful.
- QA has 16 axially distributed PCB elements: 4 on each end spaced 5.08 cm apart and 8 along straight section spaced 42.7 cm apart. Element numbers ordered 1 (LE) → 16 (RE). 32 signals to DAQ.
- QA signal-to-noise very low and digital bandpass filter 70-700 Hz was used .
- For many quenches the QA results were inconclusive.
- For those quenches with good signals, locations were found at both ends and near middle of magnet.
- Conclusion: Coil P03 quench locations were moving during the training program.

Quench antenna analysis by
M. Marchevsky, LBNL.

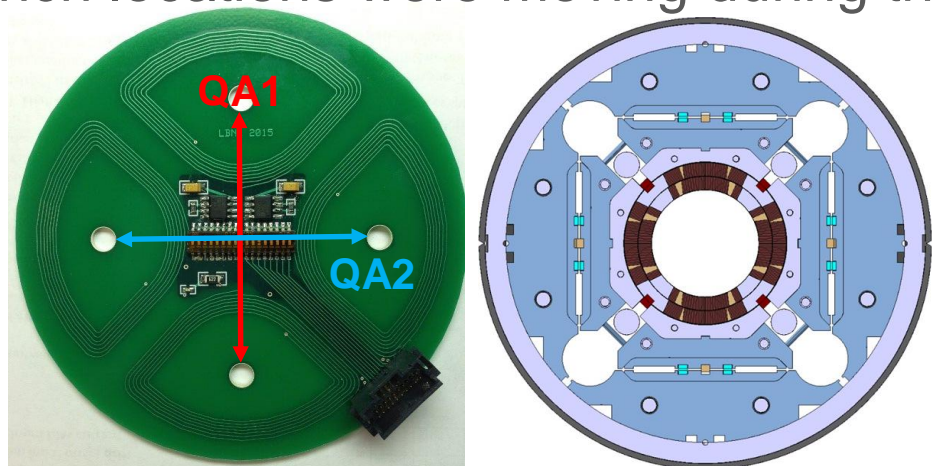

MQXFAP1b QUENCH ANTENNA

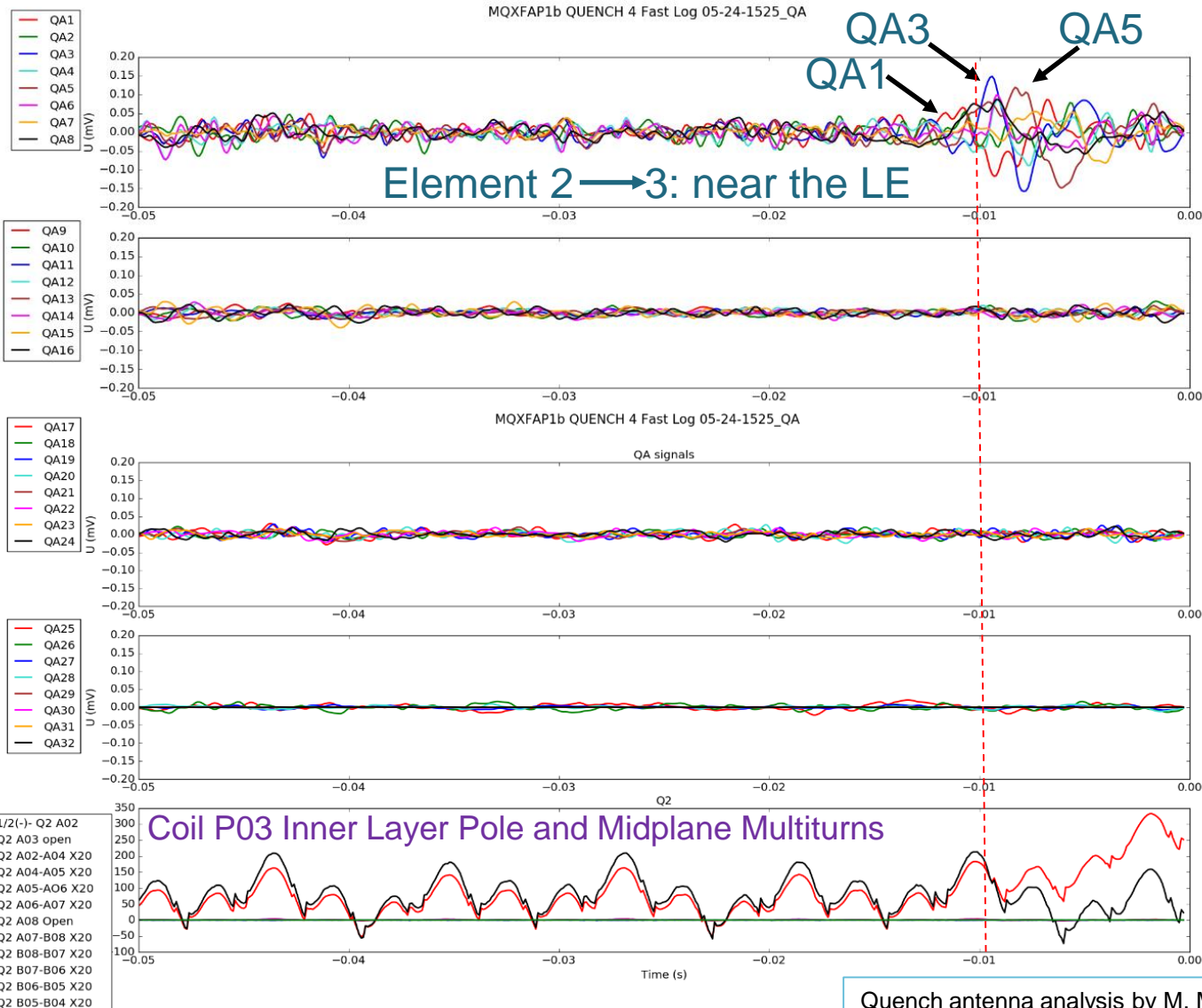

Quench antenna analysis by M. Marchevsky, LBNL.

MQXFAP1b QUENCH ANTENNA

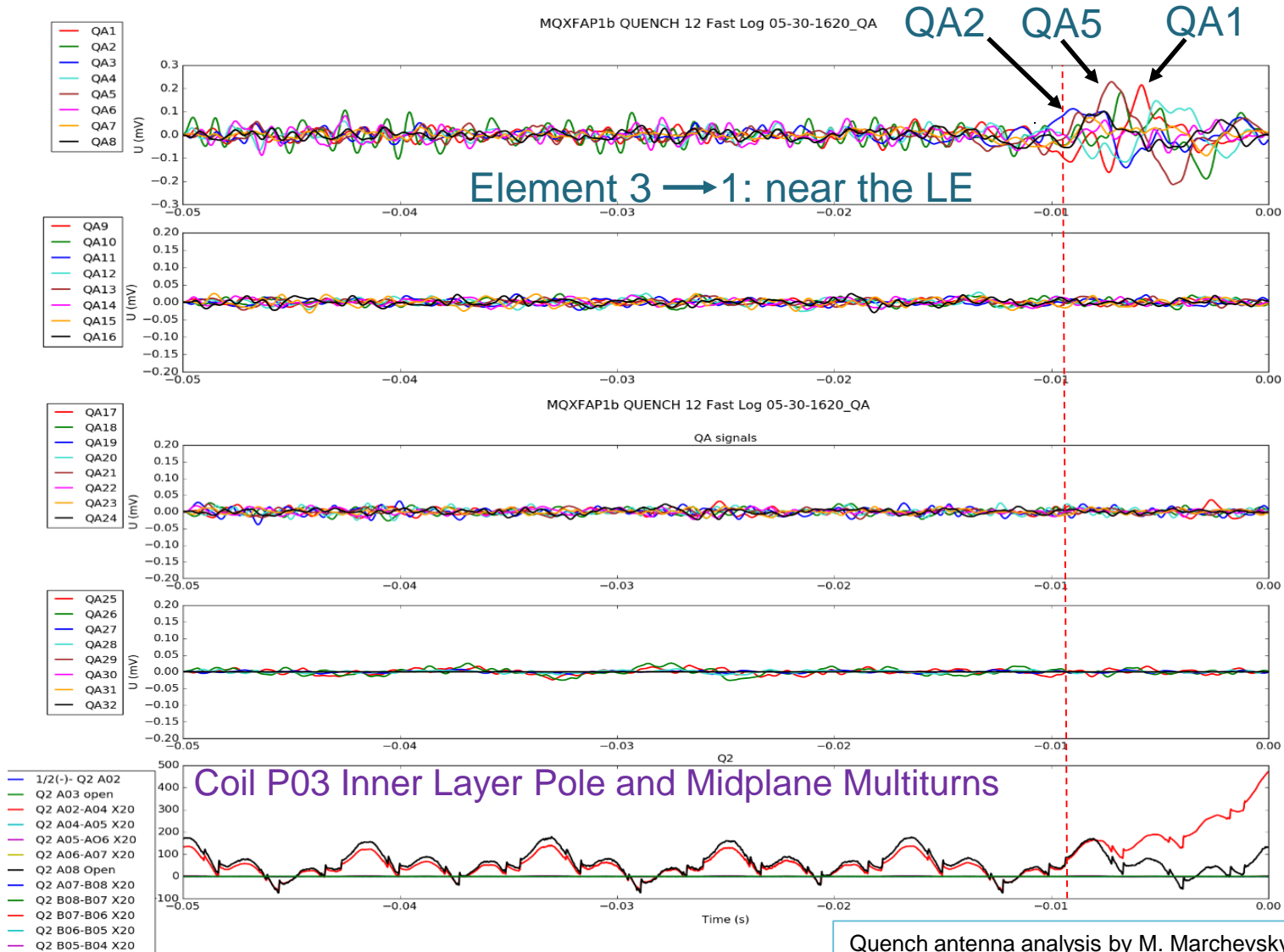

MQXFAP1b QUENCH ANTENNA

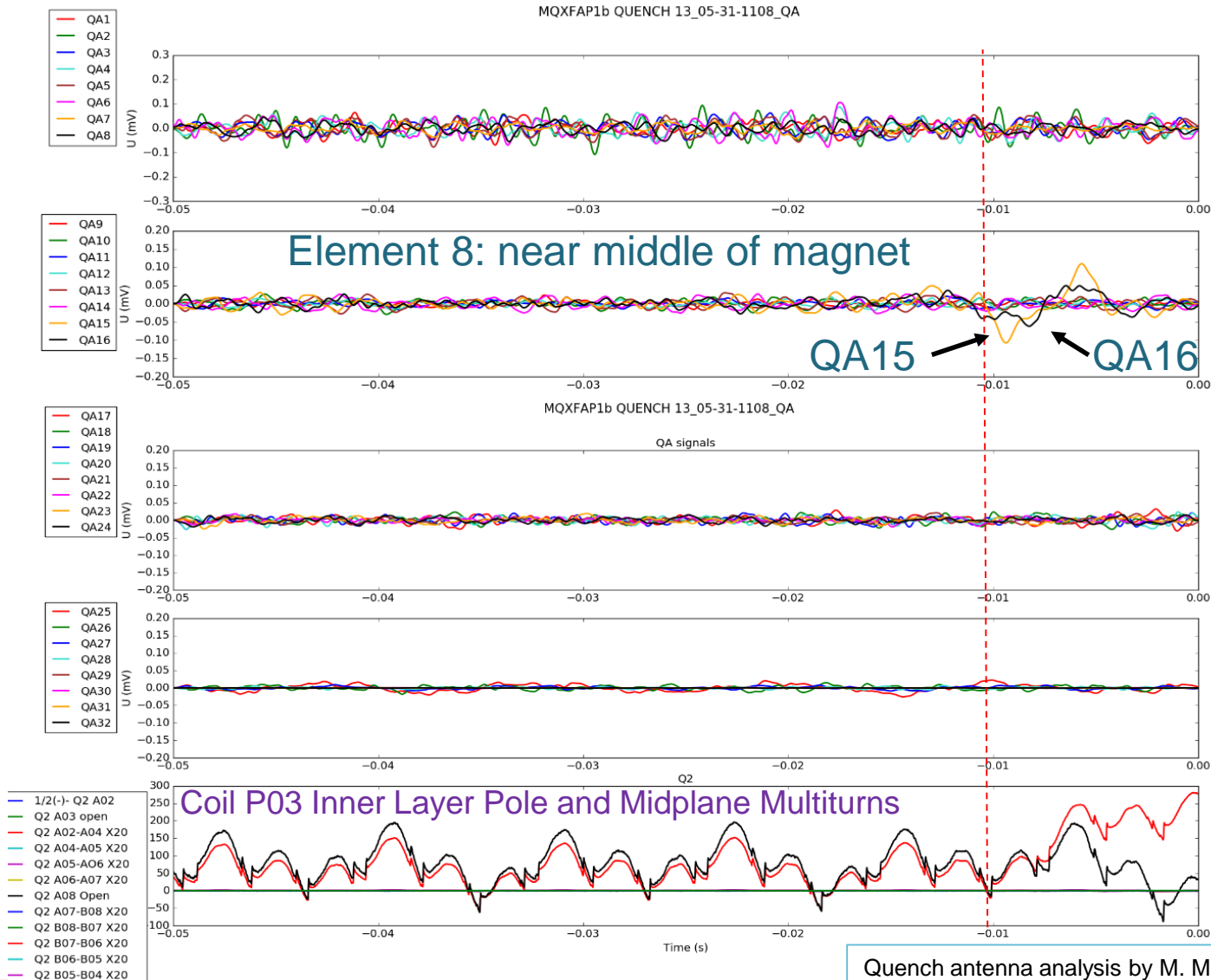

Quench antenna analysis by M. Marchevsky, LBNL.

MQXFAP1b QUENCH ANTENNA

| # | Quench description | QA-based location |
|----|---|-------------------------|
| 1 | IQ = 15111.67 A Coil P06 Inner Pole Turn straight section | ? |
| 2 | IQ = 16003.10 A Coil P06 Inner Pole Turn straight section | ? |
| 3 | IQ = 16500.14 A Coil P06 Inner Pole Turn straight section | ? |
| 4 | IQ= 16308.37 A Coil P03 Inner Pole and Midplane Multiturns | Element 2 -> 3 (LE) |
| 5 | IQ = 16182.85 A Coil P03 Inner Pole and Midplane Multiturns | Element 2 -> 3 (LE) |
| 6 | IQ = 16133.03 A Coil P03 Inner Pole and Midplane Multiturns | Element 2 -> 3 (LE) |
| 7 | IQ = 16223.59 A Coil P03 Inner Pole and Midplane Multiturns | ? Not LE |
| 8 | IQ = 16336.46 A Coil P03 Inner Pole and Midplane Multiturns | ? Not LE |
| 9 | IQ = 16021.07 A Coil P03 Inner Pole and Midplane Multiturns | ? Not LE |
| 10 | IQ = 16698.21 A Coil P03 Inner Pole and Midplane Multiturns | ? Not LE |
| 11 | IQ = 17163.87 A Coil P06 Inner Pole Turn straight section | ? |
| 12 | IQ = 17251.35 A Coil P03 Inner Pole and Midplane Multiturns | Element 3 -> 1 (LE) |
| 13 | IQ = 16304.67 A Coil P03 Inner Pole and Midplane Multiturns | Element 8 |
| 14 | IQ = 15960.27 A Coil P03 Inner Pole and Midplane Multiturns | Element 8 |
| 15 | IQ = 17672.52 A Coil P03 Inner Pole and Midplane Multiturns | Elements 13 and 14 (RE) |
| 16 | IQ = 16234.71 A Coil P03 Inner Pole and Midplane Multiturns | Element 8 |
| 17 | IQ = 15110.15 A Coil P03 Inner Pole and Midplane Multiturns | Element 8 |
| 18 | IQ = 17156.90 A Coil P03 Inner Pole and Midplane Multiturns | Element 13 |

Quench antenna analysis by M. Marchevsky, LBNL.

MQXFAP1b QUENCH ANTENNA

| # | Quench description | QA-based location |
|----|---|--------------------------|
| 19 | IQ = 16674.41 A Coil P03 Inner Pole and Midplane Multiturns | Element 13 |
| 20 | IQ = 16610.33 A Coil P03 Inner Pole and Midplane Multiturns | Element 13 |
| 21 | IQ = 16353.06 A Coil P03 Inner Pole and Midplane Multiturns | Element 13 |
| 22 | IQ = 16326.96 A Coil P03 Inner Pole and Midplane Multiturns | Element 13 |
| 23 | IQ = 16402.49 A Coil P03 Inner Pole and Midplane Multiturns | Element 14 |
| 24 | IQ = 16551.63 A Coil P03 Inner Pole and Midplane Multiturns | Element 14 |
| 25 | IQ = 16311.32 A Coil P03 Inner Pole and Midplane Multiturns | Element 13 |
| 26 | IQ = 13357.22 A Coil P03 Inner Pole and Midplane Multiturns | ? |
| 27 | IQ = 16761.93 A Coil P03 | Element 11 (?) |
| 28 | IQ = 16245 A Coil P03 | ? |
| 29 | IQ = 16470 A Coil P03 | Element 14 -> Element 13 |
| 30 | IQ = 16150.47A Coil P03 | Element 11 |
| 31 | IQ = 16128.20A Coil P03 | Element 11 |
| 32 | IQ = 15248.05A Coil P03 | ? |
| 33 | IQ = 15236.51A Coil P03 | ? |
| 34 | IQ= 16860.62A Coil P03 | Element 11 |

Quench antenna analysis by M. Marchevsky, LBNL.

MQXFAP1/MQXFAP1b STRAIN GAUGES

For details, see D. Cheng, Thu-Mo-Or16-04 MT-26 paper.

Brief Summary:

- MQXFAP1 and MQXFAP1b shell gauge readings matched FEA models, reached their targets: 140 MPa, 125 MPa, respectively.
- Coil gauge readings show unloading for both magnets with P1b showing higher applied preload.
- For P1, rod strains did not agree with FEA frictional/frictionless models; but P1b RE rod gauges matched frictional model; but rod bending may have affected LE gauges.

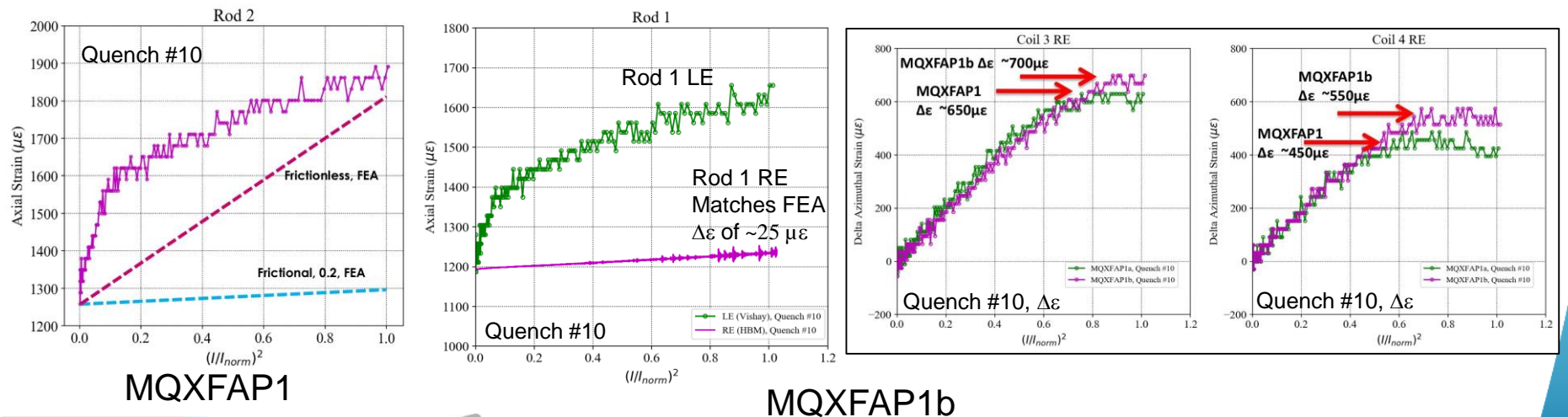

LESSONS LEARNED AND MITIGATIONS

MQXFAP1 Coil P05 failure:

- After initial cold hipots and exposure to He, warm hipot voltages are now reduced to safer levels (factor of 5 less than initial cold).
- Supplier of insulation between heaters and coil has been changed.
- Impregnation process has been upgraded and is still being investigated.
- See V. Marinozzi, Mo-Po1.03-07 MT-26 paper.

MQXFAP2 End Shell failure:

- Shell alignment cut-outs are now to have 10 - 15 mm fillet radius at the corners to minimize stress at those locations.
- Heat treatment of aluminum used in failed shell will no longer be used.
- Pole key gap increased to reduce shell stress.
- See H. Peng, Mon-Mo-Po1.03-02 Mt-26 paper.

MQXFAP1b Coil P03 failure:

- Coil P03 still has not yet been removed from the structure and so is still under investigation.
- Impregnation issue and epoxy failure is suspected. Analysis in progress.
- Azimuthal and axial pre-load order has been changed.
- See D. Cheng, Thu-Mo-Or16-04 MT-26 paper.

SUMMARY

- The last MQXFAP prototype test has completed.
- In each test, there was a specific issue which pointed to an issue which has been addressed or is under investigation. Lessons learned in prototype tests have been applied to pre-series and series magnets, starting with the first pre-series magnet (MQXFA03), to be tested in November.
- MQXFAP1 training and early MQXFAP1b training contributed to validating the long magnet structural design, but some specific issues were uncovered by the testing and these are being addressed before the test of MQXFA03, the first pre-series MQXFA magnet.
- The upgraded BNL test facility was validated and performed successfully. During the course of the testing, various modifications were implemented to increase the efficiency of the test procedures, to accommodate the high quench energies for the He recovery system, and also to help meet the testing requirements of the Hi-Lumi program.
- In particular, for example, the 1.9K heat exchanger capacity (increased surface area) and instrumentation (longer level probes) were improved for the MQXFAP1b test as compared to previous tests, which significantly reduced cooldown time from 4.5K to 1.9K, and resulted in the successful completion of 3 training quenches in 1 test day for several of the testing days.

EXTRA SLIDES



Final Design - BNL Test Facility

Nash "high capacity" vacuum Pump (1.9 K)

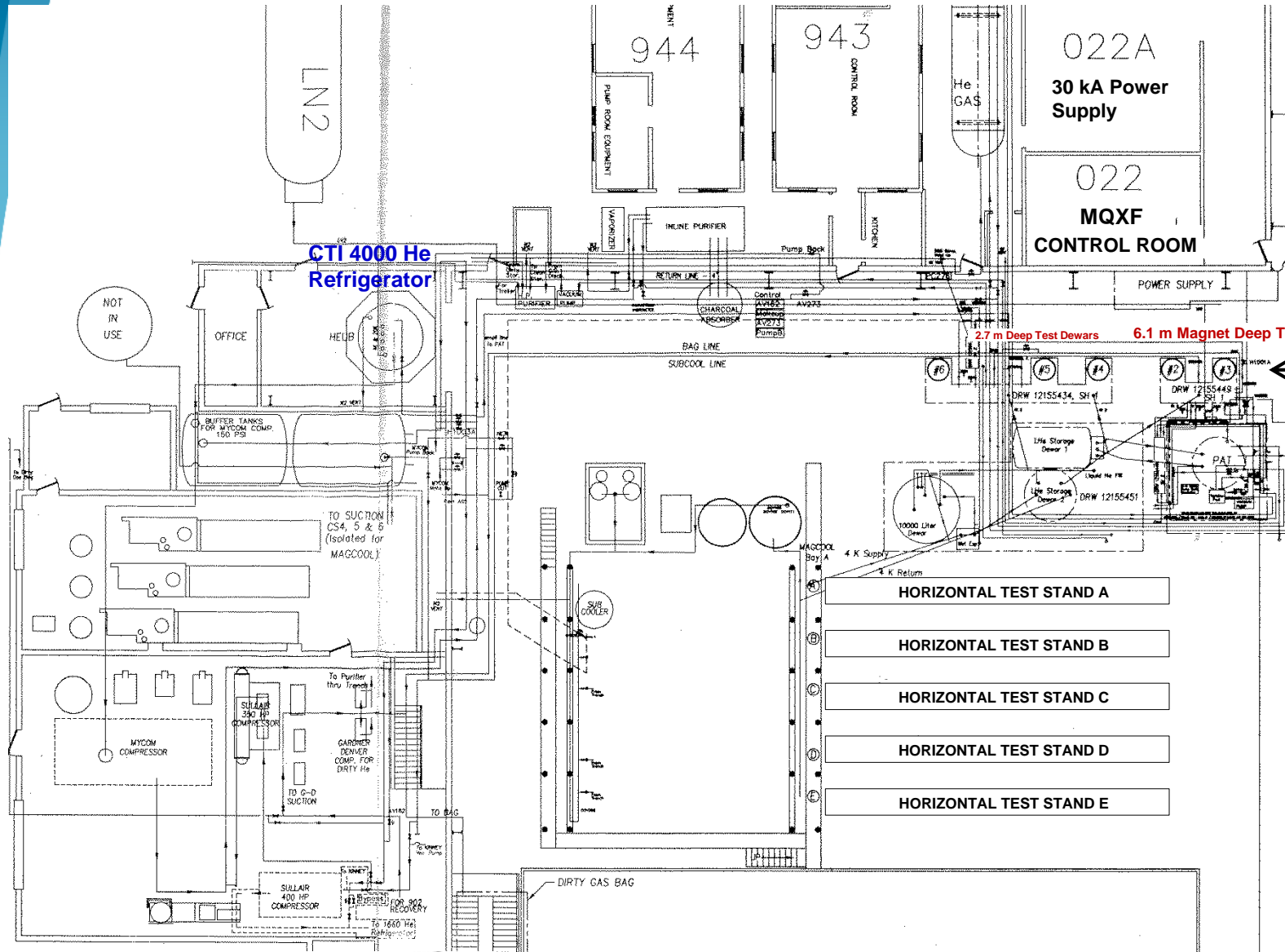

**Building 902
Test Facility
Floor Plan
and
Overview**

**Vertical Test
Dewars 2-6**

- HORIZONTAL TEST STAND A
- HORIZONTAL TEST STAND B
- HORIZONTAL TEST STAND C
- HORIZONTAL TEST STAND D
- HORIZONTAL TEST STAND E



BROOKHAVEN
NATIONAL LABORATORY

Final Design – Cryogenic System

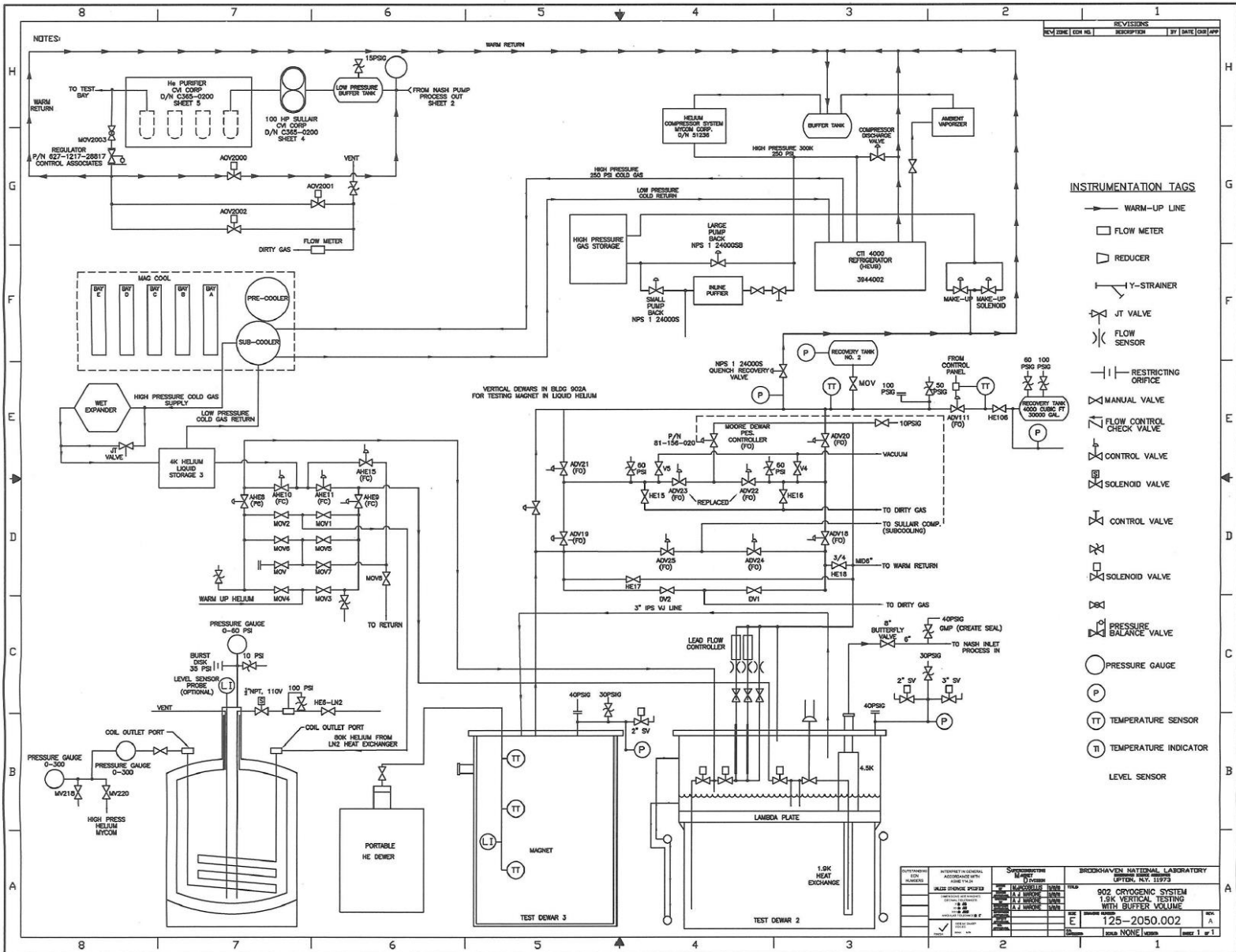

Cryogenic System Upgrades

Helium Flow Schematic Using 2nd Test Cryostat as Cold Buffer

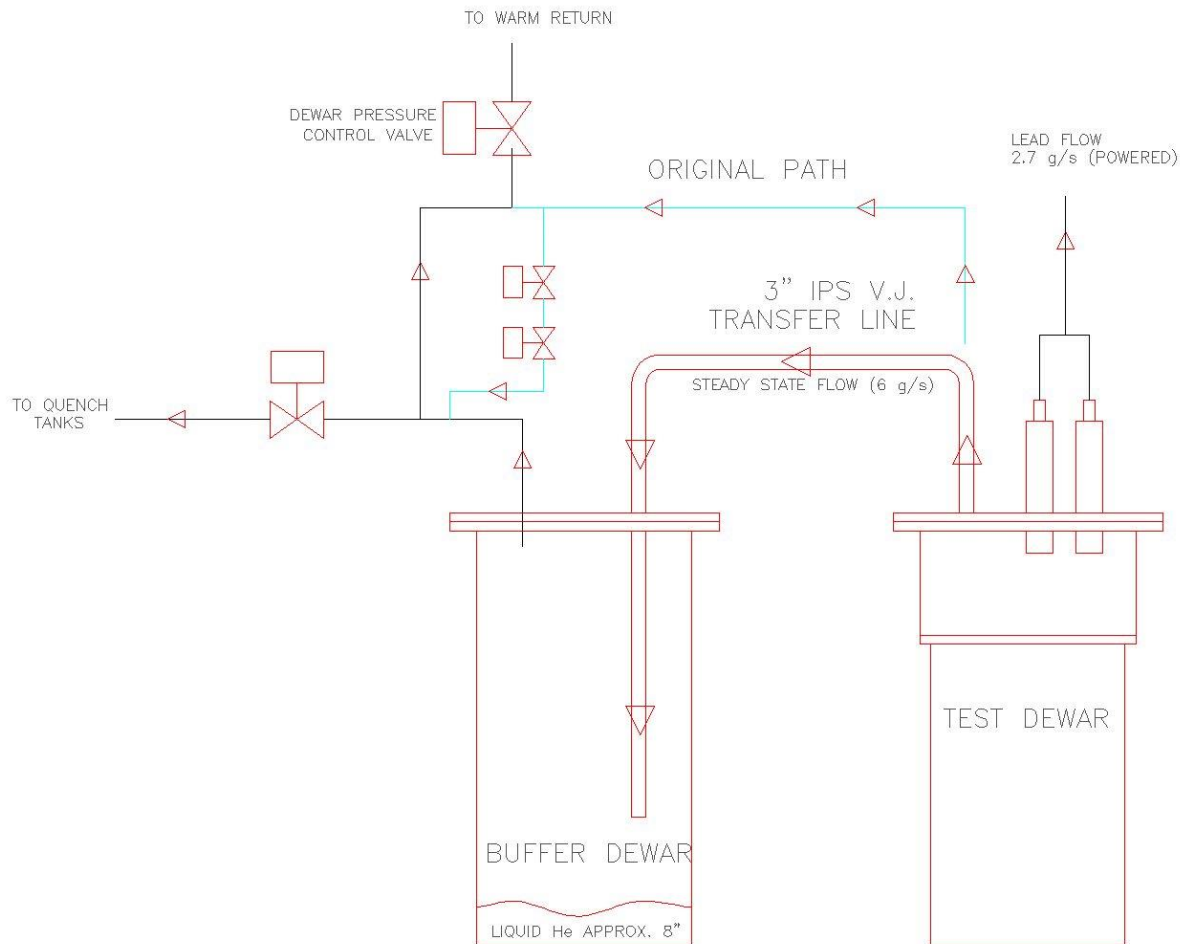

This slide courtesy of A. Marone