

Instrumentation for Particle Physics – in four lectures

Lecture II: Physical Phenomena used for Particle Detection; Detector Types; and Aging

Sally Seidel

University of New Mexico

African School of Physics 2021

Physical phenomena used for
particle detection, and detector
types that apply them

A particular type of detector does not have to make only one type of measurement – but *there is typically a primary purpose*, and possible secondary ones.

Detector types treated here:

1. Ionization counters using gas
2. Ionization counters using liquid
3. Ionization counters in the solid state
4. Scintillation counters
5. Photomultipliers/photodiodes
6. Cherenkov detectors
7. Transition radiation detectors

1) Gas-based ionization counters

Principle: a charged particle passing through a gas ionizes gas molecules; the pairs are separated by an electric field and guided to electrodes. Neutral particles that produce charged particles upon interaction with the detector can also be detected with this device.

If the incident particle is completely absorbed, the chamber measures its energy.

Consider a pair of parallel plane electrodes on opposite sides of an enclosed gas, separated by distance d .

Apply a potential U_0 across them. This produces a uniform electric field $E_x = U_0/d$. These electrodes are a capacitor with capacitance C . It has stored energy:

$$CU_0^2 / 2.$$

Consider a charged particle track traversing the volume, parallel to the electrodes. The particle produces pairs along the track. Assume none of these pairs produce secondaries, and none of the electrons are captured by the gas.

N drifting charge carriers produced at distance x_0 from the anode induce an electric charge on the electrodes. This modifies the voltage by ΔU . The stored energy is reduced to:

$$CU^2 / 2.$$

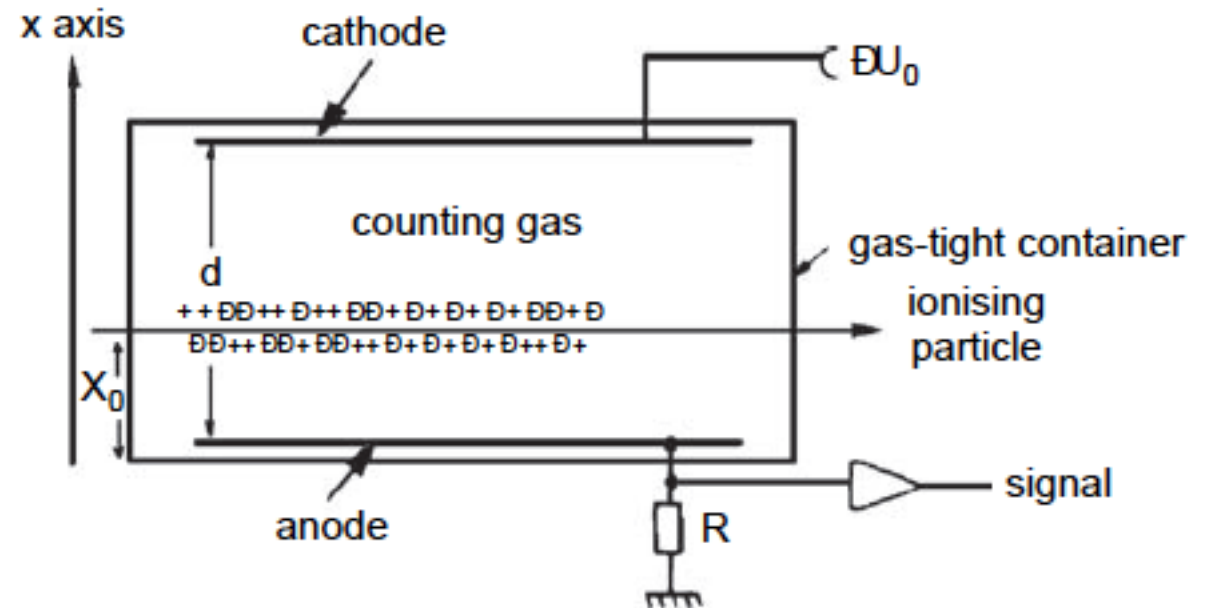

$$\frac{CU^2}{2} = \frac{CU_0^2}{2} - N \int_{x_0}^x qE_x dx$$

So:

$$\frac{CU^2}{2} - \frac{CU_0^2}{2} = -NqE_x(x - x_0)$$

We want to use this to find ΔU , which is the size of the signal induced on the electrodes.

Notice:

$$\frac{CU^2}{2} - \frac{CU_0^2}{2} = \frac{1}{2}(U + U_0)(U - U_0)$$

Notice $U - U_0 = \Delta U$

$$\text{So } \Delta U = -\frac{NqE_x(x - x_0)}{\frac{1}{2}(U + U_0)}$$

Assume that the voltage drop produced by the pairs is negligible, so $U + U_0 \approx 2U_0$.

Use $E_x = U_0 / d$.

$$\text{Then: } \Delta U = -\frac{Nq}{Cd}(x - x_0)$$

Notice that *the signal begins developing as soon as the pairs begin to separate* – before the pairs actually reach the electrodes.

Electrons travel faster than ions. Electrons and ions contribute to ΔU with the same sign, because they have opposite signs AND opposite drift directions.

Signal rises linearly until electrons reach the anode ($x = 0$), at which point,

$$\Delta U_{\text{due to electrons}} = \frac{Ne}{Cd}(-x_0)$$

This is increased as the ions reach the cathode, contributing

$$\Delta U_{\text{due to ions}} = -\frac{Ne}{Cd}(d - x_0)$$

Total signal amplitude is the sum:

$$\Delta U = -\frac{Ne}{C}$$

This assumes that the charging resistor R is infinite. Realistically there are RC corrections.

Typical values:

- electric field $E_x = 500$ V/cm
- electron drift velocity 5 cm/ μ s
- drift path 10 cm
- electrons collected in 2 microseconds, ions collected in 2 milliseconds.

-To decrease this collection time, often only electrons are collected.

-Modern ionization chambers are often cylindrical, not rectangular.

-Application of this technology: pocket dosimeter.

Proportional counters: *amplifying the signal through geometry*

Consider a *cylindrical chamber around a thin anode*. The electric field lines converge on the anode, so the magnitude of the electric field grows as $1/r$. Thus: ***the electric field can be very high, near the anode.***

When the field is high enough, an electron can gain enough energy from a collision to be able to ionize another electron. This increases the signal by the gas amplification factor A . Then:

$$\Delta U = -\frac{Ne}{C} \cdot A$$

The ability of a gas to amplify a signal, at a particular pressure and electric field, is given by the ***first Townsend coefficient α*** . If N_0 is the number of primary electrons, ***the number of produced electrons N at location x is approximately:***

$$N(x) = N_0 e^{\alpha x}$$

but in a cylindrical geometry, α depends on location, so actually:

$$N(x) = N_0 e^{\int \alpha(x) dx}$$

This is the gas amplification factor A .

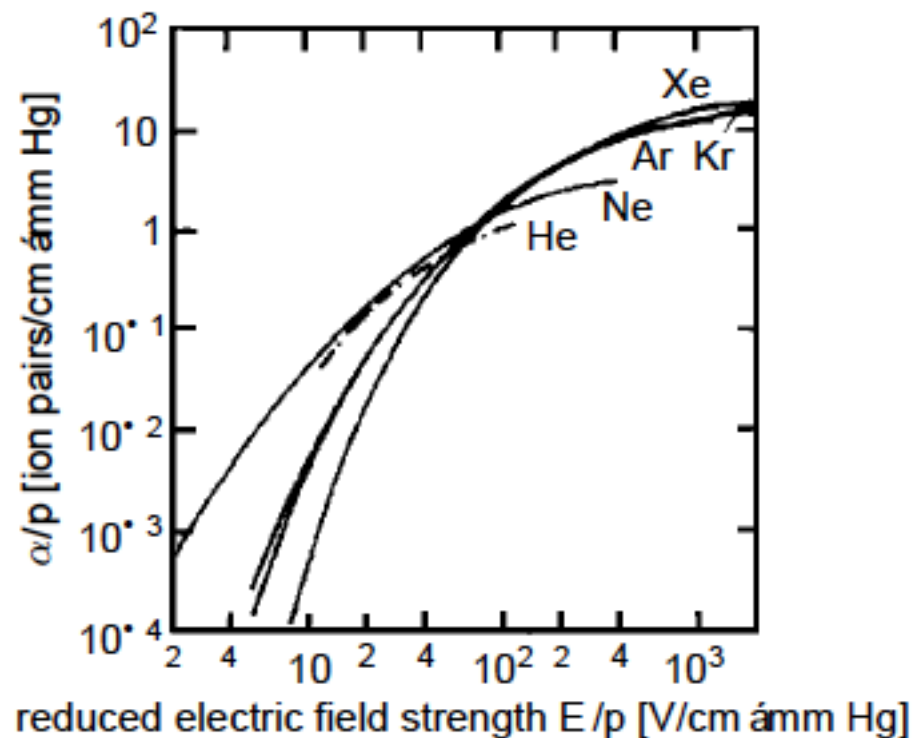

When the gas amplification factor A is a constant, the measured signal is proportional to the produced ionization: the detector is called a **proportional counter**. This is possible for values of A up to 10^6 , but typically in the range $10^4 - 10^5$.

Refine the model: note that at high electric fields, additionally atoms are excited, and then they decay by emitting photons. The photons can produce electrons through the photoelectric effect with the gas or the wall – these contribute to the avalanche, may produce more photons, more electrons, etc.

Including photon contributions, the amplification factor changes:

$$A \rightarrow A_\gamma = \frac{A}{1 - \gamma A}$$

γ is called the **Second Townsend Coefficient**.

When the avalanche is sufficiently large ($A_\gamma \sim 10^8$), it influences the electric field, leading to saturation.

Example use of proportional counters: radiation contamination detection, x-ray imaging for cosmic rays and medicine.

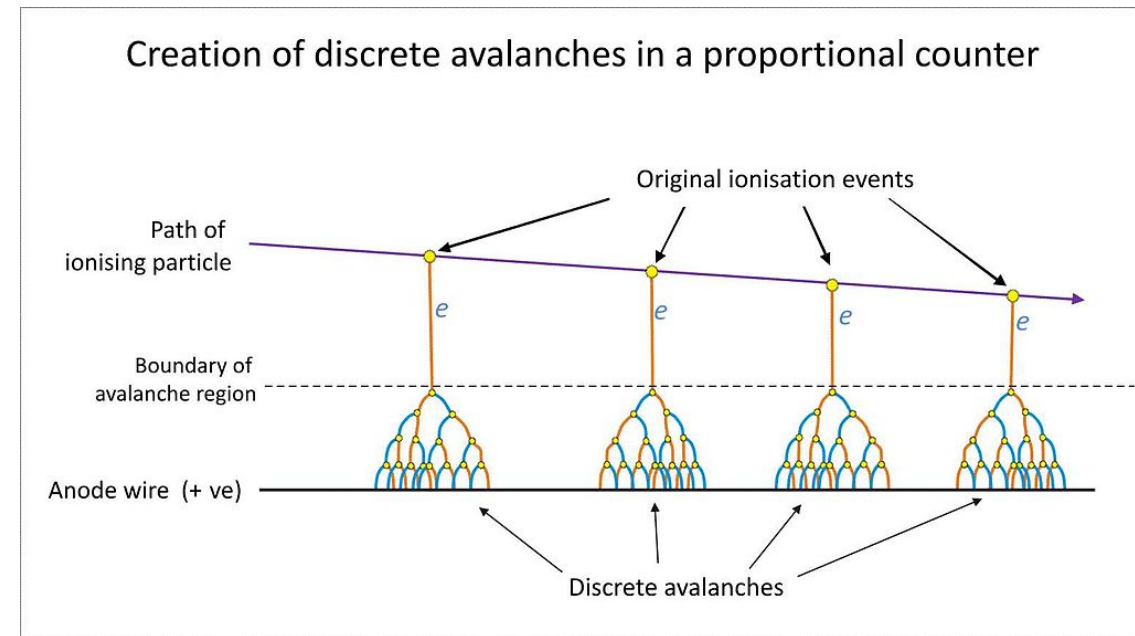

Beyond proportional mode:

Further increase the electric field. Coefficient γ grows, number of pairs increases, signal is no longer proportional to the primary ionization: **Geiger mode corresponds to $10^8 - 10^{10}$ electrons per primary.** Even after the electrons are collected at the anode, the ions striking the cathode can liberate new electrons, re-starting the avalanche, which propagates along the electrode, preventing detection of multiple simultaneous events.

To quench this signal: admix a small amount ($\sim 10\%$) of “*quenching gas*” to the *noble counting gas*. Quenching gases absorb photons in the UV, limiting the photon range to ~ 100 microns. These photons do not liberate cathode electrons because they are absorbed before they reach the cathode. Positive ions drifting toward the cathode are neutralized upon collision with quench gas molecules.

Typical *counting gases are noble*: argon, xenon, neon, krypton

Typical *quenching gases are hydrocarbons or alcohols*: methane, ethyl alcohol,...

Note on *historical detection mode*: if we increase the quenching gas fraction up to 40%-100%, avalanche is produced through photons re-absorbed locally via photoelectric effect; but discharge propagation along electrode is suppressed – this produces a large signal without amplification : “*streamer tube*” or “*Iarocci tube*”.

Arrow indicates anode wire position

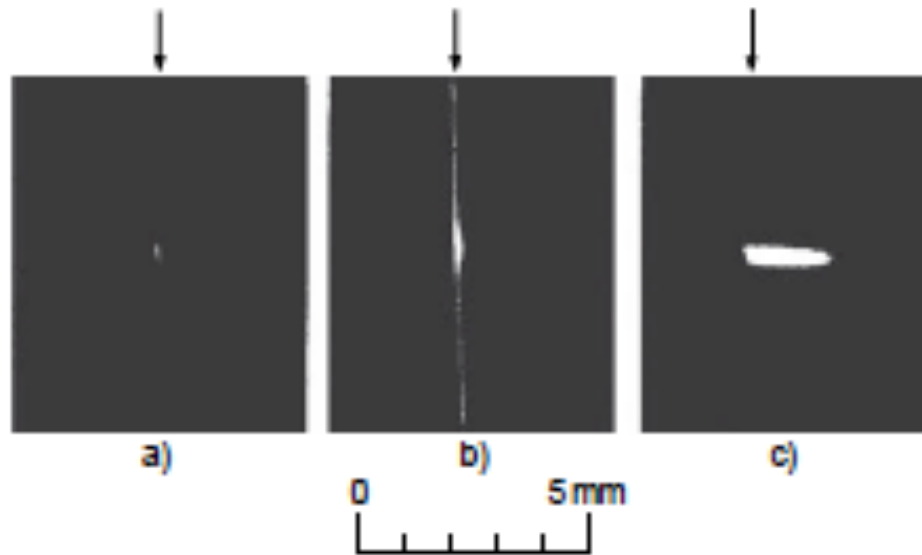

Proportional Geiger Streamer

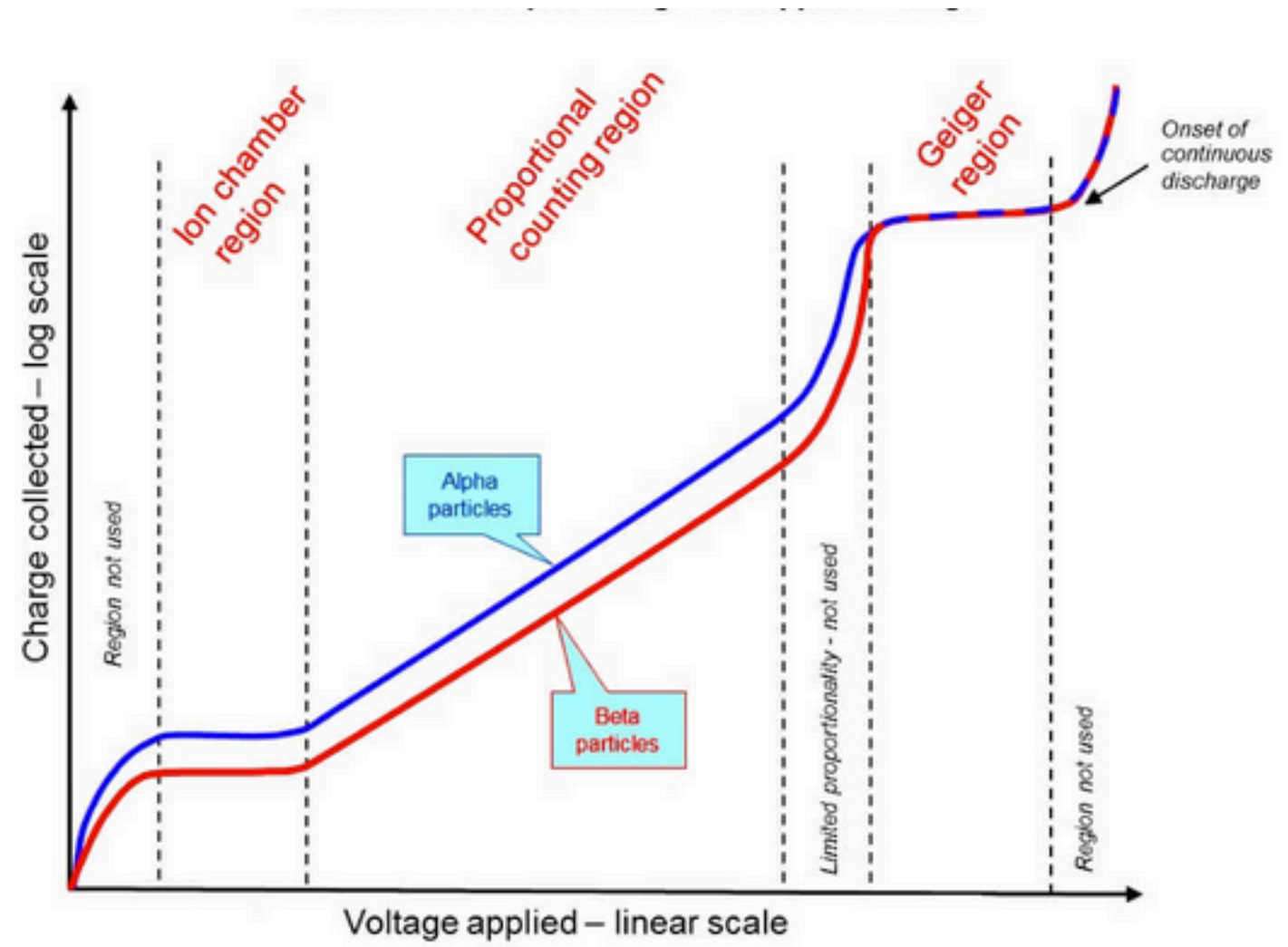

2) Ionization counters with liquids

- 1000x higher density – *increased energy absorption, photon detection efficiency.*
- Application to calorimetry
- Options in materials:

i) *Noble liquids* – 10's of eV to produce an electron–ion pair.

Disadvantages:

- must lower temperature to ~100K for liquid phase: *cryogenic equipment*
- High density -> slow electron drift -> require *purity* (no electronegative components).
- *Ion mobility is practically too small* to be useful.

ii) “*warm liquids*” – room temp.

- Need symmetric molecules for optimized drift: organic substances (tetramethyl silane (TMS), tetramethyl pentane (TMP)). For even higher density – replace Si with Pb or Sn to get tetramethyl lead or TMT.
- *Toxic, but these are radiation hard*
- High hydrogen content allows *compensation* (for e, h) in calorimetry applications – see Lecture 3.

Limitations of wire-based counters: rate and granularity, but with new materials and technologies, these are constantly improving.

3) Solid state ionization chambers

Typically silicon; but diamond, germanium are also explored. Electrons can populate the valence and conduction bands which are separated by E_{gap} . Through-going charge promotes electrons from valence to conduction, leaving hole in valence. The e-h pair drift to electrodes.

Low temperature – conduction band ~empty.

Classification by material resistivity (or band gap) at room temperature:

- $10^{14} - 10^{22} \Omega \text{ cm}$: **insulator** (example diamond). $E_{\text{gap}} > 3\text{eV}$
- $10^9 - 10^{-2} \Omega \text{ cm}$: **semiconductor** (example silicon, germanium). $E_{\text{gap}} \sim 1\text{eV}$

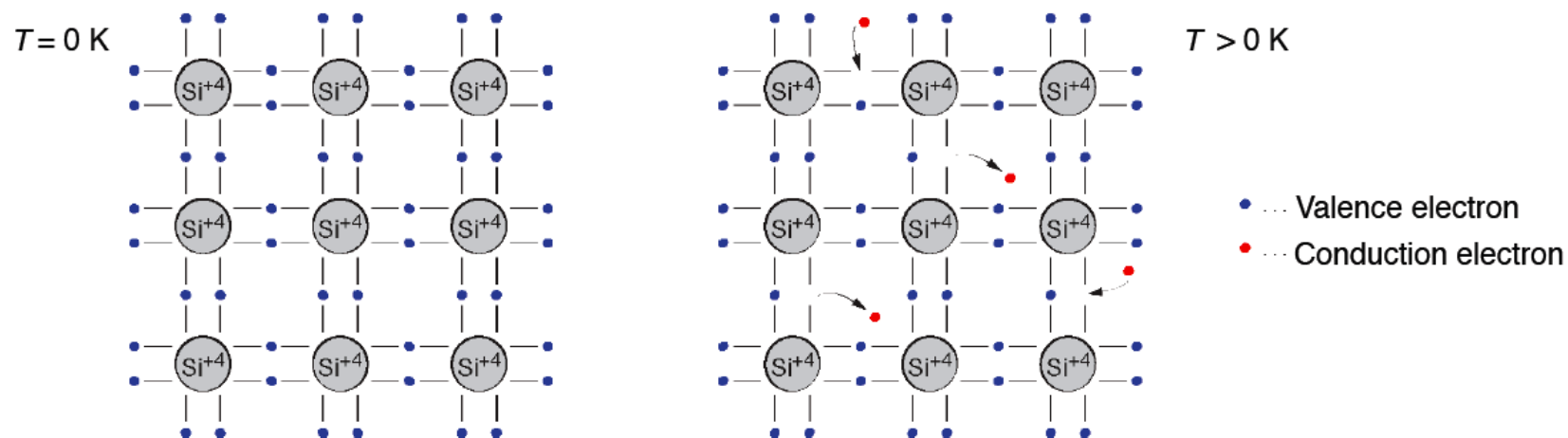
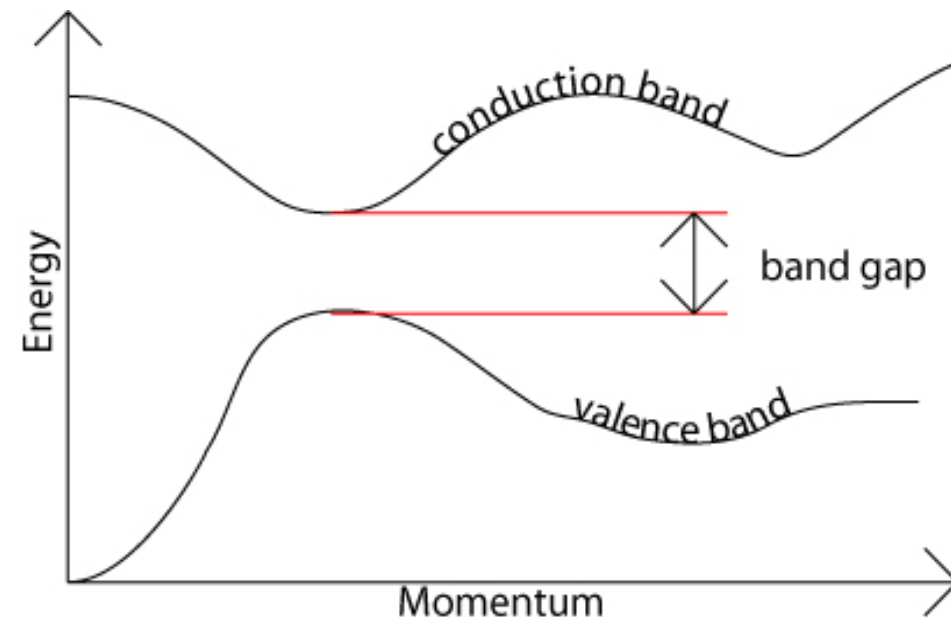

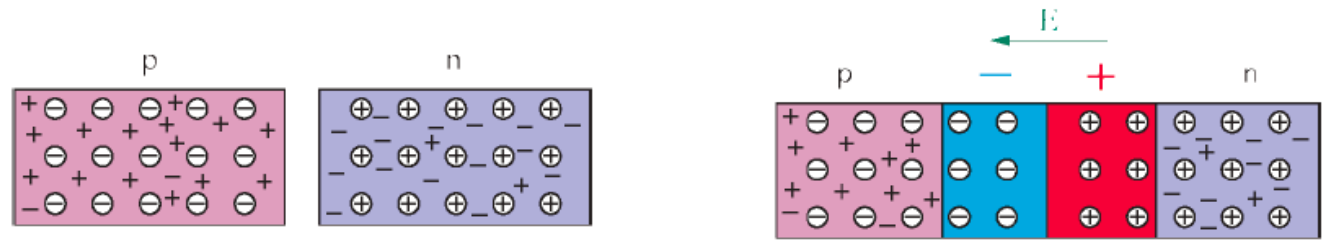

Semiconductor sensor:

- Suppress dark current by structuring as a pn junction, leading to emergence of depletion region in the material of lower carrier concentration; then deposition of highly doped n^+ layer, allowing application of reverse bias to expand the volume of depleted region to macroscopic dimensions – if resistivity is high

pn junction scheme

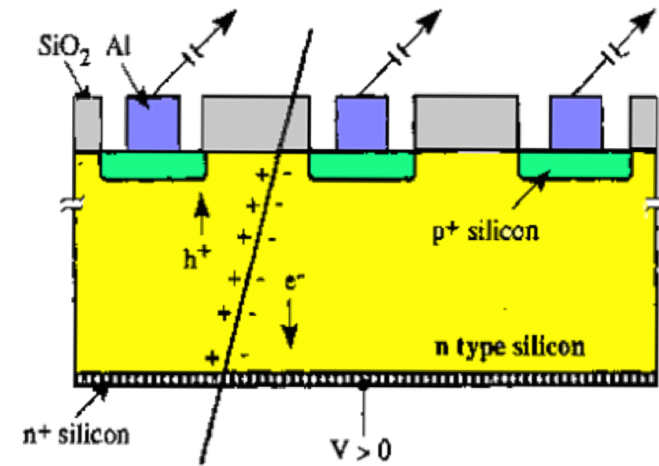
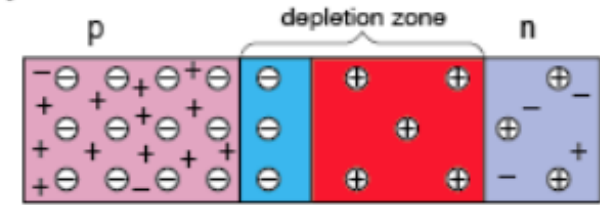

Semiconductor application, continued:

- Signal charge is proportional to energy deposited in depletion layer
- 3×10^4 pairs produced by a MIP crossing 300 microns of Si – requires low noise charge sensitive amplification.
- hole mobility is only 3 times less than electron mobility (compare case in gas where difference is 3 orders of magnitude) – so both species contribute to the signal.
- main application: particle tracking
- best S/N and suppressed annealing require cooling
- Resolution dominated by statistical fluctuation in production of eh pairs:

$$\frac{\sigma(E)}{E} = \sqrt{\frac{F \cdot W}{E}}$$

where F is Fano factor and W is energy required to produce a pair

- So W is the limitation on resolution.
- Note *for semiconductors*, $W \sim 3eV$, whereas *for gases and noble liquids* $W \sim 20-30 eV$

Beyond semiconductors:

- *For resolution better than that of semiconductors: **superconductors** rely on the evidence of the *breakup of Cooper pairs*. Disadvantage: cryogenics required.*

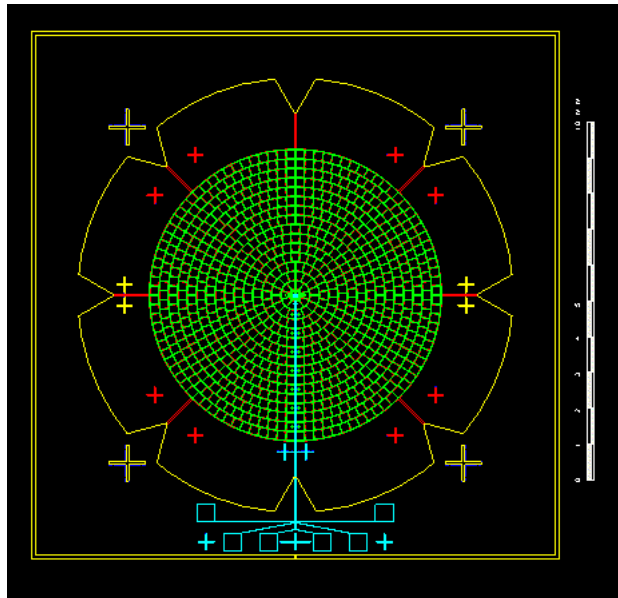
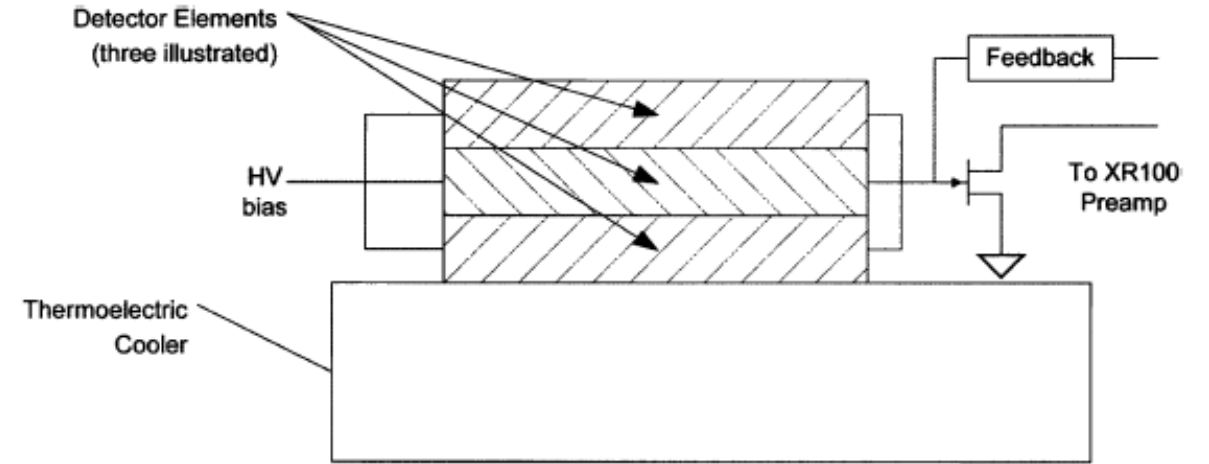

- *A **bolometer** is a sensitive detector of radiant energy – very low rate due to decay time of thermal signals – not conventionally used in HEP, but used in astronomy*

4) Scintillation counters

Principle: *a through-going particle excites a lattice, then de-excitation produces photons, which are transferred directly or indirectly (light guide) to an optical receiver (PMT, photodiode).*

Drawback: Production of 1 photoelectron requires more energy (~ 50 eV) than creation of an e^- - hole pair (3.65 eV in Si)

Advantage: Low cost of large volume scintillating material

These can be: *gas, liquid, organic solid, or inorganic crystals*

Characteristics:

- scintillation efficiency: energy of photons/energy absorbed by the scintillator
- light output: photons per MeV absorbed
- emission spectrum (must be matched to receiver)
- decay time(s) of pulse

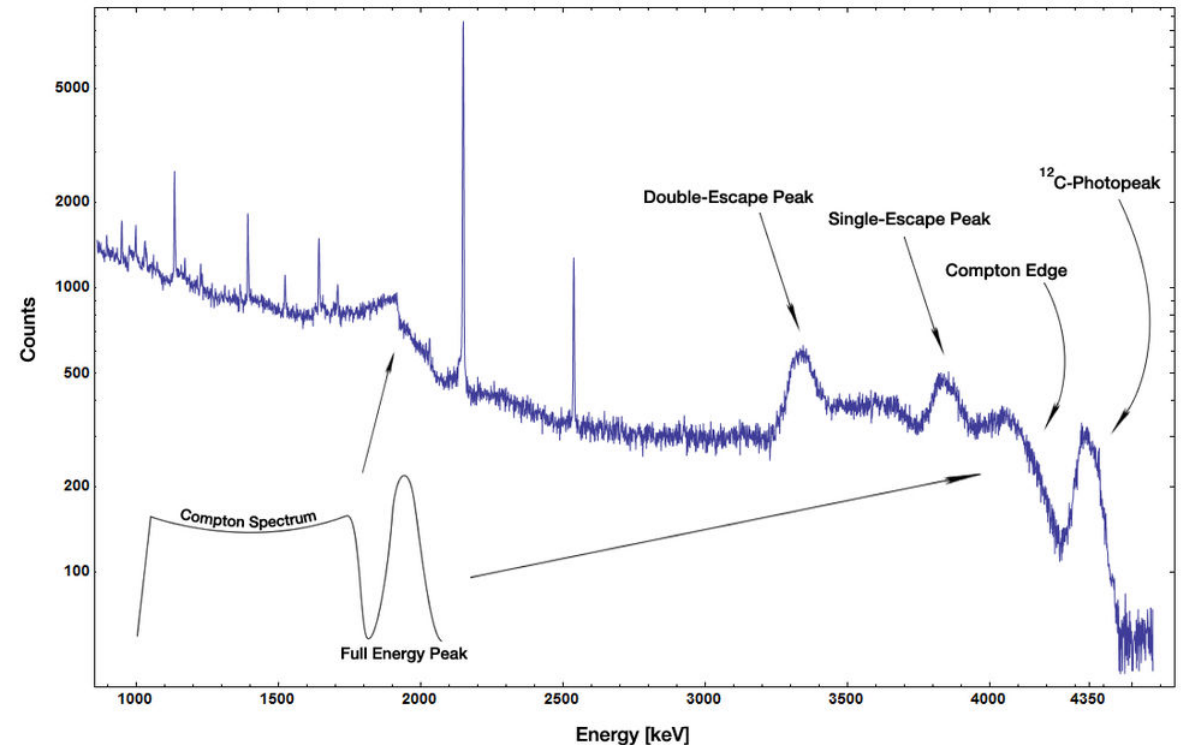

Scintillator considerations:

- Make the analogy to energy bands in crystals. The scintillator can absorb light as well as emit. So the device may need to be doped with wavelength shifting fluor to prevent self-absorption.
- De-excitation occurs in a longer wavelength. May add second fluor for optimal match to receiver.
- For maximum signal collection: all surfaces but the receiver-end should be totally internally reflecting.
- Ideally attenuation length $> 2m$
- Spectrum includes photopeak and a continuum due to Compton scattering which leads to incomplete absorption

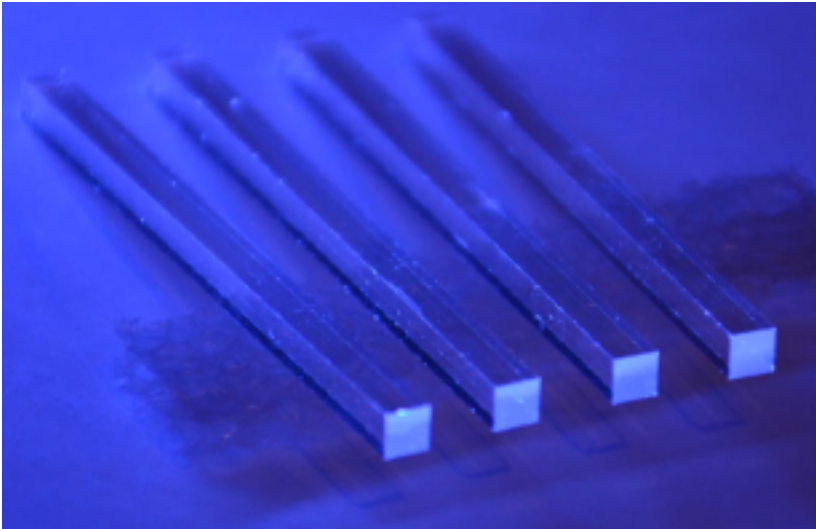
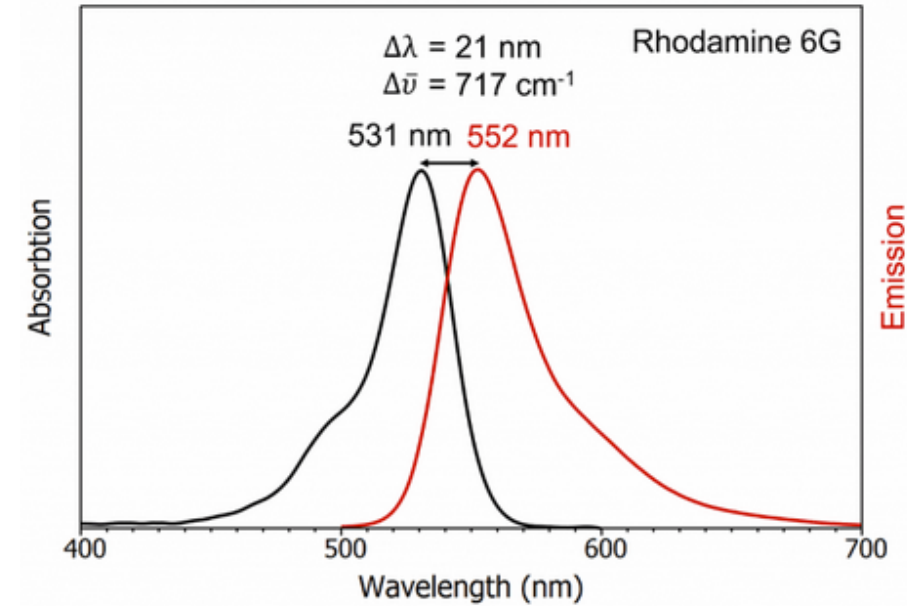

Example application: unwrapped crystal bars under UV illumination, for the LYSO:Ce precision timing layer in CMS)

Reading out a scintillator: *Photomultipliers*[†] and *Photodiodes*

They receive the light, then convert it to electrical signal via photoelectric effect at the *photocathode* – a thin semiconductor on a transparent window – in vacuum.

For the case of classical *dynode-based PMTs*:

- Negative high voltage on photocathode, ground at anode.
- Between them: dynodes (electrodes) at voltages linearly subdivided from high to ground.
- Each dynode multiplies the signal.

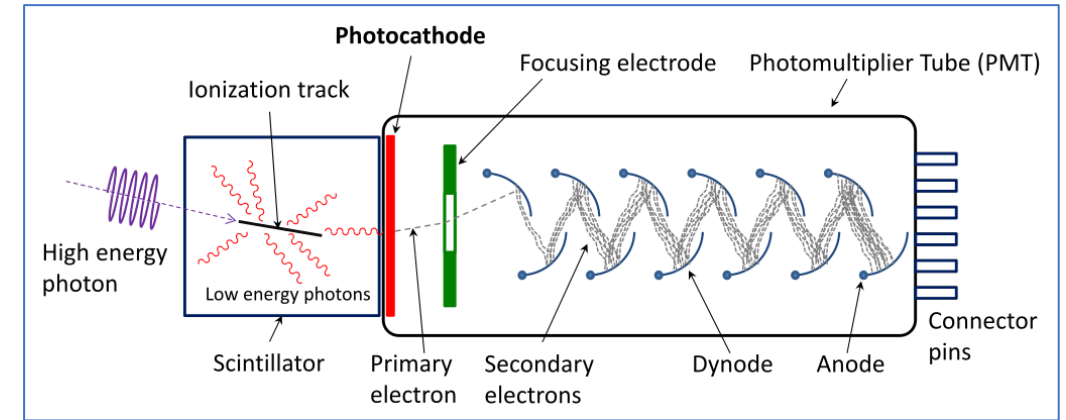

Alternative to the dynode chain: *micro-channel plate (MCP) PMTs*:

- MCP: a slab of highly resistive material, ~2 mm thick
- dense regular array of tiny tubes running from one face to the opposite.
- Microchannels are ~10 μm in diameter with ~15 μm spacing
- Channels parallel to each other and enter the plate at $\sim 8^\circ$ from normal to surface
- Strong electric field is applied across the plate.
- A particle that enters one of the channels is guaranteed to hit the wall of the channel, due to the angle.
- The impact starts a cascade of electrons amplifying the original signal

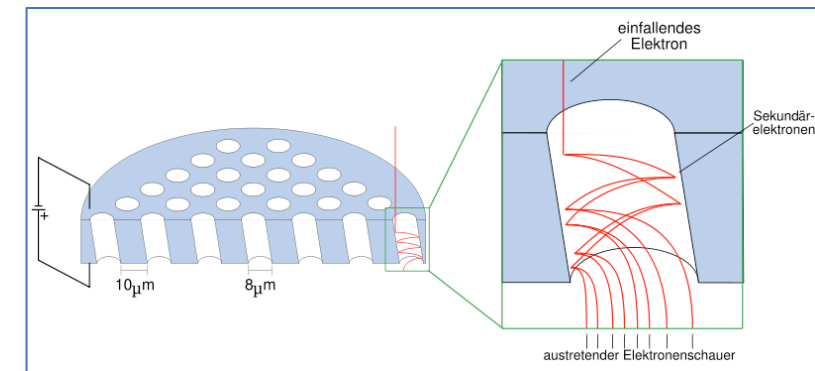

[†]Invented by Soviet physicist Leonid A. Kubetsky in 1930; subsequent controversy in primacy with V.K. Zworykin et al. of RCA in 1936.

Special terms:

- **Quantum efficiency** – mean number of photoelectrons per incident photon (25% - 95%)
- **Secondary electron emission coefficient** (typically > 5)
- For an **n**-dynode photomultiplier with secondary emission coefficient = **g**, **current amplification** is given by $A=g^n$.

Example PMT calculation:

- For $n=12$ and $g=4$, amplification factor $A= 1.7 \times 10^7$. Each photoelectron would lead to a signal of $2.7 \times 10^{-12}\text{C}$.
- For collection time $t=5$ ns, this is a current $I=dQ/dt=0.5$ mA.
- If the PMT is terminated by a 50Ω resistor, this produces a signal $\Delta V=IR=27$ mV.

Message: a single photoelectron (PE) can be detected.

Timing resolution is set by (1) spread in transit times of different PEs, (2) different velocities of different PEs

Example use of classical dynode PMTs in HEP: nucleon decay / neutrino experiments such as Kamiokande:

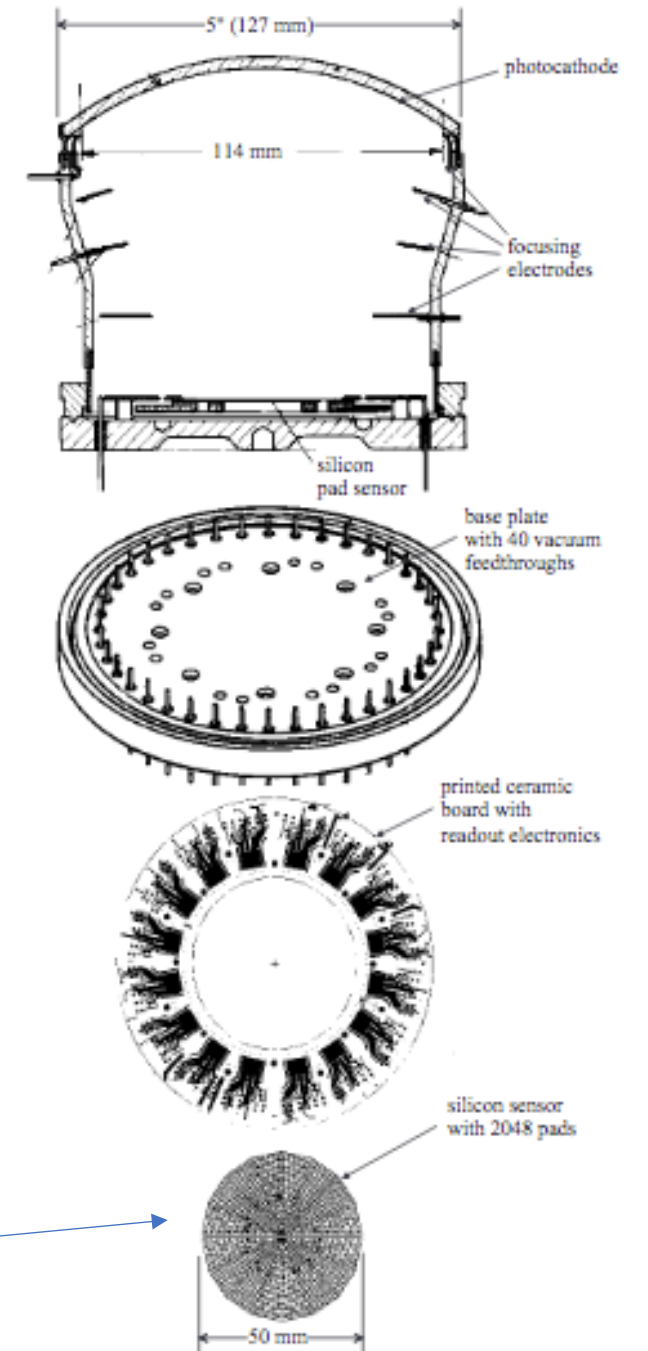
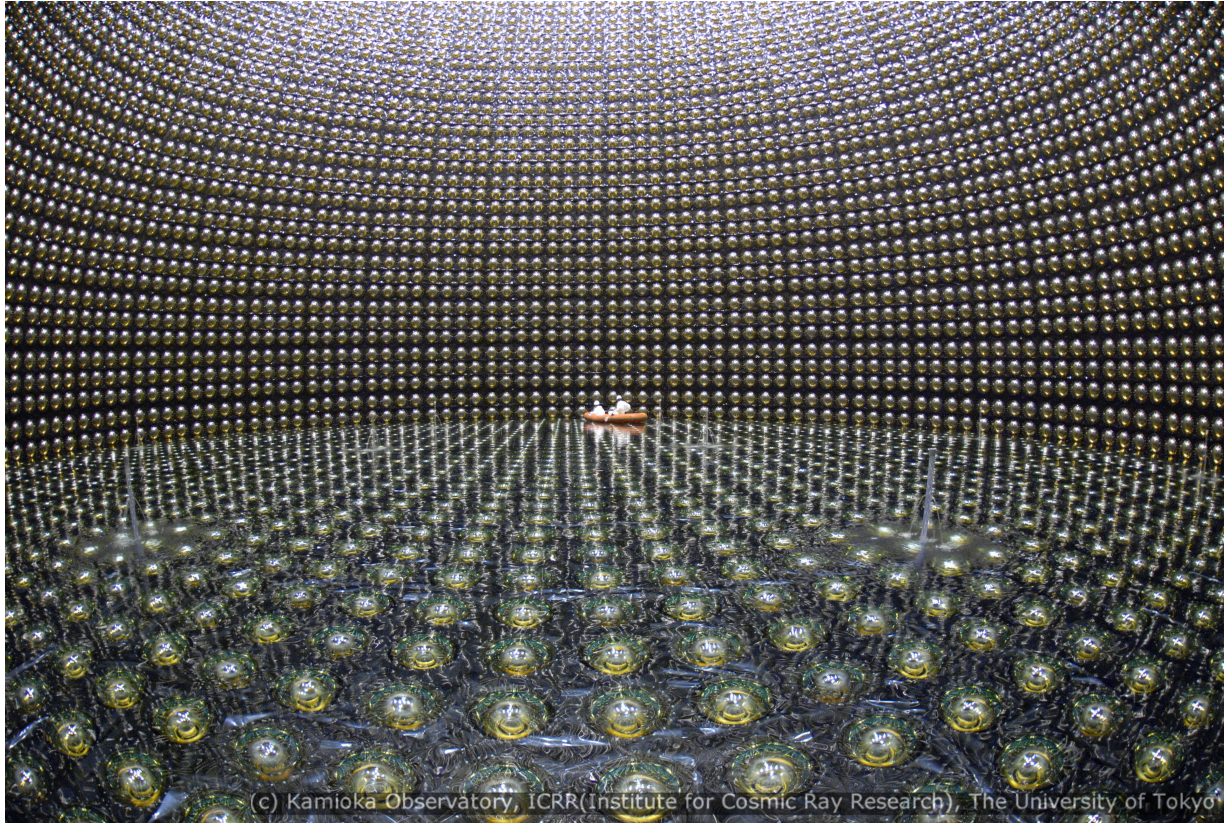

Photomultiplier anode can be subdivided to improve position resolution – ex: LHCb hadron calorimeter

Semiconductor photodetectors (photodiodes[†]) work similarly to semiconductor tracking detectors (i.e., as *pn* junctions), but with a transparent layer in front of the depletion volume.

When operated in proportional mode at high reverse bias, they manifest internal gain and are known as **avalanche photodiodes (APDs)**.

Increase the bias to Geiger mode – the basis for the **silicon photomultiplier (SiPM)**:

- array of avalanche diodes (dimensions 10 – 100 microns, density ~10000 per square inch)
- gain similar to that of a PMT, but linear vs. V_{bias}
- time jitter ~100-300 ps
- less sensitive to magnetic fields than PMT
- ultra-compact

- has been used to read out scintillators in the GlueX calorimeter, CALICE, T2K

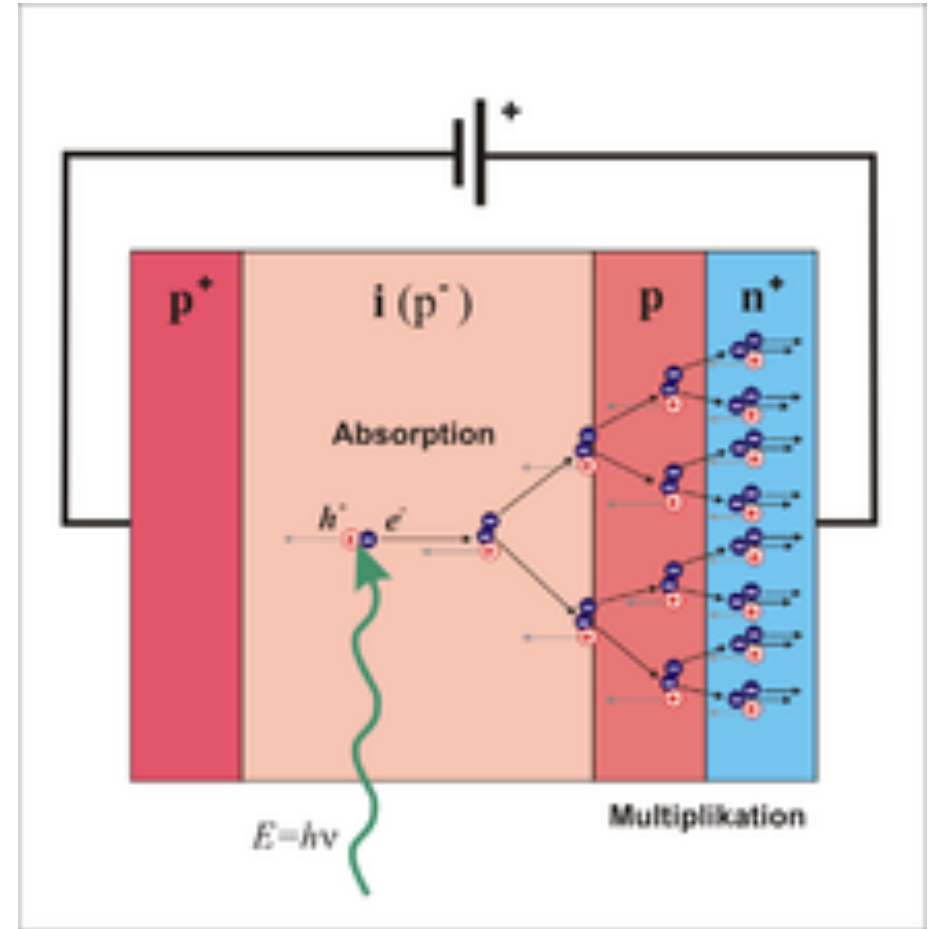

[†] Invented by John N. Shive, Bell Labs, 1948.

Cherenkov detectors

When a charged particle traverses a medium with index of refraction n at velocity $v > c/n$ (the phase velocity of light in the medium), Cherenkov radiation[†] is emitted. This is possible only because the phase velocity of light in materials is slower than the speed of light in vacuum.

The charged particle polarizes the medium, so atoms along its track become dipoles. The dipole moments superpose and their radiation forms a shock front. The angle of emission (Cherenkov angle) is given by

$$\cos \theta_c = \frac{c/n}{\beta c} = \frac{1}{n\beta}$$

where $\beta = v/c$, so these can be used to measure **particle velocity**.

Every Cherenkov detector needs a **radiator** and a **photon detector**.

One way to measure velocity is based on the *opening angle of the Cherenkov ring* that is formed (a **“RICH” detector**).

[†]P. Cherenkov, “Visible emission of clean liquids by action of gamma radiation,” Dokl. Akad. Nauk. SSSR 2:451.

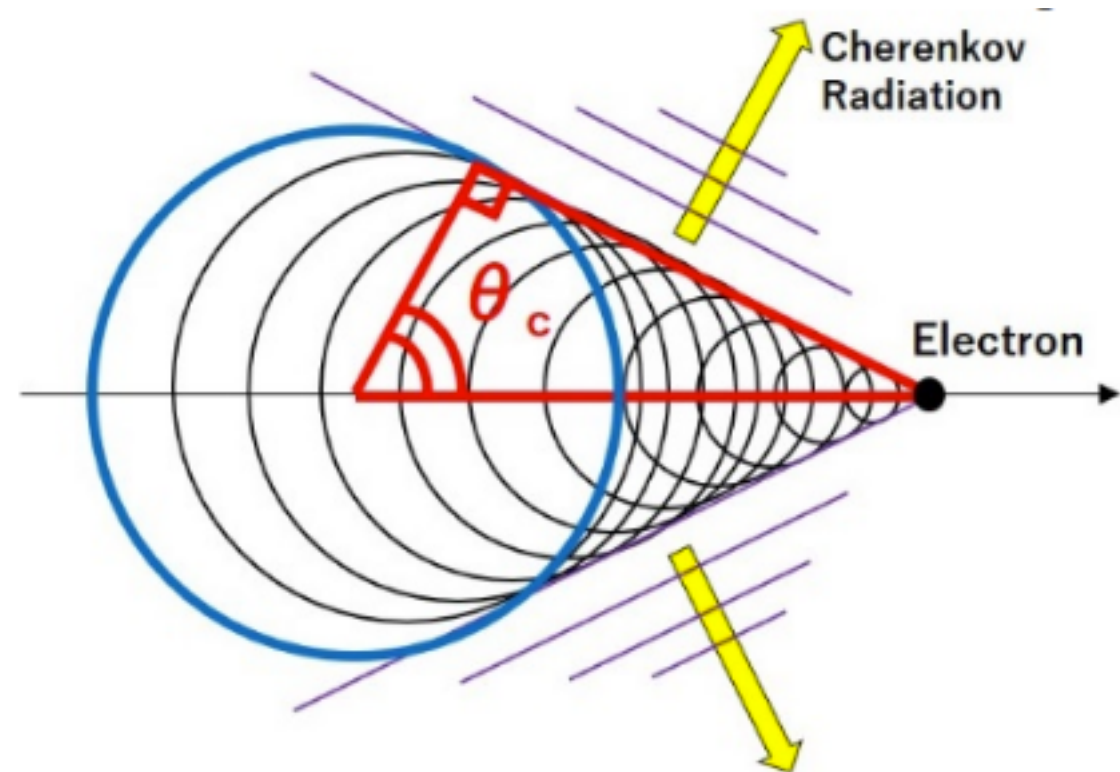

All transparent dielectrics can be Cherenkov media:

- Gases $n < 1.002$
- Silica aerogels (phase mixtures with air pockets) $1.01 < n < 1.13$
- Liquids $n > 1.33$
- Solids $1.6 < n < 4$

(Scintillation light is 100 x more intense than Cherenkov radiation so scintillators are not used.)

It is common for experiments to use more than one type of medium, to expand their range of momentum acceptance.

The choice of material requires consideration of *density, radiation length, radiation hardness, transmission bandwidth, absorption length, chromatic dispersion, optical workability, availability, and cost.*

Energy loss is small so these are typically not effective for calorimetry.

Ideally in a non-dispersive medium, the Cherenkov cone is arbitrarily thin, so the duration of the light pulse is a delta function. Research* has been done to use this to develop *fast counting devices* (time resolution ~ 10 ps) whose limitation is then in the MCP-PMT timing response.

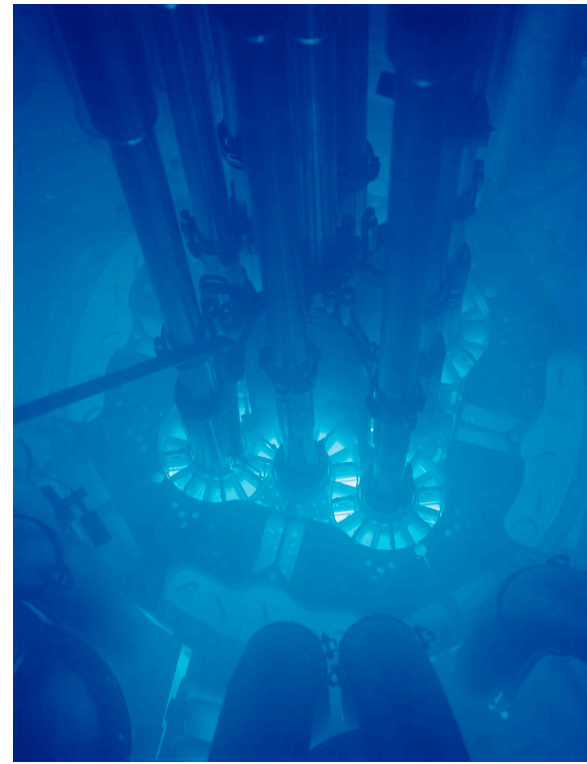

What Cherenkov light looks like: image from the glowing core of the Advanced Test Reactor

*J. Va'vra, "PID Techniques," Alternatives to RICH Methods," Nucl. Instr. Meth. A 876 (2017) 185-193.

Example Cherenkov counters in particle physics (more details in Lecture 4):

- STAR – discovery of anti-helium-4
- IMB, Kamiokande – use RICH technique for particle tracking and calorimetry in large water volume
- CRID (Cherenkov Ring Imaging Detector, J. Va'vra) – photosensitive area of large size (15 square meters) in a 5 kGauss magnet
- RICH (Rich Imaging Cherenkov Detector) – first used at LEP and Omega, later at ALICE, AMS, and LHCb
- DIRC (Direction of Internally Reflected Cherenkov light) – BaBar
- Imaging Atmospheric Cherenkov Telescopes (IACT) for high energy gamma ray detection: MAGIC, HESS, VERITAS, Cherenkov Telescope Array (CTA)

Transition Radiation Detection (TRD)

When a charged particle crosses *a boundary between media with different dielectric constants* (including a boundary with vacuum or air), the charged particle moving toward the interface forms, with its mirror charge, *an electric dipole with time-dependent moment* (and the dipole vanishes when the particle enters the medium). An effect of this is that *transition radiation* is emitted with wavelength in the x-ray regime.

Angle of emission of TRD photons:
$$\theta_{TRD} = \frac{1}{\gamma_{particle}}$$

This provides a technique for particle ID.

- Probability for emission of a transition-radiation photon $\propto 1/137$ at each boundary.
- To increase the #photons – increase the #boundaries by layering foils + air gaps.
- Foils are low-Z to prevent self-absorption of the x-rays.
- For a periodic stack of foils + air gaps, interference produces a threshold such that particles with $\gamma < 1000$ do not radiate.

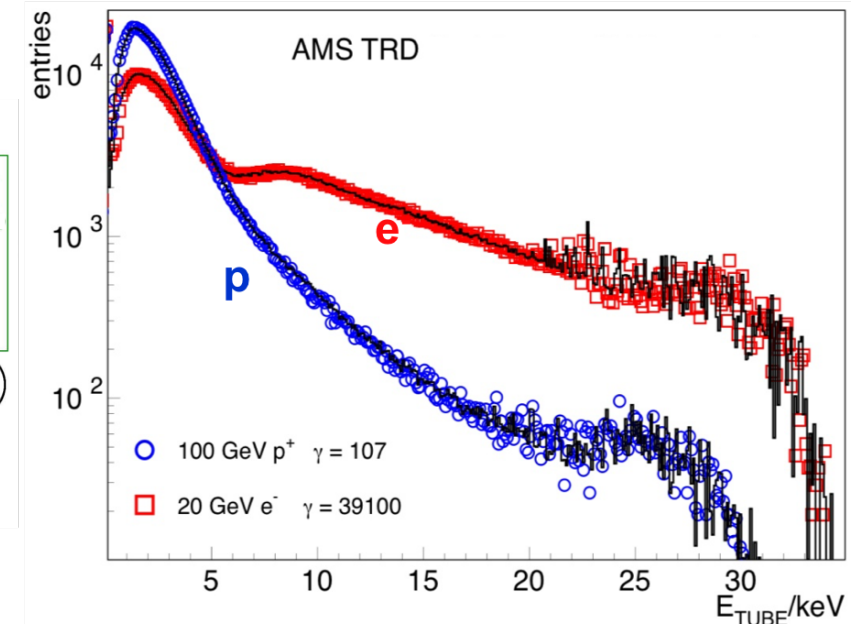
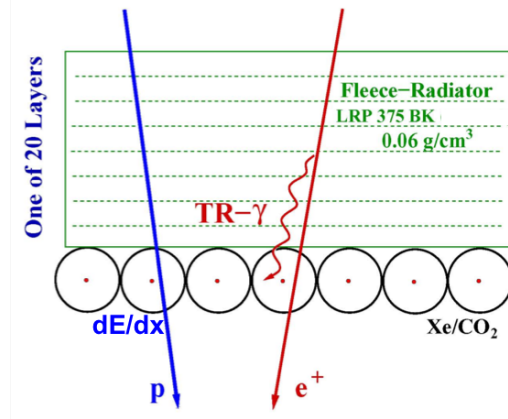

Advantage of TRD: energy radiated \sim Lorentz factor γ - so remains effective as $\beta \rightarrow 1$, when velocity detectors saturate²⁶

Issues with TRD implementation:

- *Thickness of the foils:* minimum necessary to establish an equilibrium field inside - typically 30 μm thickness and 300 μm separation
- *Number of foils:* as this increases, reabsorption of the radiation grows, so low-Z materials are used
- The foil radiators must be followed by a *photon detector* (e.g. MWPC). The small angle of the TRD radiation means the particle traverses this detector too, *producing Landau-shaped dE/dx loss*.
- The dE/dx and transition radiation signals are similar and must be separated by comparison of characteristics (ionization source, total ionization charge) of the charge cloud to *a likelihood model*, for samples over *a depth of 10-30 radiator/detector units*.

Detector Aging and Radiation Effects

The message: Up to this point we've provided information on phenomena that are used for particle detection. **But the same particles that traverse the detector also damage it.** So the *detectors need to be robust against radiation damage and aging.* That is what this section is about.

Typical particle fluences applied to detectors in HEP now are $10^{15} - 10^{16} \text{ cm}^{-2}$. Fluences above 10^{17} are foreseen in future detectors.

Radiation environment simulated at the FCC-hh after 30 ab^{-1} :

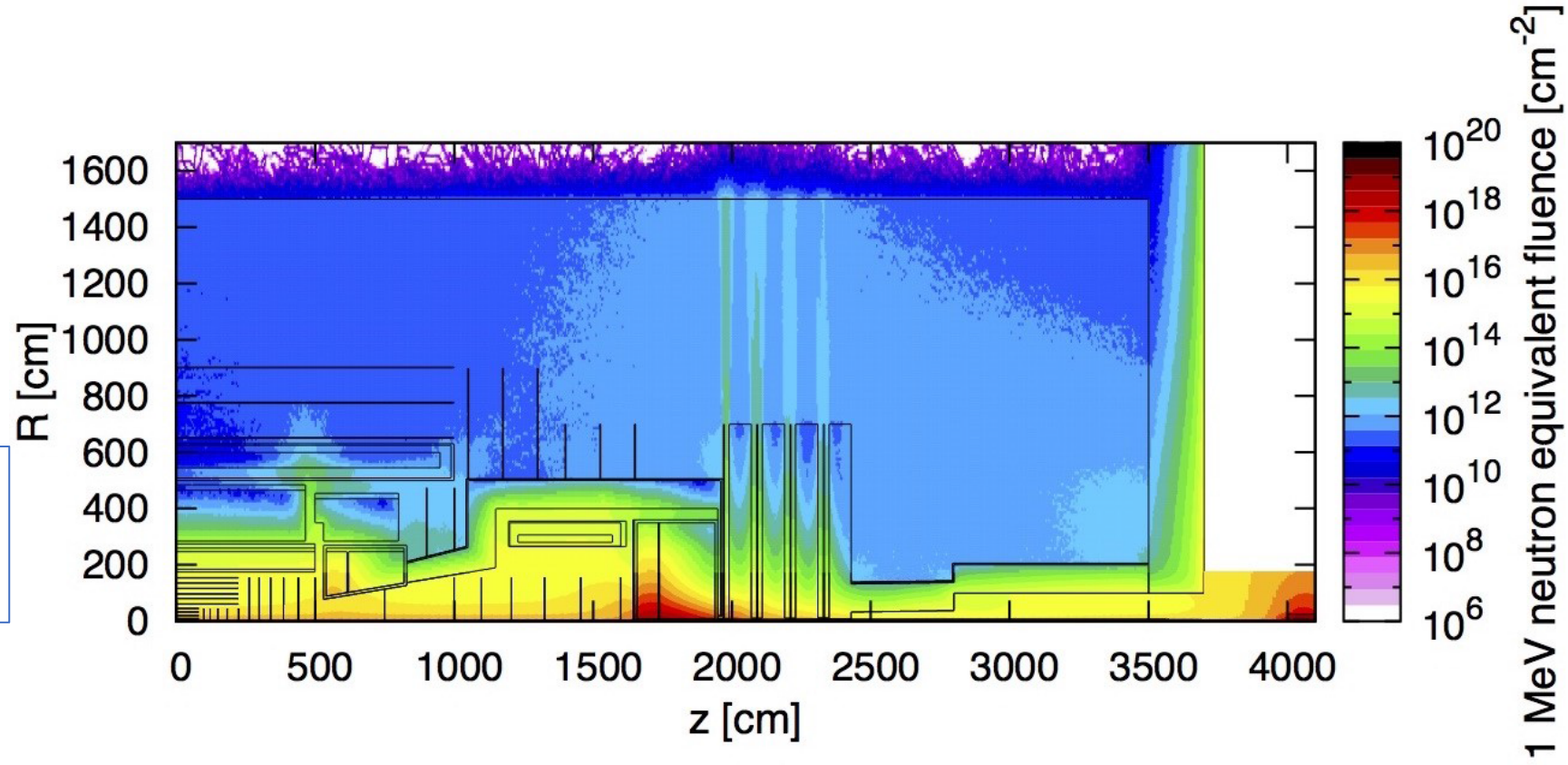

Avalanches of electrons and ions are plasmas.

- These break down molecular gases, leaving *free radicals*, with large dipole moments, that form polymers. Polymers are electrically attracted to and attach to electrodes. This “anode coating” is larger than the anode itself, which reduces gas amplification and eventually renders the chamber unusable. The energy needed to break a covalent bond in the gas is typically only 1/3 of the ionization energy.
- *Contaminants* can nucleate and accelerate this process – even from fingerprints during construction, or outgassing and silicon oil droplets during manufacture (leads to low volatility compounds that are hard to expel), at levels of ppm.
- Dangling polymers can lead to sparking – irreversible damage to components.

Careful selection of components can make a difference.

- Quenching gas choice
 - Some gas molecules are easier to decompose (e.g. dimethyl-ether survives better than methane).
- Wire diameter
 - Constant-thickness coating will have a larger impact on thin than thick wires.
- Metal plating choice
 - Gold is less reactive than Ni/Cr/Al/Cu

Radiation damage to scintillators, Cherenkov media, wavelength shifters, readout fibers

Radiation causes breaks and cross-linking in scintillator bases; changes of the structure of scintillator polymers; produces free radicals (“color centers”) that absorb and scatter scintillation light and yield gaseous products.

Outcomes:

- (1) Reduced light yield
- (2) Reduced transmission, depends both on total dose and dose rate.
 - some scintillators can partially recover as radicals are neutralized by O_2 .
- (3) Modified mechanical properties – brittleness.
- (4) In Cherenkov media – change of the index of refraction.

- Gammas, betas, hadrons have different damage capabilities
- Liquid scintillators are generally more robust to radiation than are solids.

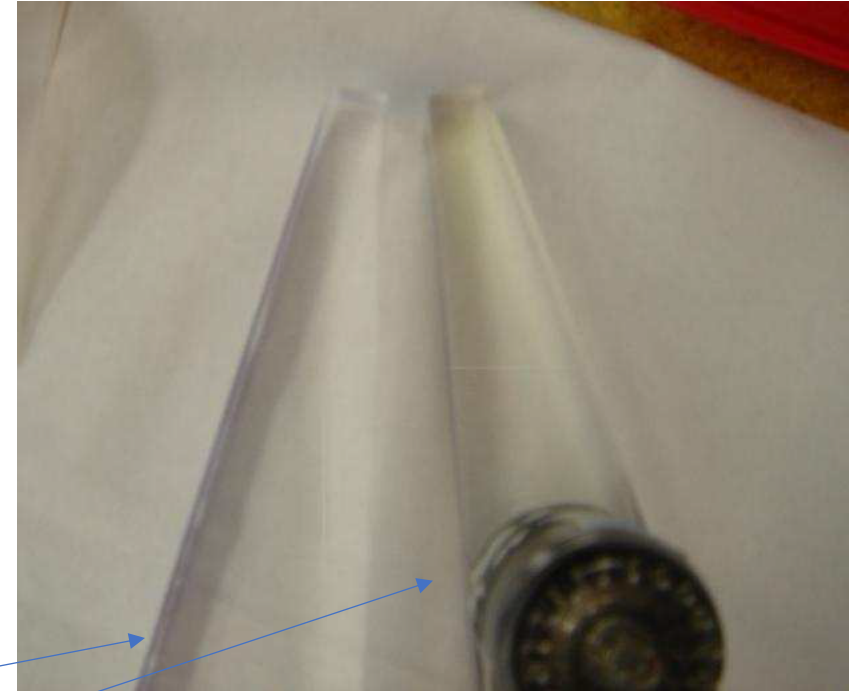

A new (clear) and an old (yellowed) scintillator in the D0 luminosity monitor

Radiation damage to silicon detectors

- Displacement of atoms from the positions in the lattice (“bulk defects”) lead to states within the bandgap that promote extra *leakage current*.
- Carriers temporarily trapped in those states require increased *depletion voltage*.
- Extended time of charge trapping is effectively *signal loss*.
- Cascading damage can lead to clusters of defects.
- Bulk damage sites are mobile and typically continue to worsen after the conclusion of the irradiation process (“reverse annealing”).
- Surface damage can lead to dangling bonds and associated charge build-up on the surface – *loss of inter-channel isolation and increased surface current*.

But the good news is...

- Cooling inhibits current.

- Radiation tolerance can be engineered: For example, addition of oxygen to the silicon bulk improves hardness against charged particles but not against neutrals.

