

What's the Matter with Antimatter?

Chris Ørum Rasmussen



AARHUS UNIVERSITY



About Me

2011 Bachelor, Aarhus University

2014 MSc, Aarhus University

2016 PhD, Aarhus University

Have been working on the
ALPHA experiment since 2010



AARHUS UNIVERSITY

Antimatter

Paul A. M. Dirac

1928 Publishes his equation
of motion for the electron

1931 Predicts the existence
of the positron

$$i\hbar\gamma^\mu\partial_\mu\psi - mc\psi = 0$$

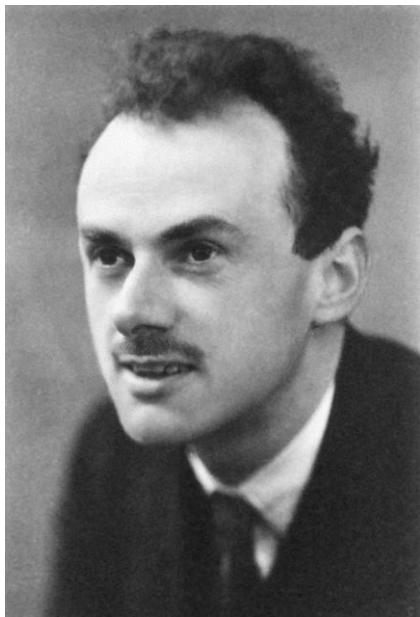

AARHUS UNIVERSITY

Discovery of the Positron

Carl D. Anderson, 1932

- Studying cosmic particles with a bubble chamber
- Particles would lose energy in lead barrier, allowing the charge to be determined
- Found a light, positively charged particle

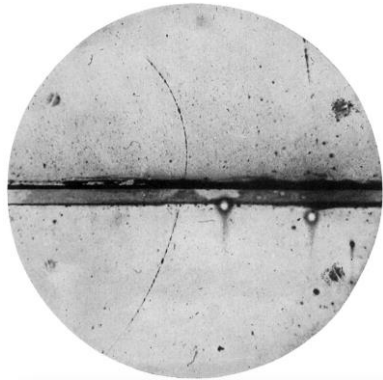

AARHUS UNIVERSITY



What is Antimatter?

Every particle has an antimatter counterpart with:

- Identical mass
- Identical lifetime
- Opposite charge
- Opposite spin

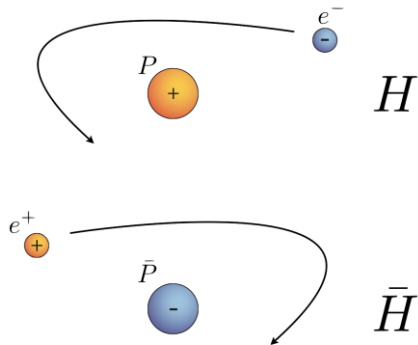

Antimatter Annihilates

$$E = mc^2$$

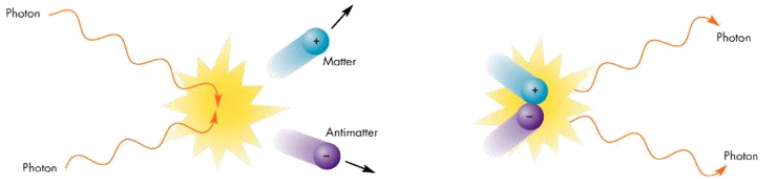

Antimatter Annihilates

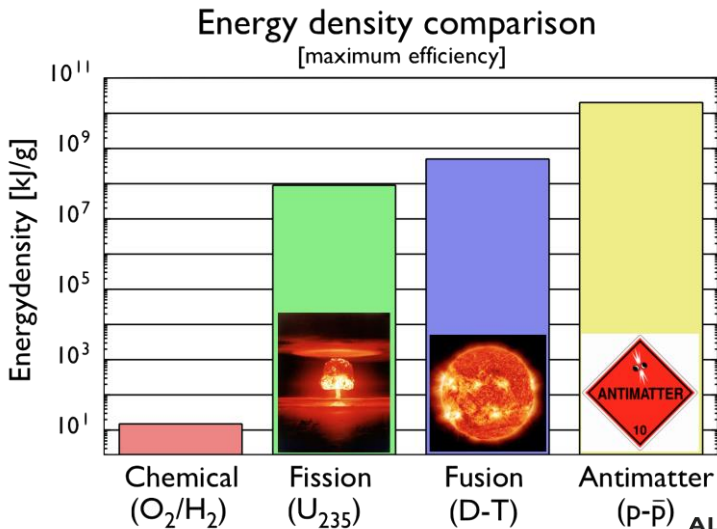

Antimatter as Rocket Fuel?



No!

Highest production of \bar{p} : 10^{11} per hour (1.67×10^{-13} g/h)

Would take 5 years to boil 1L of water.



AARHUS UNIVERSITY



(Serious) Reasons for Studying Antimatter

Antimatter allows for direct tests of fundamental symmetries and may hold clues to some of the biggest unanswered questions in physics:

- Why is there no antimatter in the Universe (Baryon asymmetry)
- Is CPT symmetry conserved?
- Does the weak equivalence principle hold for antimatter?



Baryon Asymmetry

- Observations show no evidence for large scale antimatter in the Universe
- No satisfactory explanation, consistent with experiment, has been given
- This is one of the main arguments for the incompleteness of the Standard Model in its current form

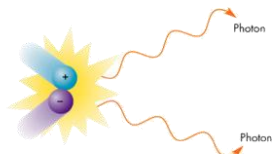
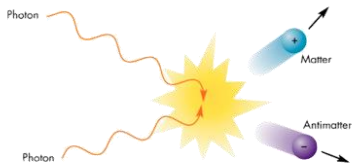

CPT Symmetry

- Combination of the Charge conjugation, Parity inversion, and Time reversal symmetries
- C, P, and CP are each broken in the standard model
- No process has been observed to break CPT symmetry
- CPT symmetry is proven to hold in any quantum field theory which:
 - Is Lorentz invariant
 - Is local
 - Has a Hermitian Hamiltonian
 - Is flat



Antimatter gravity: The Weak Equivalence Principle

In Einstein's general relativity, *any body must experience the same acceleration in the gravitational field, regardless of its composition*

This is expected to hold true for antimatter, but a direct, model-independent test has not been made



AD



The AD Experiments

- 6 experiments share the beam from the Antiproton Decelerator
- All are built to compare matter to antimatter at low energy and with high precision
- This is the only place in the world that low energy antimatter can be studied



ATRAP



The ALPHA Experiment

Antihydrogen Laser **PH**ysics **A**pparatus

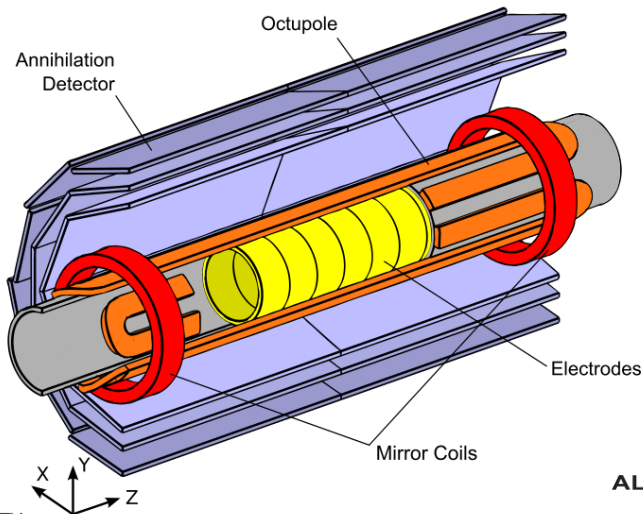

Why Antihydrogen?

- Antihydrogen is the only pure antimatter atom we can make so far
- Hydrogen is the best understood atomic system
- Comparing the two can test matter-antimatter asymmetry and CPT
- Antihydrogen is neutral (important for gravity)

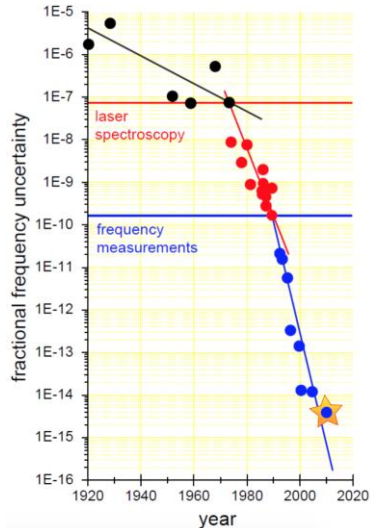

Penning trap

Charged particles are contained by an axial magnetic field and a series of cylindrical electrodes.

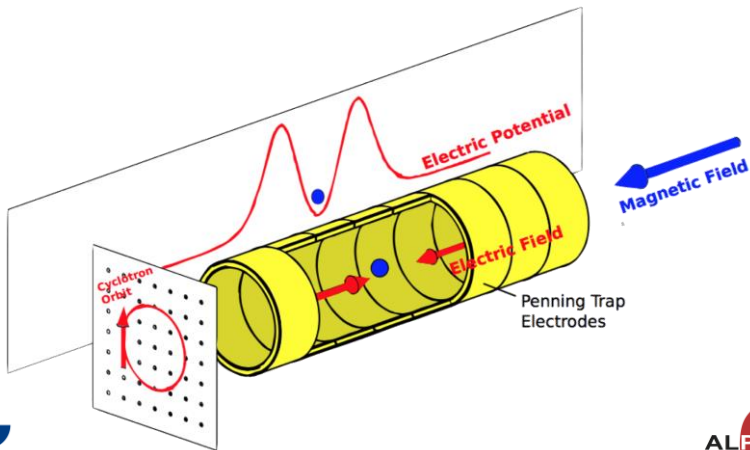

Magnetic Minimum Trap

Create a minimum of the magnetic field in 3D

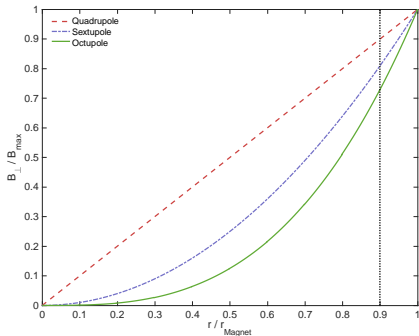
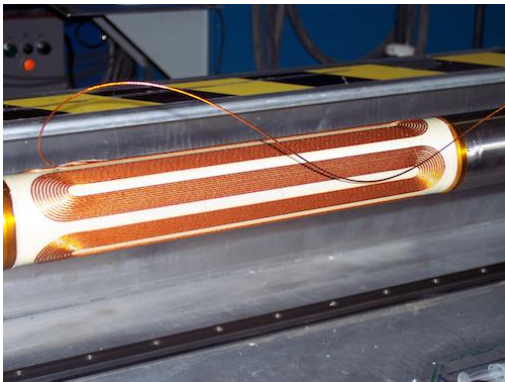

AARHUS UNIVERSITY



Microwave Spectroscopy in Antihydrogen

Flip the spin of the positron to expel atoms from the trap

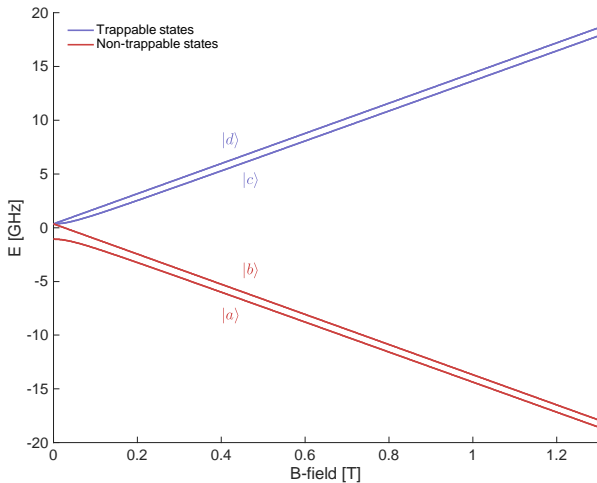

Microwave Spectroscopy in Antihydrogen

Two transitions with constant separation

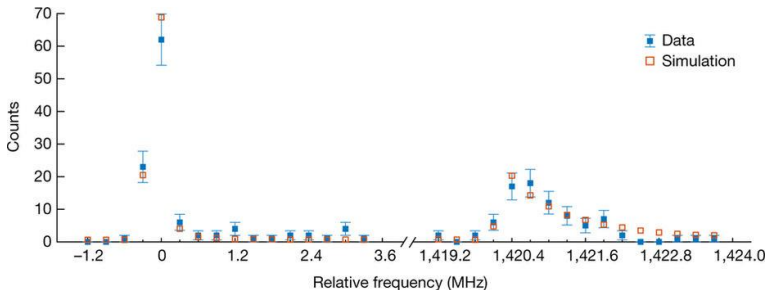

Laser Spectroscopy in Antihydrogen

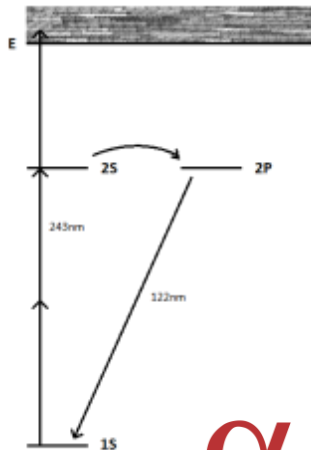
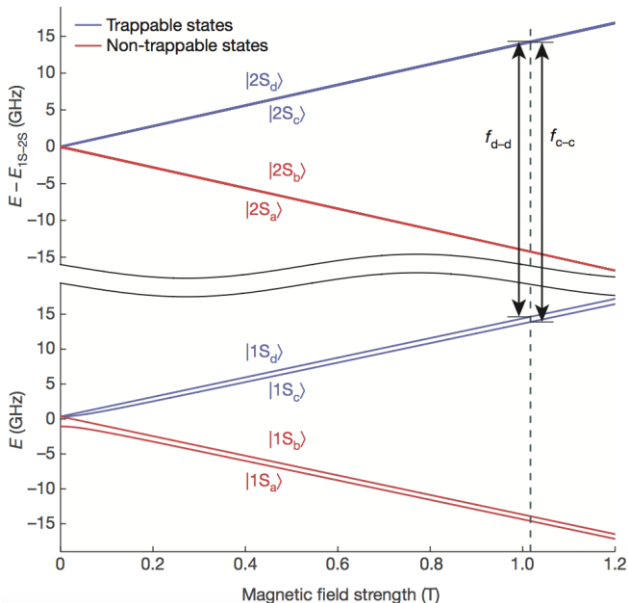

ALPHA α

Laser Cavity

Mirrors are in UHV and at cryogenic temperatures.

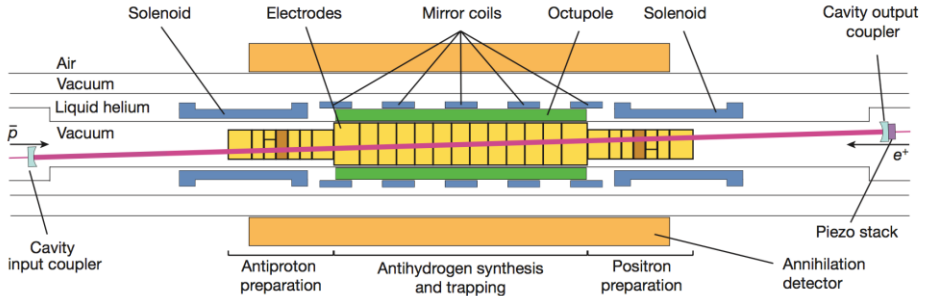

AARHUS UNIVERSITY



Video!



AARHUS UNIVERSITY



1S-2S Spectroscopy

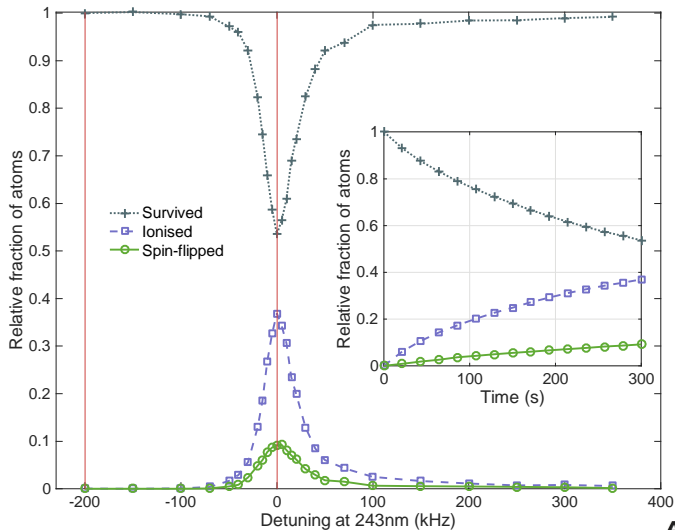

AARHUS UNIVERSITY



CPT Tests and Relative Precision

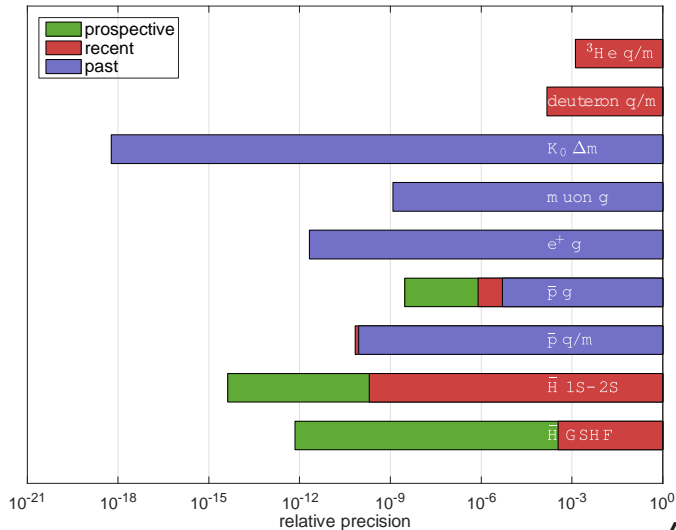

CPT Tests and Relative Precision

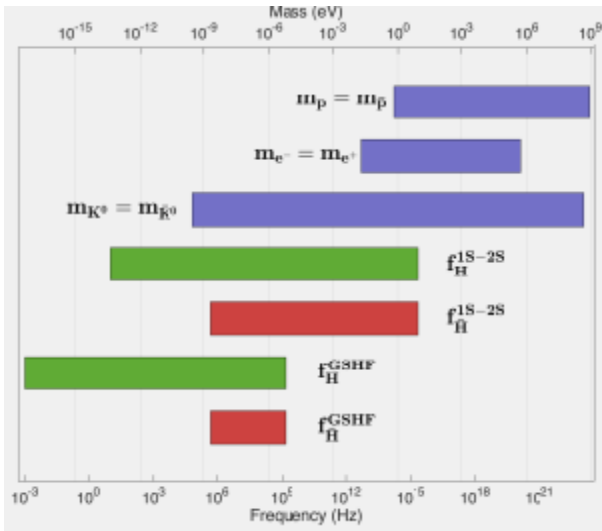

Any Questions?



AARHUS UNIVERSITY



The Elementary Particles of the Standard Model

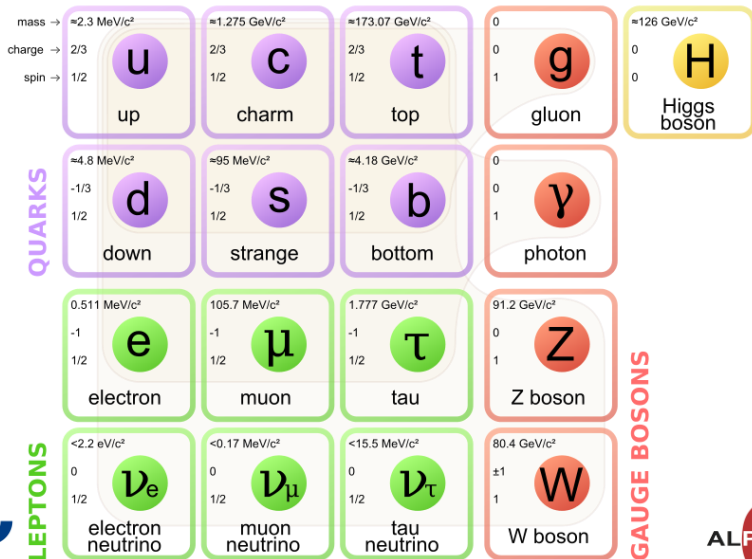

Cosmic Event Rejection

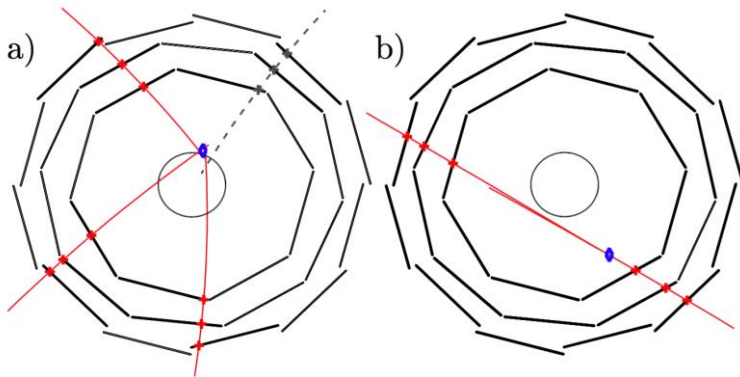

AARHUS UNIVERSITY



Antiproton Discrimination

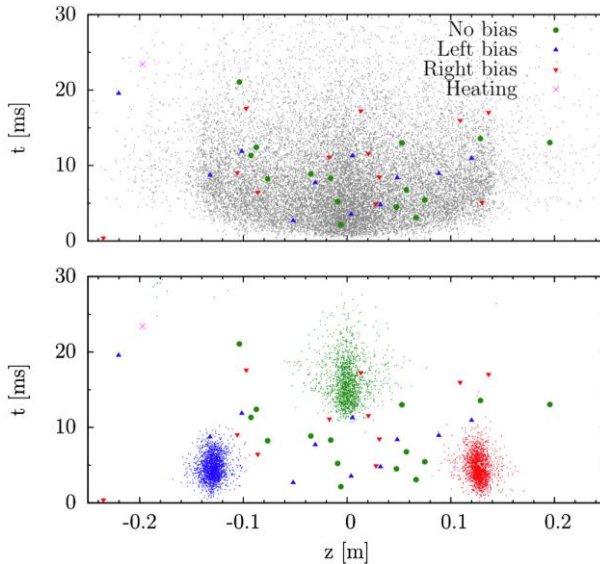

AARHUS UNIVERSITY



Spectroscopy Laser

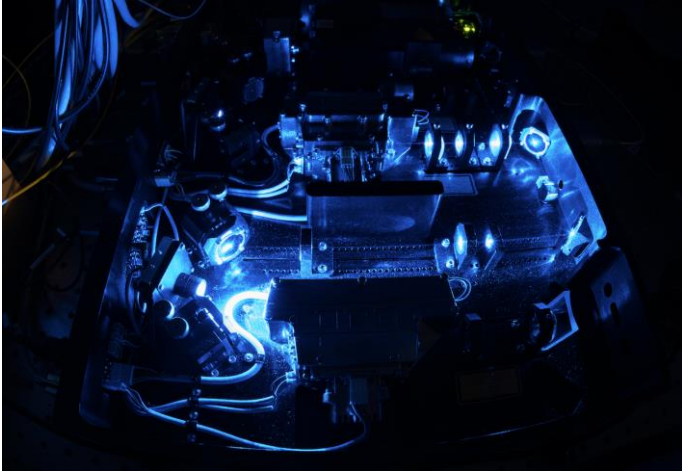

AARHUS UNIVERSITY

