

# The **CLOUD** experiment

## Cosmics Leaving Outdoor Droplets

Hanna Manninen, PhD  
CLOUD Run Coordinator

Studies the influence of  
galactic cosmic rays on aerosols and clouds,  
and their implications for climate





**What is in common with the cloud chamber tracks and the air plane contrails?**



# The collaboration is atmospheric scientists... and CERN:

*Aerodyne Research Inc., Billerica, Massachusetts 01821, USA*

*California Institute of Technology, Div. of Chemistry & Chemical Engineering, Pasadena, California 91125, USA*

*Carnegie Mellon University, Center for Atmospheric Particle Studies, Pittsburgh PA 15213-3890, USA*

*CERN, CH-1211 Geneva, Switzerland*

*Finnish Meteorological Institute, FI-00101 Helsinki, Finland*

*Goethe-University of Frankfurt, Institute for Atmospheric and Environmental Sciences, 60438 Frankfurt am Main, Germany*

*Helsinki Institute of Physics, University of Helsinki, FI-00014 Helsinki, Finland*

*Karlsruhe Institute of Technology, Institute for Meteorology and Climate Research, 76344 Eggenstein-Leopoldshafen, Germany*

*Lebedev Physical Institute, Solar and Cosmic Ray Research Laboratory, 119991 Moscow, Russia*

*Leibniz Institute for Tropospheric Research, 04318 Leipzig, Germany*

*Paul Scherrer Institute, Laboratory of Atmospheric Chemistry, CH-5232 Villigen, Switzerland*

*TOFWERK AG, CH-3600 Thun, Switzerland*

*University of Eastern Finland, Department of Applied Physics, FI-70211 Kuopio, Finland*

*University of Helsinki, Department of Physics, FI-00014 Helsinki, Finland*

*University of Innsbruck, Institute for Ion and Applied Physics, 6020 Innsbruck, Austria*

*University of Leeds, School of Earth and Environment, LS2-9JT Leeds, UK*

*University of Lisbon and University of Beira Interior, 1749-016 Lisbon, Portugal*

*University of Manchester, School of Earth, Atmospheric and Environmental Sciences, Manchester M13 9PL, UK*

*University of Stockholm, Department of Applied Environmental Science, 10691 Stockholm, Sweden*

*University of Vienna, Faculty of Physics, 1090 Vienna, Austria*



**Why do atmospheric  
scientists come to  
CERN?**

Andri Pol

# Climate is already changing: global surface temperature change since 1850

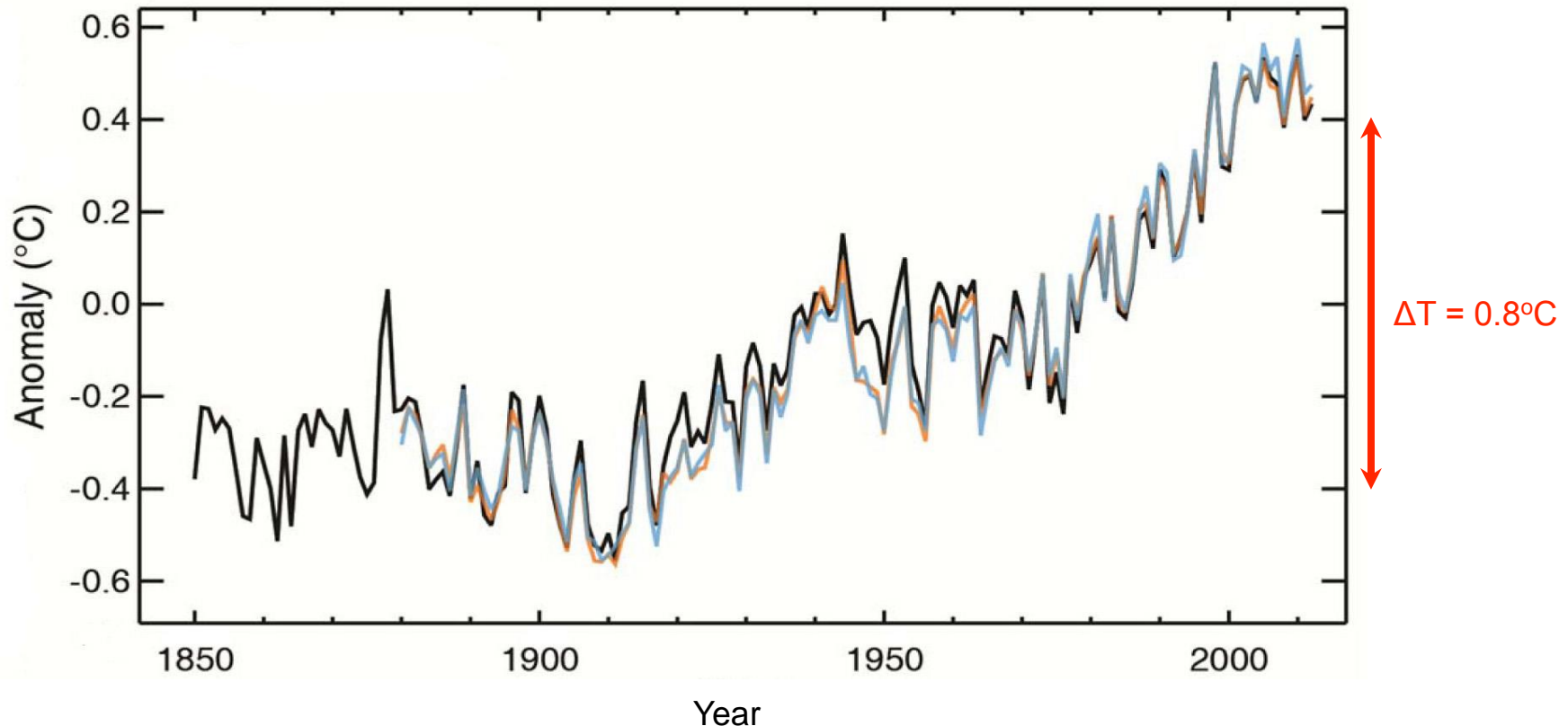

Source: IPCC, Summary for Policymakers, 2013

**WHAT WILL HAPPEN WITHIN NEXT 40-50 YEARS?**



# MOTIVATION: COSMIC RAYS, AEROSOLS AND CLOUDS

# Aerosol particles: what are they?

Definition: Suspension of small (liquid or solid) particles in a gas

**Ammonium sulphate: 10 - 100 nm**

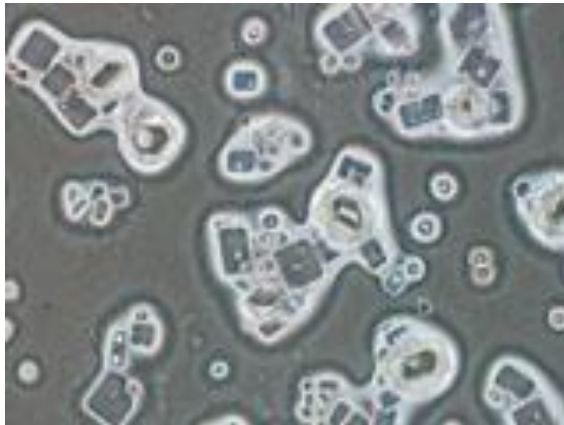

**Diesel soot: ca. 100 nm**

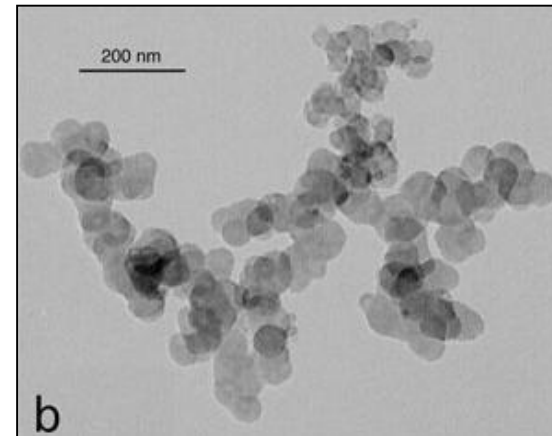

**Sea salt: 0.2 - 10  $\mu\text{m}$**

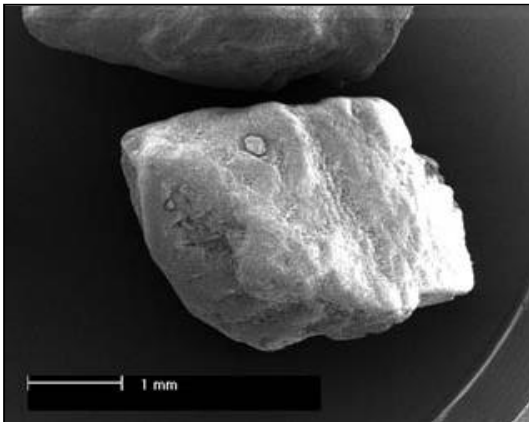

**Mineral dust: 0.2 - 10  $\mu\text{m}$**

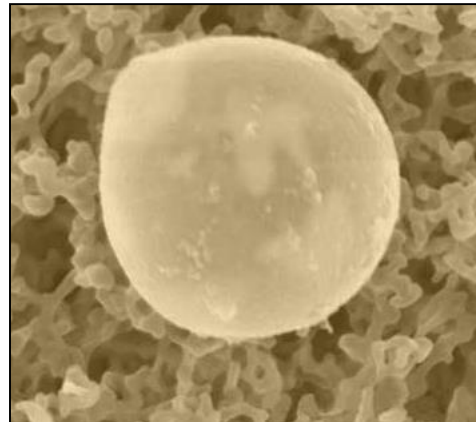

**Pollen: 10 - 100  $\mu\text{m}$**

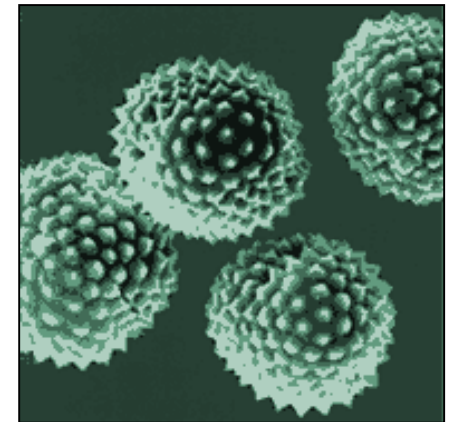



**PRIMARY** (directly produced)  
**ATMOSPHERIC AEROSOLS**



**SECONDARY AEROSOLS**  
(indirectly produced, gas-to-particle conversion i.e. nucleation)



**About half  
of climate-  
relevant  
particles**

**Primary** particles are emitted globally:

<https://www.youtube.com/watch?v=YtJzn8A725w>



**Blue:** sea salt blown by the wind

**Green:** Carbon from fires (black carbon i.e. soot)

**White:** sulfates from fossil fuels and volcanos (antropogenic vs. natural)

**Orange/red:** dust

2006-08-19 18:00

## Primary aerosol production: direct emissions

Blue: sea salt blown by  
the wind

Green: Carbon from  
fires (black carbon i.e.  
soot)

White: sulfates from  
fossil fuels and  
vulcanos (antropogenic  
vs. natural)

Orange/red: dust



10-km GEOS-5 Aerosol Optical Depth

Dust | Organic & Black Carbon | Sulfates | Sea Salt

Global Modeling and Assimilation Office - William.M.Putman@nasa.gov



<https://www.youtube.com/watch?v=YtJzn8A725w>

# Secondary aerosol source: gas to particle conversion

Gas phase precursors

Particle formation by nucleation

Enhanced growth by condensation and coagulation

## Aerosol-cloud interaction:

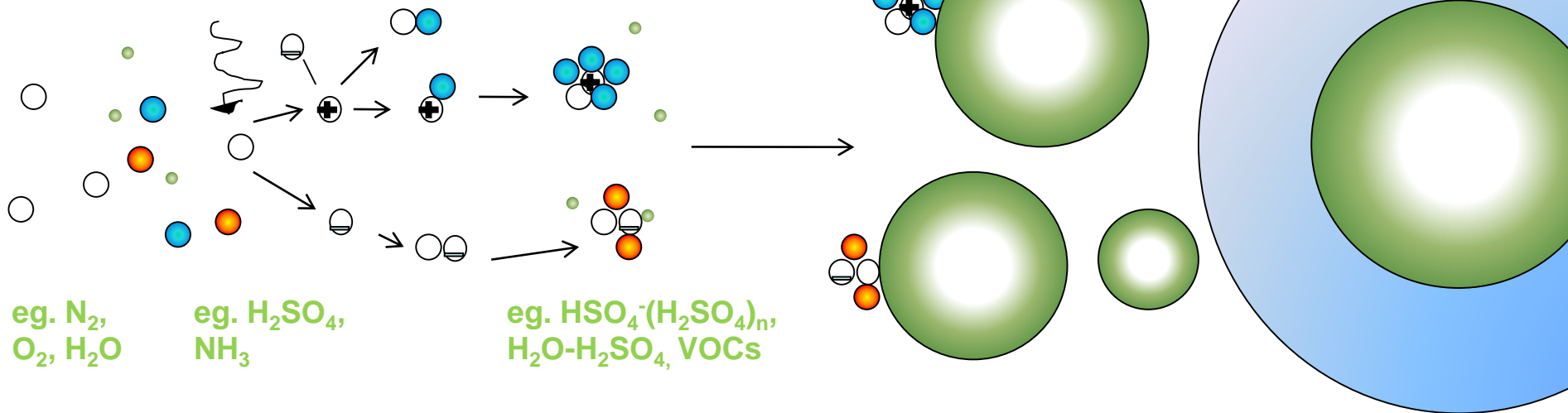

Gas	Molecules	Cluster ions and neutral clusters	Particles	Cloud condensation nuclei (CCN)
	< 1nm	~1-3 nm	> 3 nm	> 100 nm

# CLOUD simulates real atmosphere

12 consecutive particle formation event days 8–19  
April 2007 in Hyytiälä, Finland

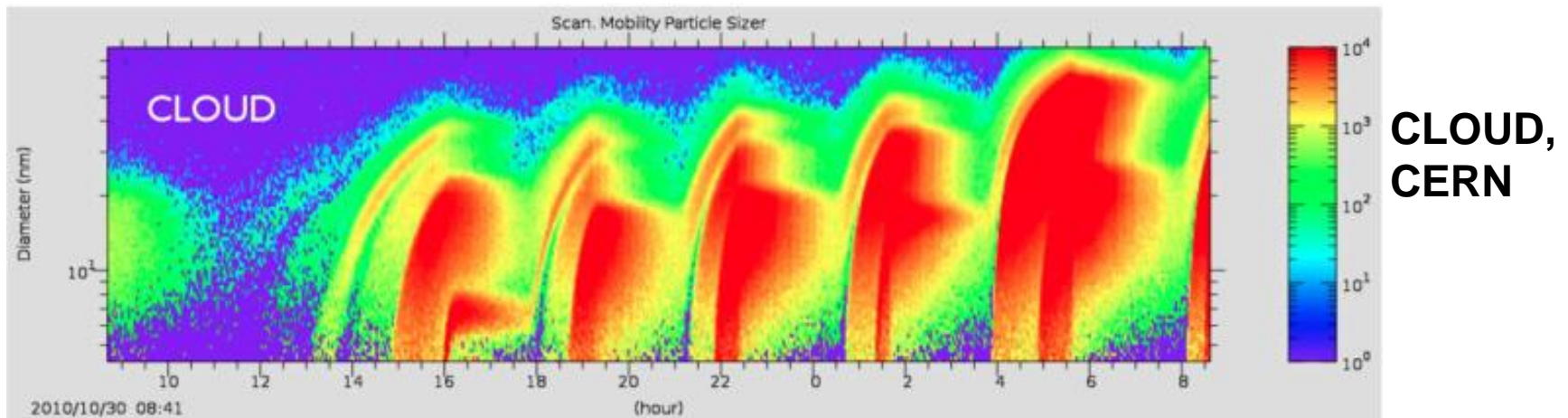
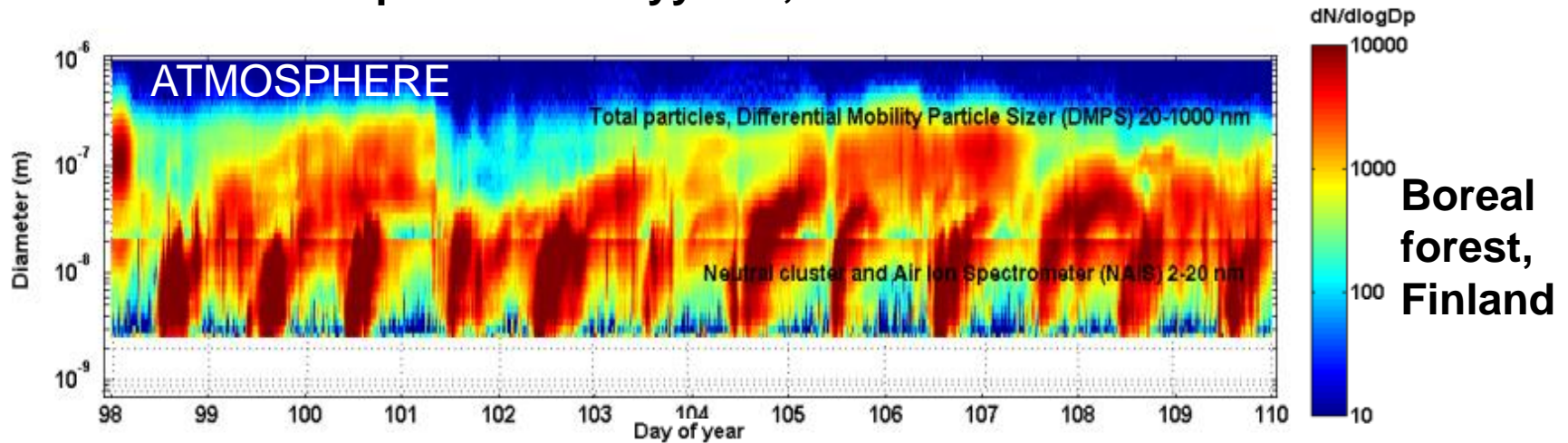



CONDENSATORS	7
COAGULATORS	6

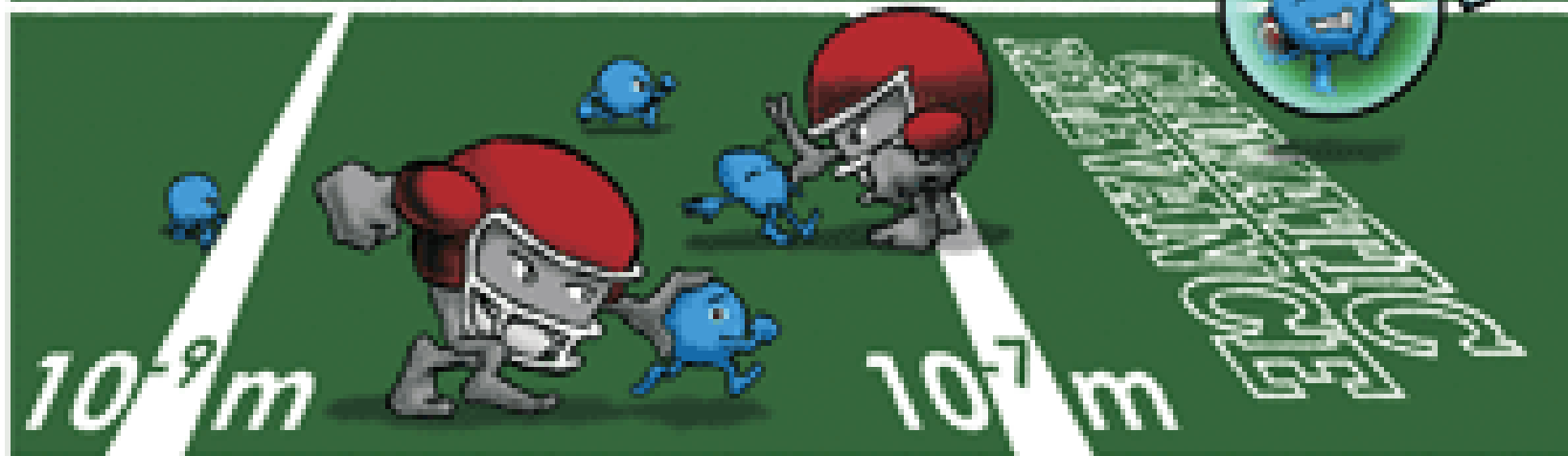
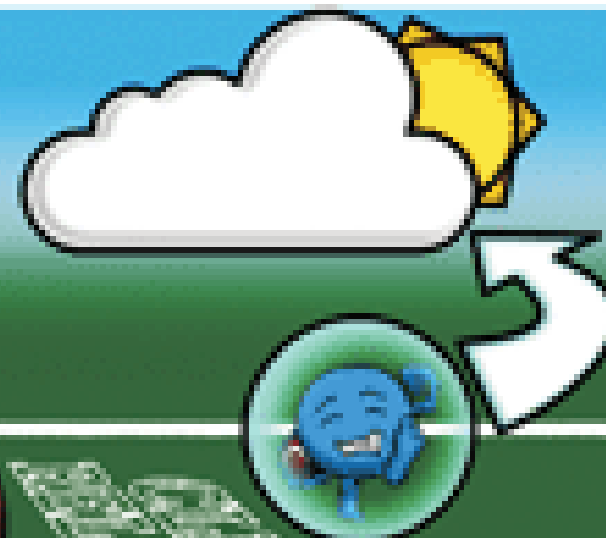

**Thermodynamics and kinetics of atmospheric aerosol particle formation  
and growth**

Hanna Vehkamäki and Ilona Riipinen, 2012

These natural aerosols i.e. secondary particles are formed via new particle formation.

Newly formed particles need to grow all the way to cloud droplets to affect **global climate**.

# Scientific understanding of climate radiative forcing in Industrial Age

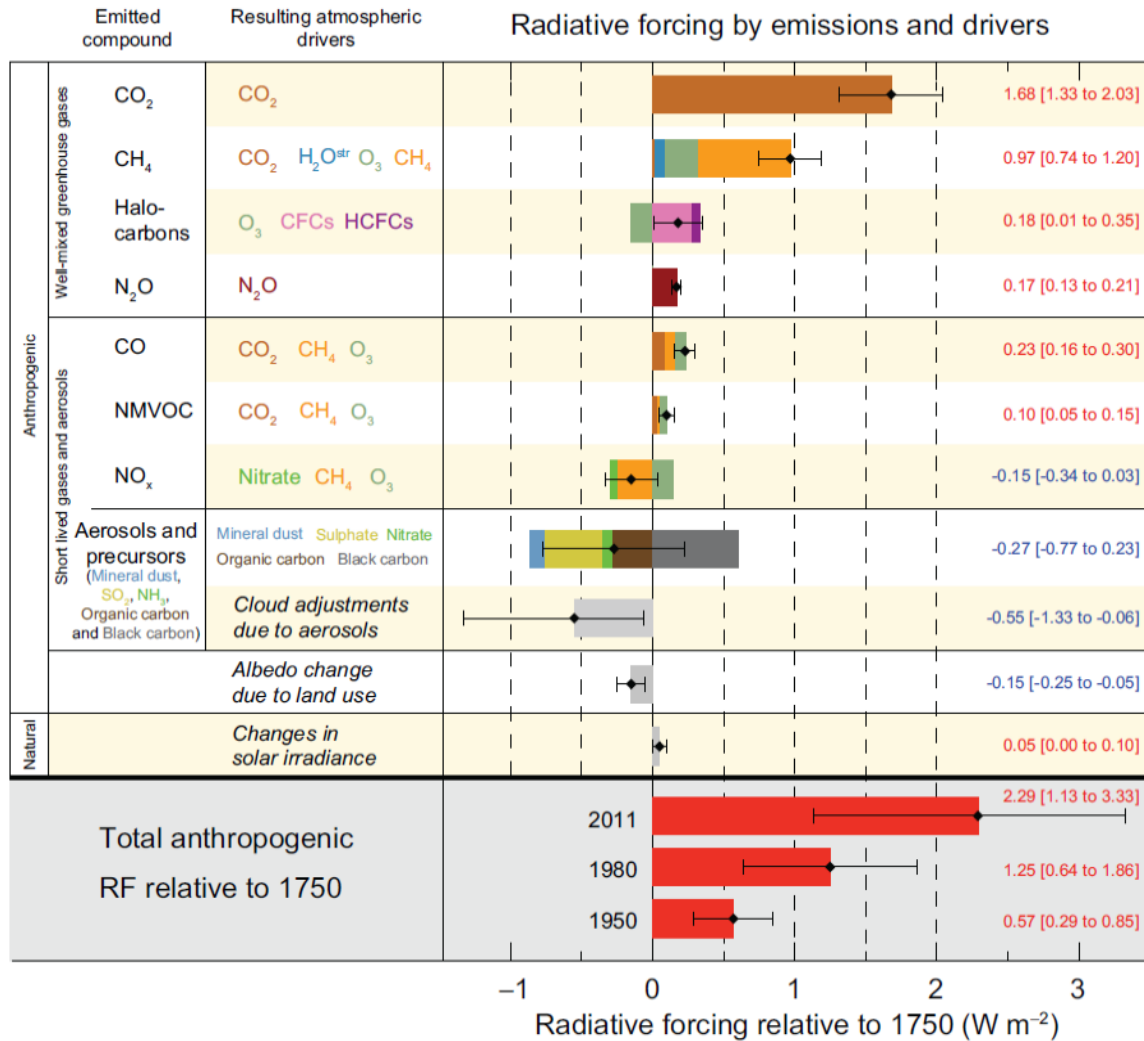

- A. Anthropogenic aerosol forcing are poorly understood.
- B. Natural part is very small. Is there a missing natural forcing? Is that from varying cosmic ray flux, modulated by sun?

Source: IPCC, Summary for Policymakers, 2013

A + B → The CLOUD experiment



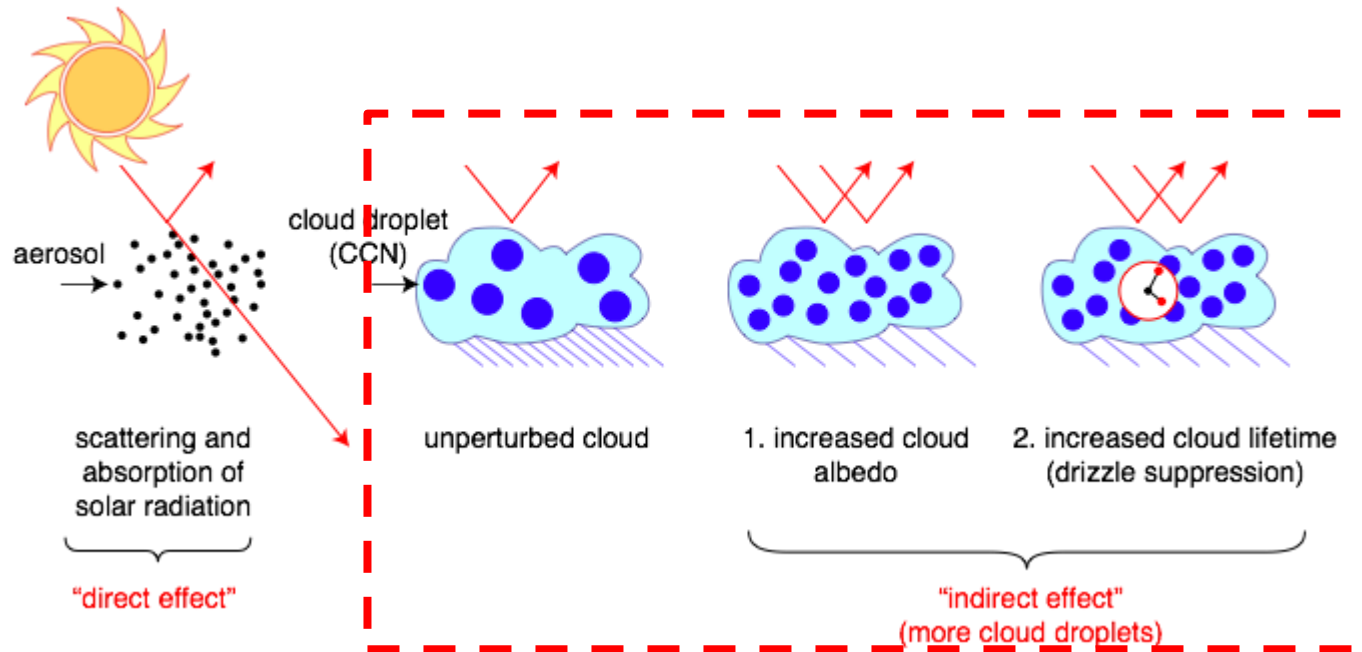

- **All cloud droplets form on aerosol “seeds” known as cloud condensation nuclei - CCN**
- Cloud properties are sensitive to number of droplets
- More aerosols/CCN:
  - Brighter clouds, with longer lifetimes
- **Sources of atmospheric aerosols:**
  - Primary (dust, sea salt, fires)
  - Secondary (gas-to-particle conversion)

See youtube: “No particles no fog” <https://www.youtube.com/watch?v=EneDwu0HrVg>

# CLOUD IN A BOTTLE

**Cool Science Experiment:**

**<https://www.youtube.com/watch?v=msSVQ903T8k>**



# **CLOUD EXPERIMENT: CONCEPT, METHODS, RESULTS**

# WHY ARE WE AT CERN?

- Secondary beam of pions from the CERN PS (3.5 GeV/c ); spanning the galactic cosmic-ray intensity range from ground level to the stratosphere
- Study the effect of cosmic rays on aerosols and clouds, under precisely controlled laboratory conditions.

# Ions enhance aerosol nucleation and growth: how much?

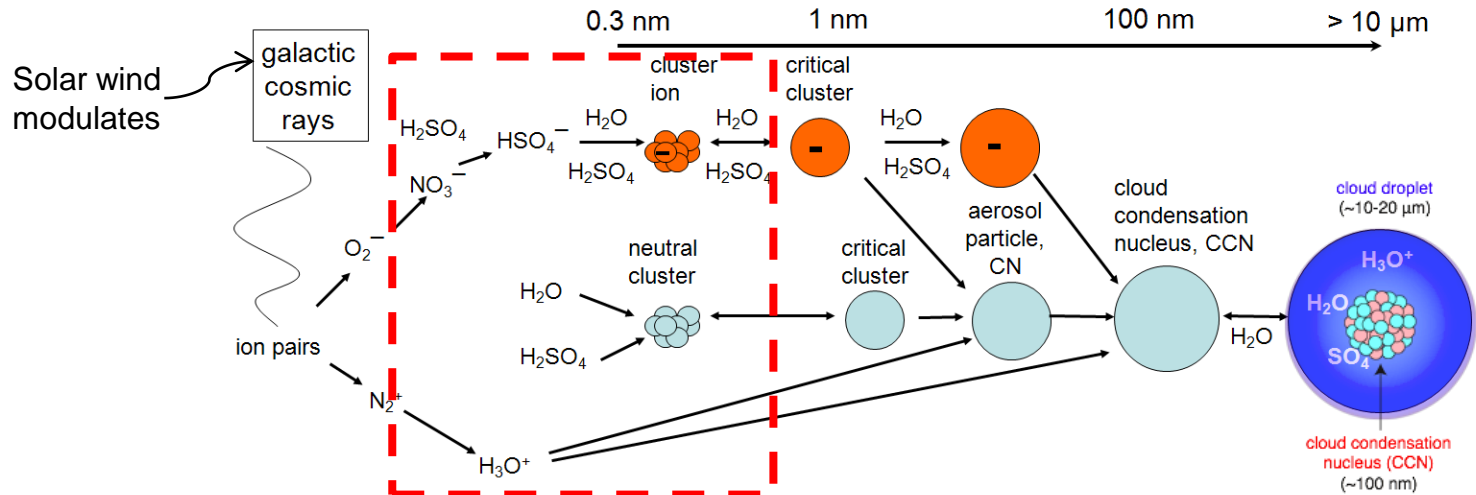

- **Trace condensable vapour** → **CN** → **CCN**
- **But contributing vapours and nucleation rates poorly known**
- H<sub>2</sub>SO<sub>4</sub> is thought to be the primary condensable vapour in atmosphere (sub ppt)
- **Ion-induced nucleation** pathway is energetically favoured but limited by the ion production rate and ion lifetime

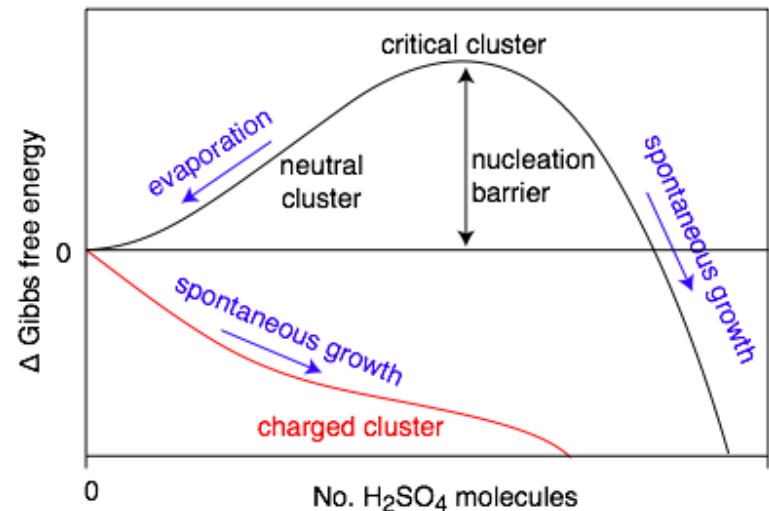



# CLOUD is using CERN Proton Synchrotron PS-T11 beam



**Here!**

# CERN PS-T11: control of the 'cosmic ray' beam intensity

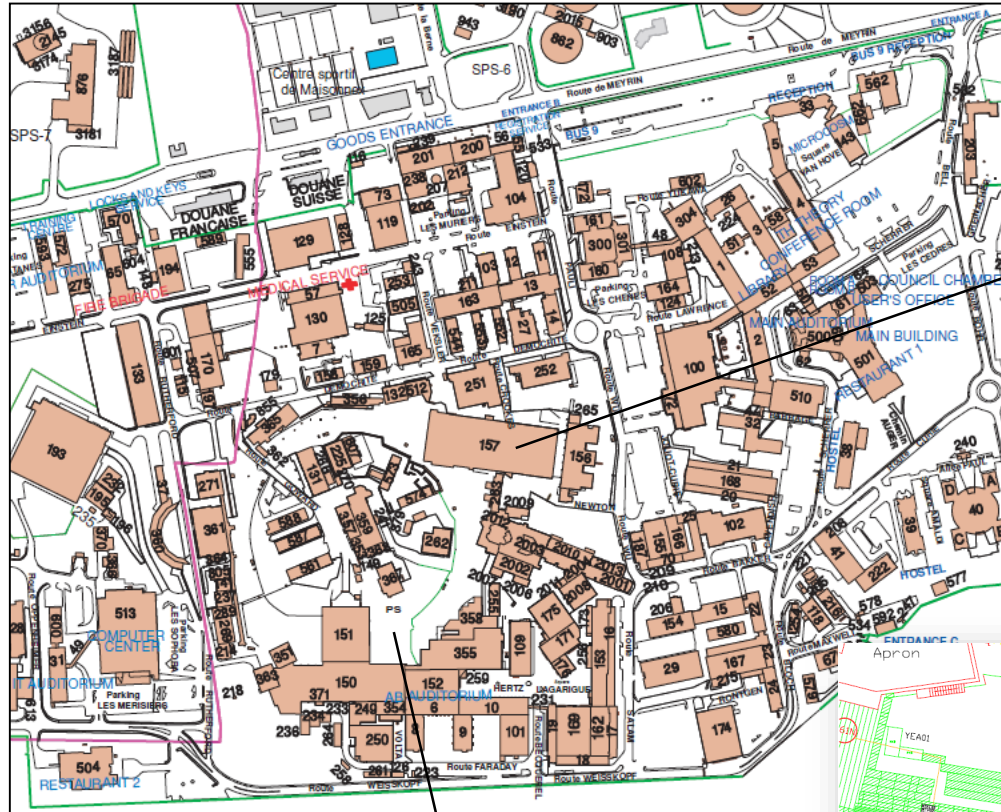

PS East Hall

T11 beam area  
(3.5 GeV/c)

Proton Synchrotron (PS)  
accelerator,  
first operation in 1959

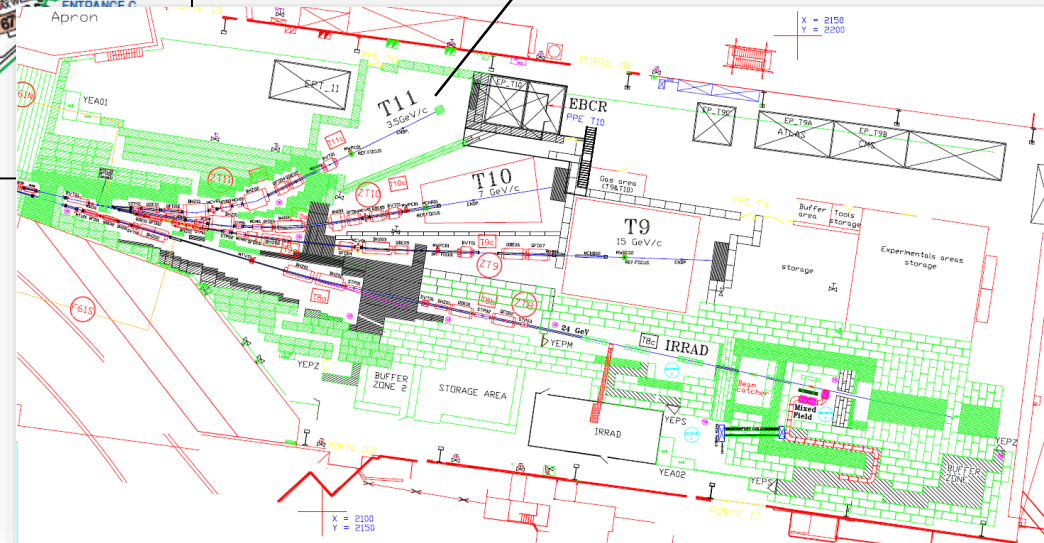

# CLOUD chamber was build in 2009 and is located in T11 beam area:

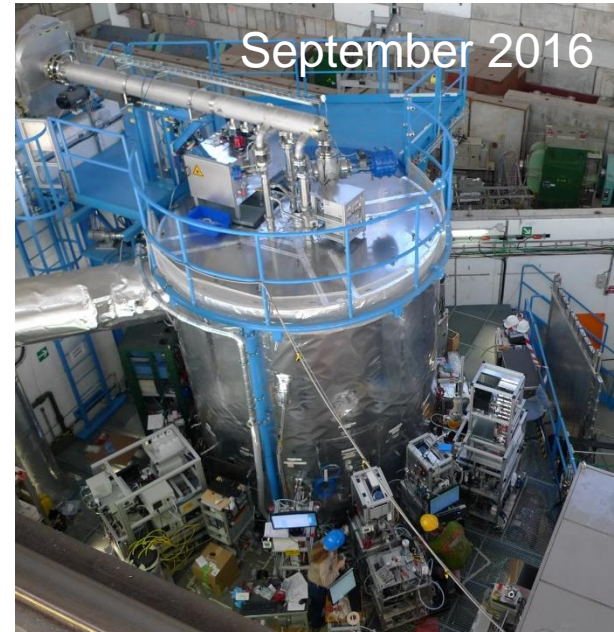



# The core of the experiment is a stainless steel chamber (26m<sup>3</sup>) filled with synthetic air



- Pressure: Atmospheric  $\pm$  0.3 bar
- Only metallic seals
- Electropolished inner surfaces

# World's cleanest laboratory for studies of atmospheric particle formation

**CLOUD is run under precisely controlled laboratory conditions:**

- temperature stability:  $<0.1^{\circ}\text{C}$
- temperature range:  $-90^{\circ}\text{C}$  to  $+30^{\circ}\text{C}$ ; cleaning at  $+100^{\circ}\text{C}$
- surface cleanliness:  $<10$  pptv<sup>\*)</sup> organics contamination, stainless steel (and gold), no teflon, no O-rings
- ultrapure gas supplies
- UV system: negligible heat load by use of fibre optics.
- field cage 30 kV/m

**Unique and highly advanced aerosol chamber already as such!**

<sup>\*)</sup> pptv = part per trillion,  $1 / 10^{12}$



# CLOUD set-up: instruments connected to sampling probes

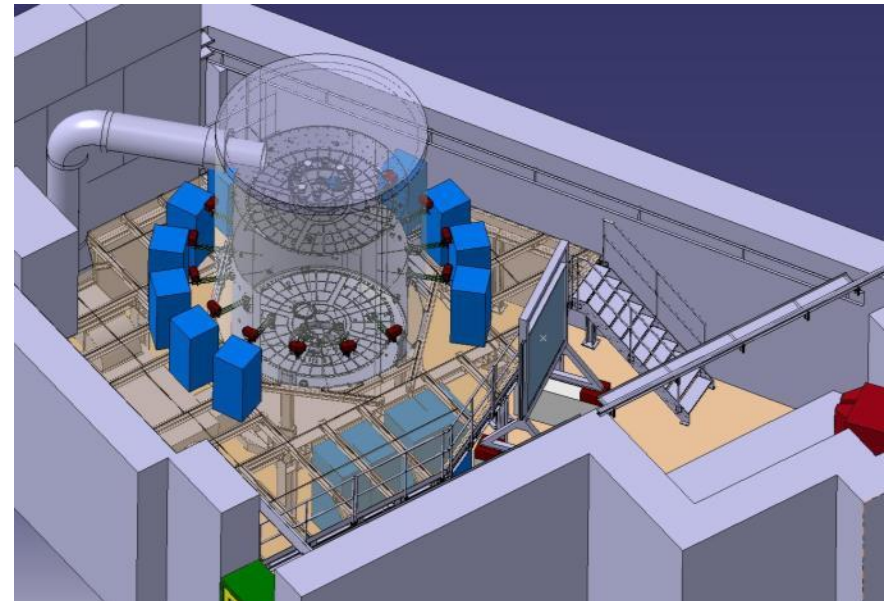
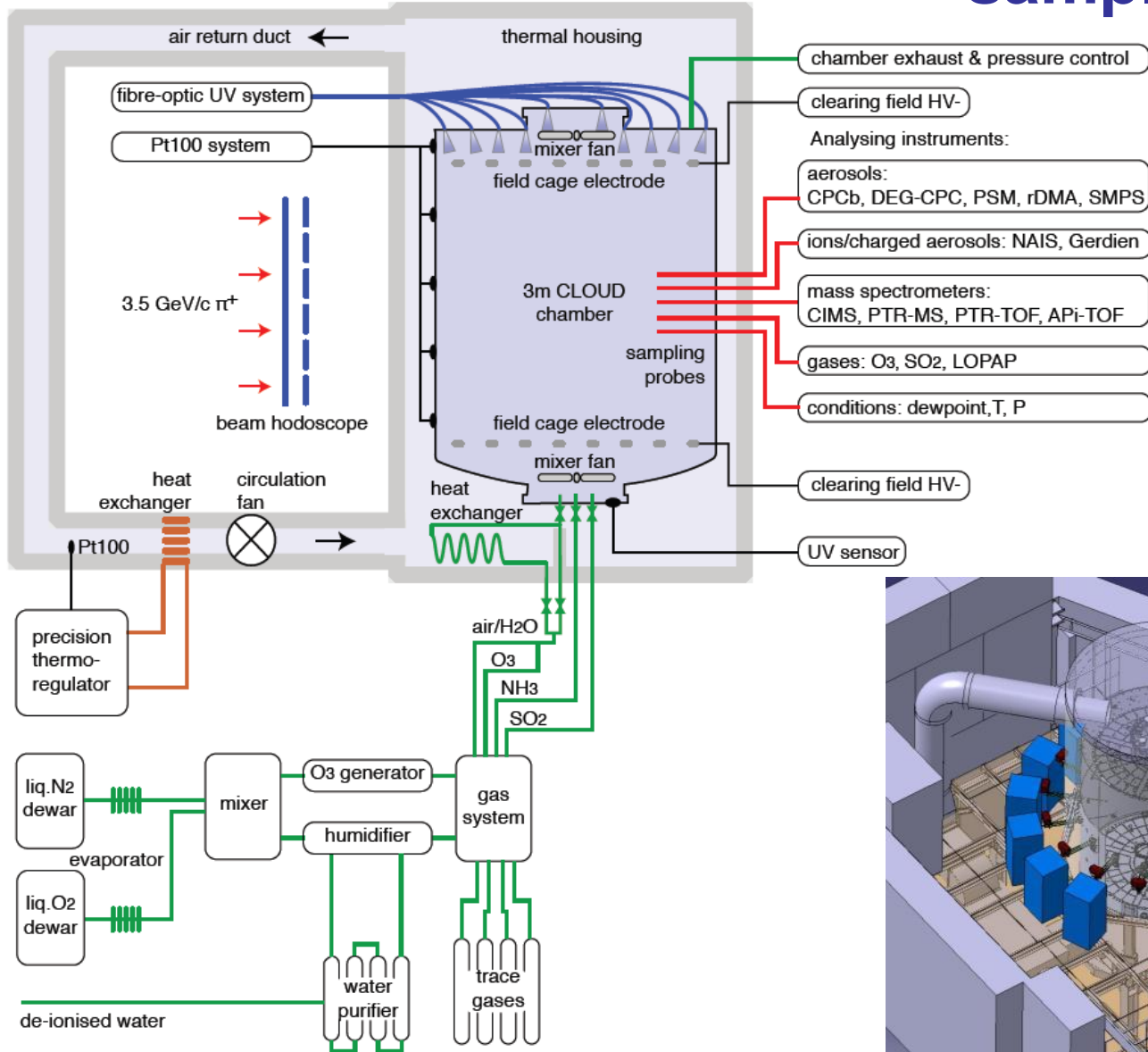

# Ultra-pure air: synthetic air made from liquid nitrogen and liquid oxygen

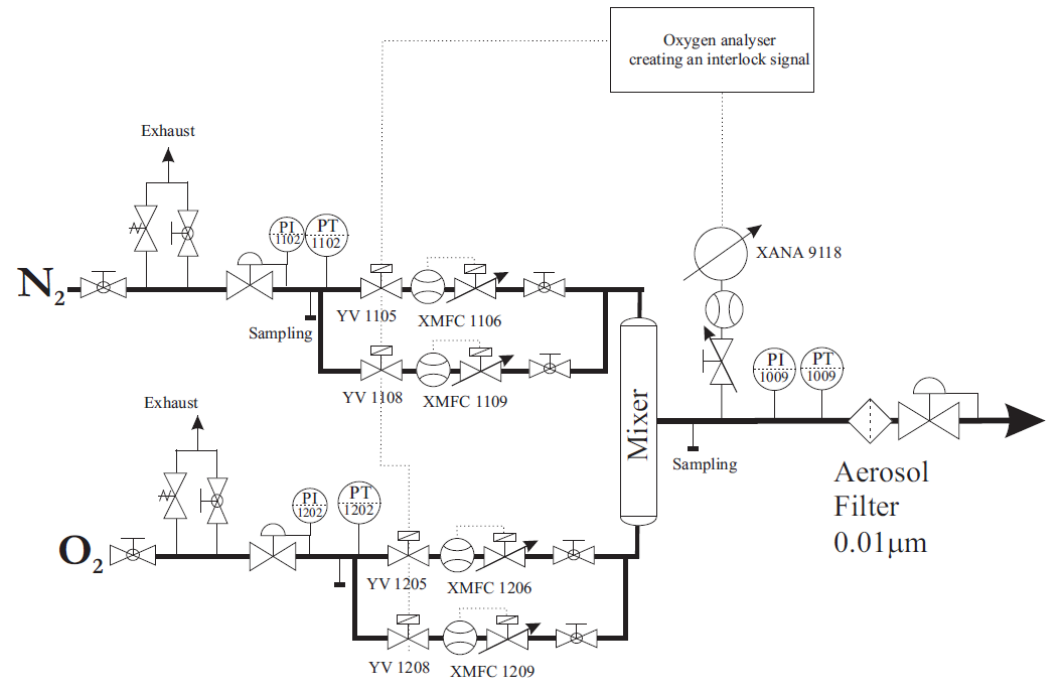

# Gas system built to the highest technical standard of performance

## CLD-09 Distribution

1/10/2009, S.Haider

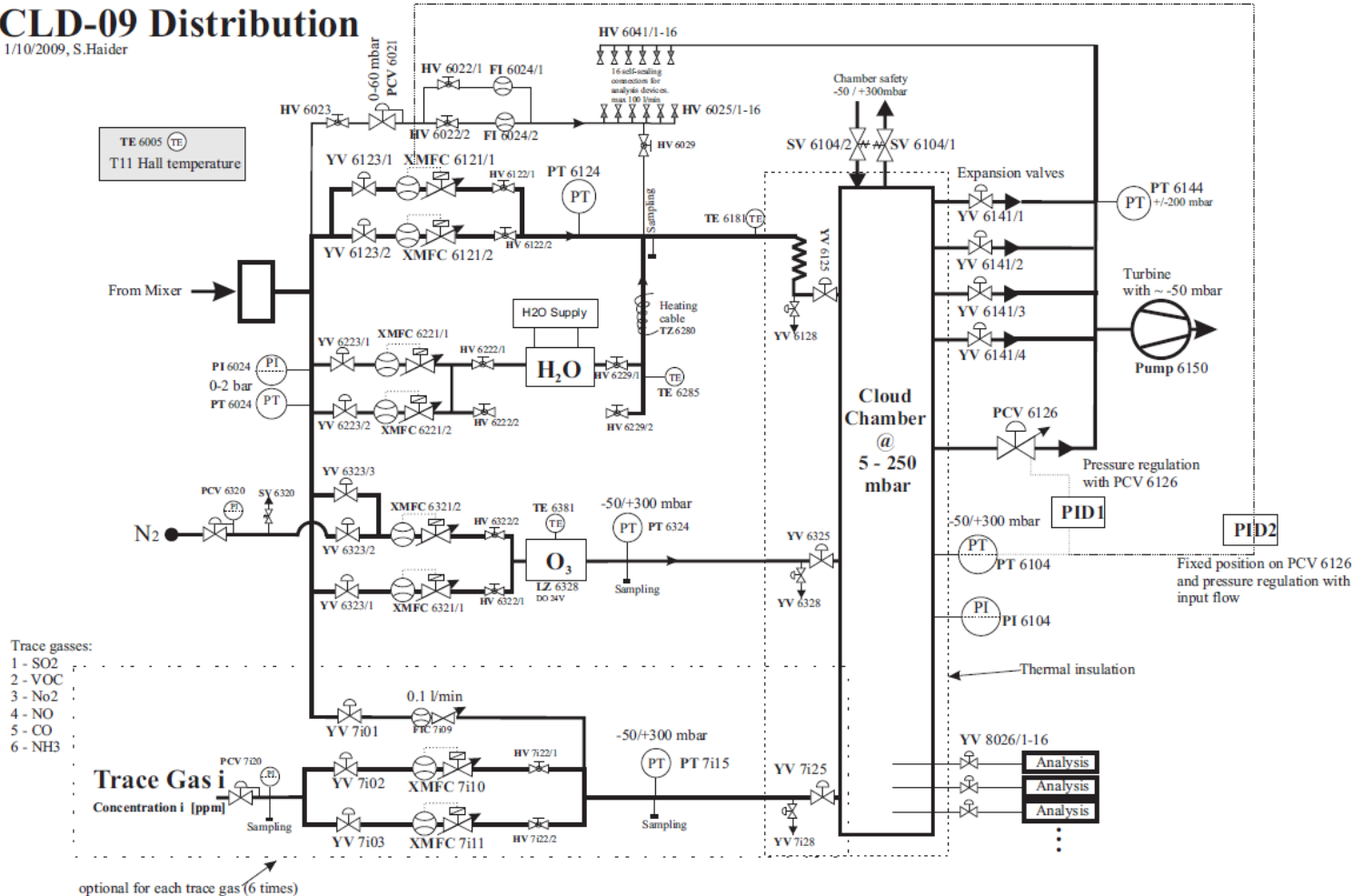

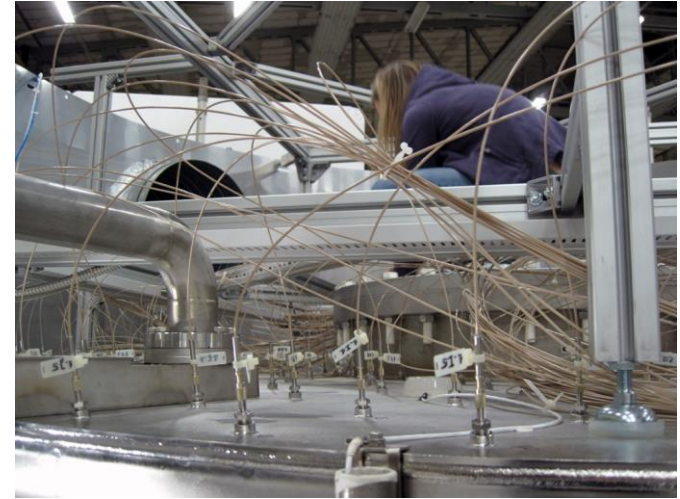

Precise and uniform adjustment of the  $\text{H}_2\text{SO}_4$  concentration by means of UV laser system for the homogeneous, in-situ generation of the precursor gases

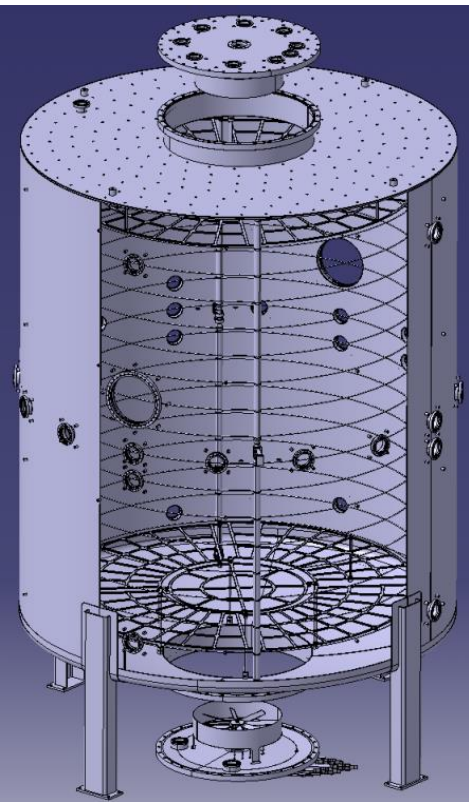

To study neutral nucleation, the beam is turned off and an internal electric field of up to 20 kV/m is applied by means of two transparent field cage electrodes. This rapidly (in about 1 s) sweeps out the background ions produced by galactic cosmic rays.



# Metallic fan mixing rapidly the fresh gas and ions generated by the pion beam



The fans produce a counter-flow inside the chamber, and ensure good uniformity.



# Thermal system enables highly stable operation at any temperature (300-183 K)

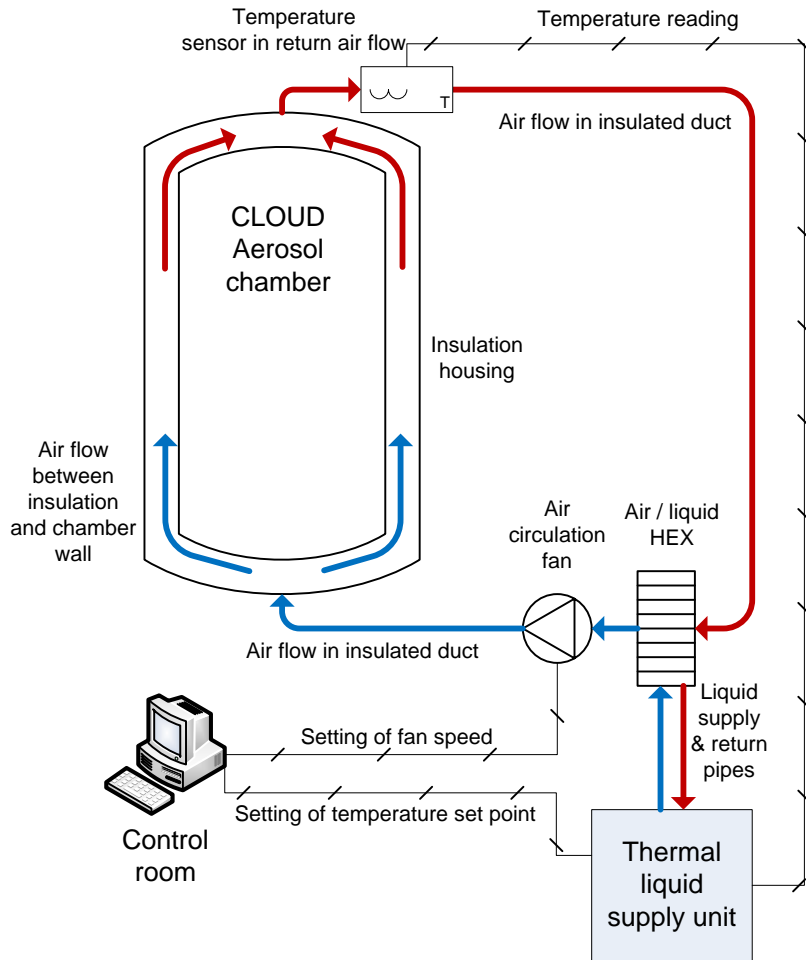

# How to build up a CLOUD run?

1. Fill chamber with clean air + water vapour

2. Set temperature and pressure

3. Add trace gases, condensable species in atmospheric, extremely low concentrations  
~1 molecule in  $10^{12}$  air molecules

4. Expose to ionizing beam, and possibly to UV-light

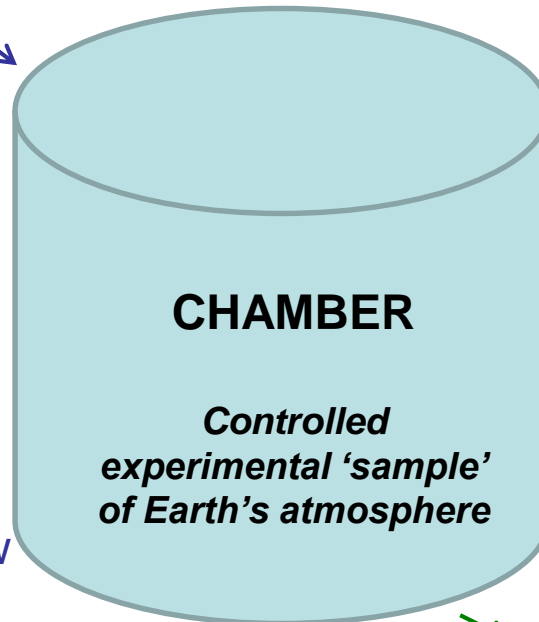

7. Carefully flush the chamber and clean the chamber walls between experiments

6. Repeat experiment (typically some hours), possibly with varying parameters

## 5. Observe

- Particle growth size distribution
- Electrical charge distribution
- Cloud droplet/ice particle concentrations,
- etc.

# CLOUD run: instruments sampling from chamber and recording continuously

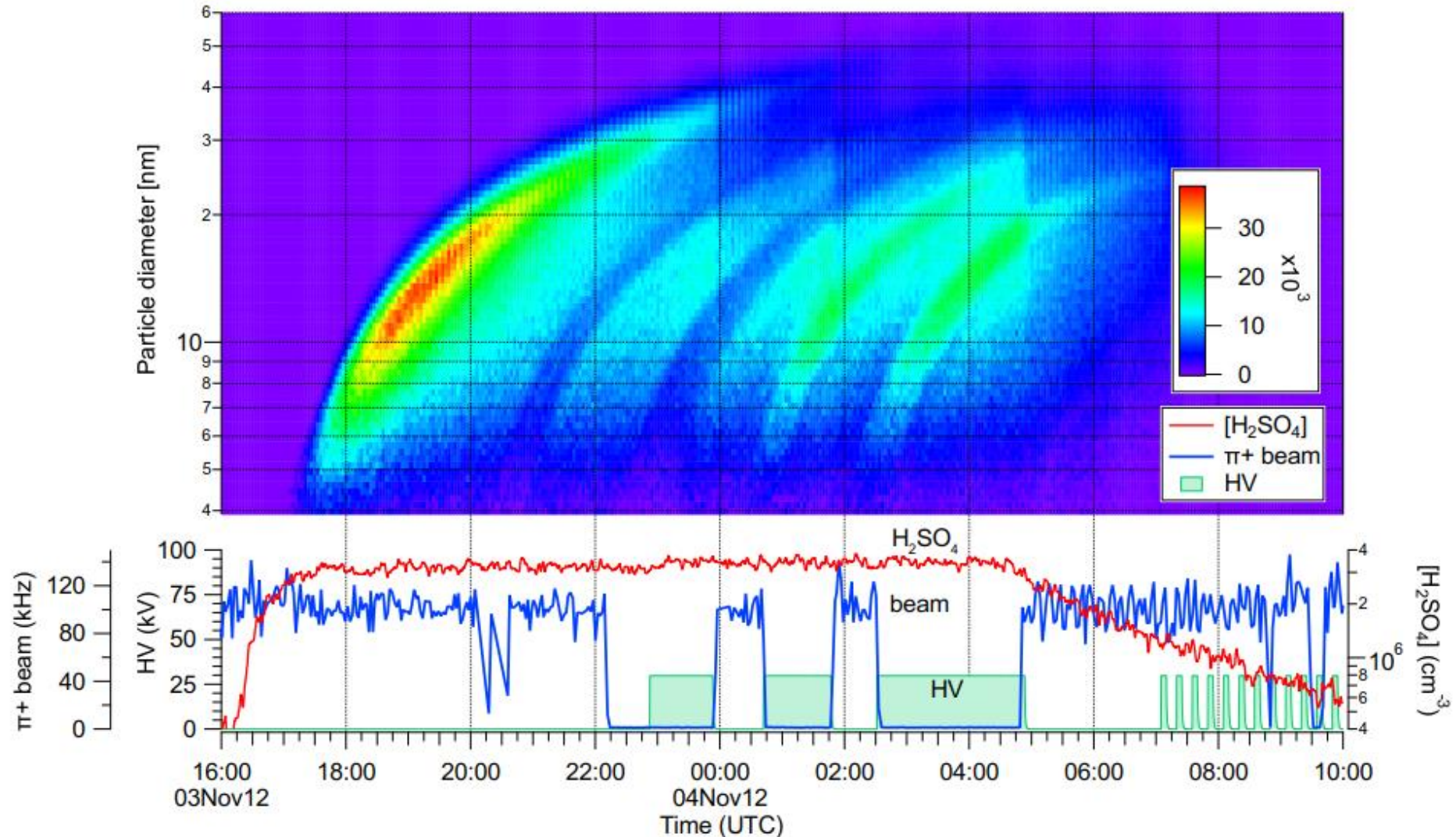

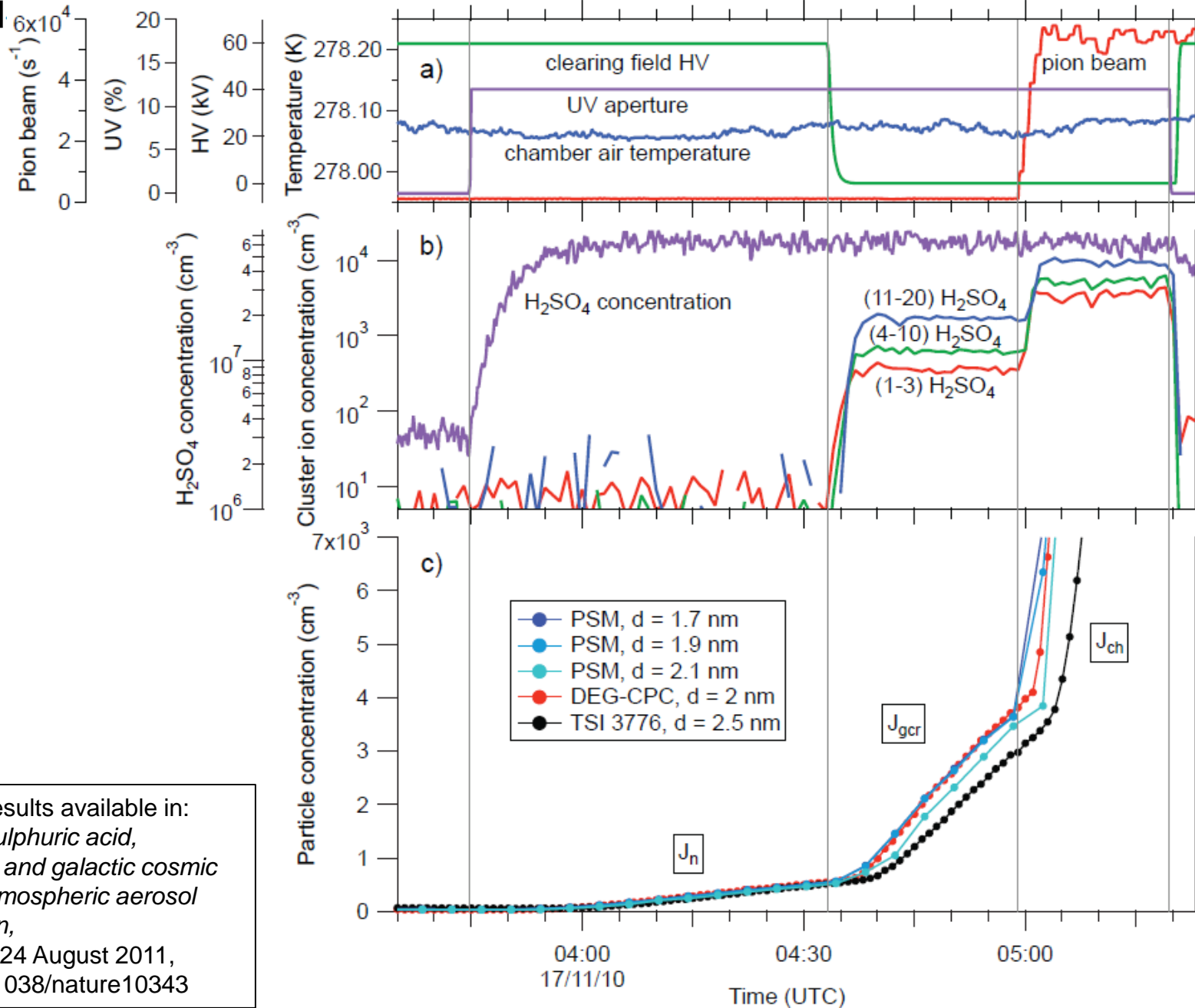

Further results available in:  
*Role of sulphuric acid,  
 ammonia and galactic cosmic  
 rays in atmospheric aerosol  
 nucleation,*  
 nature, 24 August 2011,  
 doi:10.1038/nature10343

# Importance of biogenic aerosol particles

- Huge discovery that **biogenic vapours emitted by trees** and oxidised in the atmosphere have a significant impact on the formation of clouds, *thus helping to cool the planet*
- Addition DMA into system brings the nucleation rate into the range of atmospheric observations

Nearly all nucleation throughout the present-day atmosphere involves ammonia or biogenic organic compounds, in addition to sulfuric acid

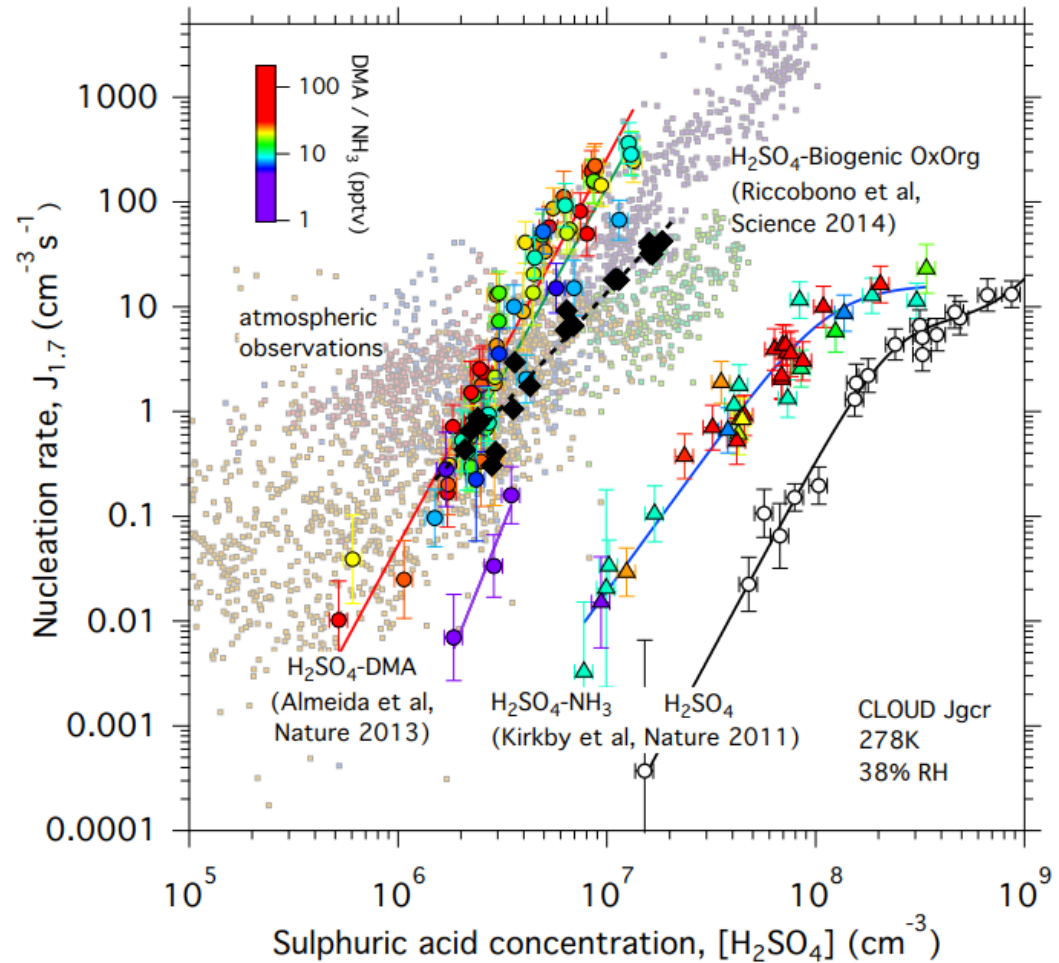

# Global importance of nucleation using global aerosol models

*Parametrizations of nucleation from H<sub>2</sub>SO<sub>4</sub>/NH<sub>3</sub> + H<sub>2</sub>SO<sub>4</sub>/Biogenic + Pure biogenic + ions experiments*

## Pre-industrial nucleation fraction

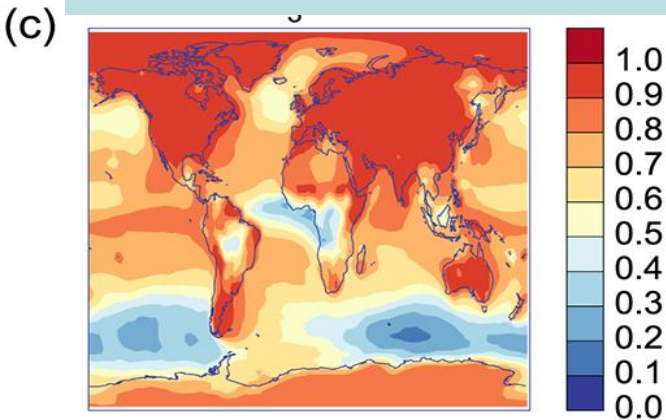

**65% (45-84%)**

## Present day nucleation fraction

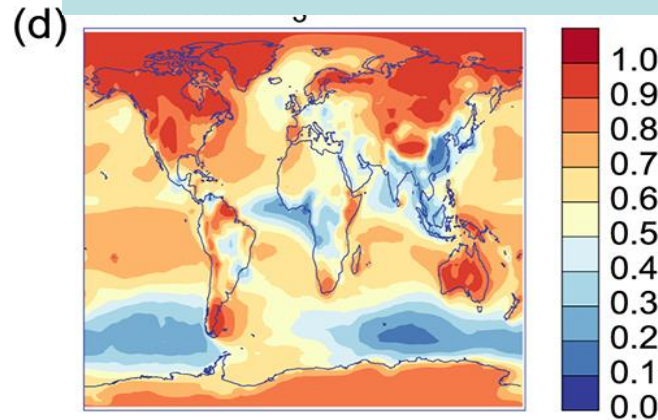

**55% (39-66%)**

65% of climate-relevant aerosol particles in the preindustrial atmosphere come from nucleation, and 55% today

Gordon et al. Causes and importance of new particle formation in the present-day and preindustrial atmospheres, JGR 2017

# How is the experimental data from CLOUD connected to our daily lives?

- Within the CLOUD experiment **both measurements and modelling** are needed for assessing connection between aerosols, clouds and climate

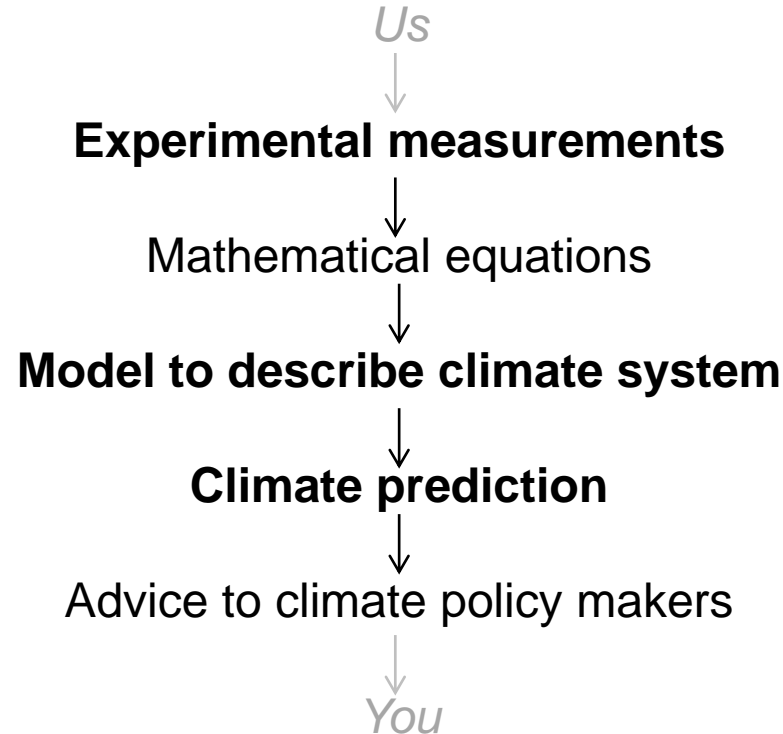

# CLOUD with the measurement instruments and their users during a campaign

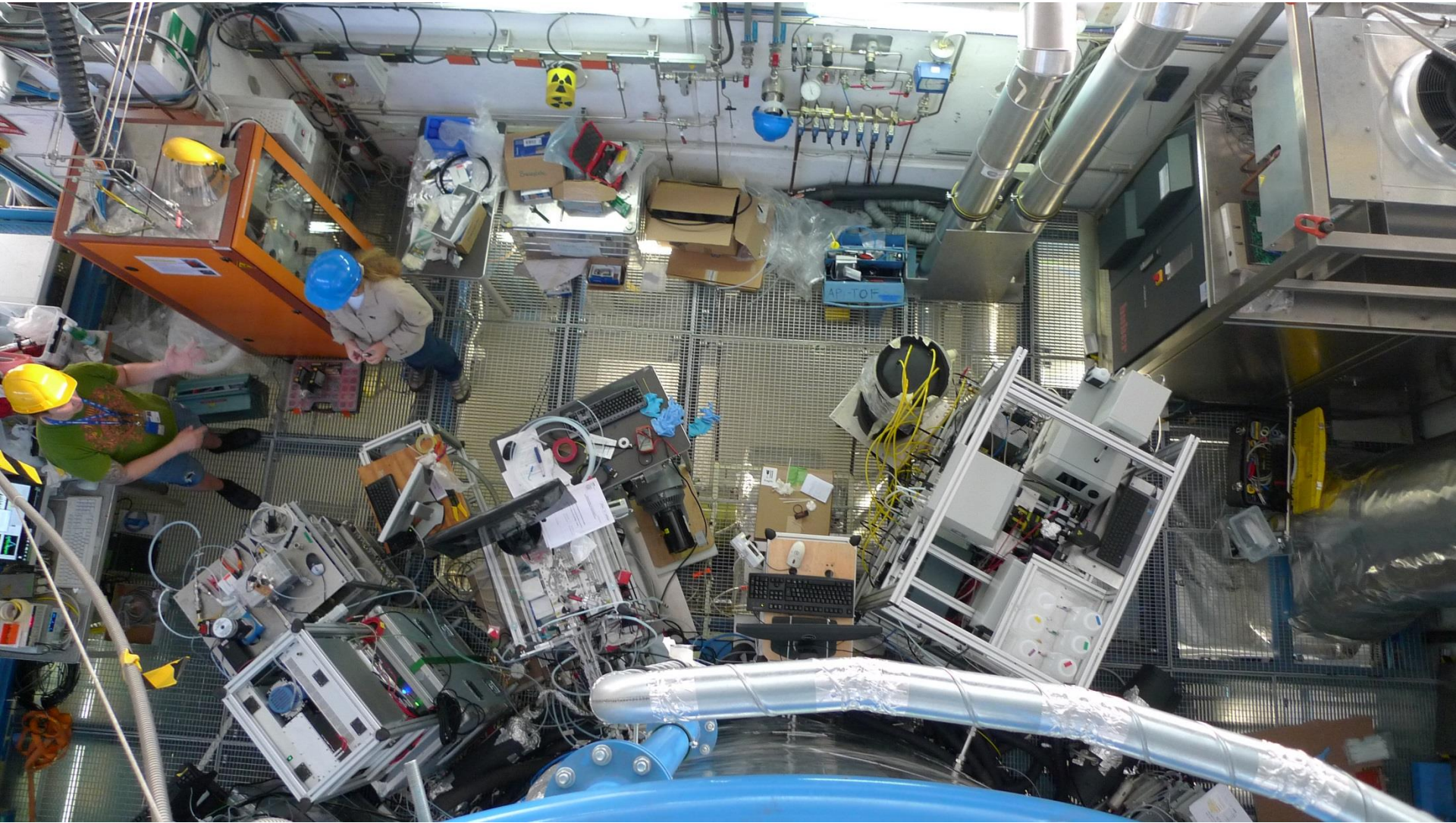



# State-of-the-art gas and aerosol analysis instruments from collaborating institutes:

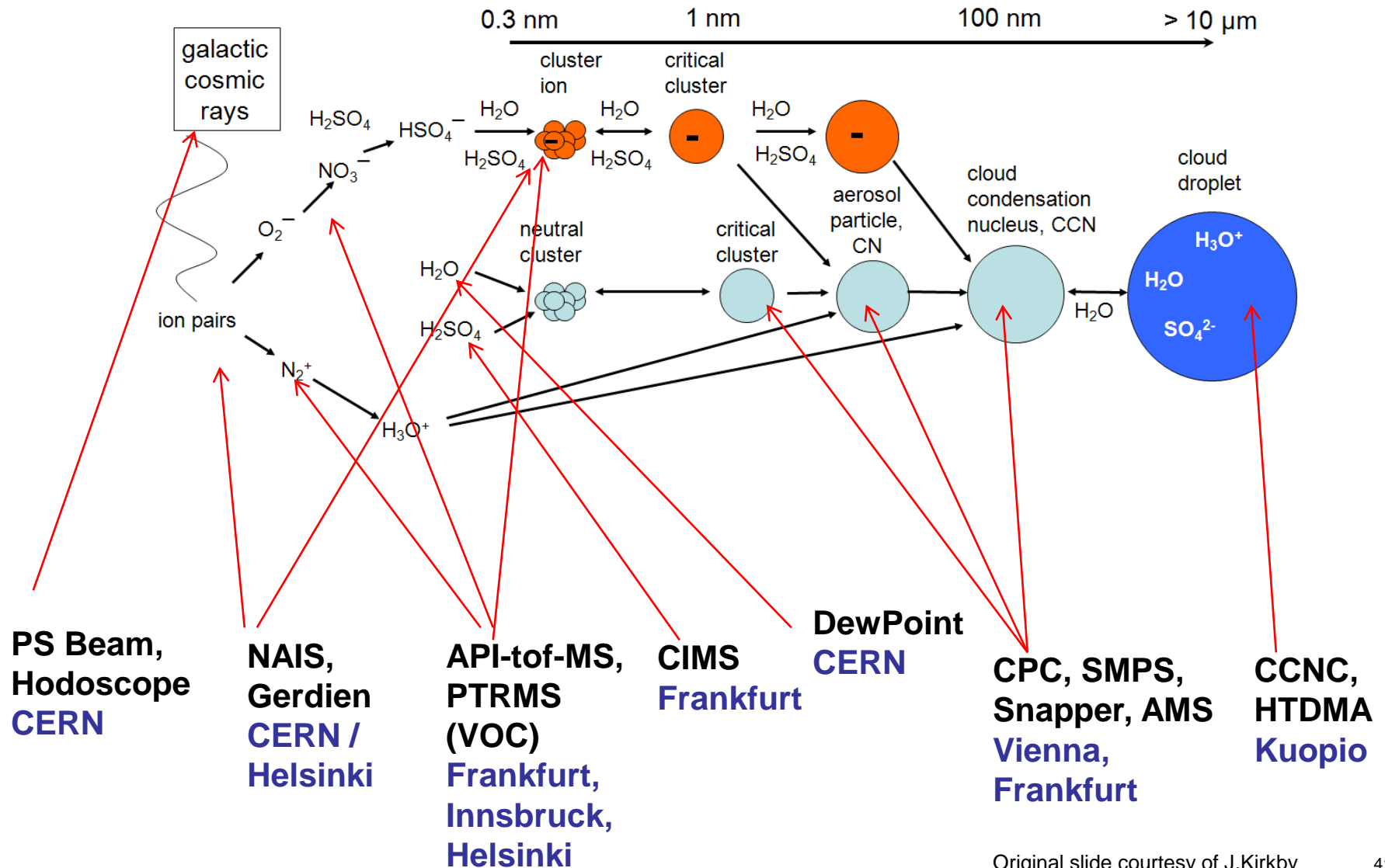



# Results from CLOUD

First major publication  
5 years after CLOUD  
approved in CERN  
programme,  
2 years after first run



## LETTER

25 AUGUST 2011 | VOL 476 | NATURE | 429

doi:10.1038/nature10343

### Role of sulphuric acid, ammonia and galactic cosmic rays in atmospheric aerosol nucleation

Jasper Kirkby<sup>1</sup>, Joachim Curtius<sup>2</sup>, João Almeida<sup>2,3</sup>, Eimear Dunne<sup>4</sup>, Jonathan Duplissy<sup>1,5,6</sup>, Sebastian Ehrhart<sup>2</sup>, Alessandro Franchin<sup>5</sup>, Stéphanie Gagné<sup>5,6</sup>, Luisa Ickes<sup>2</sup>, Andreas Kürten<sup>2</sup>, Agnieszka Kupc<sup>7</sup>, Axel Metzger<sup>8</sup>, Francesco Riccobono<sup>9</sup>, Linda Rondo<sup>2</sup>, Siegfried Schobesberger<sup>5</sup>, Georgios Tsagkogeorgas<sup>10</sup>, Daniela Wimmer<sup>2</sup>, Antonio Amorim<sup>3</sup>, Federico Bianchi<sup>9,11</sup>, Martin Breitenlechner<sup>8</sup>, André David<sup>1</sup>, Josef Dommen<sup>9</sup>, Andrew Downard<sup>12</sup>, Mikael Ehn<sup>5</sup>, Richard C. Flagan<sup>12</sup>, Stefan Haider<sup>1</sup>, Armin Hansel<sup>8</sup>, Daniel Hauser<sup>8</sup>, Werner Jud<sup>8</sup>, Heikki Junninen<sup>5</sup>, Fabian Kreissl<sup>2</sup>, Alexander Kvashin<sup>13</sup>, Ari Laaksonen<sup>14</sup>, Katrianne Lehtipalo<sup>5</sup>, Jorge Lima<sup>3</sup>, Edward R. Lovejoy<sup>15</sup>, Vladimir Makhmutov<sup>13</sup>, Serge Mathot<sup>1</sup>, Jyri Mikkilä<sup>5</sup>, Pierre Minginette<sup>1</sup>, Sandra Mogo<sup>3</sup>, Tuomo Nieminen<sup>5</sup>, Antti Onnela<sup>1</sup>, Paulo Pereira<sup>3</sup>, Tuukka Petäjä<sup>5</sup>, Ralf Schnitzhofer<sup>8</sup>, John H. Seinfeld<sup>12</sup>, Mikko Sipilä<sup>5,6</sup>, Yuri Stozhkov<sup>13</sup>, Frank Stratmann<sup>10</sup>, Antonio Tomé<sup>3</sup>, Joonas Vanhanen<sup>5</sup>, Yrjö Viisanen<sup>16</sup>, Aron Vrtala<sup>7</sup>, Paul E. Wagner<sup>7</sup>, Hansueli Walther<sup>9</sup>, Ernest Weingartner<sup>9</sup>, Heike Wex<sup>10</sup>, Paul M. Winkler<sup>7</sup>, Kenneth S. Carslaw<sup>4</sup>, Douglas R. Worsnop<sup>5,17</sup>, Urs Baltensperger<sup>9</sup> & Markku Kulmala<sup>5</sup>

#### CLOUD institutes:

<b>Austria:</b>	University of Innsbruck University of Vienna
<b>Finland:</b>	Finnish Meteorological Institute Helsinki Institute of Physics University of Eastern Finland University of Helsinki
<b>Germany:</b>	Johann Wolfgang Goethe University Frankfurt Karlsruhe Institute of Technology Leibniz Institute for Tropospheric Research
<b>Portugal:</b>	University of Beira Interior University of Lisbon
<b>Russia:</b>	Lebedev Physical Institute
<b>Switzerland:</b>	CERN Paul Scherrer Institut
<b>United Kingdom:</b>	University of Manchester University of Leeds
<b>United States of America:</b>	California Institute of Technology

#### CLOUD now “in production”. Examples of the produced results:

- J. Almeida et al., *Molecular understanding of amine-sulphuric acid particle nucleation in the atmosphere*, Nature, 2013
- H. Keskinen et al., *Evolution of particle composition in CLOUD nucleation experiments*, Atmospheric Chemistry and Physics, 2013
- S. Schobesberger et al., *Molecular understanding of atmospheric particle formation from sulfuric acid and large oxidized organic molecules*, PNAS, 2013
- F. Riccobono et al., *Oxidation Products of Biogenic Emissions Contribute to Nucleation of Atmospheric Particles*, Science, 2014
- F. Bianchi et al., *Insight into acid-base nucleation experiments by comparison of the chemical composition of positive, negative and neutral clusters*, PNAS, 2014
- J. Kirkby et al., *Ion-induced nucleation of pure biogenic particles*, Nature, 2016
- J. Tröstl et al., *The role of low-volatility organic compounds in initial particle growth in the atmosphere*, Nature, 2016
- E. Dunne et al., *Global particle formation from CERN CLOUD measurements*, Science, 2016

Further information on the CLOUD experiment:  
<https://home.cern/about/experiments/cloud>



Thank you for your attention!



**EXTRA SLIDES:**

# Example of on-going CLOUD measurements:

Recreating of boreal forest conditions, to understand the observed aerosol particle nucleation and growth.

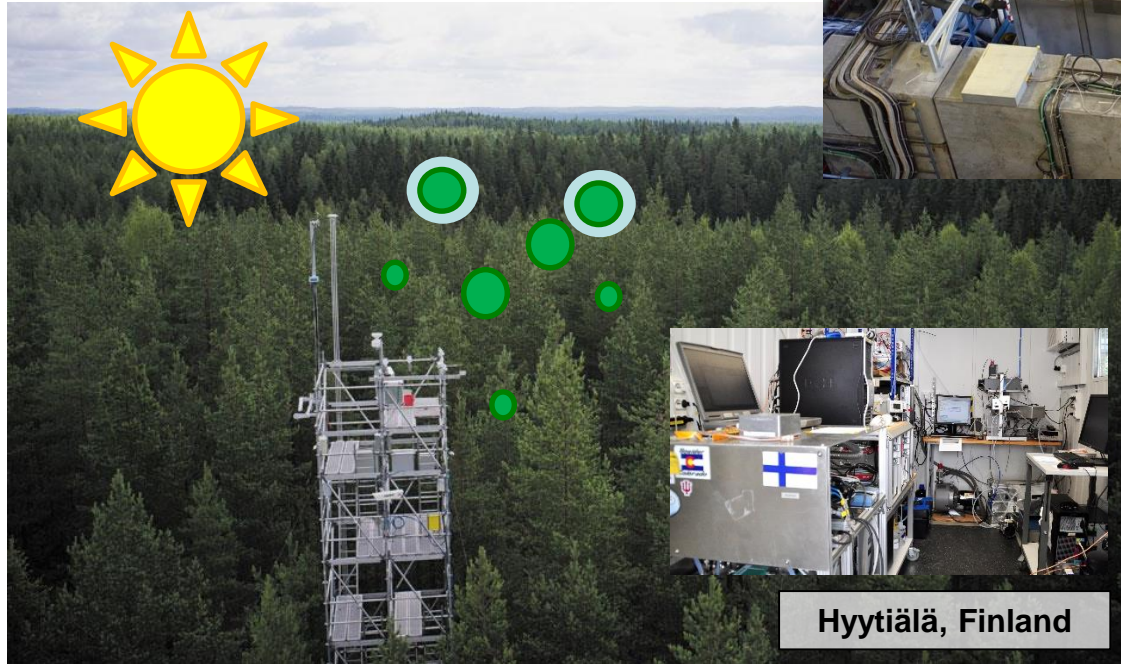
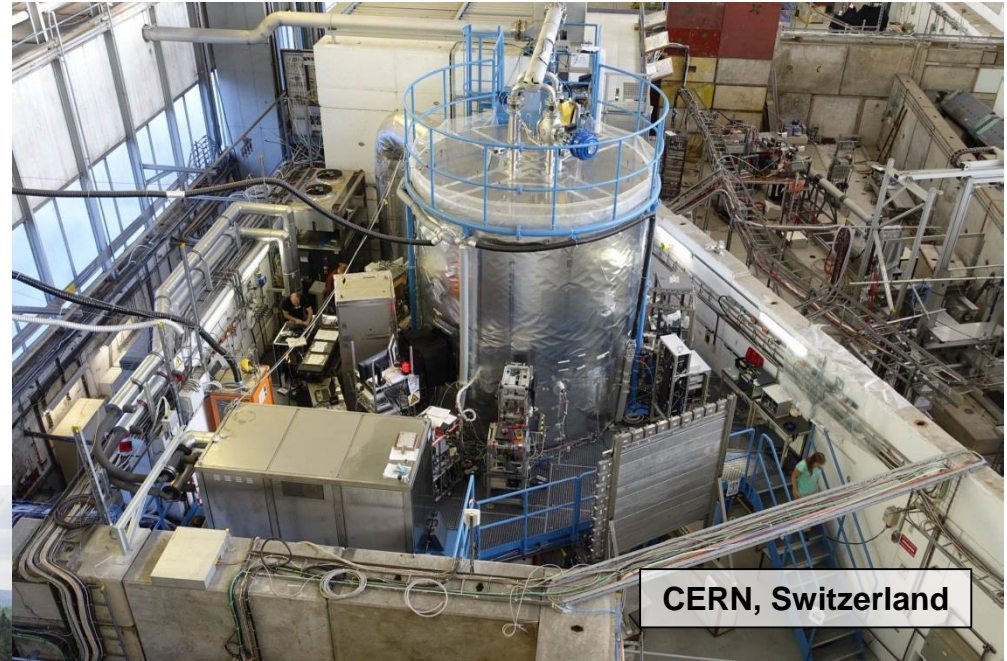

***Similar instrument set-up used in field as well (direct atmospheric measurements)!!***

[https://www.youtube.com/watch?v=En  
eDwu0HrVg](https://www.youtube.com/watch?v=En<br/>eDwu0HrVg)

**See youtube:  
“NO PARTICLES NO FOG”**



What's Up with Clouds - Today I Found Out. We look at them every day, but few of us realize what they are made of.

[www.todayifoundout.com/index.php/.../whats-up-with-clouds/](http://www.todayifoundout.com/index.php/.../whats-up-with-clouds/)

# HOW WOULD YOU MAKE A BIG CLOUD UP IN THE AIR?



# Researcher's work day at CLOUD

## campaign on a morning shift at 07:00-15:00:

- 06:00 Wake-up and morning coffee
- 07:00 To CLOUD: updates from last shift and checking the instruments
- 07:00-14:00 Starting new run: operators present and others monitoring remotely their instruments or fixing their instrument if needed
- 12:00-13:00 Lunch break
- 12:00-15:00 Analysis and plotting of the experimental data
- 15:00-17:30 Daily meeting: quick-look to the data and planning next runs
- 18:00-22:00 Instrument calibrations and preparation/modifications for nights and next day's experimental runs

During the CLOUD campaign we work in 3 shifts (07:00-15:00, 15:00-23:00, 23:00-07:00). Two operator present all times.



# Air pollution control and decreasing new particle formation may lead to strong climate warming

30 OCTOBER 2009 VOL 326 **SCIENCE** [www.sciencemag.org](http://www.sciencemag.org)

*Published by AAAS*

## PERSPECTIVES

ATMOSPHERIC SCIENCE

# Clean the Air, Heat the Planet?

Almut Arneth,<sup>1,2\*</sup> Nadine Unger,<sup>3</sup> Markku Kulmala,<sup>2</sup> Meinrat O. Andreae<sup>4</sup>

Measures to control emissions of air pollutants may have unintended climatic consequences.



# Aerosol particles have a net cooling effect on the global climate (IPCC, 2013):

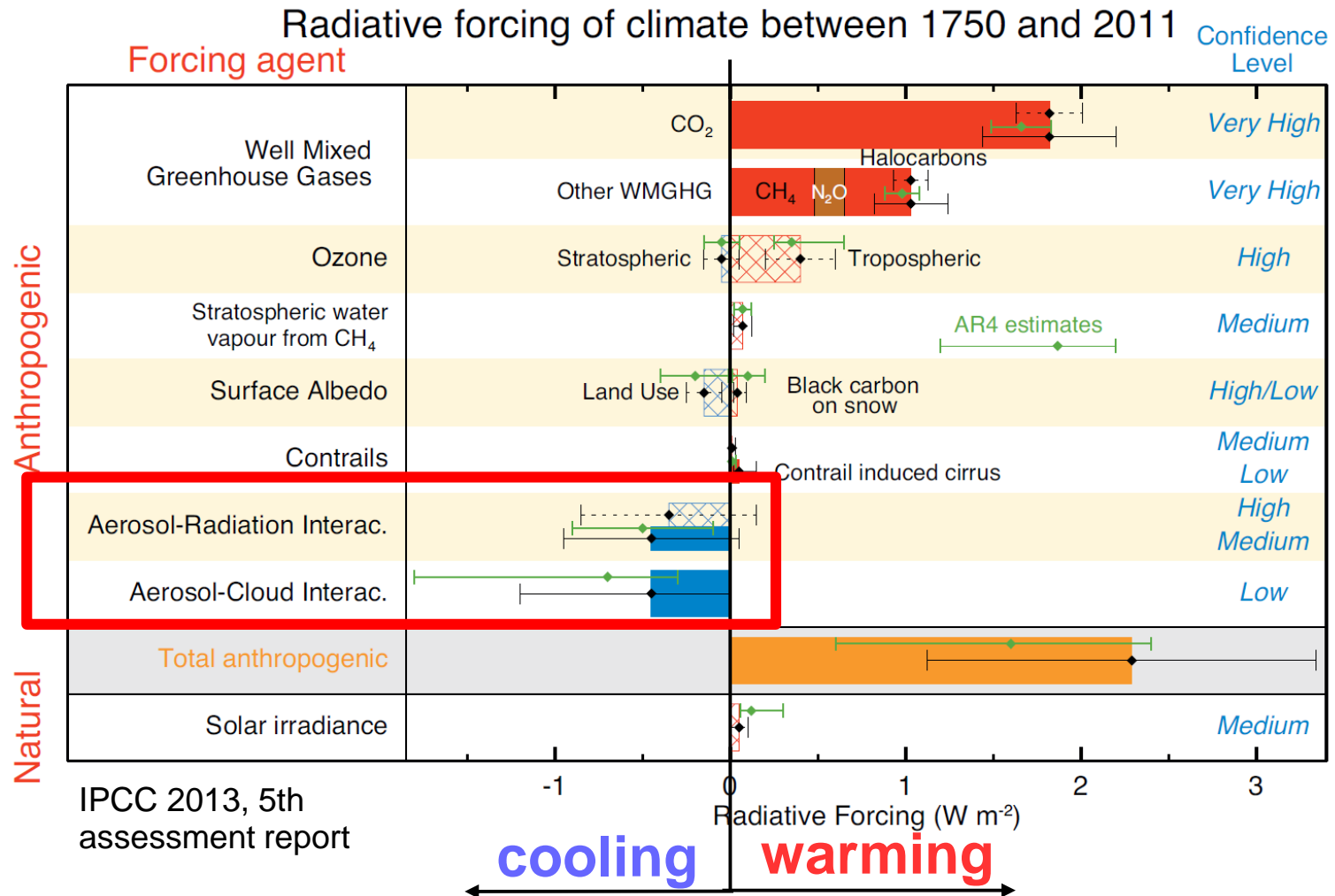

# Warming-induced increase in aerosol number concentration likely to moderate climate change

**Feedback** on increasing air temperature relation to aerosol-cloud interactions:  
Relationship between air temperature and the number concentration and burden of CCN-sized aerosol particles

Paasonen et al., *Nature Geo.Sci.* 2013

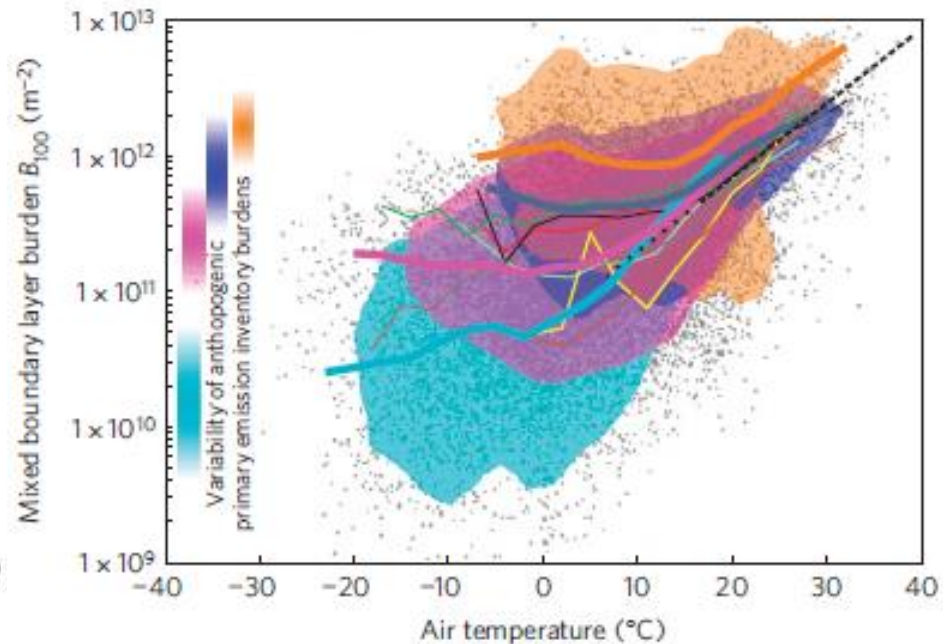
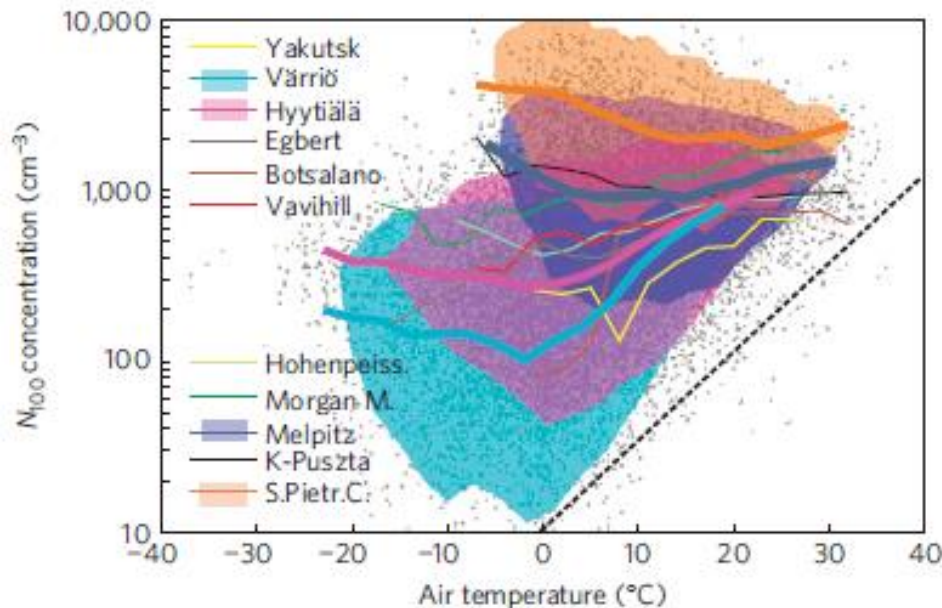

# Atmospheric aerosol particles: why so diverse and complex?

- Aerosol is a mixture of gas, and solid or liquid particles floating in the gas
- Diameters  $\sim 10^{-9} - 10^{-4}$  m
- Concentrations  $\sim 10^0 - 10^5$   $\text{cm}^{-3}$  ( $10^{-1} - 10^2$   $\mu\text{g m}^{-3}$ )
- Sources and sinks of aerosols: particles constantly interact physically, chemically and dynamically with gases and each other



# Key steps of clustering process occur in the sub-2 nanometer (nm) size range via neutral pathways

- Direct size-segregated observations have not been possible until very recently

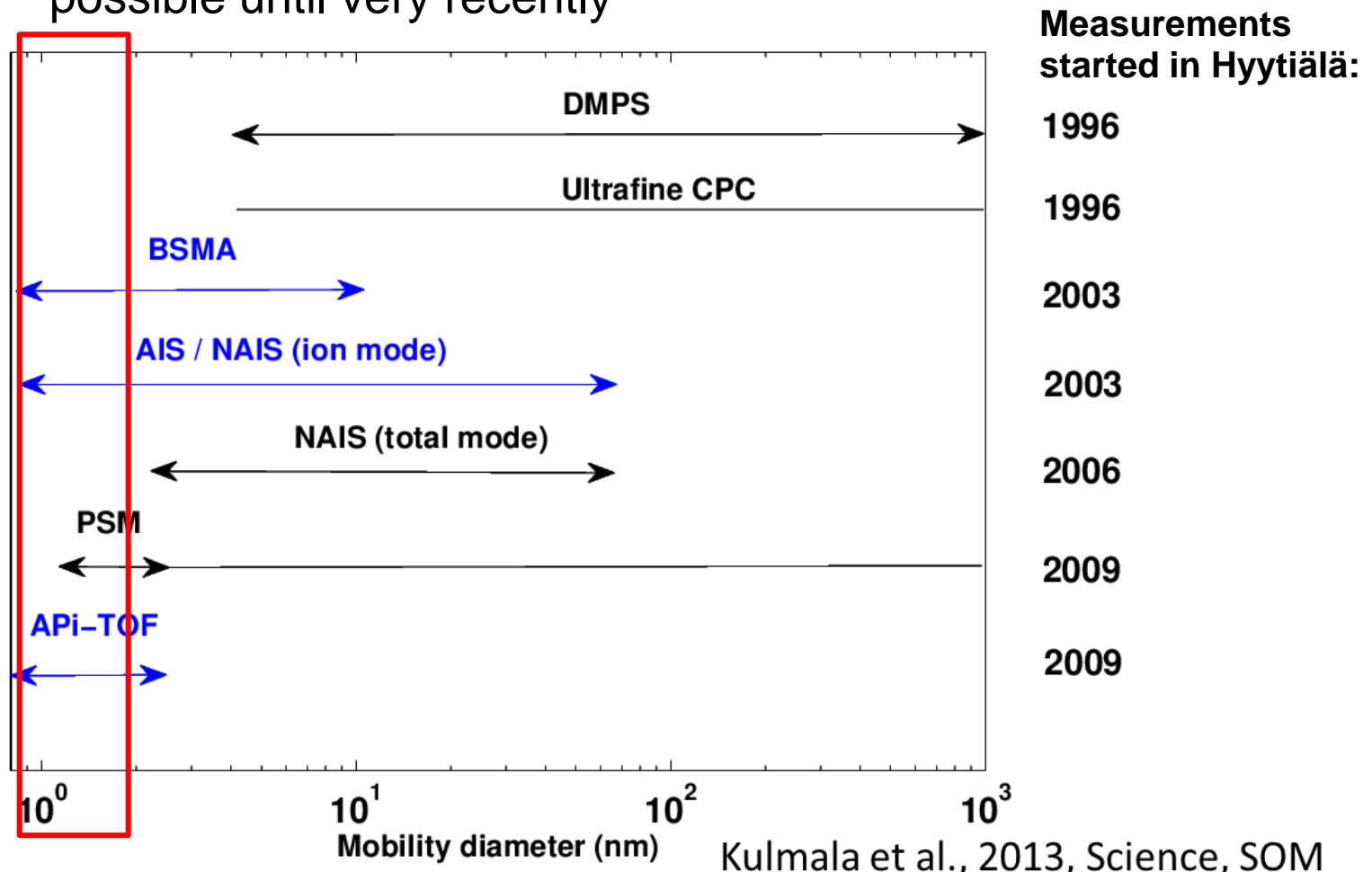

# Direct observations on atmospheric “cluster by cluster” growth rates with novel instrumentation

- Detection of sub-3 nm atmospheric clusters and particles with newly developed novel instrumentation

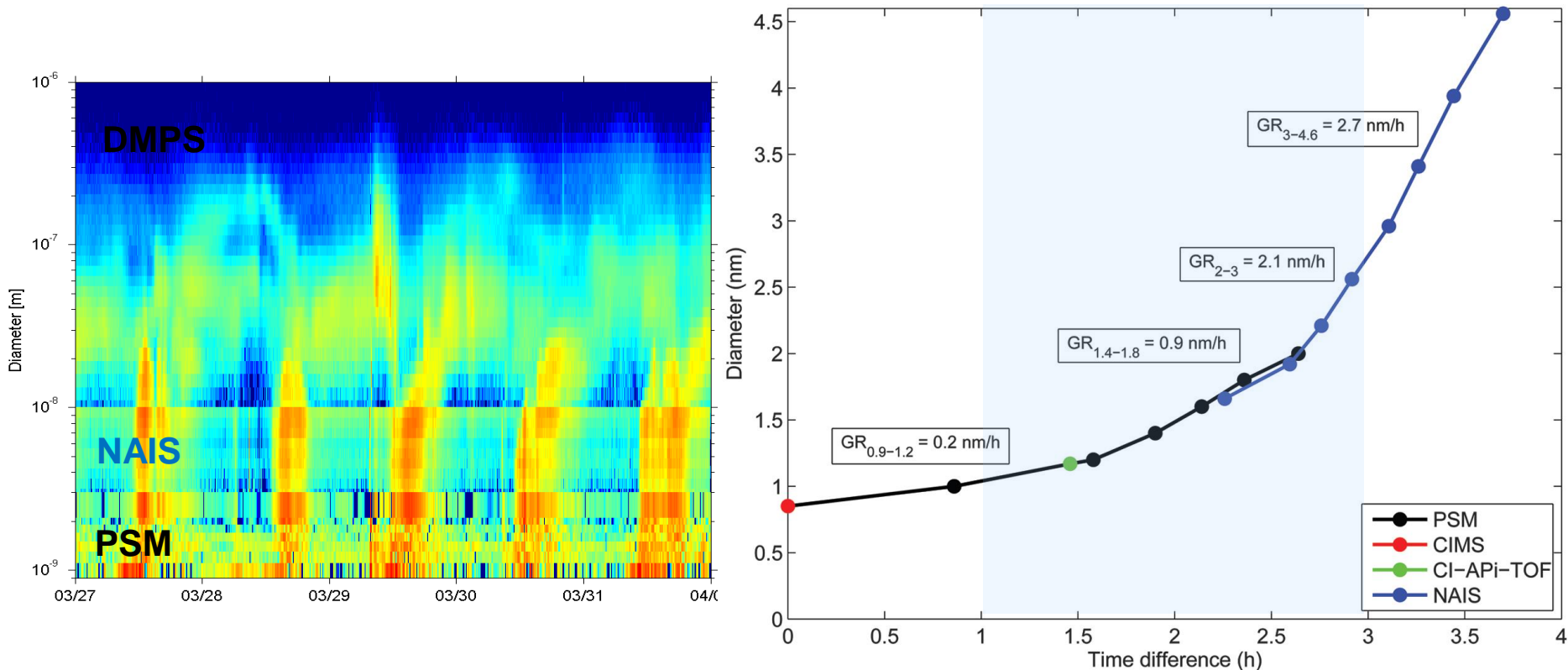

# Feedback loops on biosphere-atmosphere interaction with increasing CO<sub>2</sub>:

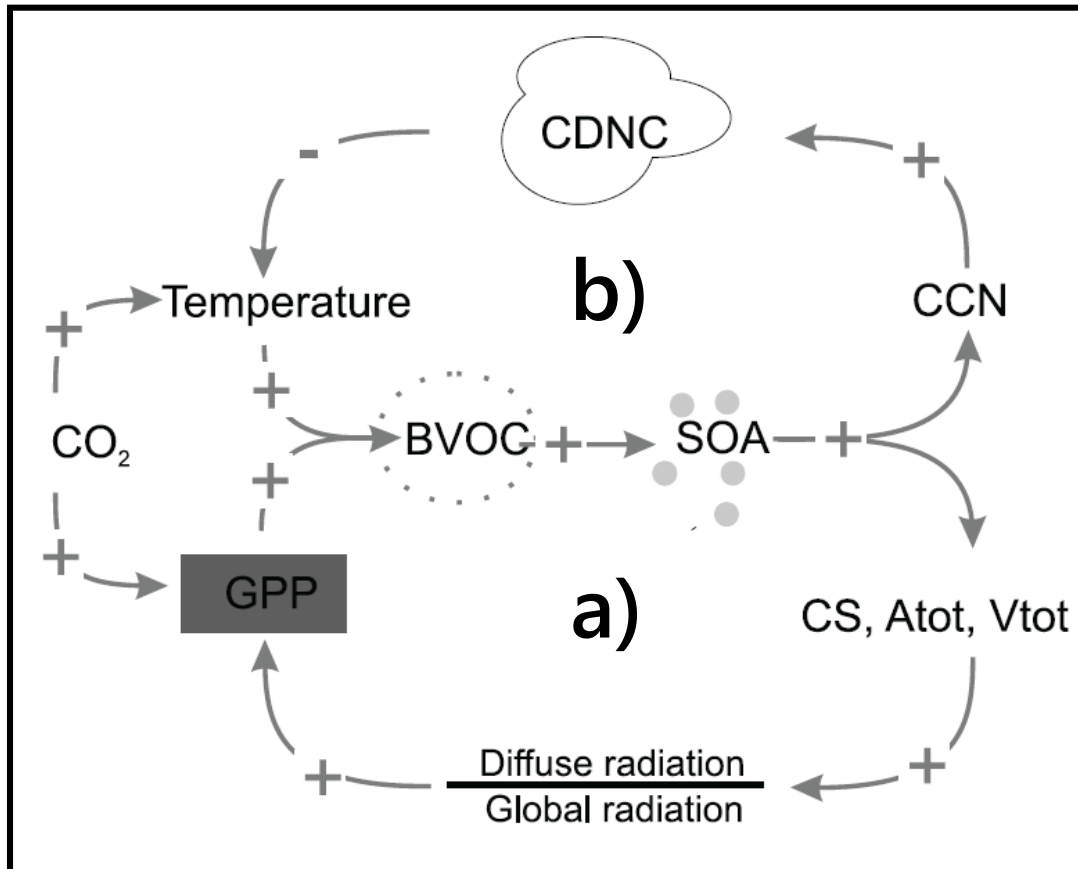

- Increasing atmospheric CO<sub>2</sub> concentration, changes GPP associated with carbon uptake, SOA formation in the atmosphere, and transfer of a) both diffuse and global radiation in cloud-free air, b) cloud cover.

# Why to study changes in Earth's climate?

## Past vs. future climate

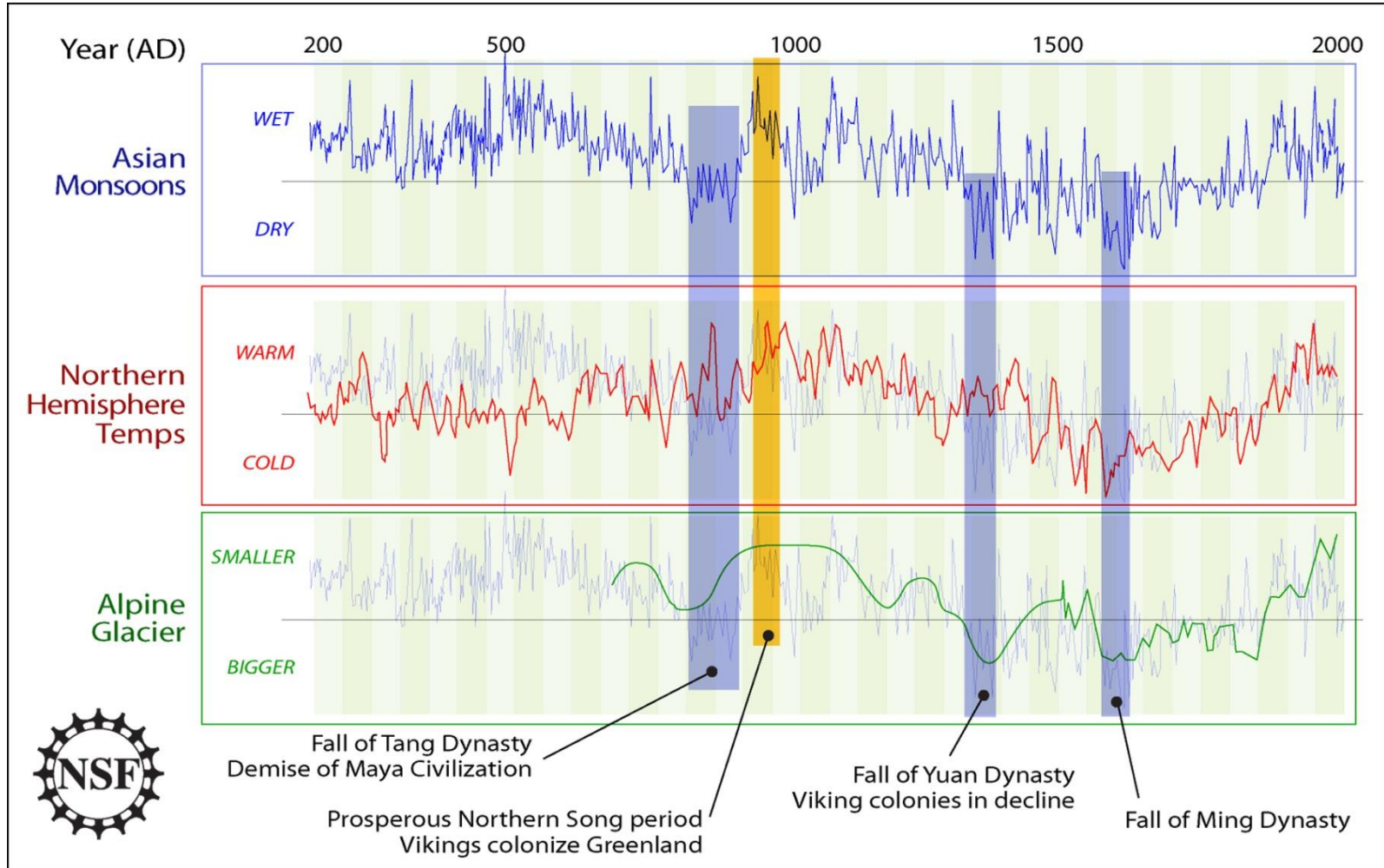

Source: U.S. National Science Foundation, 2008



# Suggested Solar → Cosmic ray → Climate mechanism??

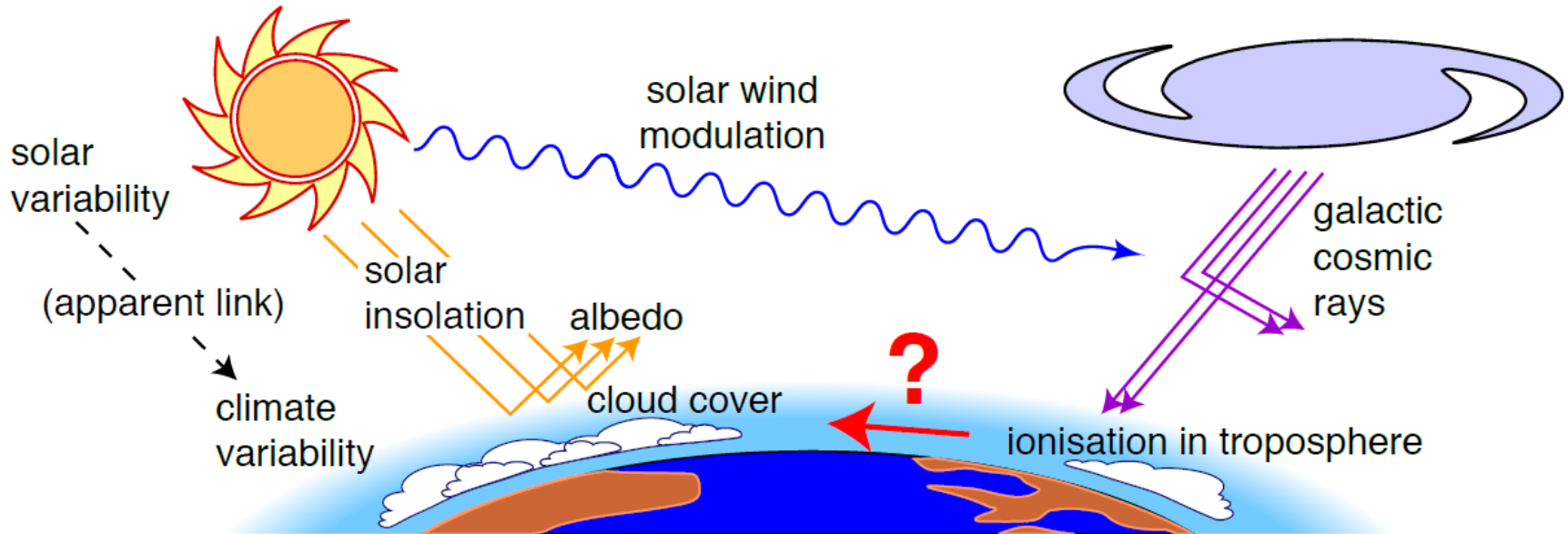

- **Higher solar activity** → **reduced GCRs** <sup>?</sup> → **reduced cloud cover** → **warmer climate**
- Satellite observations not yet settled:  
Significant GCR-cloud correlations reported by some (Svensmark, Laken...) and weak or excluded by others (Kristjansson, Wolfendale...)



Aerosol particles have an effect on human health  
**REGIONAL, GLOBAL**



# Aerosol particles have a regional effect on air quality and visibility

## **REGIONAL**

Helsinki August 2006,  
Piia Anttila FMI



# Run list at CLOUD11 campaign: nucleation with pure organics

1				
2	Start time	Run	Type	Run description
3	dd.mm.yyyy HH:MM:SS			<b>Ammonia makes the party :)</b>
111	11.10.2016 23:33:30	1,811.10	CLEAN	Beam on, UVX 0%, UVH 0%
112	12.10.2016 01:51:25	1,812.01	N	Soup with NOx, UVS30%; AP 9/225/2.7, BCY 1/1000, IP 5/10.5/2.5
113	12.10.2016 03:54:30	1,812.02	N	Soup with NOx, UVS30%; AP 9/225/5.4, BCY 2/1000, IP 5/10.5/5
114	12.10.2016 06:16:30	1,812.03	N	Soup with NO UVS30%; AP 9/225/10 (1200ppt), BCY 400/1000 (400ppt), IP 5/10.5/10 (10ppb)
115	12.10.2016 08:55:30	1,812.04	N	Soup with NOx, UVS80%; AP 9/225/10 (1200ppt), BCY 400/1000 (400ppt), IP 5/10.5/10 (10ppb)
116	12.10.2016 10:49:30	1812.05	CLEAN	Cleaning
117	12.10.2016 13:28:30	1,812.06	GCR	Soup with NOx, AP 300ppt, BCY 100ppt, IP 2.5ppb
118	12.10.2016 16:22:00	1,812.07	GCR	Reduce NOx flow to get 300ppt instead of 1ppb, rest constant
119	12.10.2016 18:30:00	1,812.08	GCR	Soup with NOx, AP 600ppt, BCY 200ppt, IP 5ppb
120	12.10.2016 21:42:00	1,812.09	GCR	Soup with NOx, AP 1200ppt, BCY 400ppt, IP 10ppb
121	13.10.2016 00:01:00	1,812.10	GCR	High conc Soup with UVX 400x5
122	13.10.2016 01:03:00	1,812.11	N	High conc Soup with UVX 400x5
123	13.10.2016 01:35:00	1,812.12	CLEAN	Cleaning
124	13.10			
125	13.10			
126	13.10			
127	13.10			
128	13.10.2016 12:37:00	1,813.05	BEAM	Soup AP 600ppt, BCY 200ppt, IP 5ppb, Beam 14mm
129	13.10.2016 15:13:00	1,813.06	BEAM	Soup AP 600ppt, BCY 200ppt, IP 5ppb, Beam 25mm
130	13.10.2016 17:10:00	1,813.07	BEAM	Soup AP 600ppt, BCY 200ppt, IP 5ppb, Beam 50mm
151	15.10.2016 19:39:00	1,816.06	GCR	J+25C with NO2, organic soup 600/200/5
152	16.10.2016 00:49:00	1,816.07	GCR	J+25C with NO2, organic soup 1200/400/10
153	16.10.2016 03:52:26	1,816.08	GCR	J+25C with NO2, organic soup 1200/400/10 + UVX 400x5
154	16.10.2016 05:32:32	1,816.09	N	CS step
155	16.10.2016 05:57:15	1,816.10	BEAM	beam cleaning
156	16.10.2016 07:56:22	1,817.01	N	Pure biogenic soup at 25C Daytime

**Soup = mixture of organic gases; AP= alphapinene; BCY = betacaryophyllene; IP = isoprene; CS = condensation sink; J = particle formation rate**

# Primary Aerosol Sources: natural vs human-made

## Natural sources:



Sea spray



Mineral dust



Volcano ▶ Sulfates,  
dust



Biomass burning  
▶ Organics

## Human-made sources:



Traffic emissions ▶ Soot



Industrial Emissions

# CLOUD line beam area just before the CLOUD11 runs at September 2016:

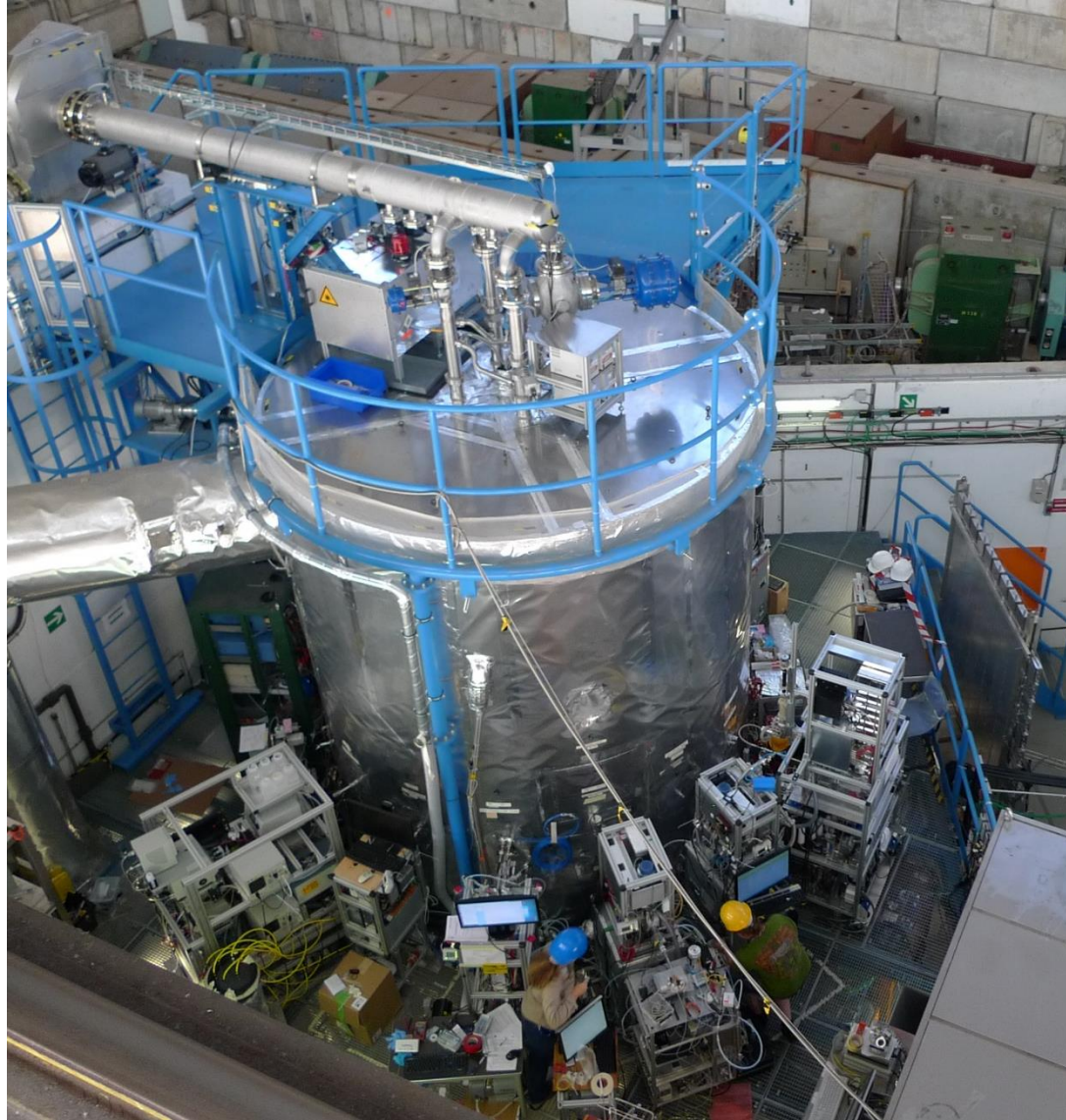

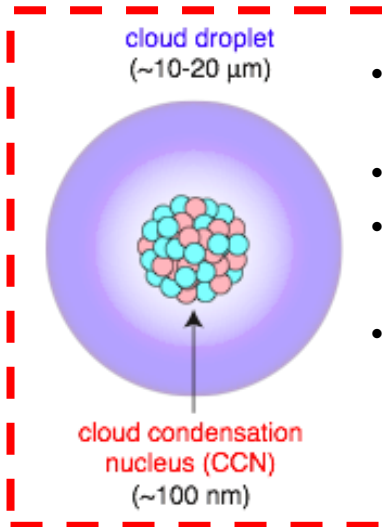
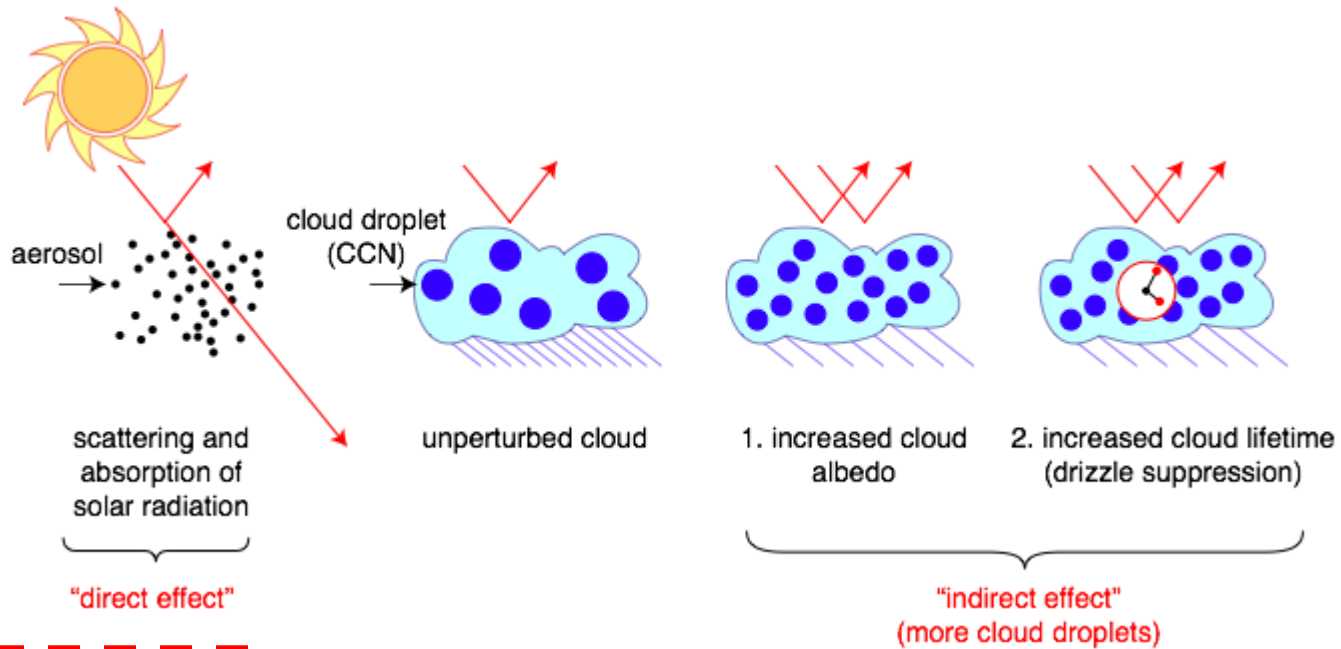

- **All cloud droplets form on aerosol “seeds” known as cloud condensation nuclei - CCN**
- Cloud properties are sensitive to number of droplets
- More aerosols/CCN:
  - Brighter clouds, with longer lifetimes
- **Sources of atmospheric aerosols:**
  - Primary (dust, sea salt, fires)
  - Secondary (gas-to-particle conversion)

See youtube: “No particles no fog” <https://www.youtube.com/watch?v=EneDwu0HrVg>

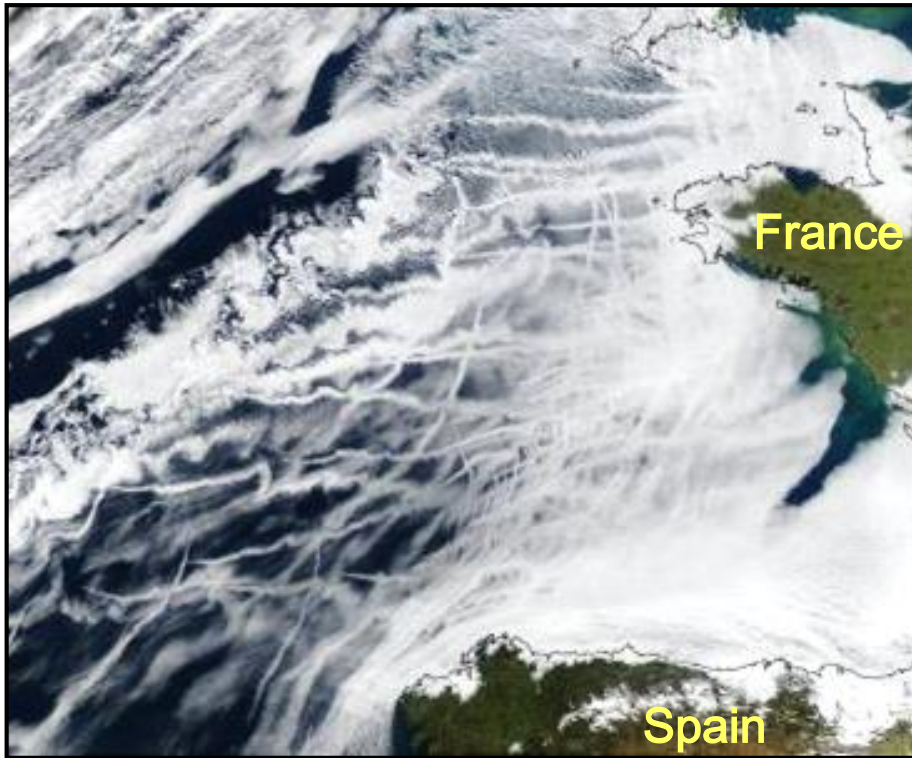



# *Indirect effect of carbonaceous particles: Ship tracks*

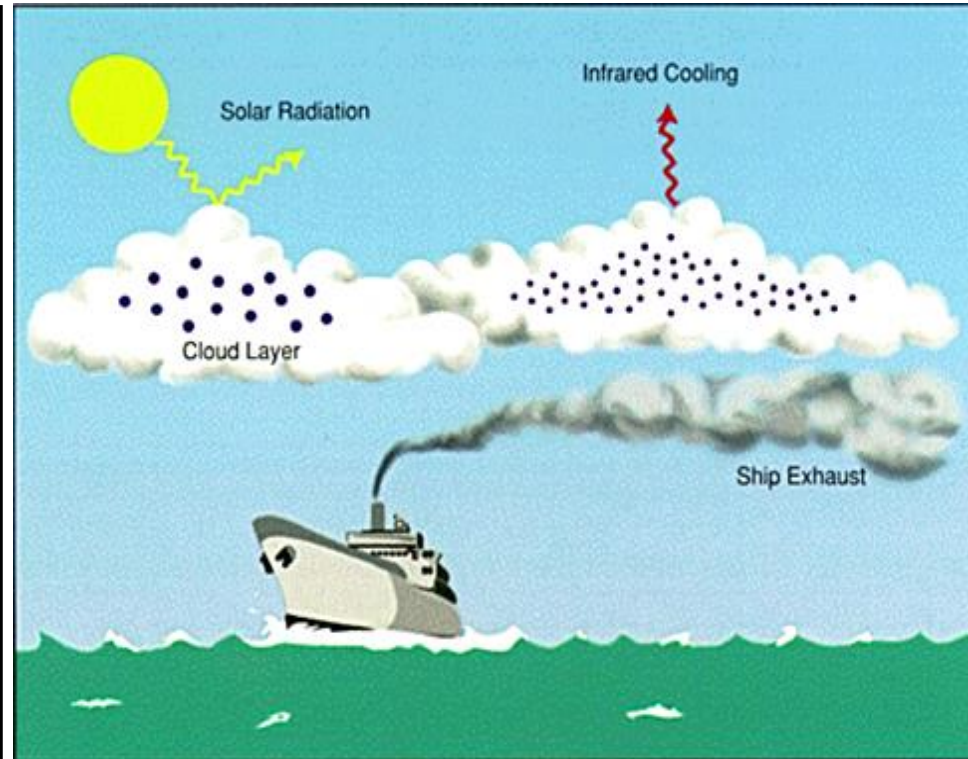
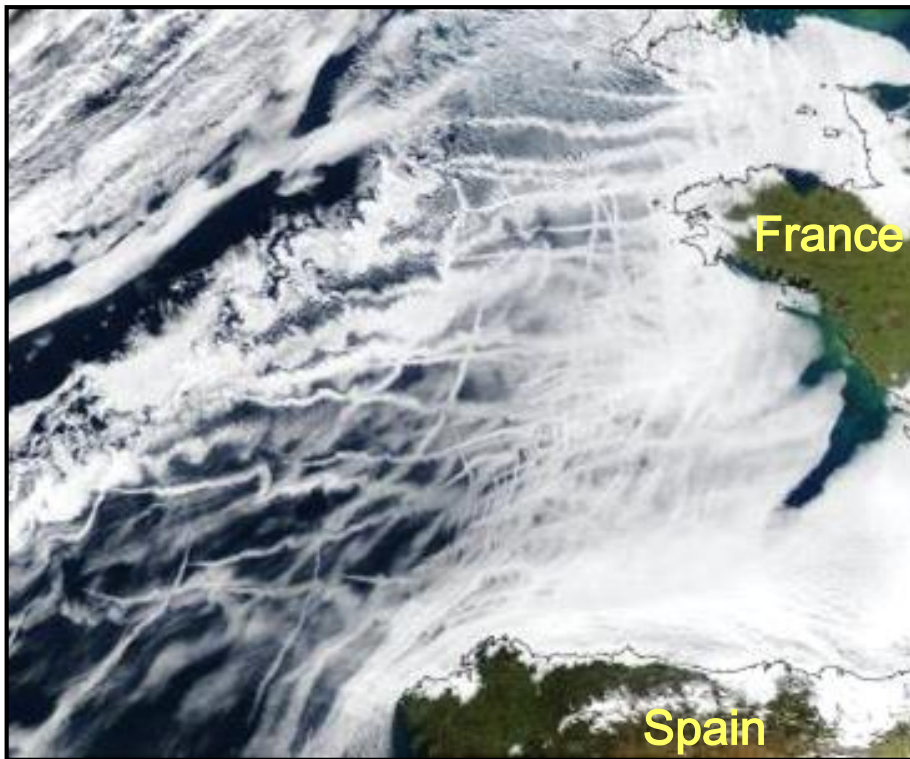

Ship tracks on the East Atlantic

Aerosol particles emitted by ships (soot particles with a high sulfur content) act as CCN and form clouds and enhance cloud reflectivity

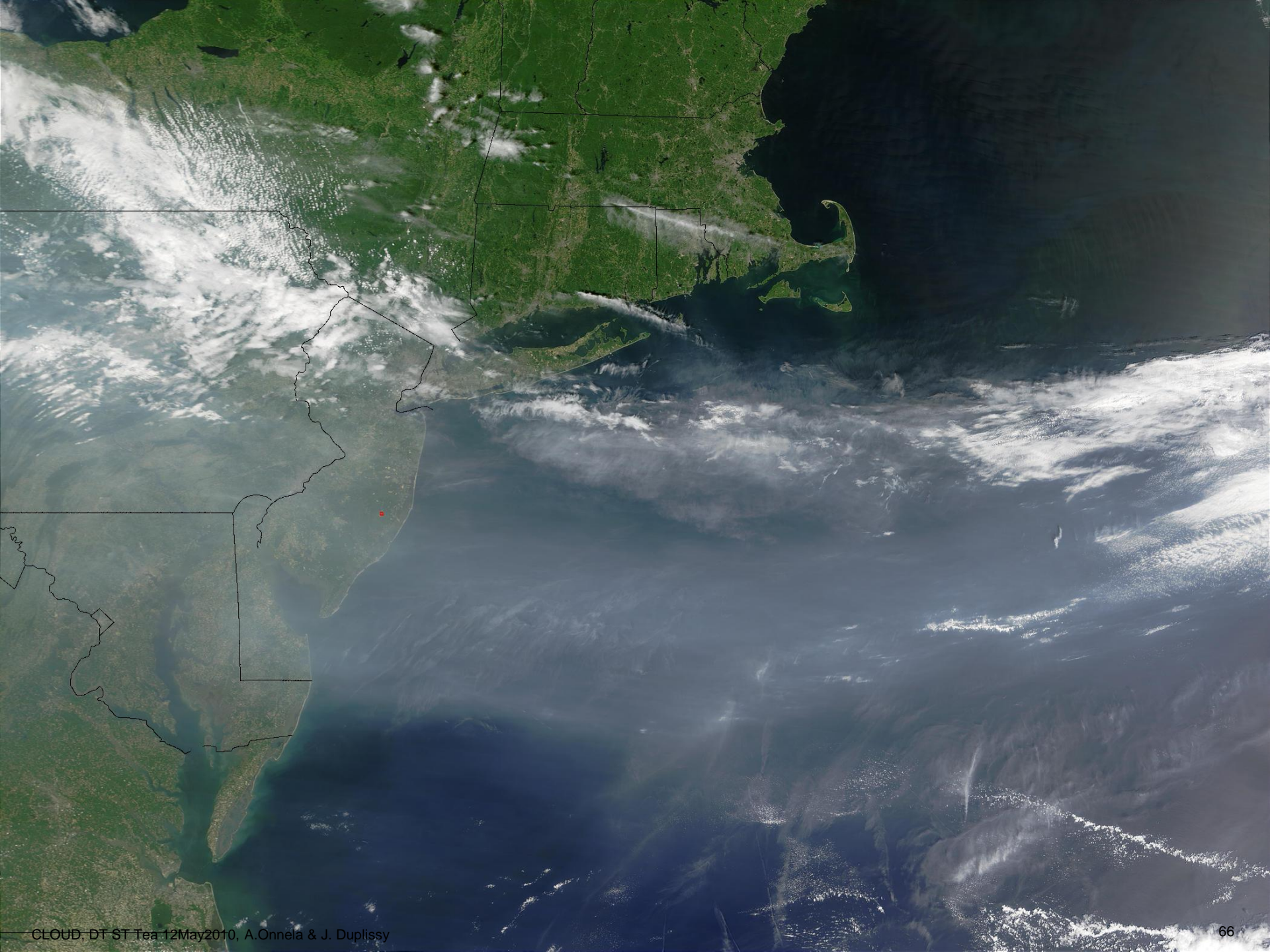

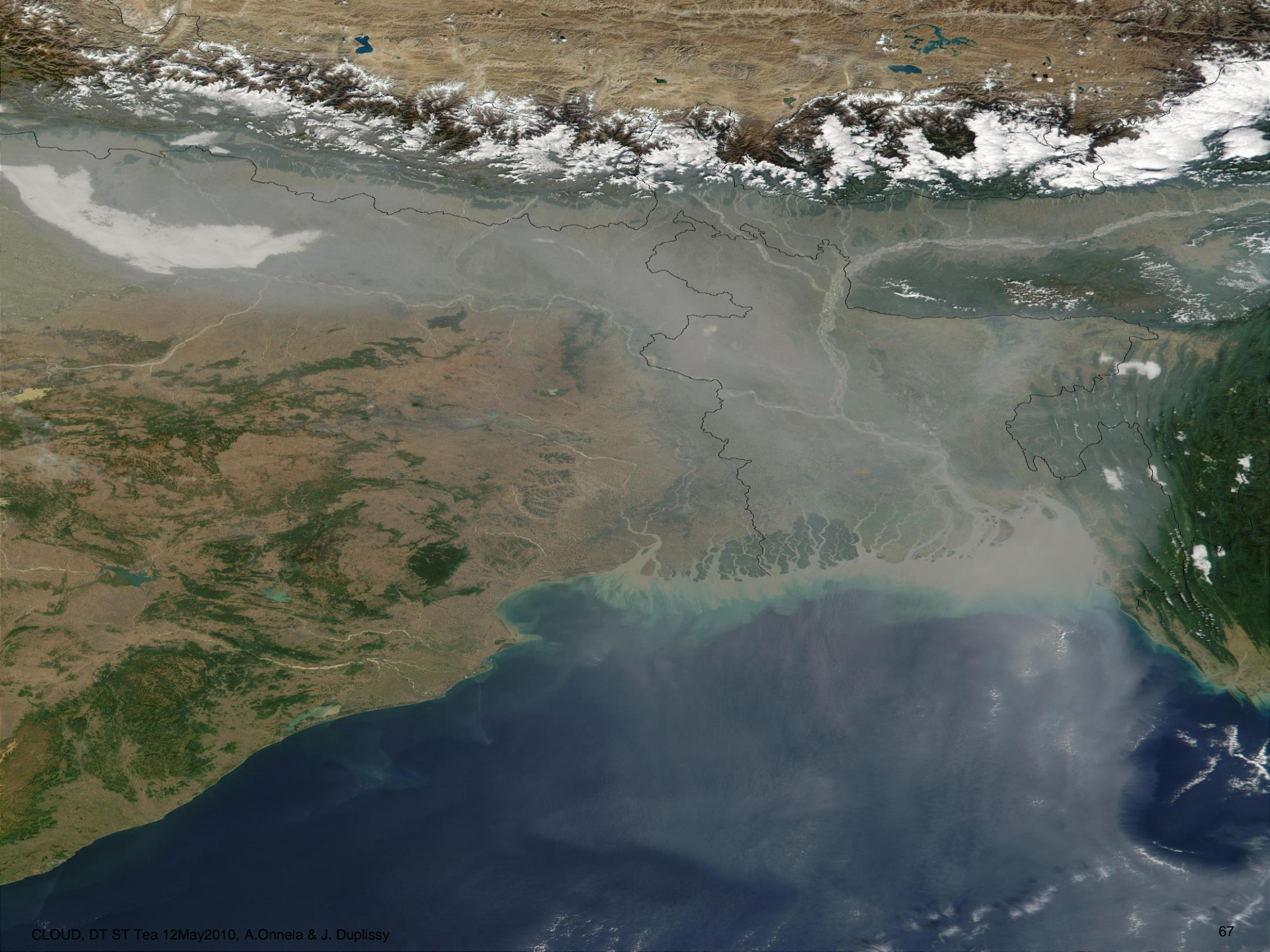





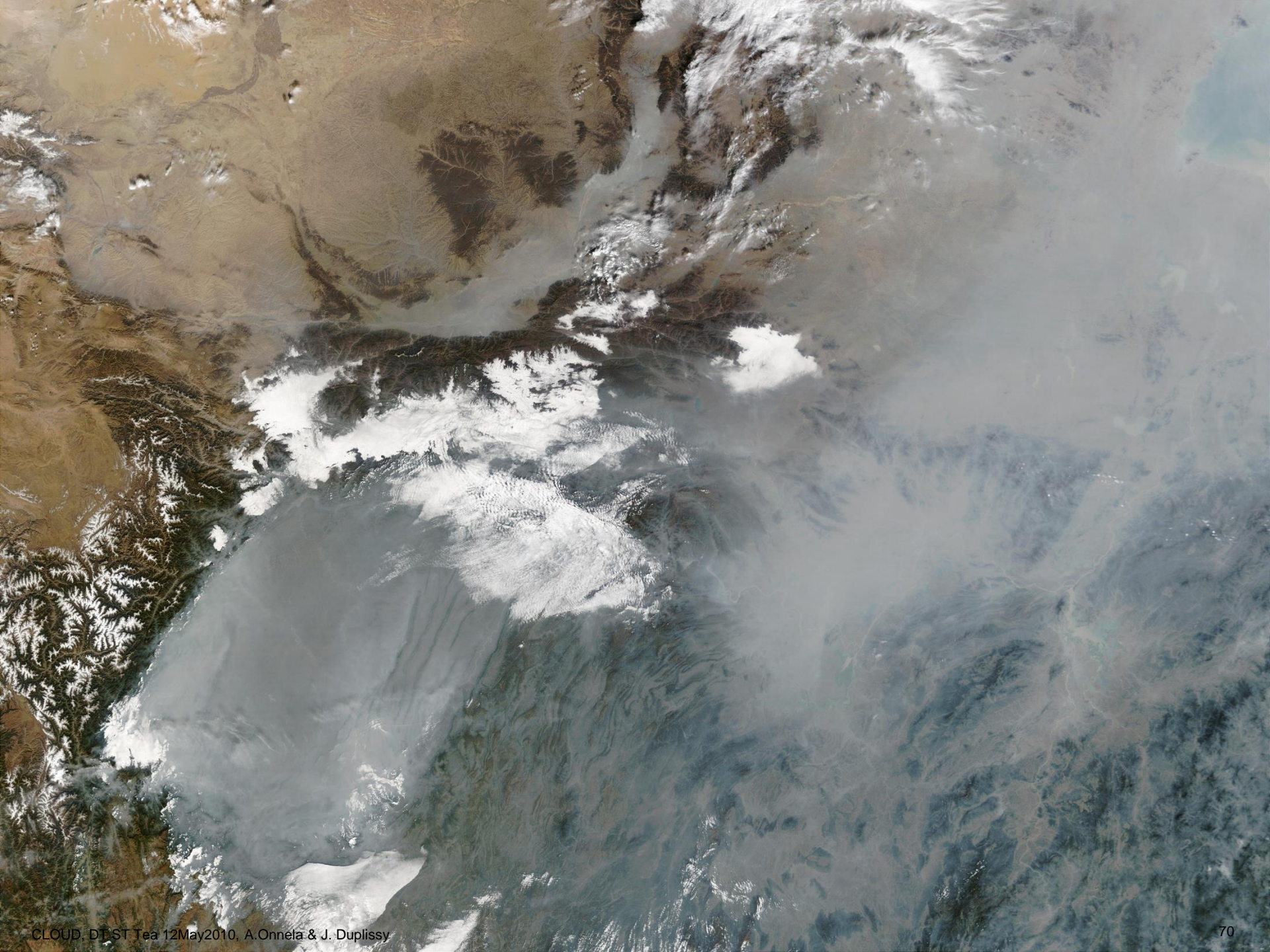



**What is in common with the cloud chamber tracks and the air plane contrails?**