

# HOW TO WRITE A GOOD PAPER (and thesis)

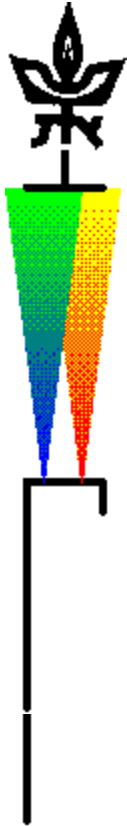

R.L. Boxman

Tel Aviv University

©2017, R.L. Boxman

# The Problem:

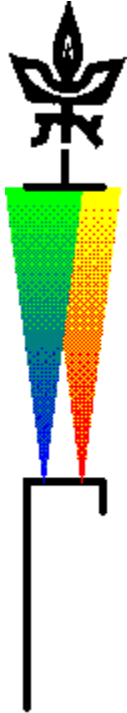

- We spend ~20% of our time preparing “research reports” -- without training
- In contrast, we are trained to program computers, use oscilloscopes, SEM’s etc.

# Lecture Objective

- Give participants “recipe” for preparing good research papers:
  - in terms of style and organization (content is up to you!)
  - acceptable to IEEE transactions, AIP and IOP journals, etc.
  - easy to read
- **Not a substitute for full semester writing course**

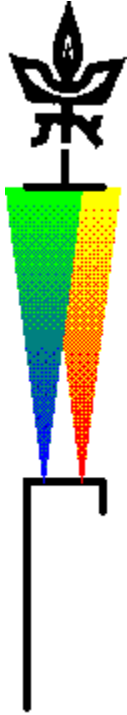

# Lesson Plan

- Introduction: communications channel
- Before Writing
- English Composition Tips
- Organization of the Research Paper
  - Introduction
  - Method
  - Results
  - Discussion
  - Conclusions
  - (Abstract, Title)
- Summary and Conclusions

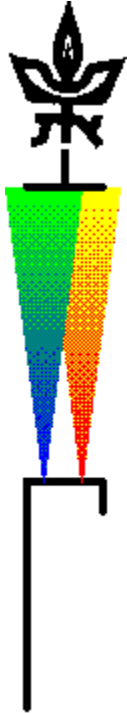

# Journal Paper -- a communications channel

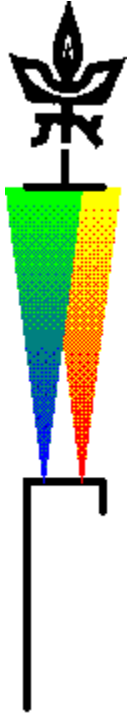

- Objective of scientific paper - convey information, as efficiently as possible.
- One writer - many readers -- burden on writer to communicate efficiently.
- Analog to broadcast channel -- Tx and Rx must be on same wavelength, use same protocol, expensive Tx, cheap Rx.
- Protocol for paper fixed by convention

# Not a Murder Mystery!

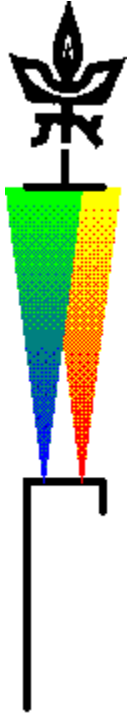

- No virtue in keeping reader in suspense
- Reader wants info., not your personal history in arriving at results
  - Time sequence relevant, only to the extent that it affects result
- Organization, sequence of presentation optimized to convey information (not to make a good story!)

# Before you begin to write – Define the “Research Question”

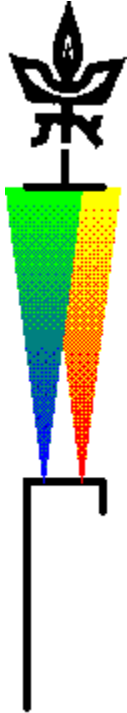

- Good research papers revolve around a “research question”
  - Example: “How does bias voltage affect the adhesion and interface structure of Ti-Al-N coatings applied to stainless steel substrates?”
- In other fields (biology, medicine), the research question is stated formally.
- In our field, the Research Question should be:
  - Implicit in Phase 4 of Introduction (to be described)
  - Answered in the Conclusions

# Ethical Issues

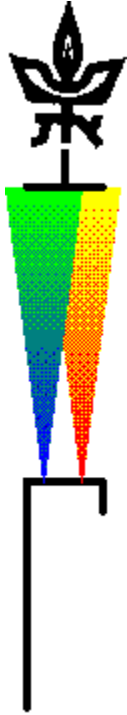

- Scientific Integrity
- Plagiarism – passing off someone else’s work as your own
  - Everything (ideas, data, pictures, etc.) in report must be yours, unless a reference is cited
- No “double publication”



# English Composition Suggestions

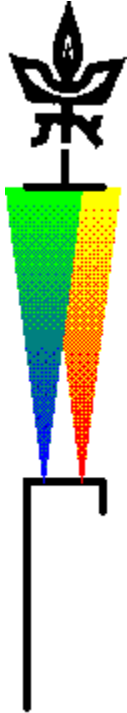

- Hierarchal Structure (“top-down organization”):
  - Chapter, Section
    - Sub-section, etc.
      - Paragraph
        - » Sentence
- Before writing text, write a detailed outline – down to the level of defining the topic of each paragraph
  - Major problem – misplaced statements (method in results, results in discussion, etc.)

# English Composition, cont'd

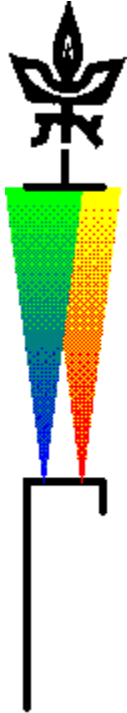

- “Bottom-up” organization:
  - The sentence:
    - Expresses a complete thought
    - Most sentences should use the ‘natural’ English word order: subject, verb, predicate
- “This relation is valid when  $x > r$ ”
- “The chamber was evacuated with a diffusion pump”

# English Composition – The sentence, cont'd

- Simplify sentences by using strong natural verbs, rather than derived noun plus weak generalized verb:

**Not:** *Measurements were made of the coating hardness using a nano-indenter.*

**Instead write:** **The coating hardness was measured using a nano-indenter.**

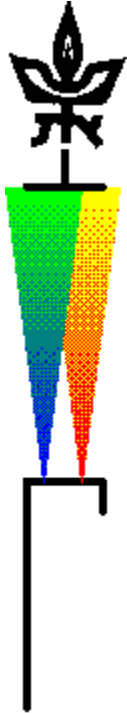

# English Composition – The sentence, cont'd

- Avoid beginning the sentence with long prepositional phrases

*Using a CSEM model 3400 nano-indenter equipped with a flashlight and a microcomputer, the hardness of the coating was measured.*

Instead:

*The hardness of the coating was measured using a CSEM model 3400 nano-indenter equipped with a flashlight and a microcomputer*

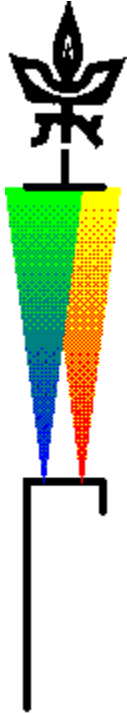

# English Composition, cont'd

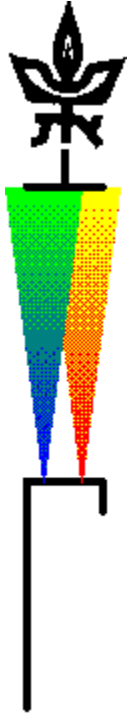

- The Paragraph
  - Develops a topic
  - At least 2 sentences, more preferred
  - 1st sentence defines the topic of the paragraph
  - Subsequent sentences develop idea in logical order
  - Final sentence presents conclusion, or main point

# English Composition- The Paragraph, cont'd

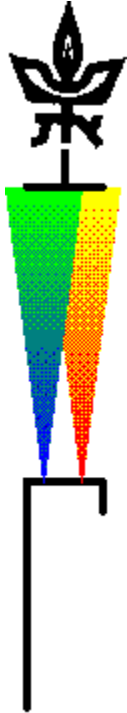

- In the final stage, the net deposition rate on the anode is zero. Cathodic material is either deflected by the high pressure A-plasma before it reaches the anode, or is re-evaporated after a very short dwell time. MP's reaching the anode will likewise be evaporated. A given location on the substrate may be exposed primarily to C-plasma or A-plasma, according to the geometry of the electrodes and shields and the plasma flow dynamics, as illustrated schematically in Fig. 3
  - Par. Subject
  - Development of subject
  - Final Sent. – Main point

# Word Processor Instructions

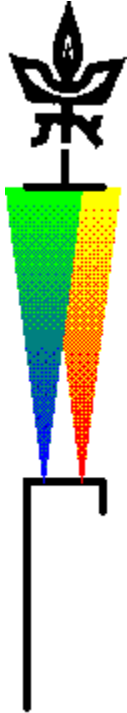

- Frequent back-ups
- Use defined “styles” for headings, etc.
- Indent, extra space before new paragraph
  - Build into style
- Use automatic endnote numbering
- Do NOT insert extra blank spaces or blank lines
  - It defeats automatic features of word processors
  - Use TAB to control horizontal spacing
  - Use “insert line” and “page break” if needed

# Organization of the Paper

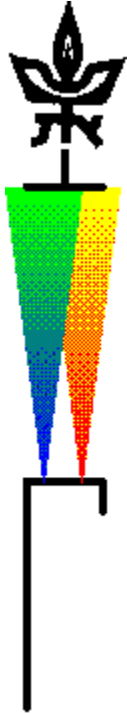

Abstract	Summarizes work
Introduction	What are we talking about?
Experimental Details	What did we do?
Results	What did we get?
Discussion	So What?
Conclusions	~3 key points you want reader to remember



# Trapezoidal Organization

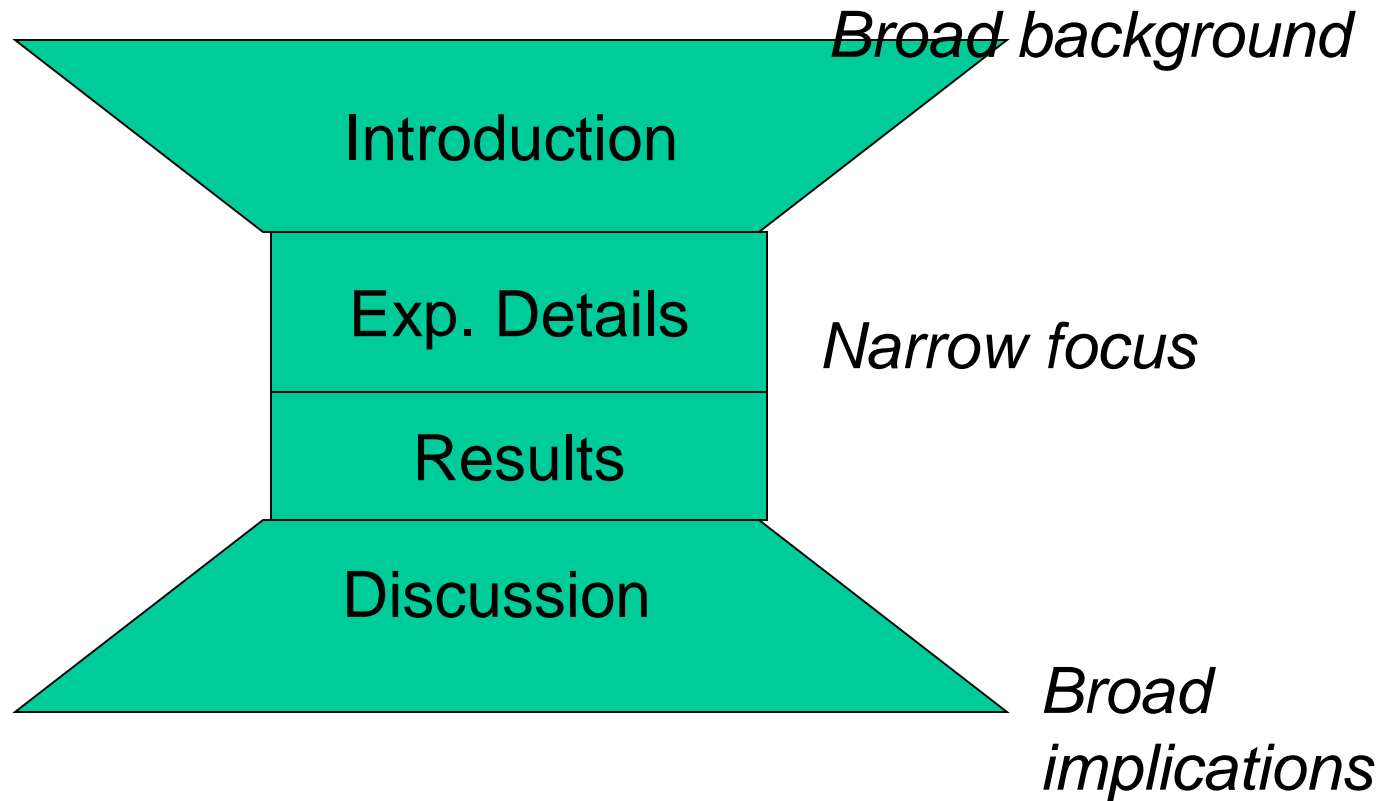
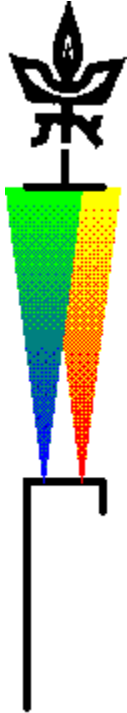

# Introduction

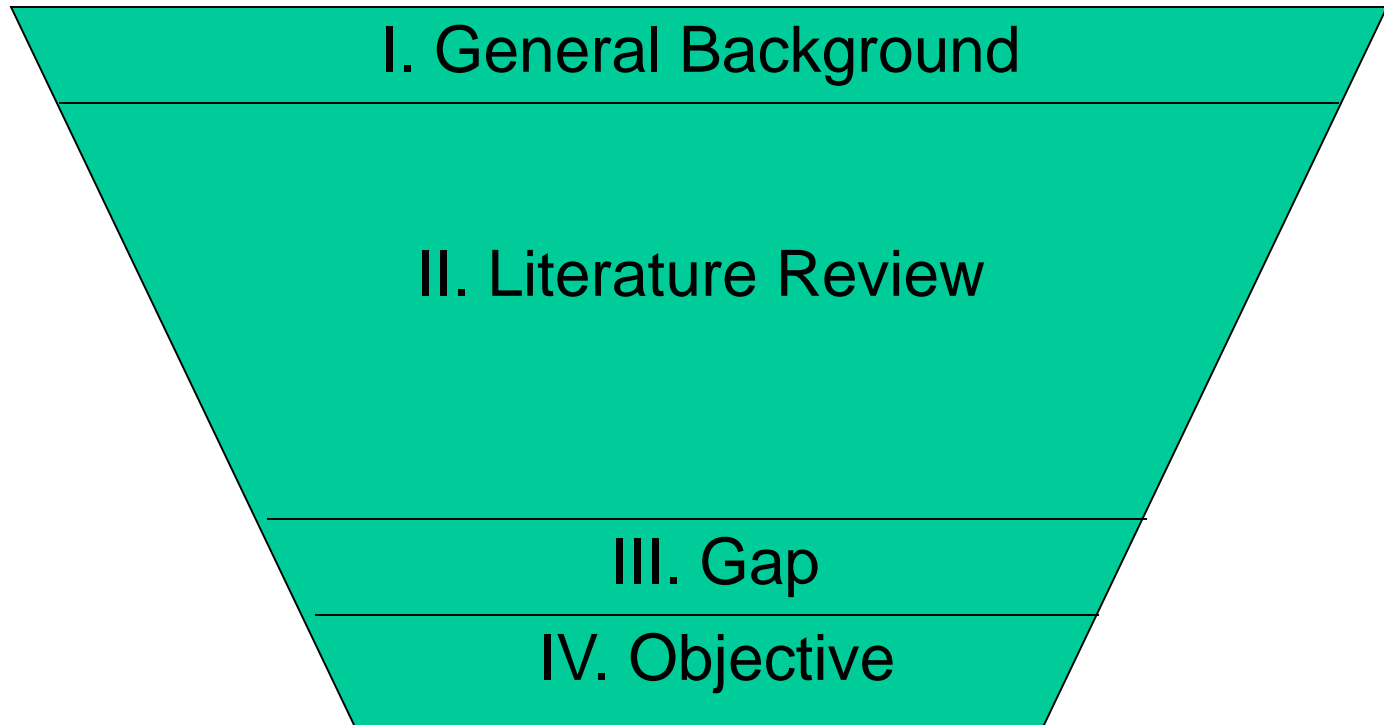
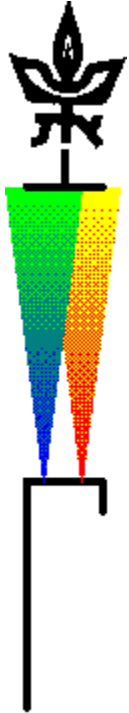

# Introduction

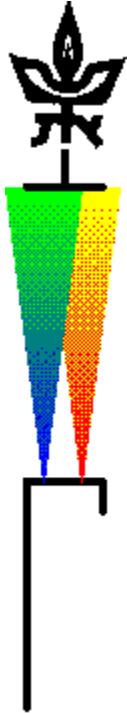

- Introduction and Discussion hardest for the novice to write well !
  - (Exp. Details, Results much more straight forward)
- Objective of the Introduction: give reader sufficient background information so that he can understand and appreciate your work!

# Introduction

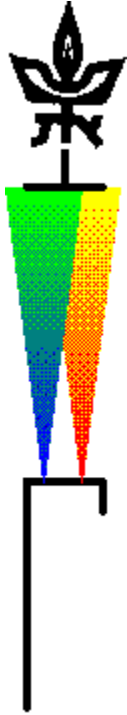

- 4 Required parts:
  - I. General background
  - II. Literature Review
  - III. Gap
  - IV. Statement of Purpose
- 2 optional parts
  - V. Value statements
  - VI. Preview

# Intro: I. General Background

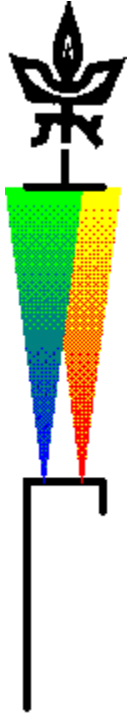

- Purpose:
  - Place paper in broad context
  - Bring reader up to speed
- Style
  - Should be understandable by every reader
  - Defines topic
  - Short (1 par., ~3-5 sentences)
  - Usually very general, non-controversial sentences

# Intro: II. Literature Review

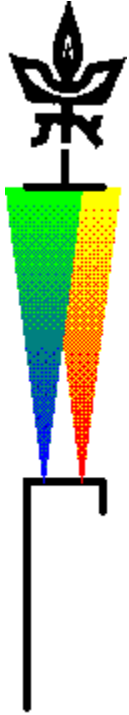

- Purpose
  - Places paper in specific context.
  - Sets the stage for stating what was not done previously (in III) by showing what was done,
- Organization – order citations by:
  - Approach (end with that closest to yours).
  - Relevance (end with most relevant)
  - Chronologically (end with latest)

# Lit. Review, cont'd

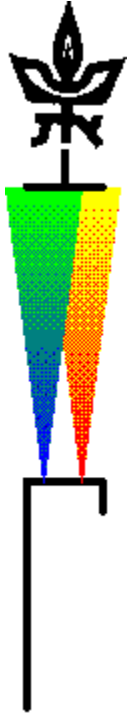

- **DO NOT USE REFERENCE NUMBERS AS WORDS!!!!**
  - NO: **Examples of crack propagation in composite materials are given in [1-4]**
  - Instead: **Crack propagation has been previously investigated [1-4].**
  - If you have to ‘say’ the number for the sentence to make sense, rewrite!
  - Better to cite work by authors name (followed by ref. number). Reader can relate to names – numbers (only) force him to stop reading and search for references at end of paper.

# Lit. Review, cont'd

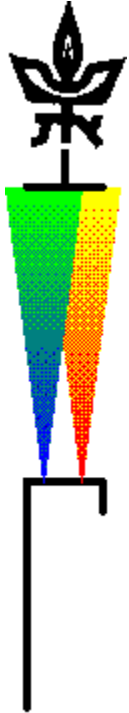

- Your own previous work?
  - Treat your own previous work fairly
  - Referees and readers very suspicious if work of author or author's group cited out of proportion, or work of others ignored.



# Intro. – III. Gap Sentence

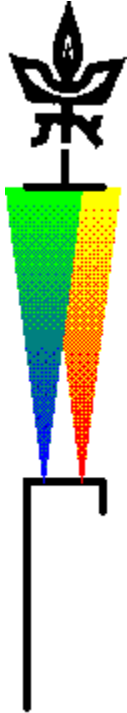

- Summarizes state of knowledge by indicating:
  - What was not done, or
  - Errors in previous work (be careful and tactful!), or
  - Disagreements, controversy between various sources.

# Gap Sentence

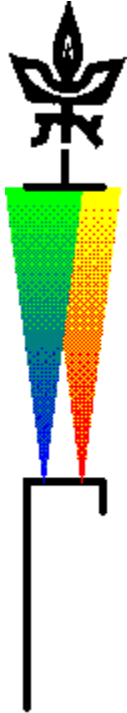

- Most important sentence for getting paper accepted!
  - (most?) common cause for paper rejection – nothing new
  - Gap sentence, by indicating what wasn't done previously, shows that your work is new!
  - **A good gap sentence forces reviewer to work hard to reject paper for lack of novelty**

# Intro. – III. Gap Sentence (cont'd)

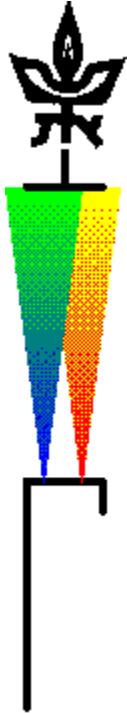

- Usually 1 sentence long
- Always negative
- Must relate to previous papers by you and your group in same manner as other papers
- Sentence should be explicit, precise, and focused:
- Example: “*The dependence of the interface structure between Ti substrates and Al films on the substrate bias voltage has not yet been determined.*”

# Intro. – III. Gap Sentence (cont'd)

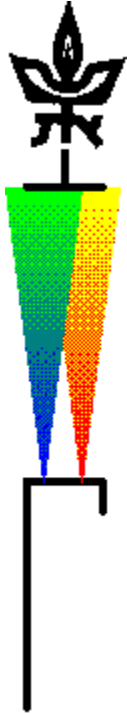

- Don't be wishy-washy
  - “**Few research have investigated.....**”
    - Begg the question – “what about the few?”
    - The “few” should be the focus of the lit. rev., and the gap should be relative to them
  - “**To the best of our knowledge, no one has.....**”
    - It's the authors' job to know the literature!

# Intro. IV-Statement of Purpose

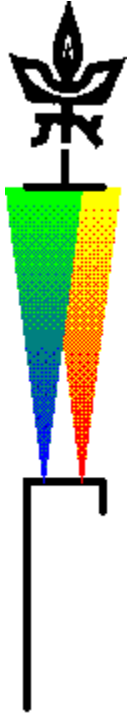

- Immediately follows gap sentence
- States objective of the research/paper, which is, basically, to fill the previously stated gap
- Should be concise, precise, explicit and focused
  - The “research question” should be implicitly clear!
- Example: *“The objective of this research was to determine the dependence of Al/Ti interfaces as a function of substrate voltage during vacuum arc deposition”*

# Intro. IV-Statement of Purpose

- Style notes:
  - The objective of research is not to do research (or study, investigate, etc.)
    - Instead, use more decisive terms – measure, determine, construct, calculate, etc.
  - “research” centered SOP – use past tense
    - The objective of the (research, project, investigation, etc.) was ....
  - “paper” centered SOP – use present tense
    - The objective of this (paper, report, article, etc) is....

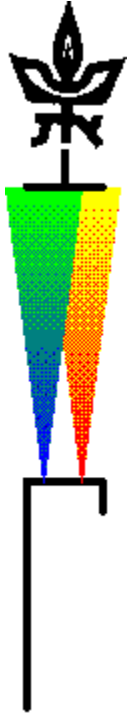

# Intro. – Optional Parts

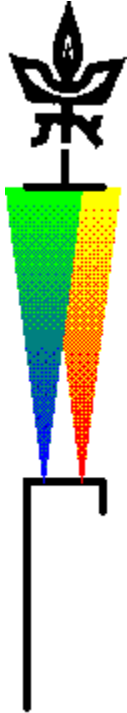

- V. Statements of Value
  - Indicate importance or significance of work
  - Short (1-2 sentences)
  - Modest tone
- VI. Preview
  - Useful for long papers
  - Give principle result
  - Indicate organization

# Experimental Details

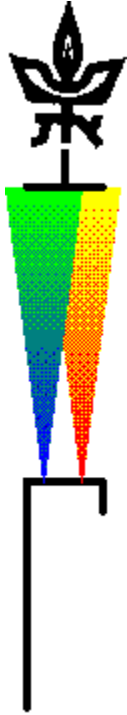

- Sometimes called:
  - Experimental Apparatus and Procedure
  - Methods and Materials (bio, med)
- Do not call it ‘**Experimental**’ (an adjective -- a title must include a noun)
- Answers the question “what did I do?”



# Experimental Details

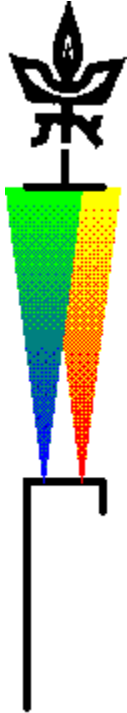

- Amount of detail: absolutely must include sufficient detail so that every result presented can be duplicated elsewhere
  - If you have secrets necessary to get the results, don't publish!
- Nice to report details which would help your readers
- Eliminate extraneous detail

# Experimental Details

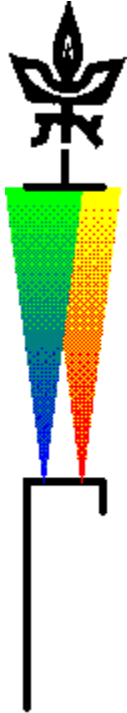

- Start with Apparatus
- Standard or well-known apparatus – mention, define, give ref., as appropriate
- Non-standard, not well-known, - describe
  1. Define purpose
  2. Give brief overall description (use a diagram)
  3. Describe parts

Some logical order (signal or material flow, left-right, top-bottom, etc.)
  4. Describe inter-relation of parts, operation.

# Apparatus Diagrams

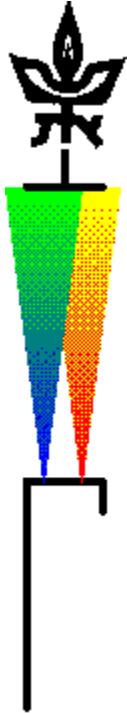

- Schematic – show only parts necessary to understand operation
  - All parts mentioned in text should be labeled in diagram
  - All unusual parts in diagram should be described in text
- No workshop drawings
  - too detailed
  - lines too thin
- No photographs
  - Easier to understand schematic drawing

# “Heads-up Display”

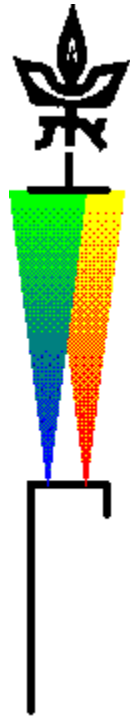
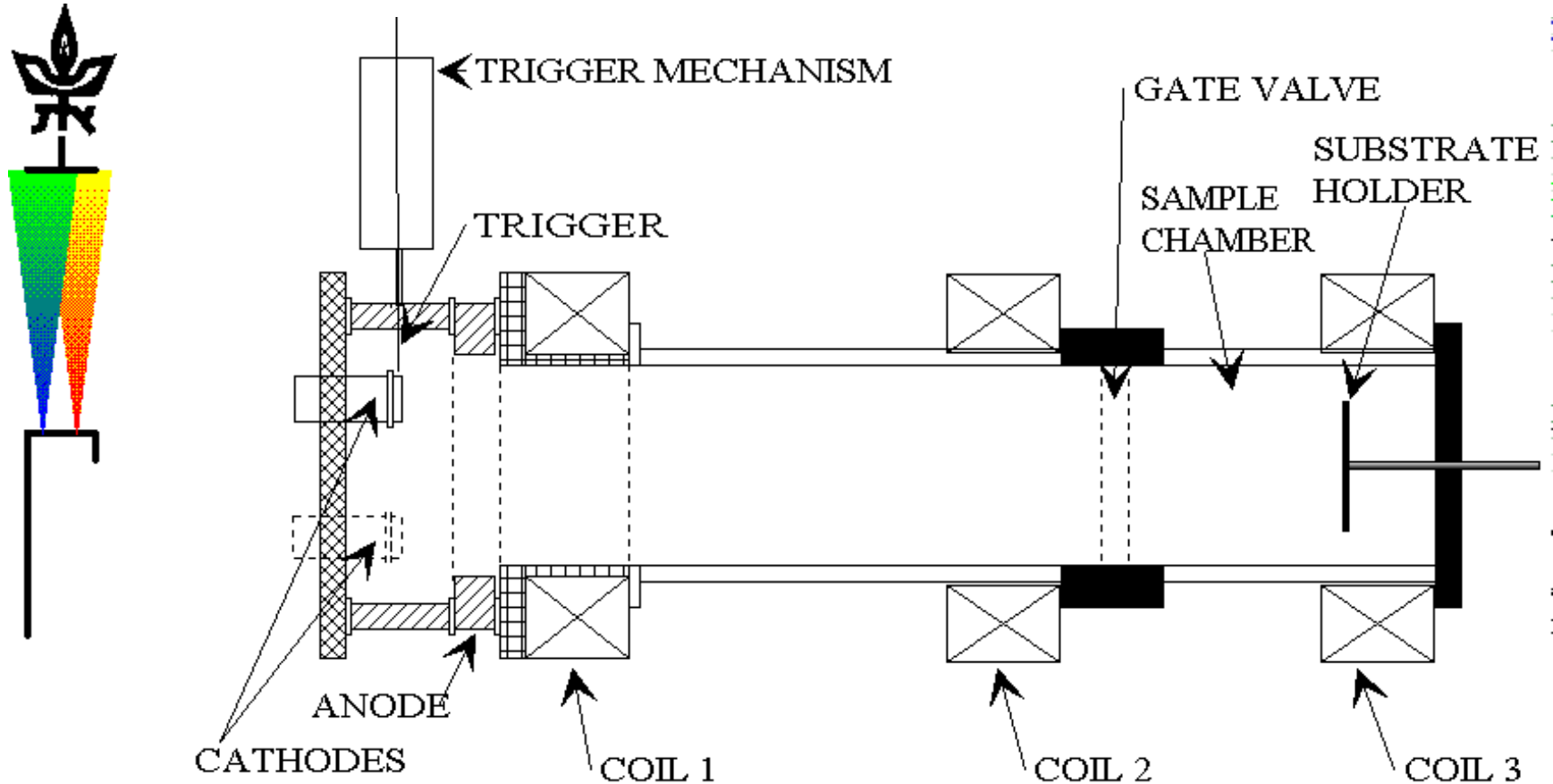

# Eye-tiring figure: Eye needs to jump back and forth from fig. to caption or text

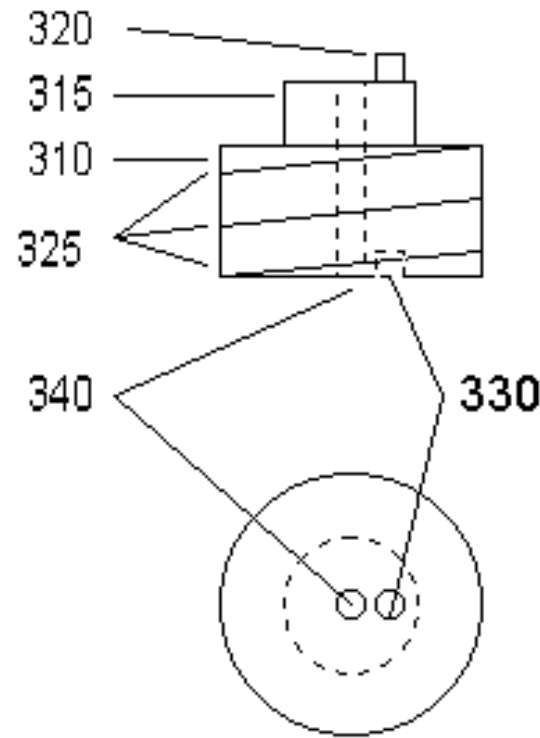
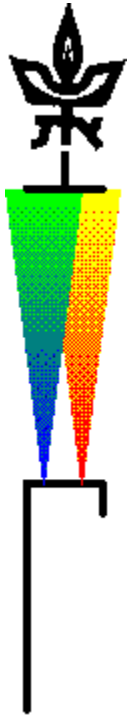

# Exp. Details – Style and Grammar

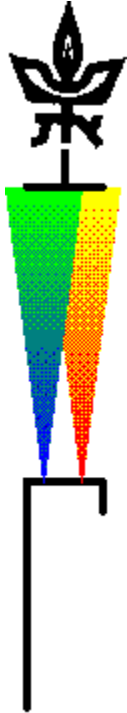

- Usually past tense
  - present tense for general truths, generic description of standard equipment
- Voice
  - Human agent – passive (avoid I, we, etc.)
    - The voltage was adjusted (*by the experimenter*) to 15.4 V.
  - Instrumental agent – active or passive
    - The generator produced a series of 50 V, 50 ns pulses.
    - A series of 50 V, 50 ns pulses was produced by the generator

# Exp. Details – Style and Grammar

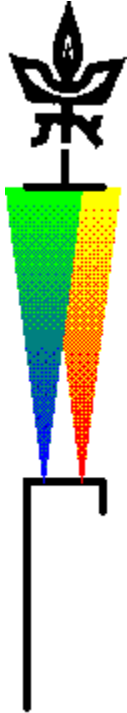

- Articles
  - First mention of a part – use “a/an”
  - Subsequent mention – use “the”
- Word order
  - Start with old information (i.e. part already described), then give new information

Example: Ions were produced with **a** Kaufman source. **The** source was positioned 25 cm from the substrate surface.

# Exp. Details – Exp. Procedure

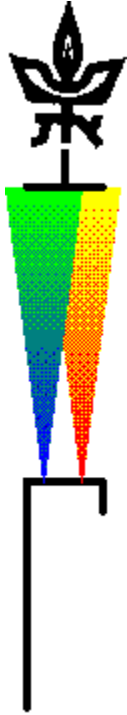

- Sequence of events followed to conduct experiment
  - Give sufficient detail to duplicate results
  - Don't give unnecessary detail
- Specify all experimental conditions/parameters required to duplicate results (e.g. pressure, temperature, voltages, fields, flows, etc.)
  - Give specific common, fixed values
  - Indicate range of variable parameters
  - Often a table summarizing exp. parameters is useful



# Table summarizing parameters and experimental variables

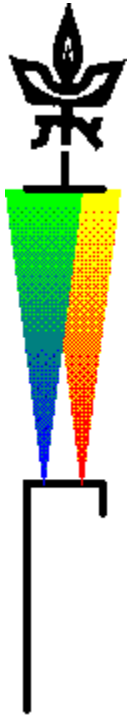

## Fixed Parameters

Cathode diameter

**Value**

50 mm

Anode i.d.

160 mm

Axial Magnetic Field

100 mT

## Variables

## Symbol

**Value**

Cathode Materials

Zr, Hf, Ti

Cathode Current

I

50-150 A

Deposition Time

$T_d$

60-180 s

# Theoretical Papers – Model Assumptions, Derivation of Equations

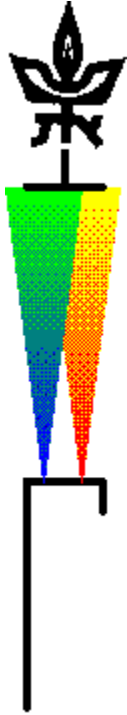

- Also answers “what did I do?”
- State all assumptions first, then develop equations
- Give sufficient detail for duplication elsewhere
  - Shouldn’t need to work weeks to progress from one equation to the next!

# Theoretical Papers: Nomenclature

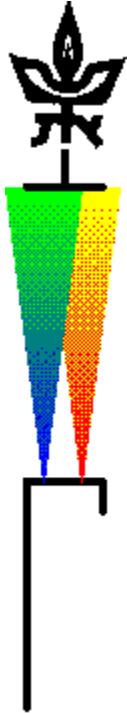

- Define each symbol
  - Either 1st time used, or
  - In Nomenclature Table
- Recommendation – Prepare Nomenclature Table for internal use. 4 Columns:
  - Symbol
  - Definition
  - Pages upon which it appears
  - Page containing definition

# Results

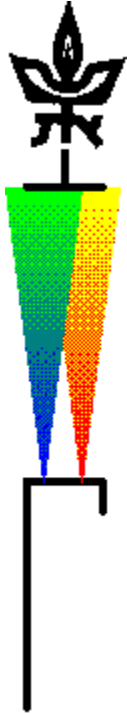

- Answers the basic question, “What did I get” or “What did I observe”
- Typically, most results given in tables and figures. Text revolves around them.

# Results, cont'd

- **Three Information Elements – types of sentences**

*Location* (L) sentences indicates which figures or tables contain a particular result.

*Presentation* (P) sentences present the most important findings.

*Comments* (C) are sentences which comment on the results.

- Sometimes L&P are combined in a single sentence.
- Never combine C with anything else.

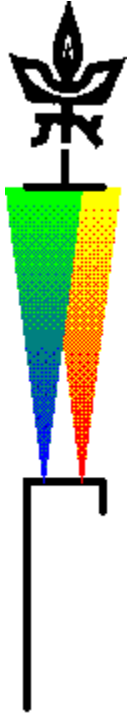

# Results, cont'd

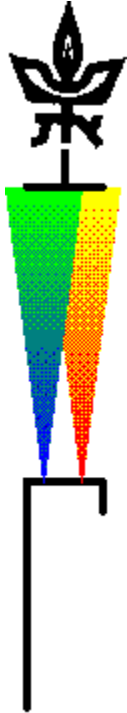

type	example
L	The correlation parameters as a function of distance from the jet outlet is shown in Fig. 3.
P	It may be seen that the correlation decreases steeply with distance, and becomes negligible after 5 cm.
C	This results differs significantly from those observed with conventional jets.
L&P	The wavelet intensity has a Gaussian temporal profile, whose width decreases with the distance between the sources, as may be seen in Fig. 4.
C	This is similar to the results from ring sources.
L&P	The wavelet intensity has a Gaussian temporal profile, whose width decreases with the distance between the sources (Fig. 4).
L	Table 5 summarizes the composition and wear properties of coatings deposited under various conditions.

# Results - Style and Grammar

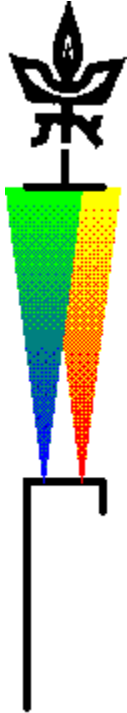

- Location sentences
  - In present tense
  - Both active & passive OK
- Presentation sentences
  - Report results not in figures or tables
  - Summarize most important results of tables and figures – “Blind man’s rule”
  - Usually use past tense
  - Be precise, and as quantitative as necessary/possible

# Increasing Information in Presentation Sentences

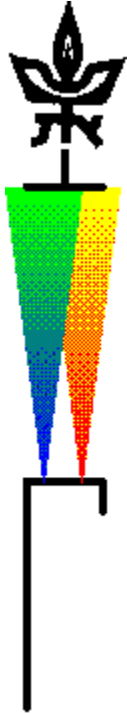

1. It may be seen that Y depended on X.
2. It may be seen that Y increased with X.
3. It may be seen that Y increased linearly with X.
4. It may be seen that  $Y \approx 22.3 X + 32$ .



# Results - Style and Grammar

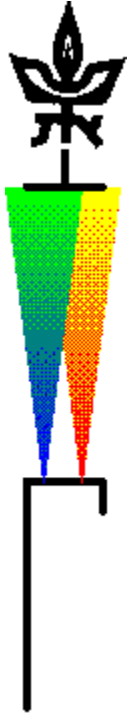

- Comment sentences:
  - Only comments intimately related to specific finding.
    - Put more general comments in Discussion!
  - Don't mix 'facts' (i.e. results) with interpretations, speculations, etc.
    - Put these in the Discussion

# Results – all the conditions!

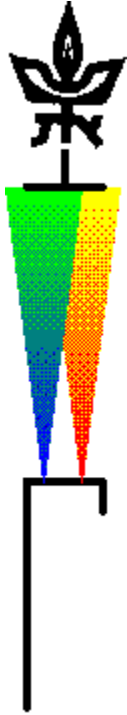

- Be sure that all the conditions, parameters, etc., required to obtain a particular result (e.g. in a specific figure) are given!
- If the conditions are not completely specified in “Experimental Details” (e.g. if there were variable parameters), then they must be given either in Location sentence, caption or figure
- Always give conditions first, then the result.
  - 1<sup>st</sup> - what you did,
  - 2<sup>nd</sup> - what you got

# Results – figures and tables

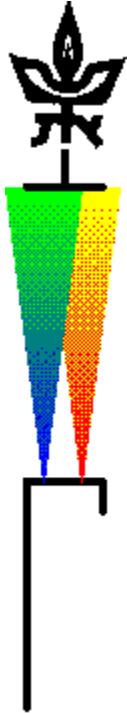

- Choose most appropriate format to make your point
  - Tables where absolute value is most important
  - Graph where trend is most important
  - Choose x axis so it (and not a parameter) represents the most important variable

# Results – figures and tables

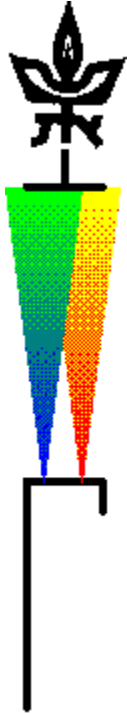

- Heads-up display – all required info on the graph (if possible), rather than in caption or text
- But - don't crowd
- Illiterate man's rule
  - Figures should be understandable to an illiterate!
- Don't be lazy – author should work, not reader
- Always specify units .
  - **Do not use** V, **×1000**

# Discussion

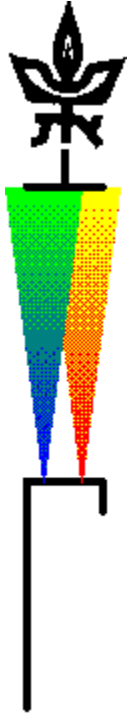

- Answers the question “So what?”
- **Typical Elements in the Discussion**
  - **Specific reference to the present study:**
    - 1. Reference to the main purpose or hypothesis
    - 2. Review of the most important findings
    - 3. Limitations and justifications:
      - \* demonstration of self-consistency (e.g., with model assumptions)
      - \* demonstration of statistical validity
      - \* technique limitations, and their implications (e.g., bandwidth of instrument→high frequency components, if existent, cannot be observed)

# Discussion, cont'd

- 4. Comparisons
  - \* between different elements of the present studies
  - \* with previous works (between various theories, between various experiments, between experiment and theory, or theory and experiment)

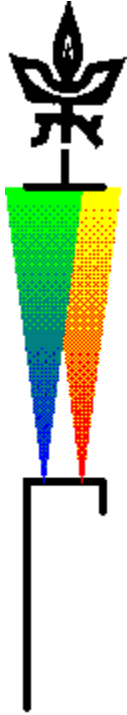

# Discussion, cont'd

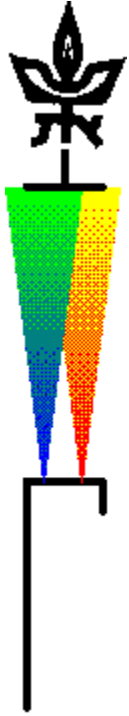

## – General statements

- 5. Implications and generalizations
- 6. Recommendations
  - \* for future research
  - \* practical applications
- In general, discussion starts with specific statements re. present study, and diverges towards more general statements.

# Discussion, cont'd

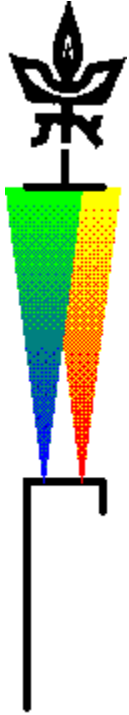

- Major problem – correctly conveying degree of certainty (of explanation, implication, etc.)
  - Faulty or absent analysis by author
  - Wrong choice of words
  - Its o.k. to offer speculative explanation, if
    - clear to the reader that it's a speculation
    - short



# Certainty Scale

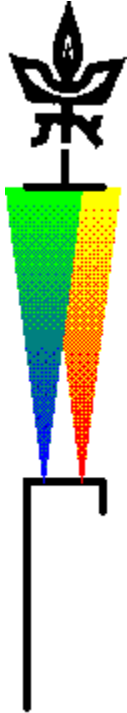

<b>category</b>	<b>use</b>	<b>key words</b>
speculation	idea or ideas that come to mind	may, possible, conceivably
likely	some evidence supports this idea	suggests, indicates
very likely	substantial evidence supports this idea	is consistent, strongly suggest
most likely	There is more evidence and/or theoretical support for this idea than any other existing idea	most likely
proven	All possible explanations are on the table, and a decisive test indicates that this idea and only this idea explains the observation	proven, proves, proof, shown, demonstrated

# Discussion

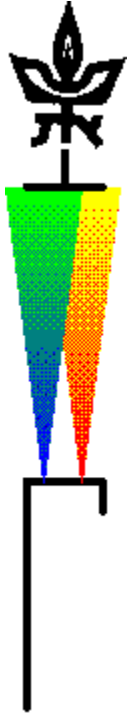

- **Don't introduce “new” results in the Discussion !!!**
  - Don't present “new” facts in the discussion!!!
  - The discussion should discuss results presented earlier in the paper, or in the literature (with a specific reference).

# Conclusions

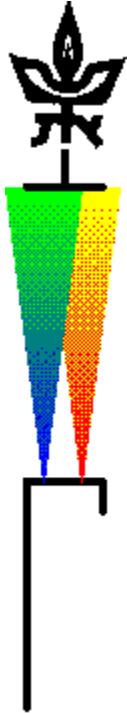

- May be the concluding paragraph of the discussion
- or separate section, entitled “Conclusions”, or “Conclusions and Recommendations”
- Should be very short (1-2 paragraphs)
- Don’t repeat objectives or methodology
- Don’t use indicative sentences  
(e.g. *The microhardness and critical load were measured as functions of the substrate temperature.*)

# Conclusions

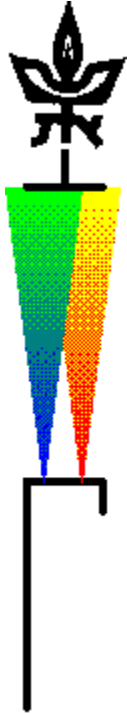

- No “new” information – this section should summarize results and ideas which are presented and developed in detail in previous sections (i.e. results and discussion).
- Summarize the most important results, and their implications. (again this is a summary, the implications should have been developed and discussed in Discussion).
- Think in terms of 3 things you want the reader to remember

# Conclusions

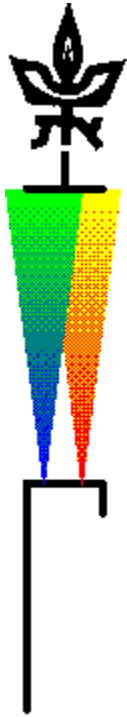

- The conclusions must contain the answer to the “research question”, (or an “admission of failure”, in which case perhaps the paper should be rewritten around a more modest research question).
- Should be self-contained – avoid references (either internal (*e.g. see Fig. 3*) or external)
- Recommendations may be offered for further work. They should be firmly based on the present work.

# Abstract

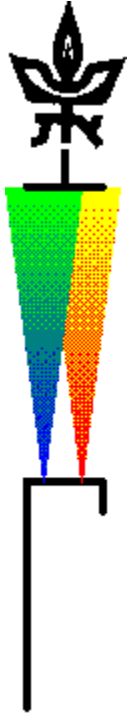

- Write draft before writing body of paper
- Re-write when done
- Summarizes in 1-2 sentences each:
  - 1) background,
  - 2) objective
  - 3) methodology
  - 4) most important results
  - 5) conclusions

# Abstract, cont'd

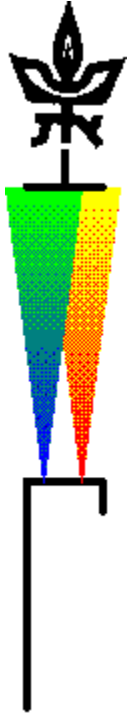

- Many read only abstract (abstract journals),  $\therefore$  make it informative, not merely indicative
  - $\Rightarrow$  Indicative example: **The voltage as a function of temperature was measured.**
  - $\Rightarrow$  Informative example: *It was found that the voltage decreased as a function of the temperature, reaching a saturation value of 30 mV.*

# Abstract, cont'd

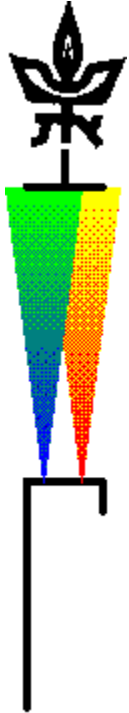

- Abstract should stand alone – no references.
- Abbreviations:
  - use only if a term is used repeatedly *within the abstract*,
  - and its use will save considerable space.
  - Define each abbreviation the first time it is used.



# Title

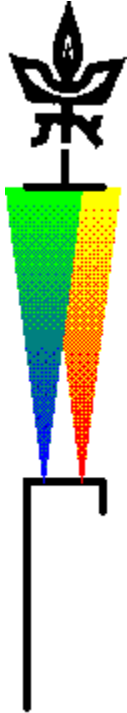

- Compose title and detailed outline at the beginning of the writing process
- Re-evaluate and correct title after the paper is written
- Short (<2 lines, 1 is better)
- Accurately express the subject of the new results presented
- No abbreviations!!!

# Summary – 10 Commandments for writing a good paper

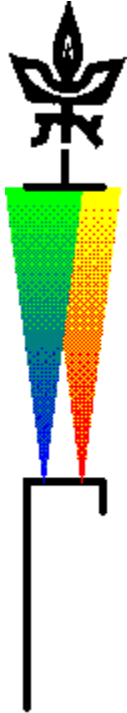

1. Have a well defined ‘research question’
  - Implicit in ‘statement of purpose’ in intro.
  - Answered in conclusions
2. Organize paper in standard manner  
(Introduction, Experimental Apparatus and Method, Results, Discussion, Conclusions)
  - Prepare an outline before writing text
  - Put each statement into the right place

# Summary – 10 Commandments

3. Explicit gap sentence in introduction
4. Give all the details required for duplicating results
5. Results: Location, Presentation, Comment
6. Good graphics – easy to read and understand
7. Be modest in explanations, implications
8. Polish each sentence
9. Informative abstract
10. Work hard to make readers' job easy

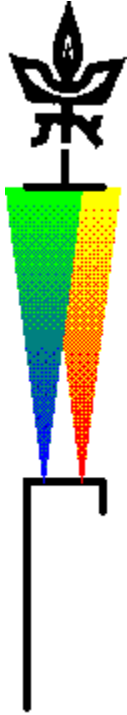

# Thanks for your attention!

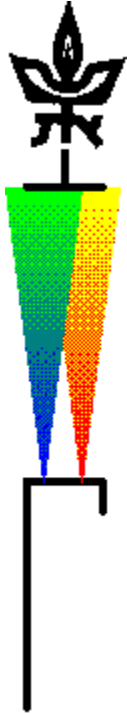

- Want more?  
**Read the book!**
- <https://www.worldscientific.com/worldscibooks/10.1142/10145>

