

# Particle accelerators, instruments of discovery in physics

Philippe Lebrun  
Director, Joint Universities Accelerator School

JUAS, 18 February 2020

## Foreword

- The aim of this lecture is to illustrate the joint evolution of elementary particle physics and their essential tools, the particle accelerators, cross-fertilized by the «pull» of the former and the «push» of the latter, throughout the 20<sup>th</sup> and beginning of the 21<sup>st</sup> century
- The presentation approximately follows chronological order, though with some necessary deviations imposed by the non-linear developments in the history of science and technology
- Not all the major discoveries in particle physics, and not all the major high-energy accelerators are discussed; rather, the lecture addresses a selection of salient cases deemed of interest to the purpose of the discussion
- The lecture is targeted to students of accelerator physics and technology, not of particle physics

## Isaac Newton *Opticks* (1704)

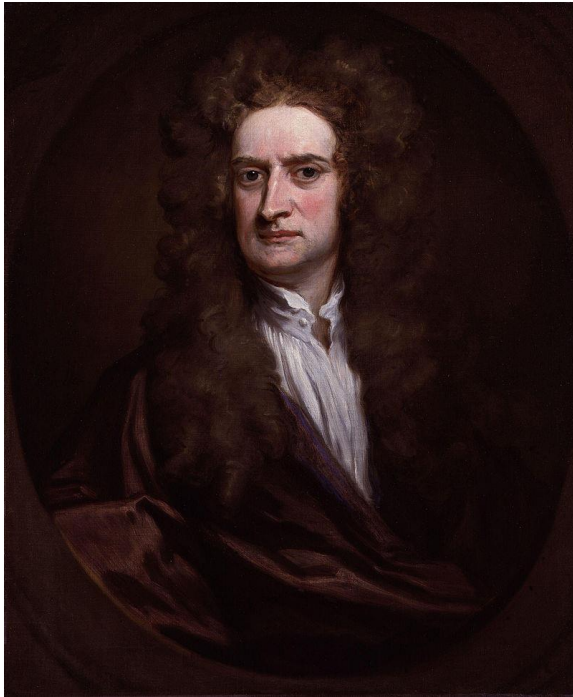

*There are agents in Nature able to make the particles of bodies stick together by very strong attractions. And it is the business of Experimental Philosophy to find them out. The smallest particles of matter may cohere by the strongest attractions.*

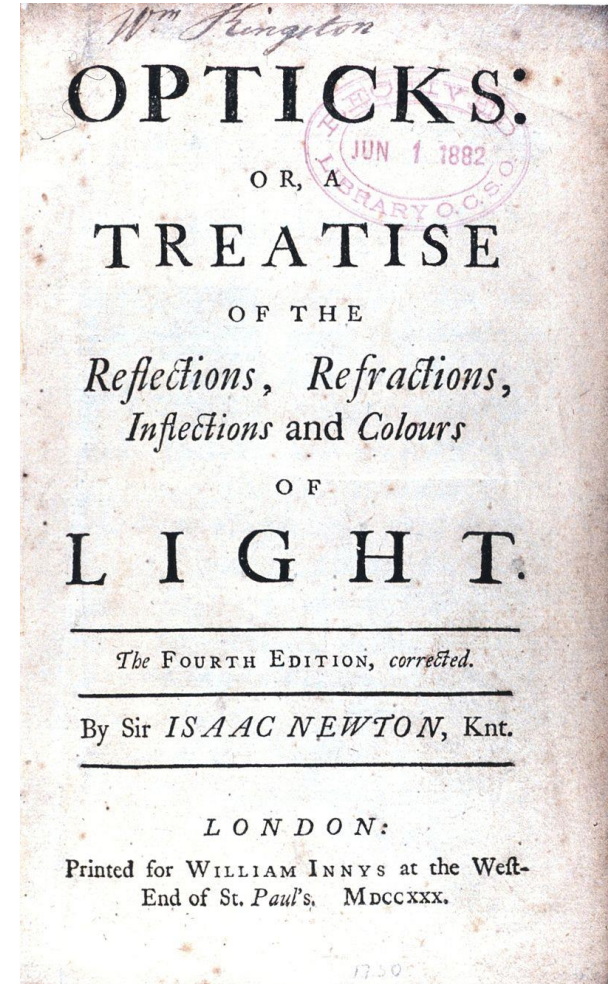

## John Dalton

### *A New System of Chemical Philosophy (1808)*



John Dalton introduces atoms to explain why elements always react in ratios of small whole numbers

*Chemical analysis and synthesis go no farther than to the separation of particles one from another, and to their reunion. No new creation or destruction of matter is within the reach of chemical agency... All the changes we can produce consist in separating particles that are in a state of cohesion or combination, and joining those that were previously at a distance*

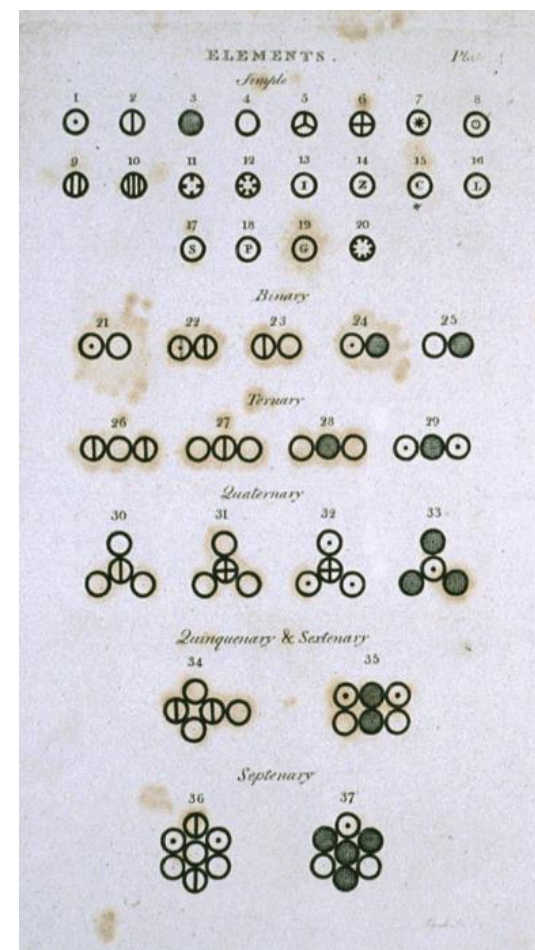



## Crookes tubes to study «cathode rays» (ca 1870) From electrical discharge in rarefied gases to beams of particles

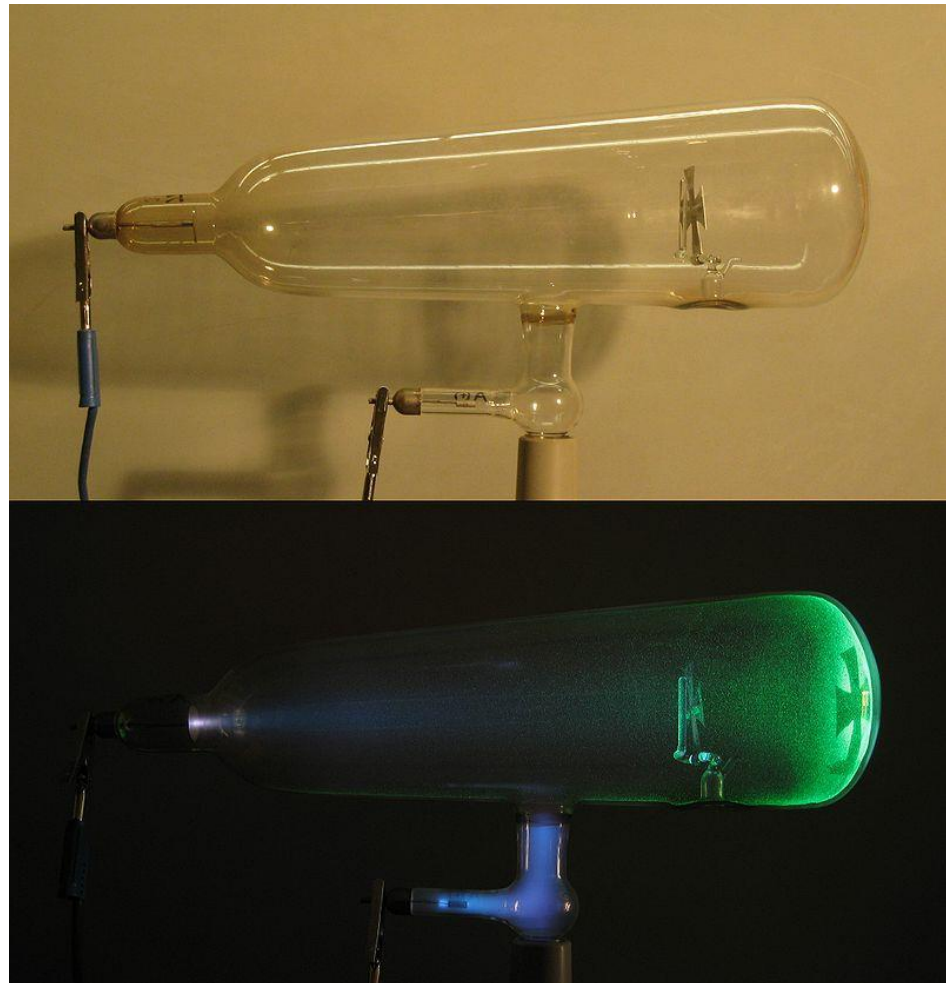
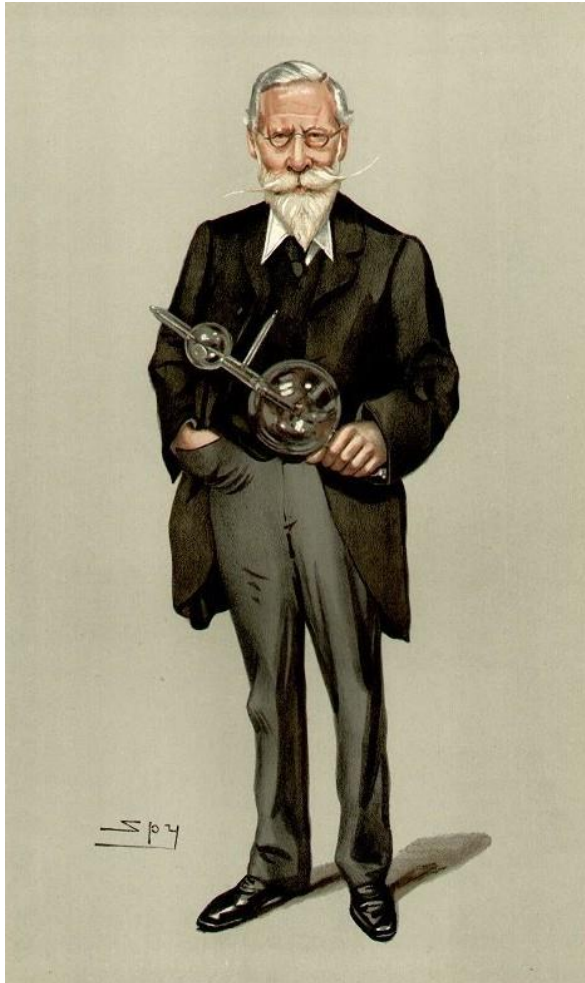

## Roentgen (1896) First radiograph of hand

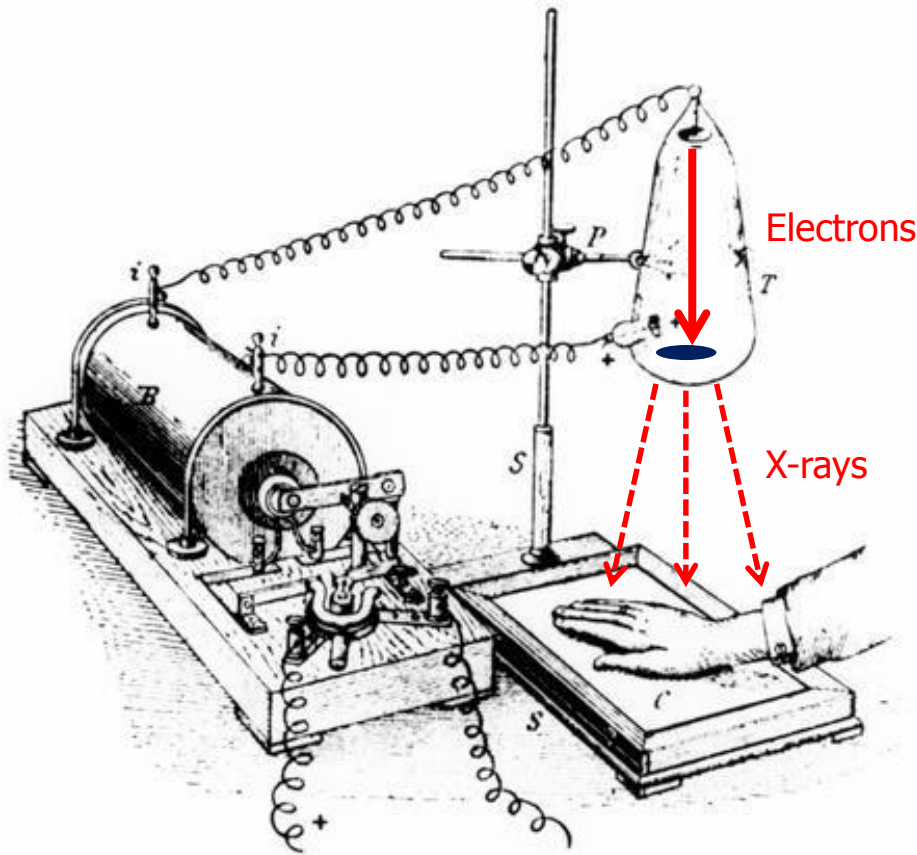

The first application of accelerators for society

## J.J. Thomson experimenting with Crooke's tubes

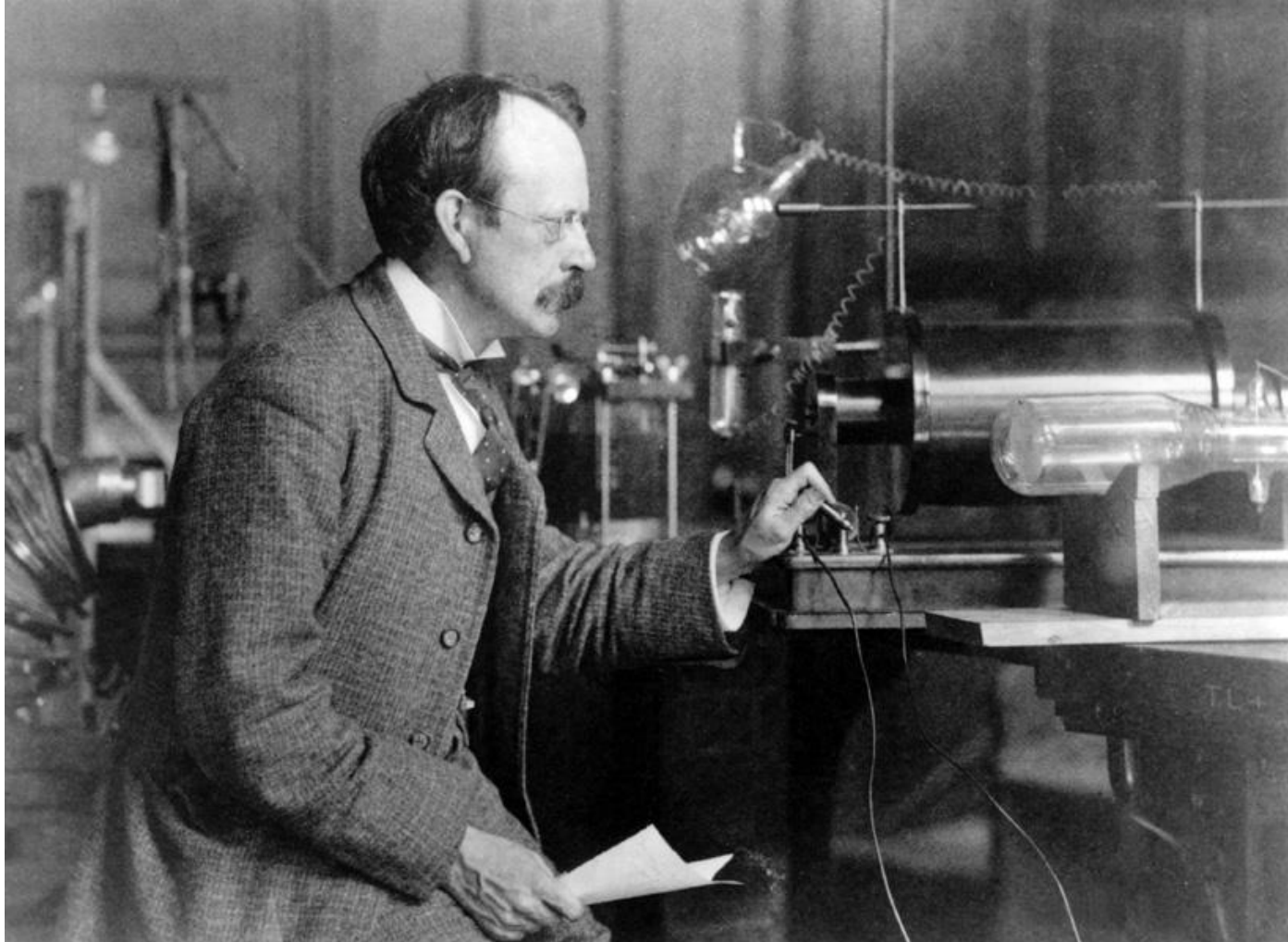



## J.J. Thomson experimenting with Crooke's tubes

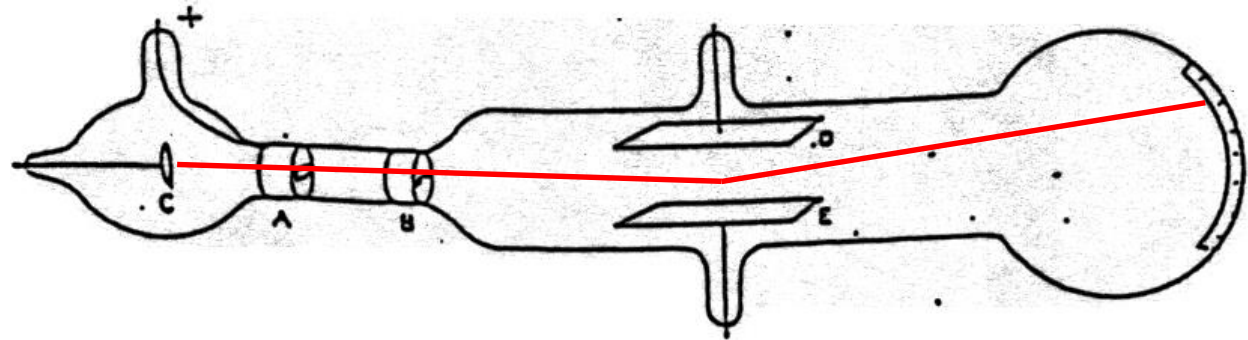

- «Cathode rays» are deviated by electrical and magnetic fields
- Deviation is independent of the cathode material and gas species in the tube

*As the cathode rays carry a charge of negative electricity, are deflected by an electrostatic force as if they were negatively electrified, and are acted on by a magnetic force in just the way in which this force would act on a negatively electrified body moving along the path of these rays, I can see no escape from the conclusion that they are charges of negative electricity carried by particles of matter.*



## Discovery of the electron (1897) First model of the atom

- Applying sequentially electric and magnetic fields enables to measure the charge-to-mass ratio  $e/m$  of the particles
- Electric field  $E$  deflection  $\theta = Ee\ell/mv^2$
- Magnetic field  $B$  deflection  $\varphi = Be\ell/mv$

where

- $\ell$  is the path length over which the fields are applied
- $v$  is the particle velocity

- Setting the fields such that  $\theta = \varphi$  one can calculate  $e/m = E\theta/\ell B^2$
- The measured charge-to-mass ratio is constant, independent of the nature of the gas and of the material of the electrodes  $\Rightarrow$  the electron, elementary particle carrying negative charge
- Matter is electrically neutral  $\Rightarrow$  «plum-pudding» model of the atom

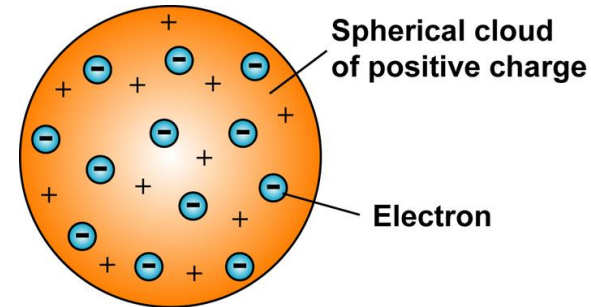

## Cavendish Laboratory, Cambridge University (end 19<sup>th</sup> century)



## Manchester University Physics Department 1910

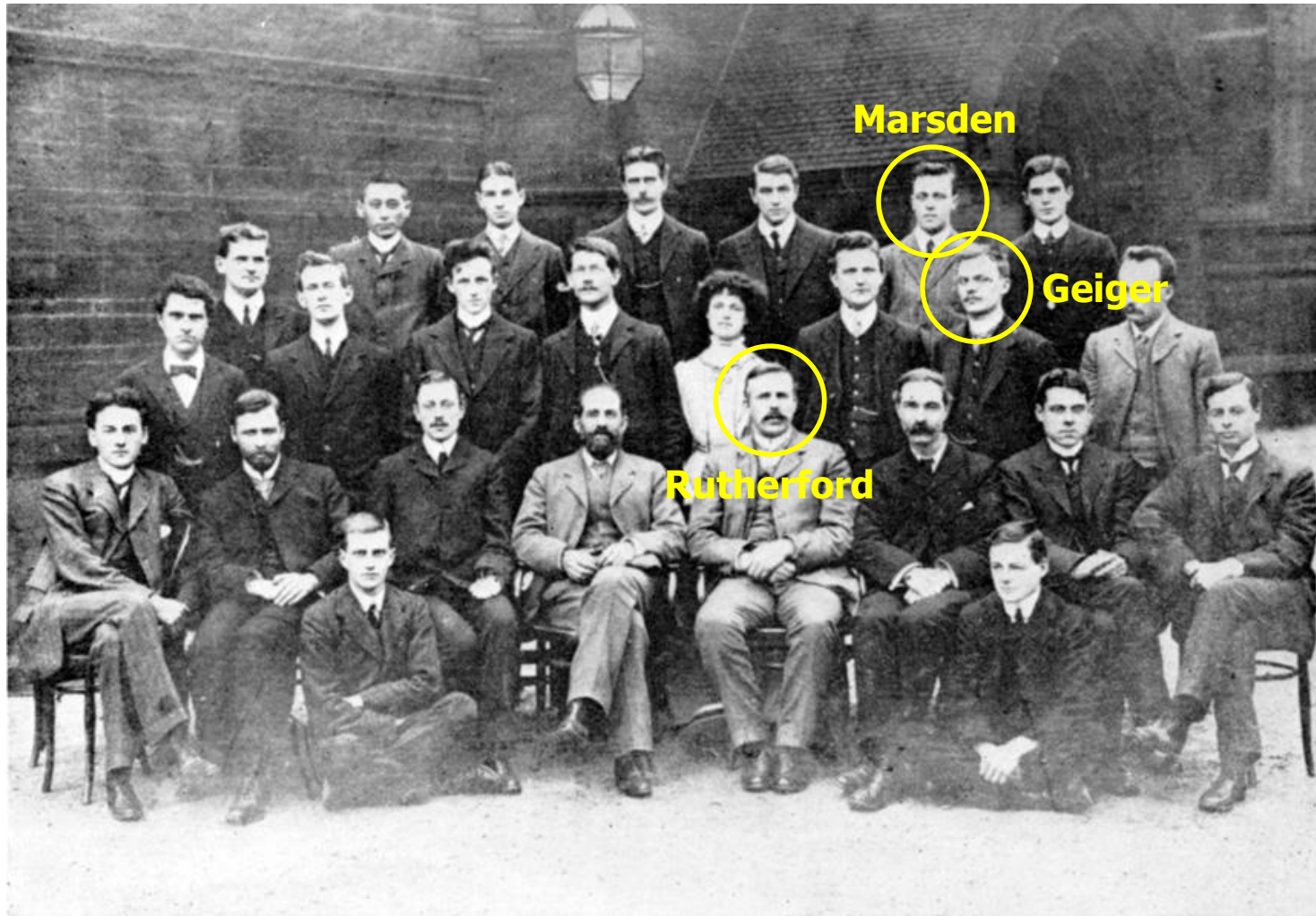

# The nuclear scattering experiment

## Rutherford, Geiger & Marsden 1911

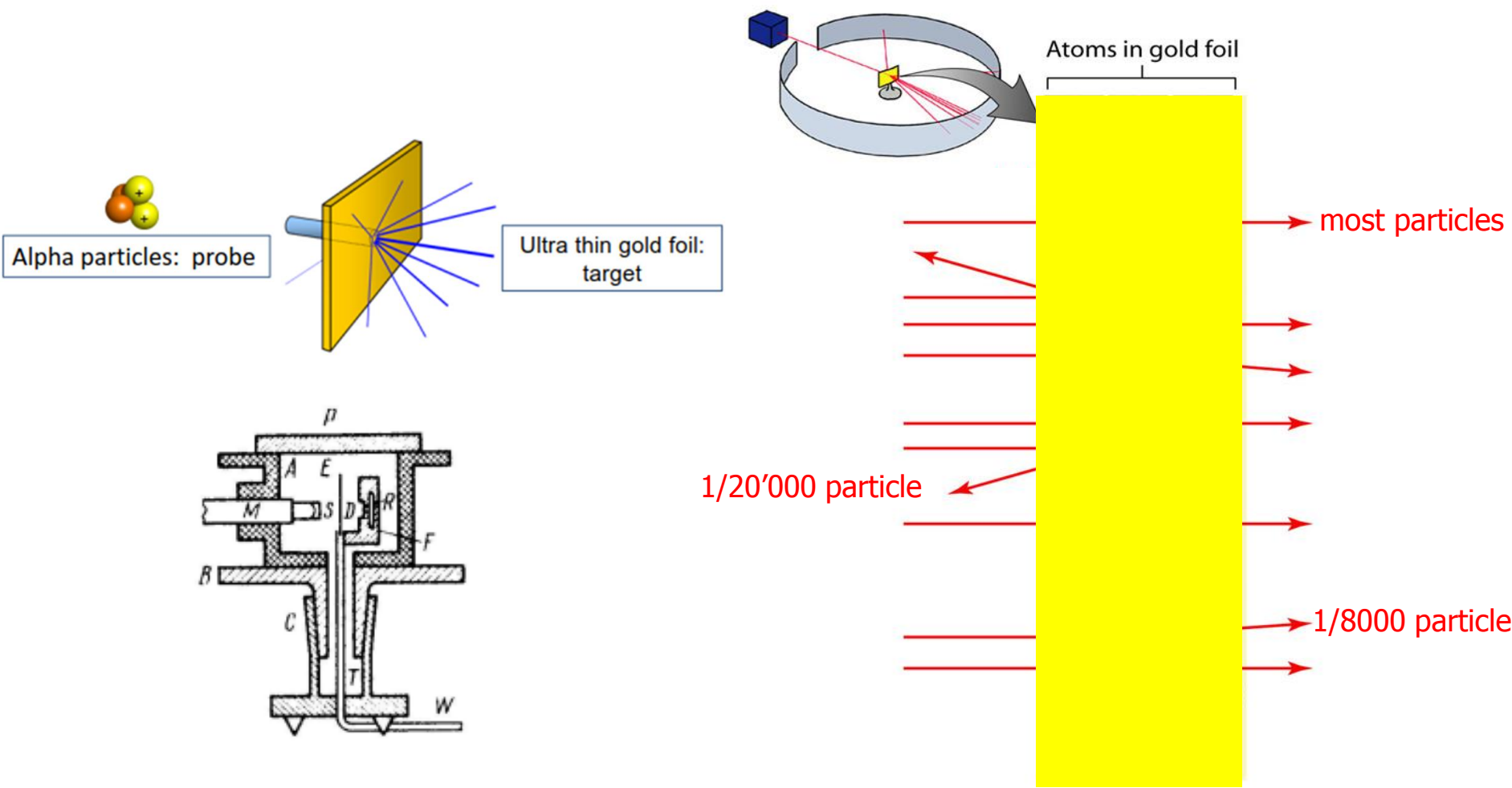



## Rutherford's analysis of the structure of the atom

*Theory of structure of atom*

Suppose atom consists of + charge  $Ne$  at center + - charge as electron distributed throughout sphere of radius  $a$ .

Force at  $P$  on electron =  $Ne^2 \left\{ \frac{1}{a^2} - \frac{4}{3} \frac{1}{a^3} \frac{1}{a^2} \right\}$

$$= Ne^2 \left\{ \frac{1}{a^2} - \frac{4}{3} \right\} = \neq \neq$$

Suppose charged particles  $e$  move through atom so that deflection is small but  $\perp^2$  distance from center =  $a$

deflecting force  $\perp^2$  direction from center at  $P$

$$= Ne^2 \left\{ \frac{1}{a^2} - \frac{4}{3} \right\} \cos \theta$$

and  $\perp^2$  distance of path =  $dd = \frac{Ne^2}{m} \left\{ \frac{1}{a^2} - \frac{4}{3} \right\} \frac{a}{v}$

When  $u$  is assumed unchanging  $\frac{dv}{dt}$  about  $\perp^2$  distance

$$u = \int dd \cdot dt = Ne \int a \cdot \frac{ds}{v}$$

$$= \frac{Ne^2}{m v} \int \left( \frac{1}{a^2} - \frac{4}{3} \right) \frac{a}{v} \cdot \frac{a dv}{v^2 - u^2}$$

$$= \frac{2Ne^2}{m v} \int \frac{a^2 (1 - \frac{4}{3} \frac{v^2}{u^2})}{v^2 (v^2 - u^2)} dv$$

$$= \frac{2Ne^2}{m v} \int \left[ \frac{1}{v^2} - \frac{4}{3} \frac{1}{v^2} \frac{v^2}{u^2} \right] \frac{dv}{v^2 - u^2}$$

*We have been able to get some of the alpha-particles coming backwards...It was quite the most incredible event that has ever happened to me in my life. It was almost as incredible as if you fired a 15-inch shell at a piece of tissue paper and it came back and hit you. On consideration, I realized that this scattering backward must be the result of a single collision, and when I made calculations I saw that it was impossible to get anything of that order of magnitude unless you took a system in which the greater part of the mass of the atom was concentrated in a minute nucleus. It was then that I had the idea of an atom with a minute massive center, carrying a charge.*

Ernest Rutherford

## Ernest Rutherford advocates the use of accelerators

*It has long been my ambition to have available for study a copious supply of atoms and electrons which have an individual energy far transcending that of the alpha and beta particles from radioactive bodies. I am hopeful that I may yet have my wish fulfilled, but it is obvious that many experimental difficulties will have to be surmounted before this can be realised on a laboratory scale.*

Anniversary Address of  
the President of the Royal Society (1927)

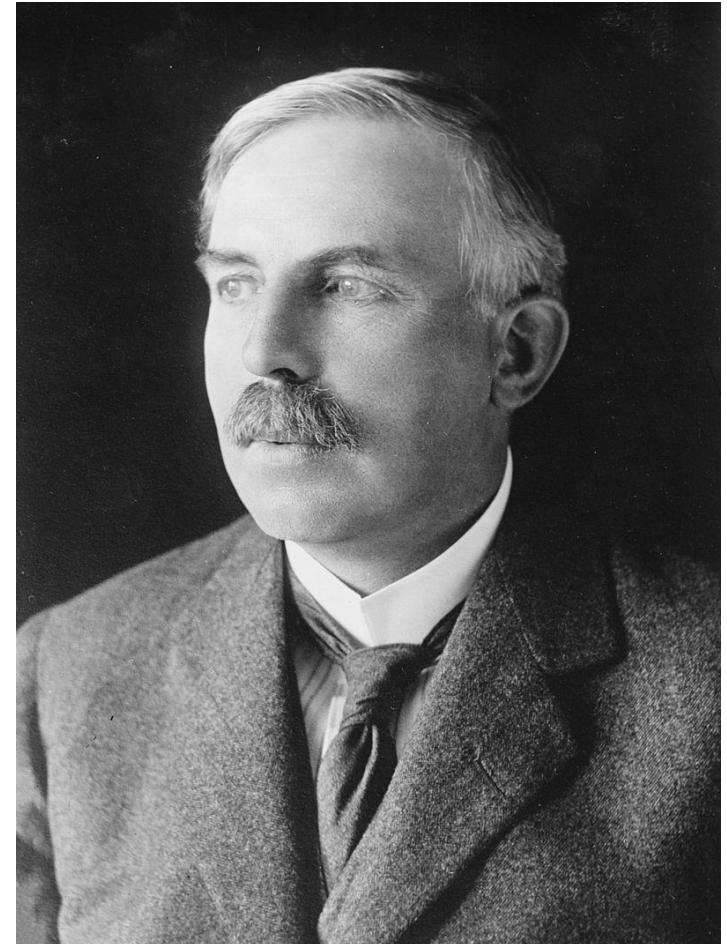

## Electrostatic accelerators: Cockcroft & Walton

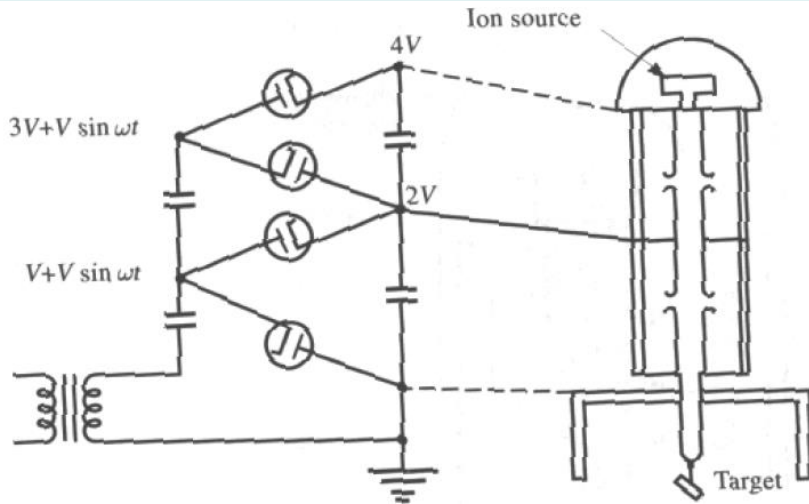

J.D. Cockcroft



E.T.S. Walton

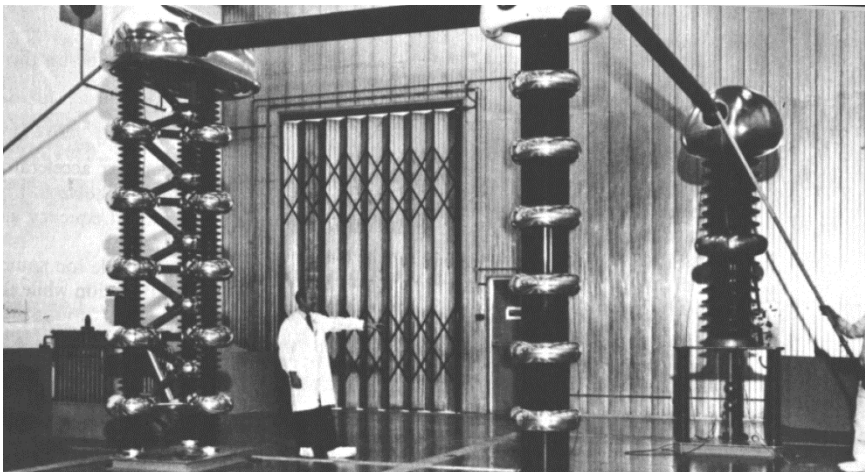

- Voltage multiplication by AC to DC conversion along the ladder
- Theoretical maximum voltage
 
$$V_{DC} = 2 N V_{AC}$$
 N number of stages
- Accelerating voltage up to several hundred kV



## First breaking of the atomic nucleus by Cockcroft & Walton (1932) Nobel Prize 1951

- Shoot accelerated protons onto lithium target
- For incident energy above 125 keV

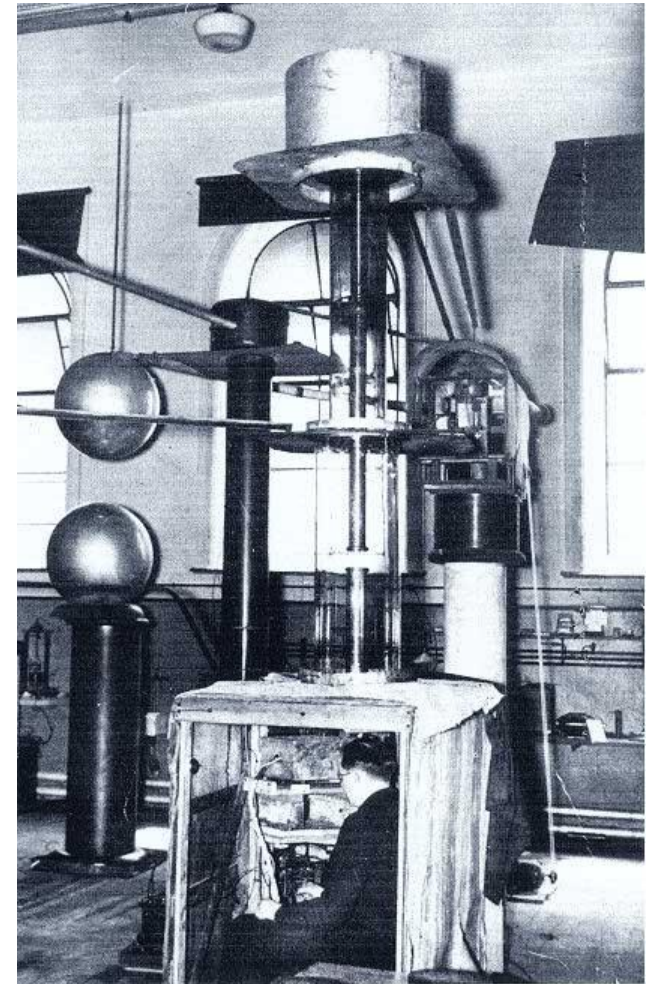
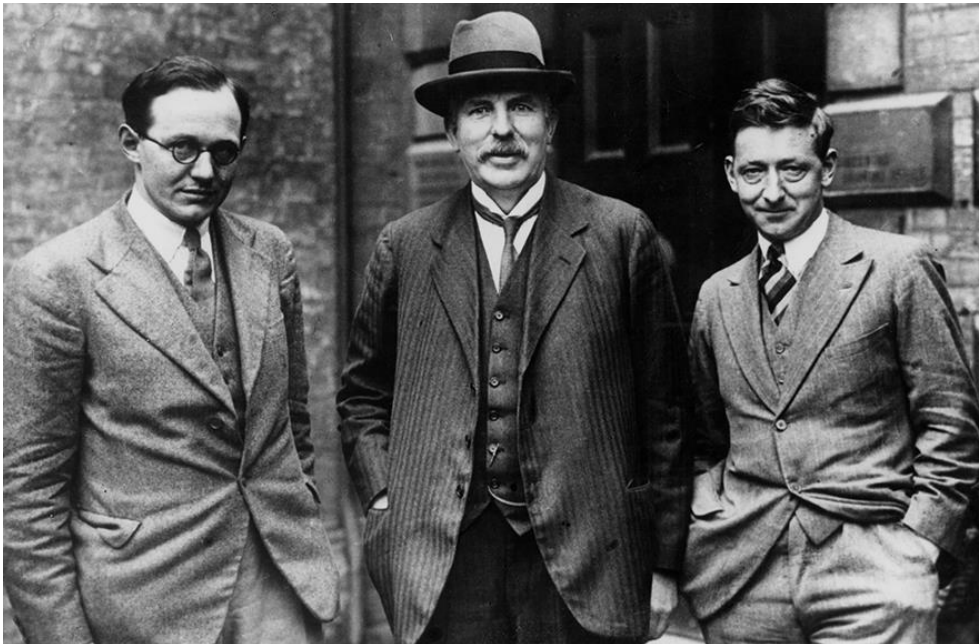
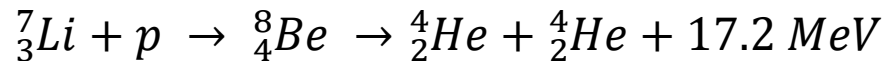



## Electrostatic accelerators: Van de Graaf

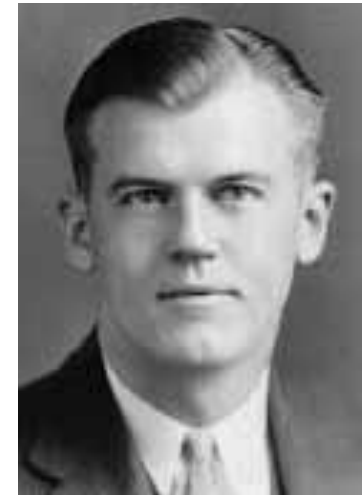
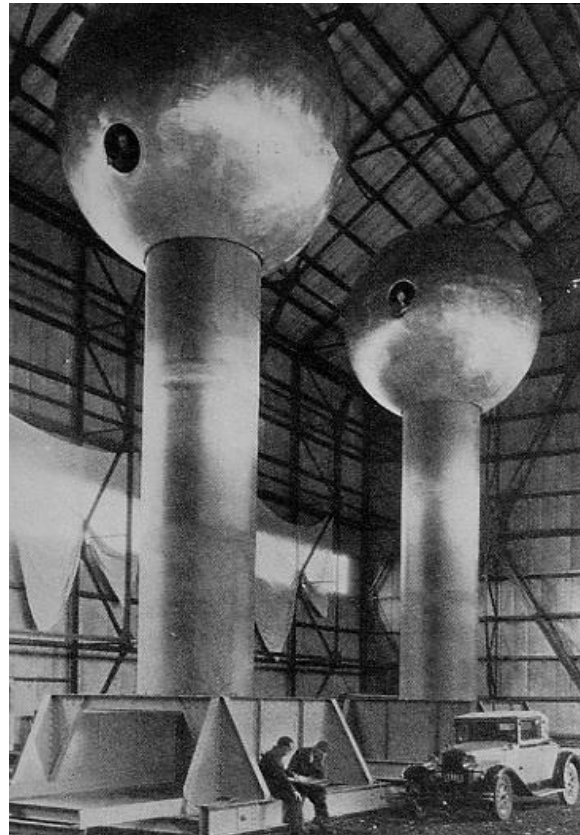
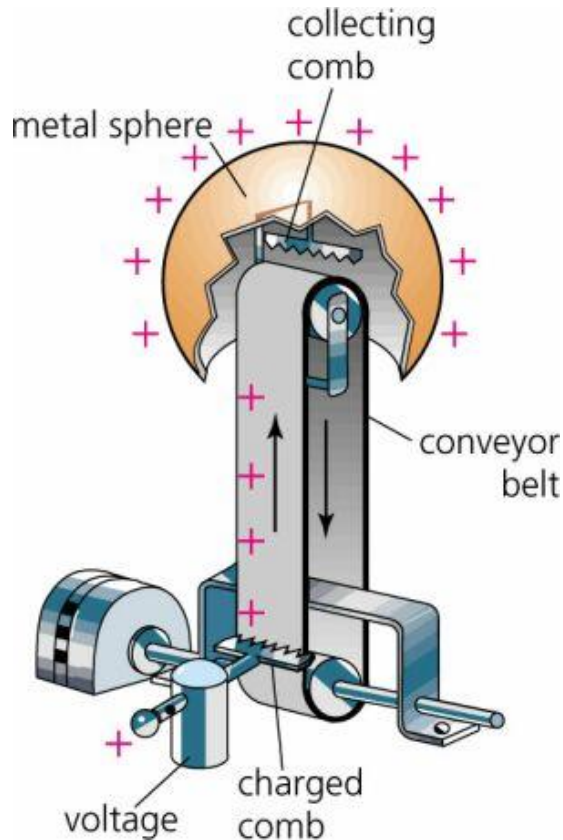

R.J. Van de Graaf

7 MV Van de Graaf at MIT  
(1933)

- Electric charges are transported mechanically on an insulating belt
- Stable, continuous beams, practical limit 10 - 15 MV

## Tandem Van de Graaf

- The DC electric field derives from a potential, therefore the voltage can only be used once for acceleration of a given particle
- The tandem Van de Graaf allows to use the voltage twice, by reverting the charge of the accelerated particle in the center (stripping)

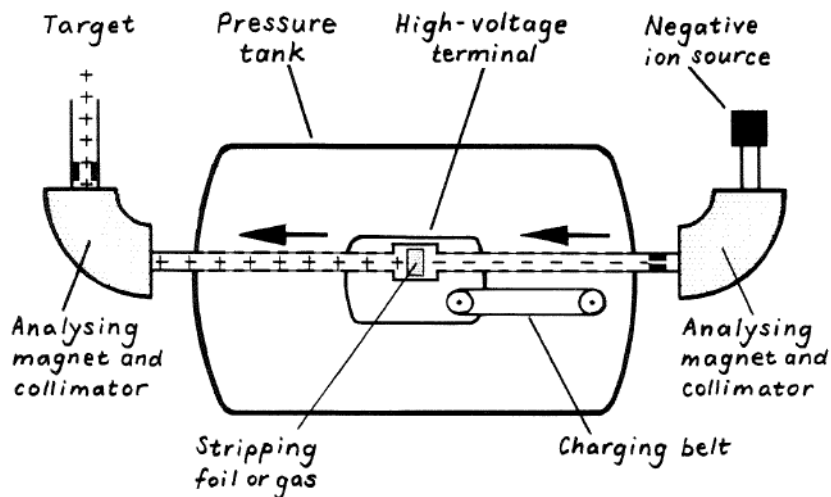

2 x 15 MV tandem Van de Graaf at BNL  
To raise electrical breakdown limits, the machine is contained in a SF<sub>6</sub> tank under pressure



## Widerøe's "ray transformer"

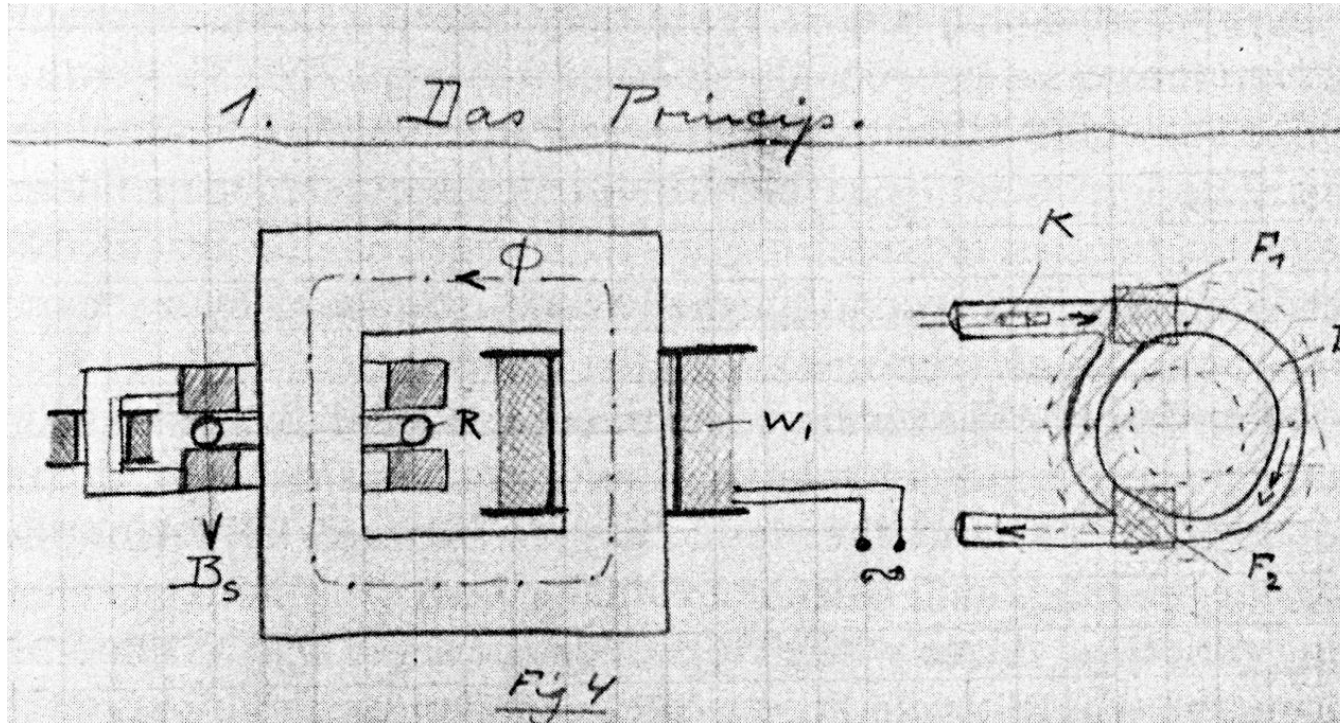

R. Widerøe

- The beam acts as secondary winding of a transformer
- Conceptual design by R. Widerøe, PhD student in 1923
- Unsuccessful attempt to build model machine in 1927
- Reinvented as "betatron" by D. Kerst in 1940

## Kerst's Betatron

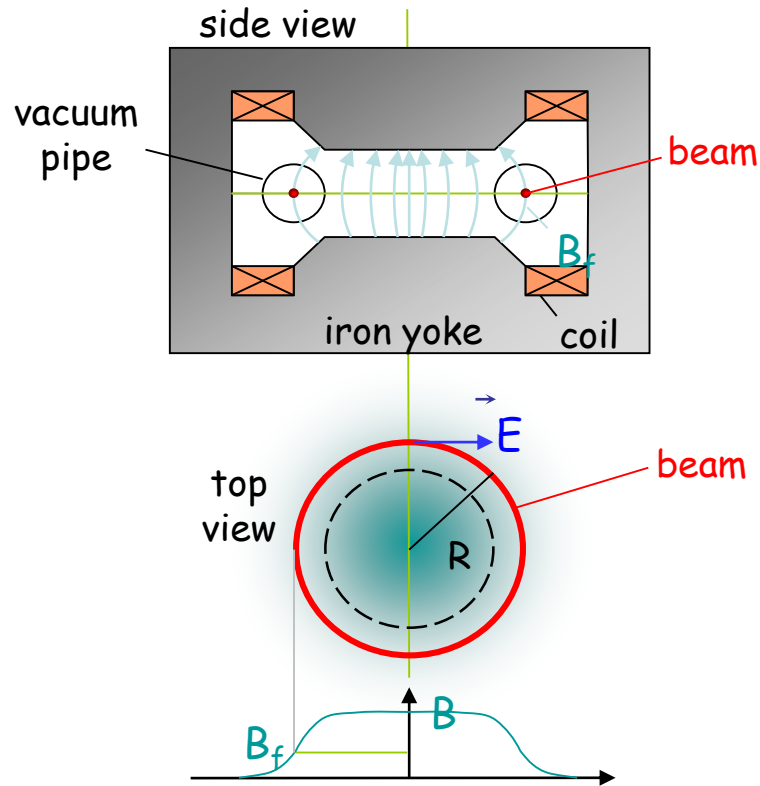

Donald Kerst with the first betatron, built at University of Illinois in 1940

- Compact, robust accelerator insensitive to relativistic effects, well adapted for electrons up to  $\sim 300$  MeV
- Used in industry and medicine



## Ising's RF linear accelerator

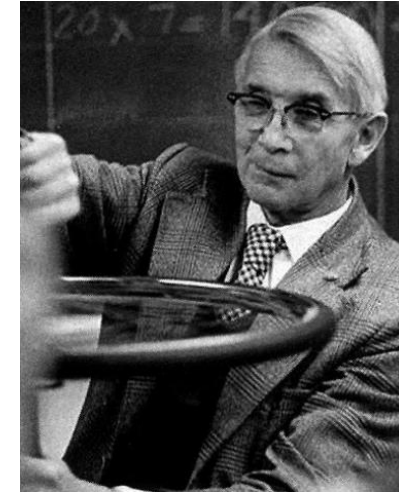
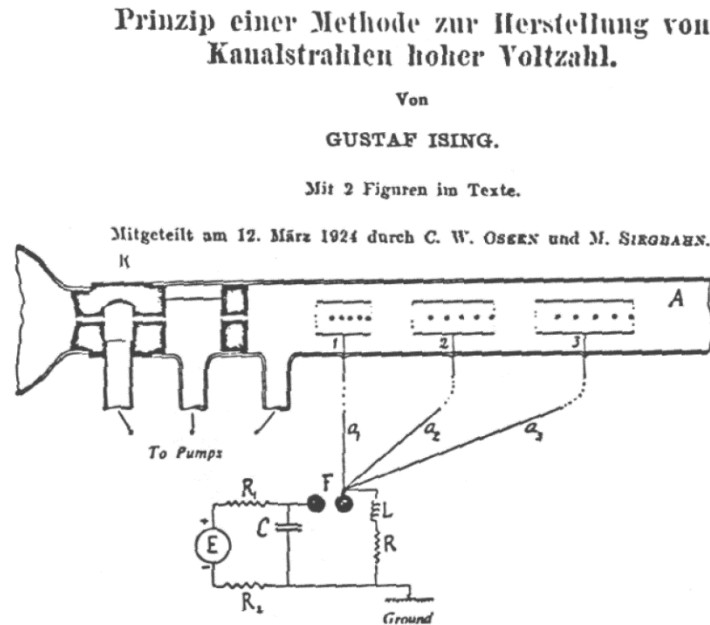

G. Ising

- Electrostatic accelerators are limited in voltage by
  - electrical breakdown  $\Rightarrow$  to go higher, use time-varying fields (RF)
  - flux conservation of electrical field, entailing single-pass acceleration in DC
- In 1924, Ising proposes time-varying fields across drift tubes: the particles can then reach energies above that given by highest voltage in the system
- In 1928, Widerøe builds first demonstration linac using Ising's principle

## Widerøe 1928

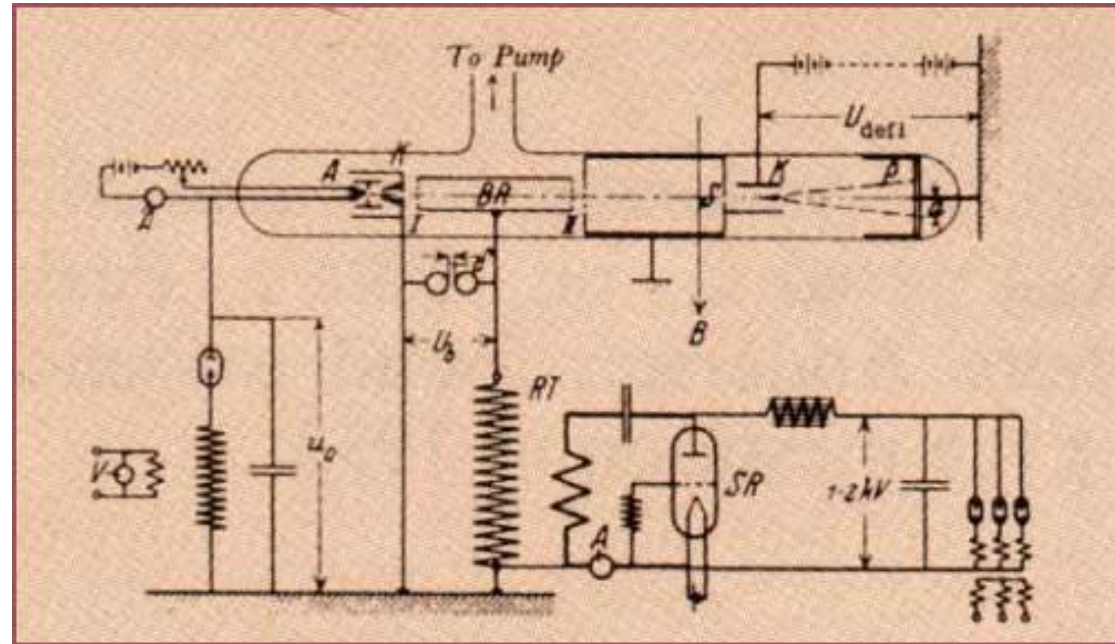

Particles with a positive electric charge are drawn into the first cylindrical electrode by a negative potential; by the time they emerge from the tube the potential has switched to positive, which propels them away from the electrode with a second boost. Adding gaps and electrodes can extend the scheme to higher energies

## Alvarez's proton linac Berkeley 1946



L. Alvarez

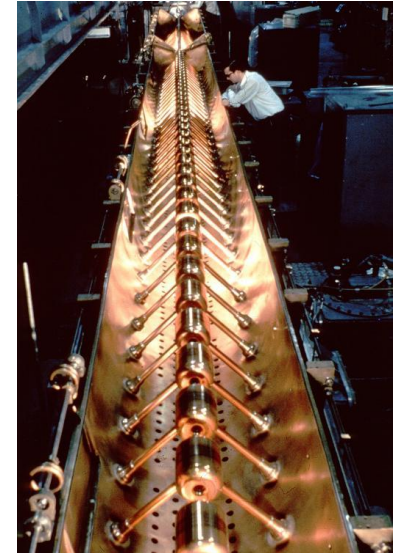
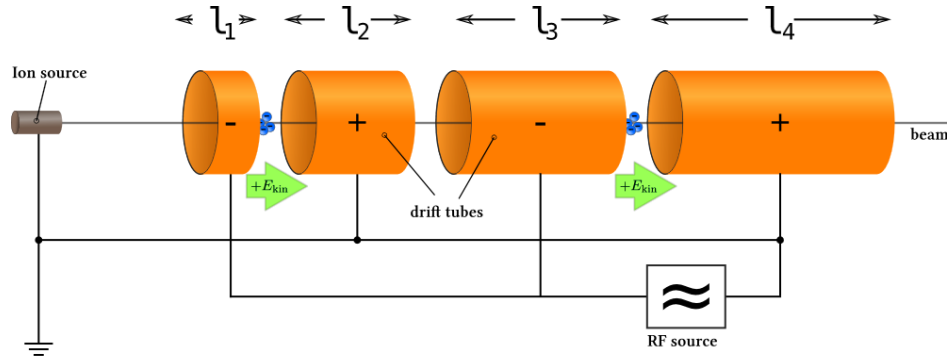

- Synchronism condition

$$L = v \frac{T_{RF}}{2} = \frac{v}{2f_{RF}}$$

- Acceleration occurs in the gaps between the drift tubes
- First practical proton linac (200 MHz, 32 MeV) built by L. Alvarez at Berkeley in 1946
- As particle velocity increases, the drift tubes get longer  $\Rightarrow$  lost length
- This can be contained by increasing  $f_{RF} \Rightarrow$  increased power loss
- To limit power loss, enclose the system into a resonant cavity



# Varian's klystron (1939) and Hansen's electron linacs (1947-1960) Stanford University

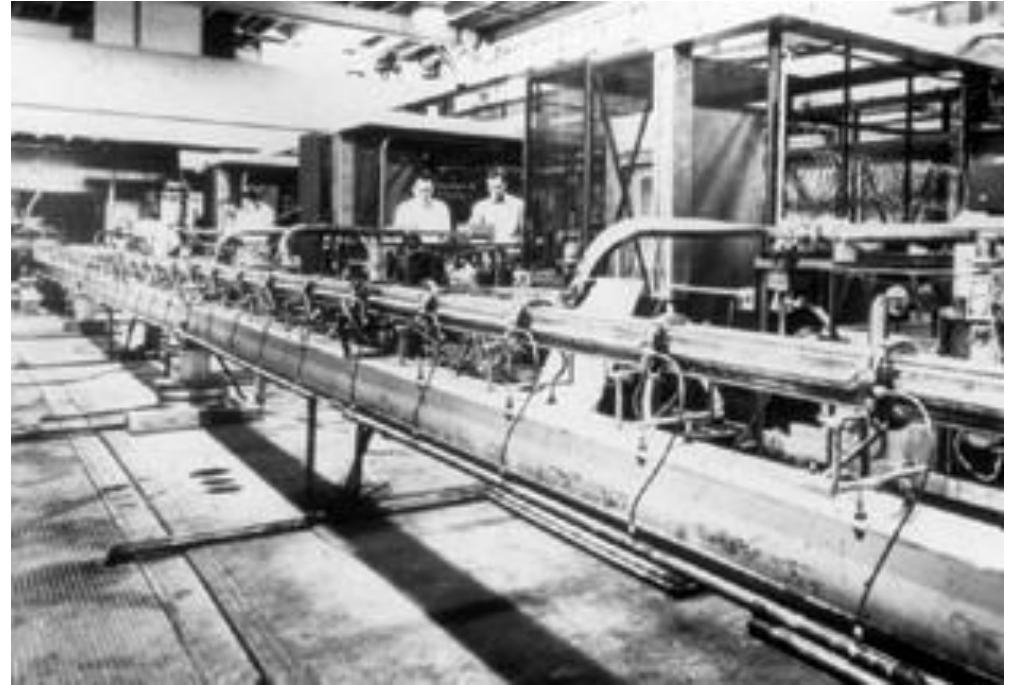
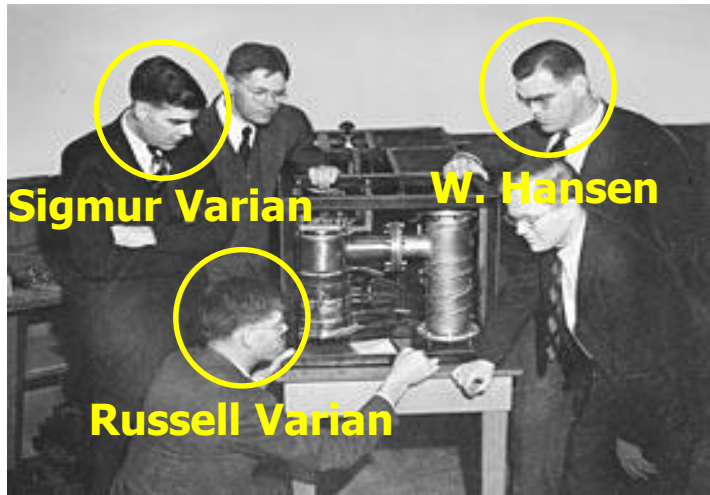

Mark III electron linac (75 MeV)

In the 1950s, Stanford becomes the center for electron linacs, of increasing beam energy



Mark I electron linac (6 MeV)

## R. Hofstadter studies the proton by electron scattering Stanford 1957, Nobel Prize 1961

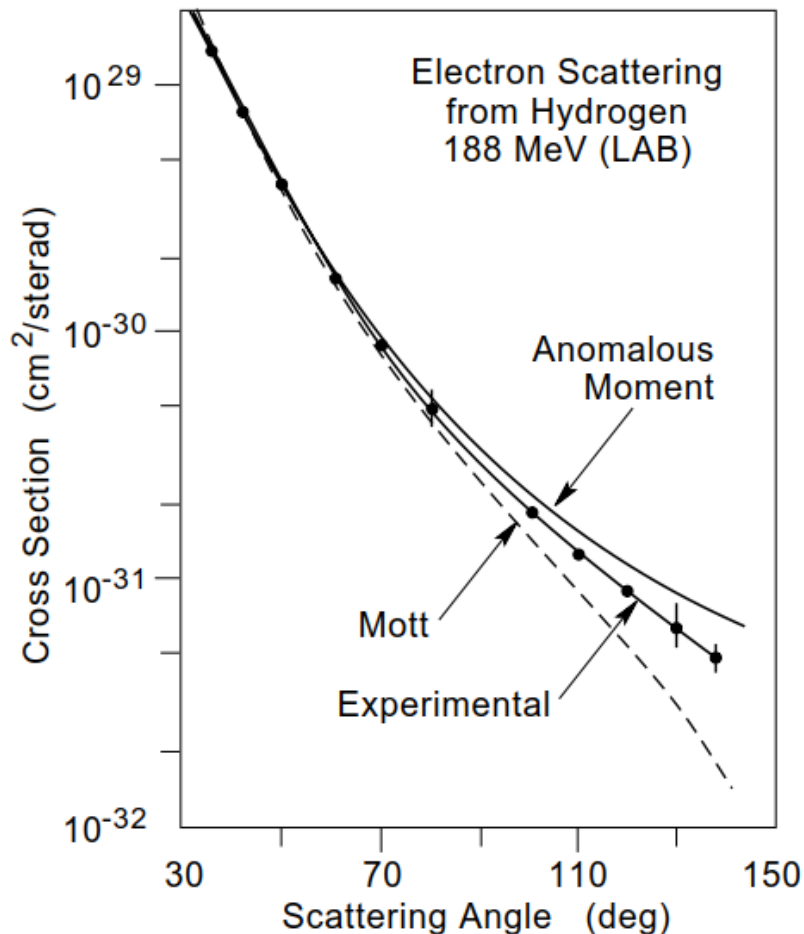

- Similar to Rutherford's scattering experiments half a century earlier, experiments at the Mark III accelerator show an excess of electrons scattered at large angles
- This is a sign of finite size and a hint of some internal structure of the proton
- A 20 GeV electron linear accelerator, 3 km long, was proposed in 1957 to explore further this structure with «harder» probes, and built in the early 1960s: SLAC

## The Stanford Linear Accelerator Center (SLAC)





# J. Friedman, H. Kendall & R. Taylor discover point scatterers inside the proton Stanford 1968, Nobel Prize 1990

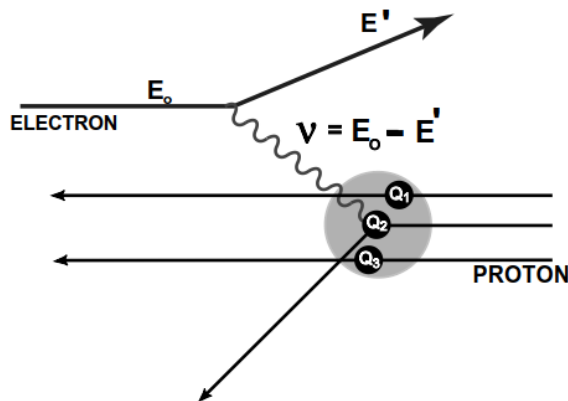
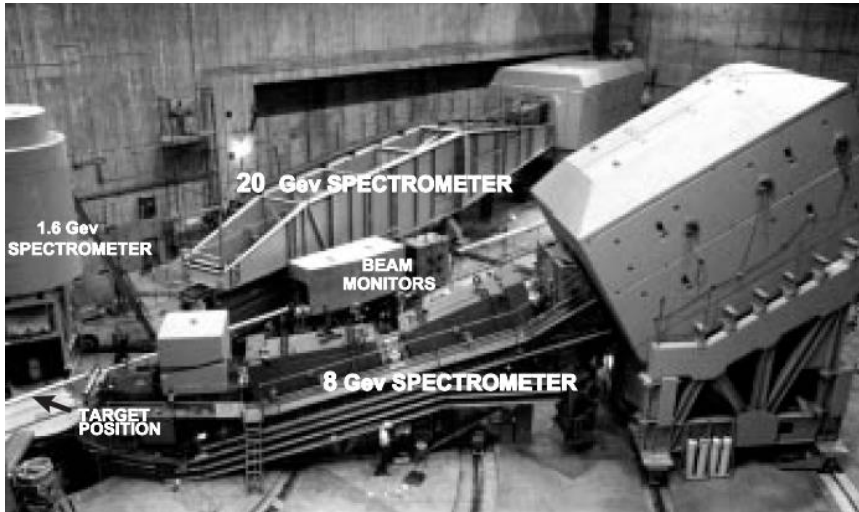

R. Feynman explains the results by point scattering from individual «partons» inside the proton

This later validates the theory of quarks developed by M. Gell-Mann

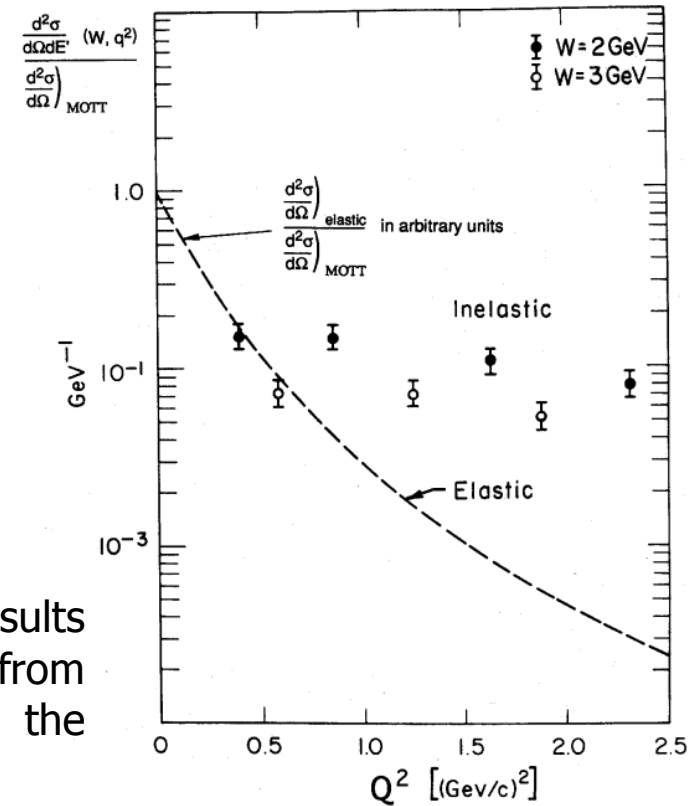

## E.O. Lawrence tries to read Wideroe's paper Berkeley 1930



*Not being able to read German easily, I merely looked at the diagrams and photographs of Wideroe's apparatus... and readily understood his general approach to the problem, i.e. the multiple acceleration of the positive ions by application of radio-frequency oscillating voltages to a series of cylindrical electrodes*

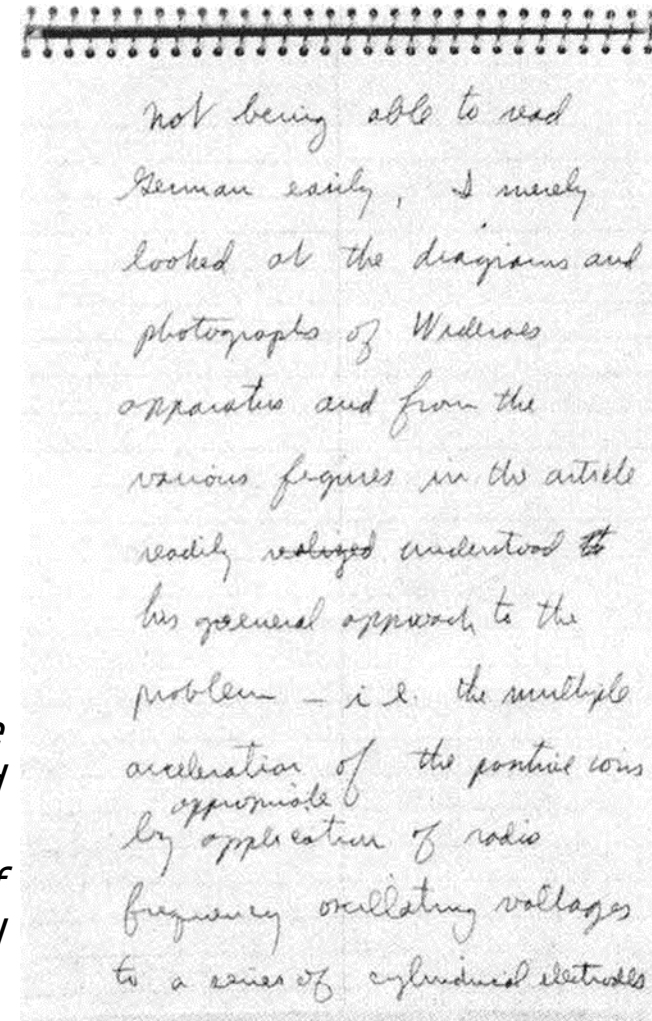

## Lawrence & Livingston's cyclotron Berkeley 1931

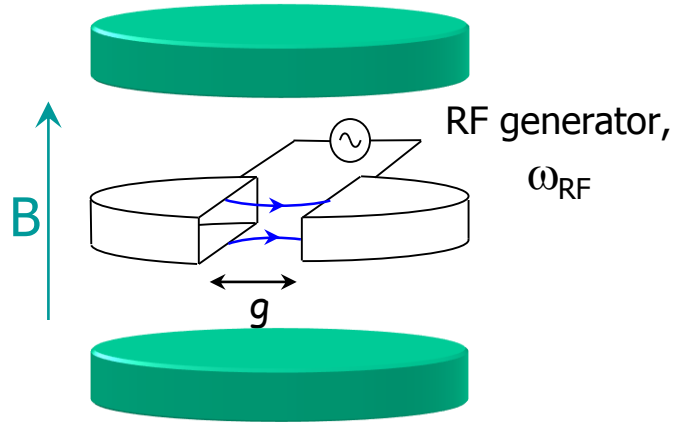

- “Folded-in” linac: the electrodes are the “dees” immersed in magnetic field
- Orbits are spirals as particles gain energy at each gap crossing
- Constant magnetic field means constant frequency at  $\gamma = 1$ , no exact synchronism for relativistic particles

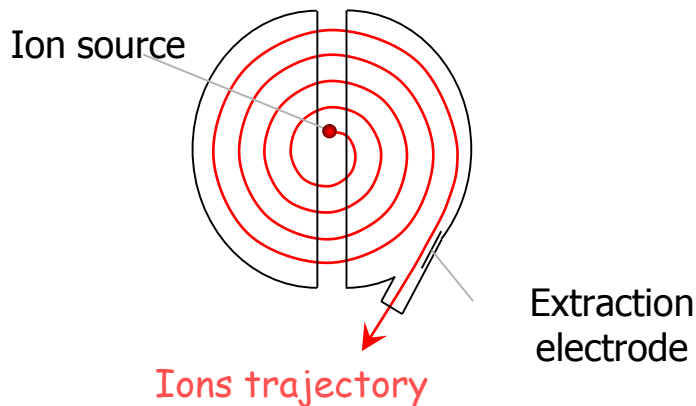

Synchronism  $2\pi\rho = vT_{RF} = v/f_{RF}$

Cyclotron frequency  $\omega_{RF} = \frac{eB}{m_0\gamma}$



## First cyclotrons Berkeley 1931

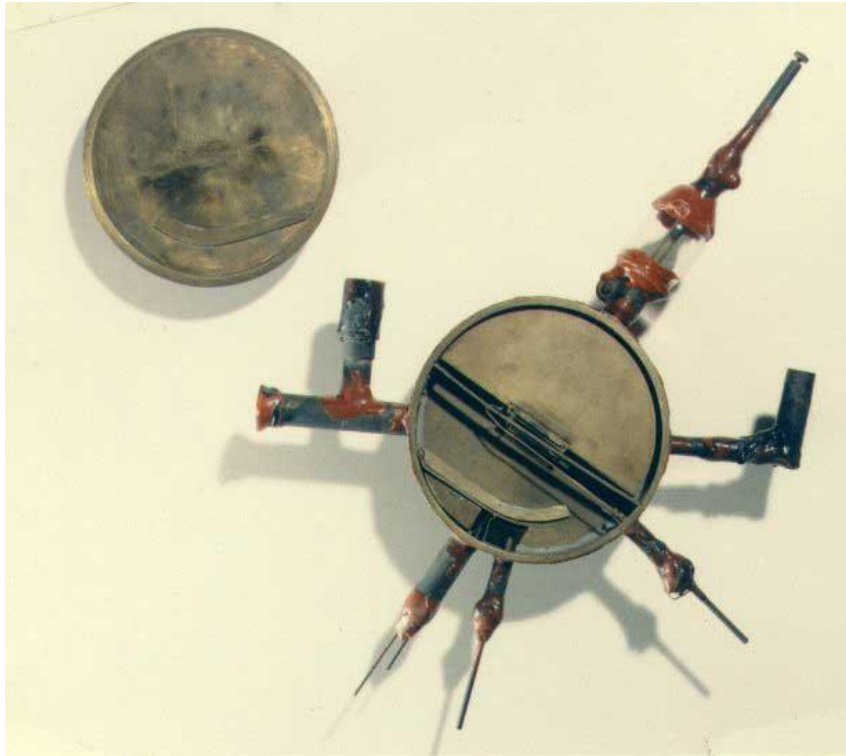

4.5 inch Cyclotron: 1800 V RF  
accelerates to 80 keV (January 1931)

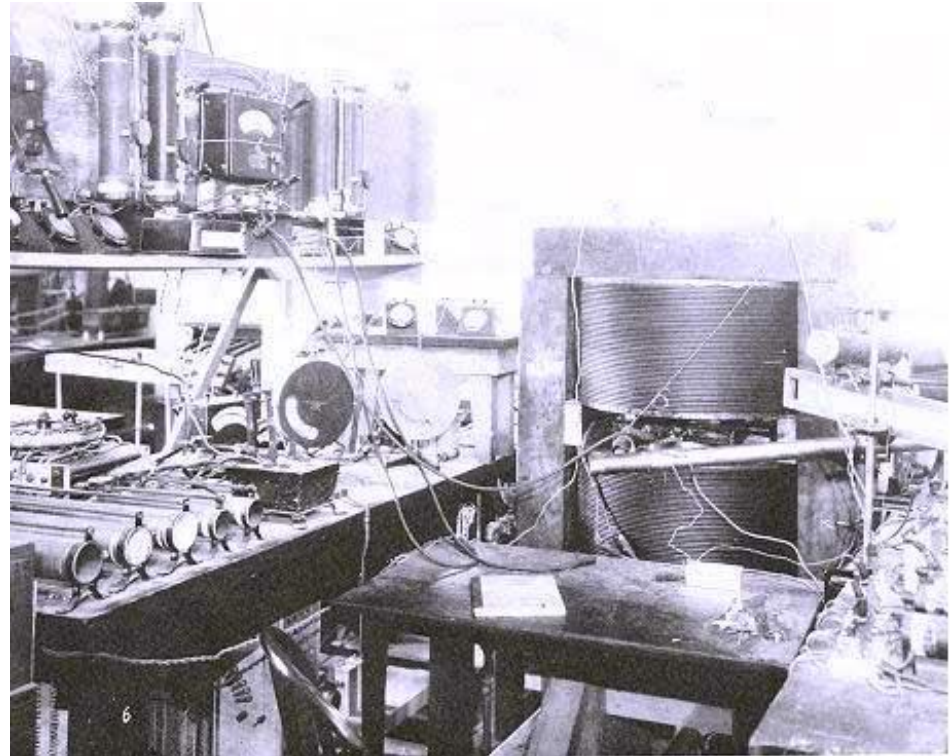

11 inch cyclotron accelerates  
protons to 1 MeV (summer 1931)

## The escalation...

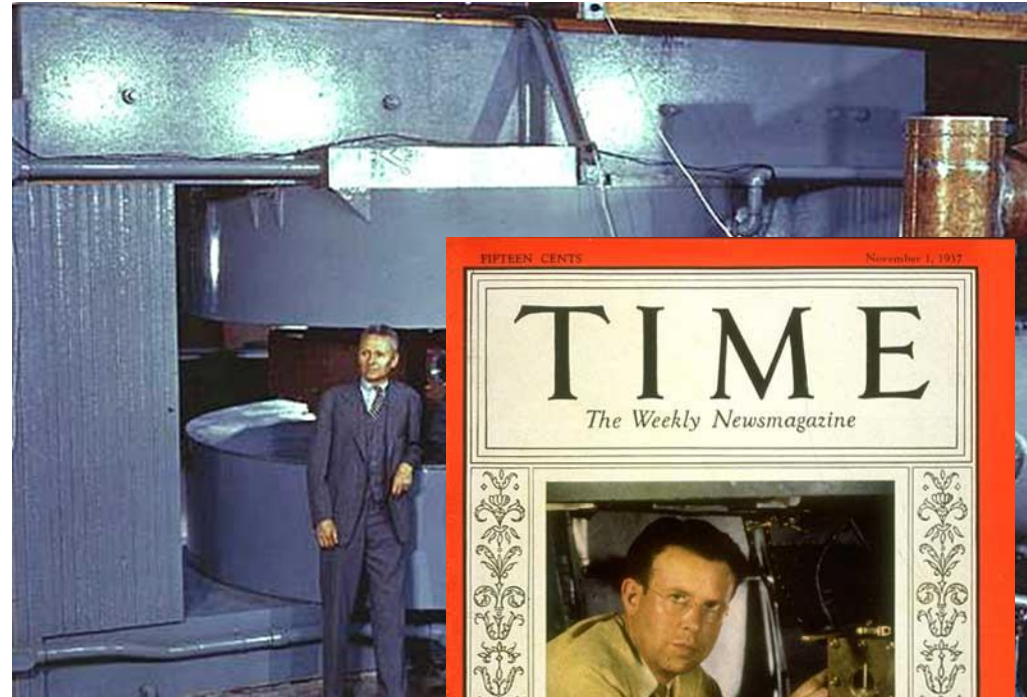
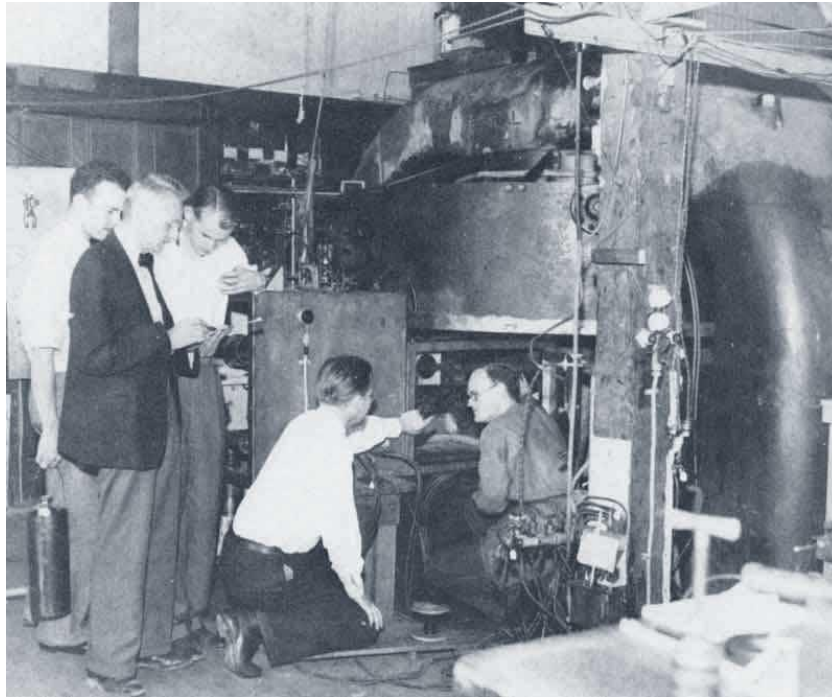

- 27 inch cyclotron, 80 ton magnet, 3.6 MeV (summer 1932)
- 37 inch cyclotron (1937)
- 60 inch cyclotron (1939)

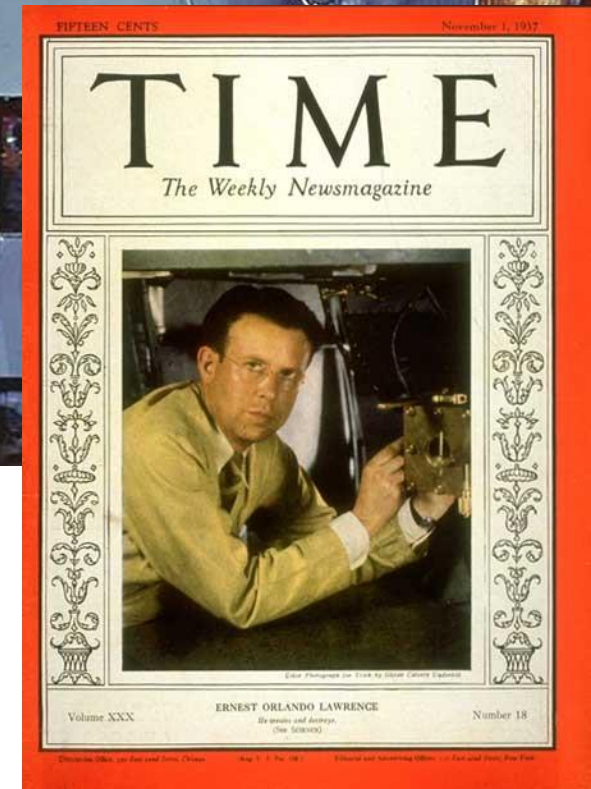



## The escalation (continued...)

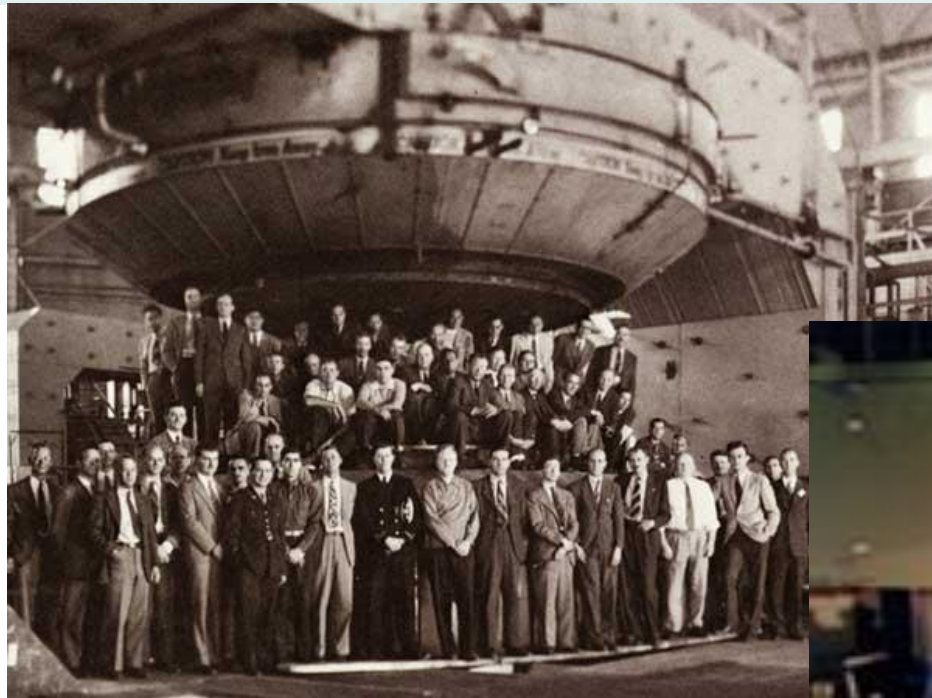

Berkeley 184-inch cyclotron, 4000 ton magnet, >100 MeV protons (1946)

Gatchina cyclotron, 10'000 ton magnet, 1 GeV protons (1957)





## High-energy cyclotrons



TRIUMF 520 MeV proton cyclotron  
(Vancouver, Canada)



Poles of the 600 MeV ion superconducting cyclotron  
(Catania, Italy)

- Cyclotrons face two types of limitation at higher energy
  - Loss of isochronism in the relativistic regime
  - Large size of the magnet
- Possible solutions
  - Synchro-cyclotrons
  - Sectored magnet  $\Rightarrow$  isochronism and focussing
  - Superconducting magnets  $\Rightarrow$  higher field  $\Rightarrow$  higher energy at given radius

## Invention of the synchrotron

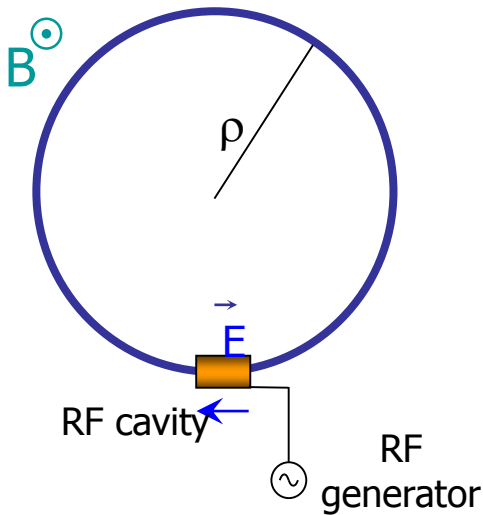

M. Oliphant

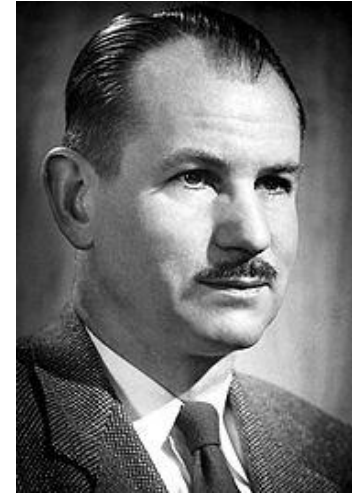

E. McMillan



V. Veksler

- In 1943, M. Oliphant proposed the concept of synchrotron, developed by E. McMillan and V. Veksler who solved the issue of “phase stability” (see later)
  - Constant orbit during acceleration:  $B$  must increase in time
  - Revolution frequency must increase during acceleration (non-relativistic)
- $$\frac{2\pi\rho}{v} = T = \frac{1}{f}$$
- RF frequency is a multiple of revolution frequency  $f_{RF} = hf$

## Bending field vs time in the LHC

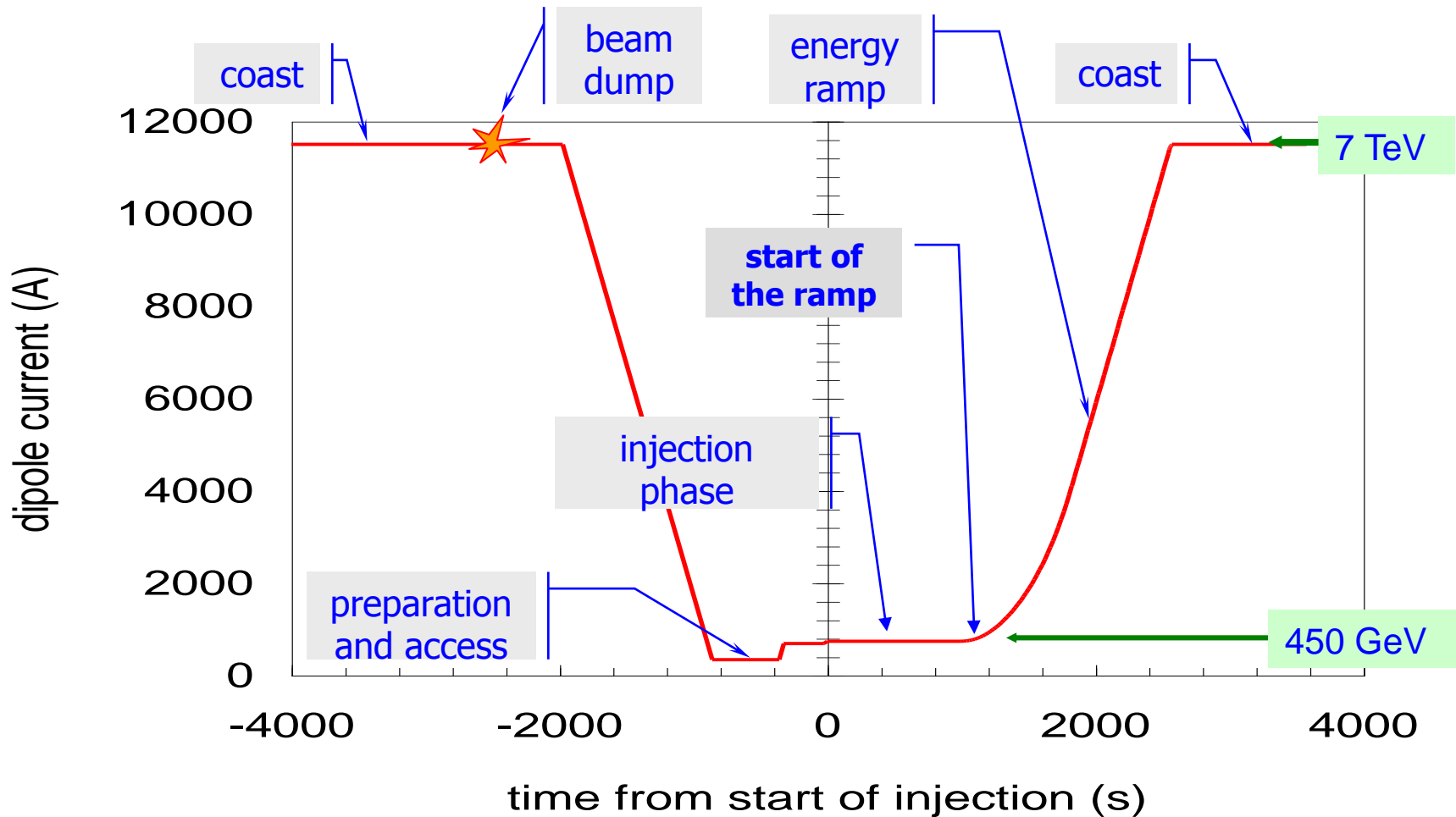



## Notion of phase stability The condition for longitudinal focussing

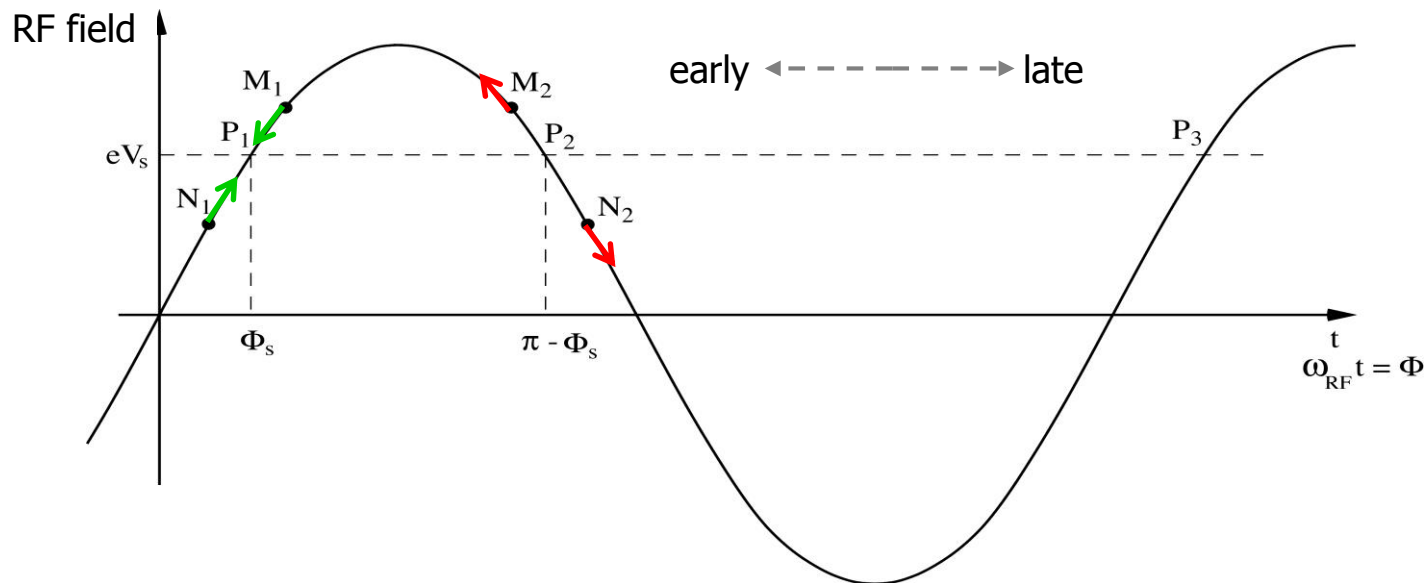

- In a certain energy range, acceleration by RF field results in early arrival of particle at next turn: for stability, this particle should undergo less acceleration
- Operating point P2 is unstable
  - Late particle N2 sees lower acceleration and gets even later
  - Early particle M2 sees higher acceleration and gets even earlier
- Operating point P1 is stable

## The phase stability principle McMillan & Veksler (1945)

- In the phase/momentum plane, the areas of stable motion (closed trajectories) are called "buckets"
- Particles outside the buckets get lost
- As the synchronous phase gets closer to 90 degrees the buckets gets smaller
- The phase extension of the bucket is maximum for a phase of 180 degrees (or 0) which corresponds to no acceleration

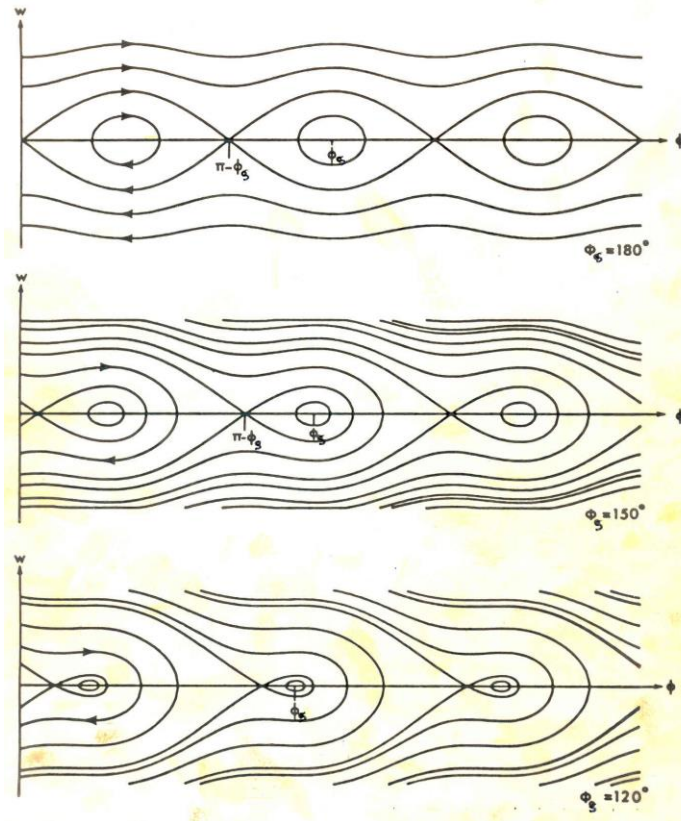

## Notion of transverse focussing

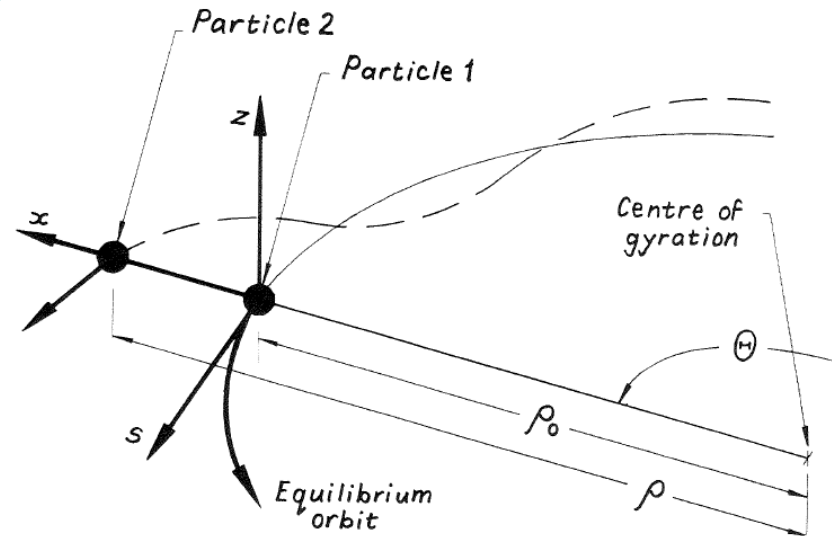

- Consider a particle of momentum  $p$  in a circular accelerator, with a deviation  $x = \rho - \rho_0$  with respect to the equilibrium orbit, of radius  $\rho_0$
- The quantity  $B\rho$  is an invariant  $B\rho = B_0\rho_0 = \frac{p}{e}$
- Some horizontal focussing is provided by the bending field; increasing the field seen by the particle, i.e. introducing a field gradient  $\partial B/\partial x$  provides additional focussing
- The field gradient can be obtained by shaping the pole pieces of the magnets, as well as by the natural divergence of field lines at their edges



## Early synchrotrons

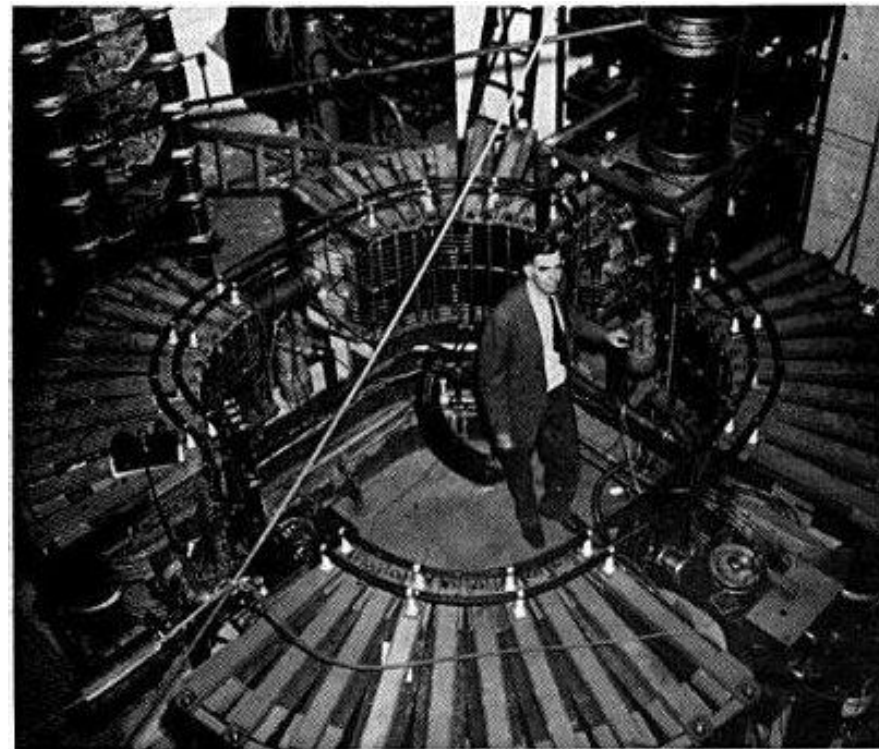

300 MeV electron synchrotron at  
University of Michigan (1949)

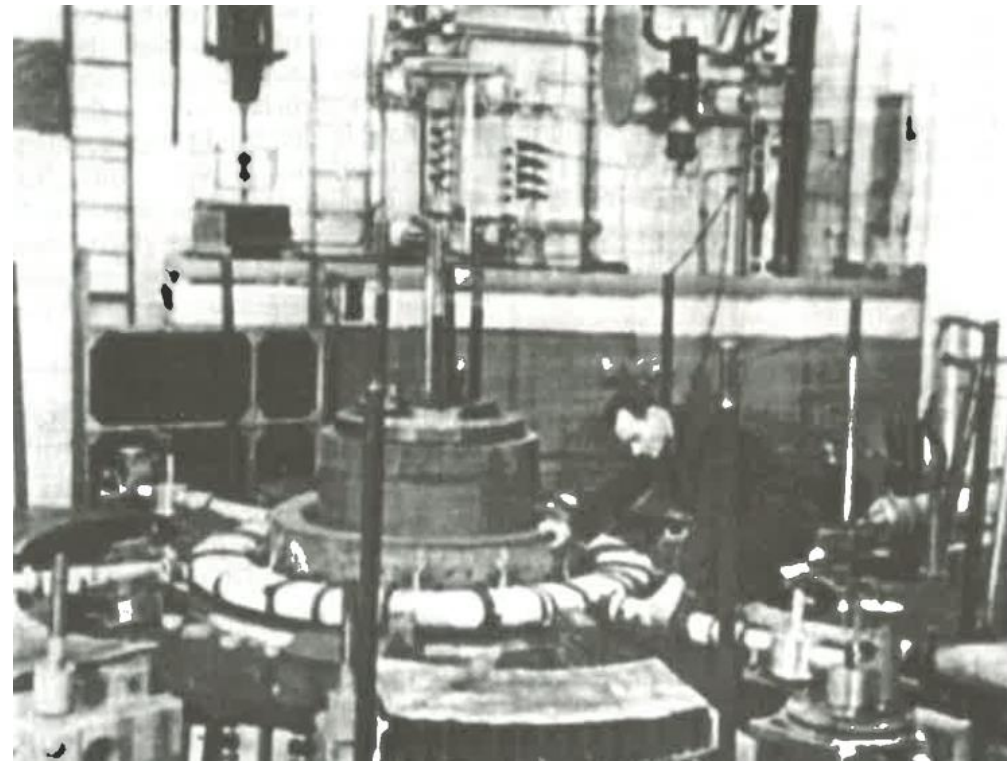

250 MeV electron synchrotron at  
Lebedev Institute, Moscow (1949)

## Discovery of the first antiparticle, the positron Nobel Prize 1936

- The Dirac equation postulates that every particle has its antiparticle
- In 1932, C. D. Anderson discovered the positron (anti-electron) in cosmic rays
- Discovering the antiproton would be a further confirmation of Dirac's postulate



A 63 million volt positron ( $H\rho = 2.1 \times 10^5$  gauss-cm) passing through a 6 mm lead plate and emerging as a 23 million volt positron ( $H\rho = 7.5 \times 10^4$  gauss-cm). The length of this latter path is at least ten times greater than the possible length of a proton path of this curvature.

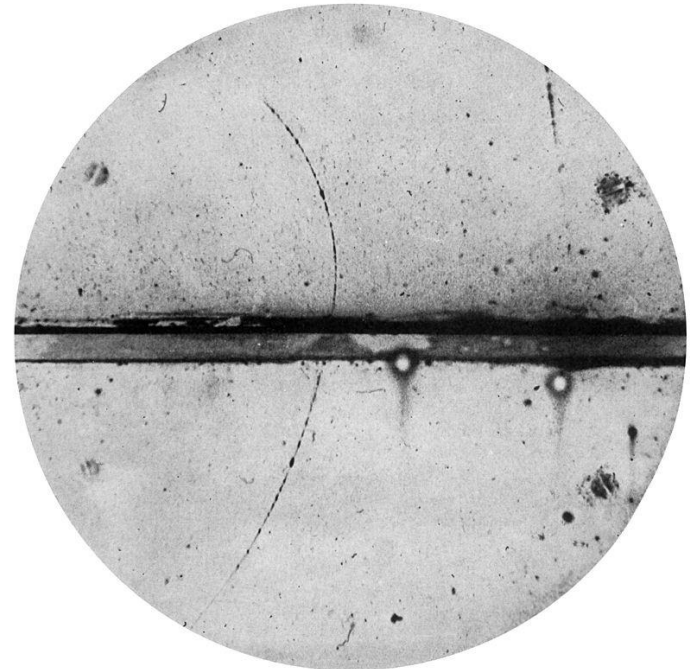

## The BeVatron at Berkeley, a synchrotron tailored to discover the antiproton

- Shooting accelerated protons on a hydrogen target to produce antiprotons  
 $p^+ + p^+ \rightarrow p^+ + p^+ + p^+ + p^-$  (to conserve baryonic number)



- In the laboratory system of reference
  - $p_1$                       momentum of incoming proton
  - $E_1 = mc^2 + K$                       energy of incoming proton
  - $p_2 = 0$                       momentum of target proton
  - $E_2 = mc^2$                       energy of target proton
- Relativistic mass invariant                       $(\sum m)^2 c^4 = (\sum E)^2 - (\sum p)^2 c^2$   
 $16m^2 c^4 = (E_1 + mc^2)^2 - p_1^2 c^2$
- Remembering that                       $m^2 c^4 = E_1^2 - p_1^2 c^2$
- The minimum kinetic energy is                       $K = 6 mc^2 \approx 5.6 \text{ GeV}$



## The 6.2 GeV BeVatron at Berkeley (1954)

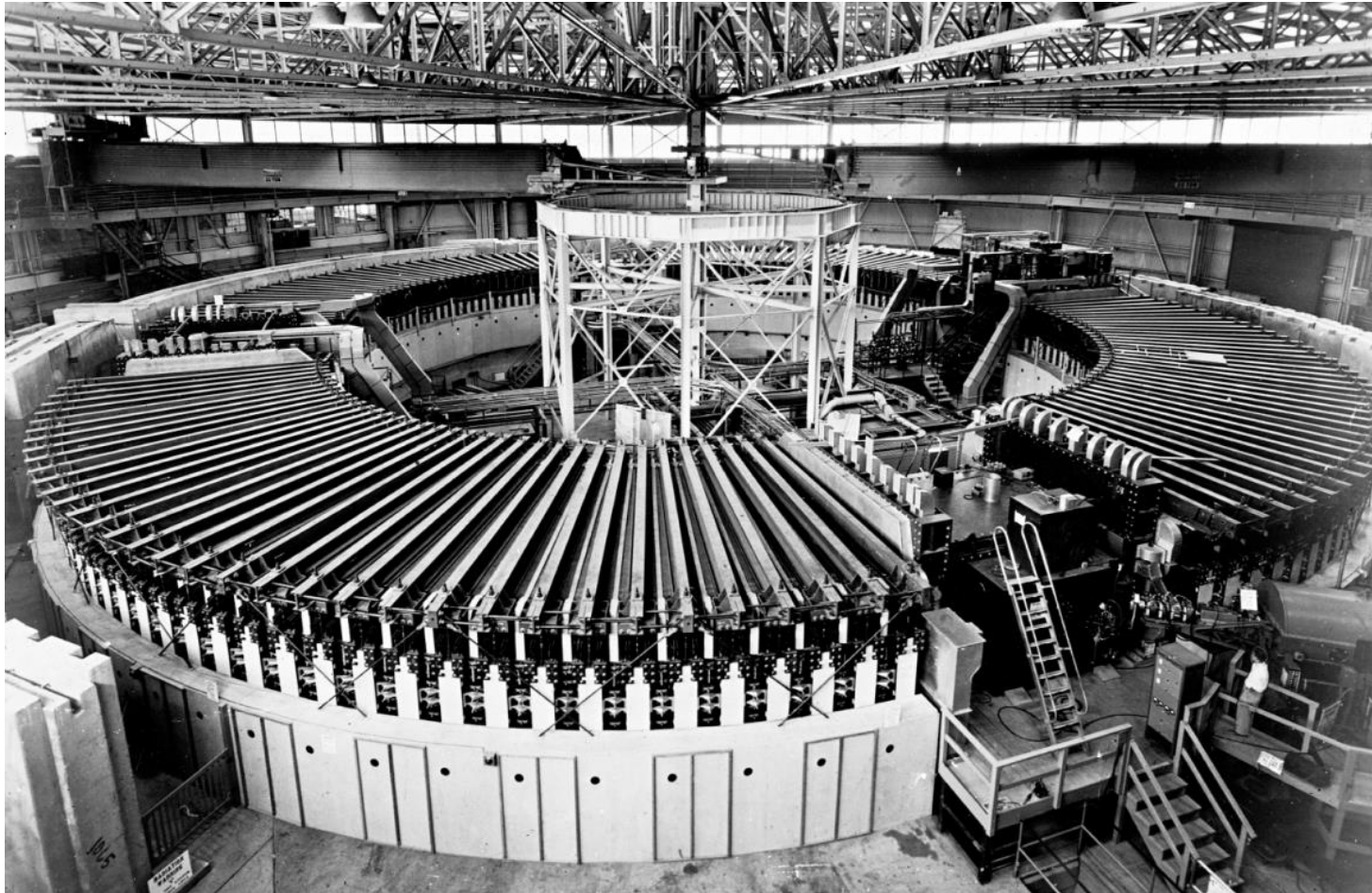

## Discovery of the antiproton (1955) Nobel prize 1959

Principle: determination of mass and charge from measurements of momentum (spectrometer) and velocity (time of flight & Čerenkov)

### Observation of Antiprotons\*

OWEN CHAMBERLAIN, EMILIO SEGRÈ, CLYDE WIEGAND,  
AND THOMAS YPSILANTIS

*Radiation Laboratory, Department of Physics, University of  
California, Berkeley, California*

(Received October 24, 1955)

TABLE I. Characteristics of components of the apparatus.

S1, S2	Plastic scintillator counters 2.25 in. diameter by 0.62 in. thick.
C1	Čerenkov counter of fluorochemical 0-75, (C <sub>8</sub> F <sub>16</sub> O); $\mu_D = 1.276$ ; $\rho = 1.76 \text{ g cm}^{-3}$ . Diameter 3 in.; thickness 2 in.
C2	Čerenkov counter of fused quartz; $\mu_D = 1.458$ ; $\rho = 2.2 \text{ g cm}^{-3}$ . Diameter 2.38 in.; length 2.5 in.
Q1, Q2	Quadrupole focusing magnets: Focal length 119 in.; aperture 4 in.
M1, M2	Deflecting magnets 60 in. long. Aperture 12 in. by 4 in. $B \cong 13\,700$ gauss.

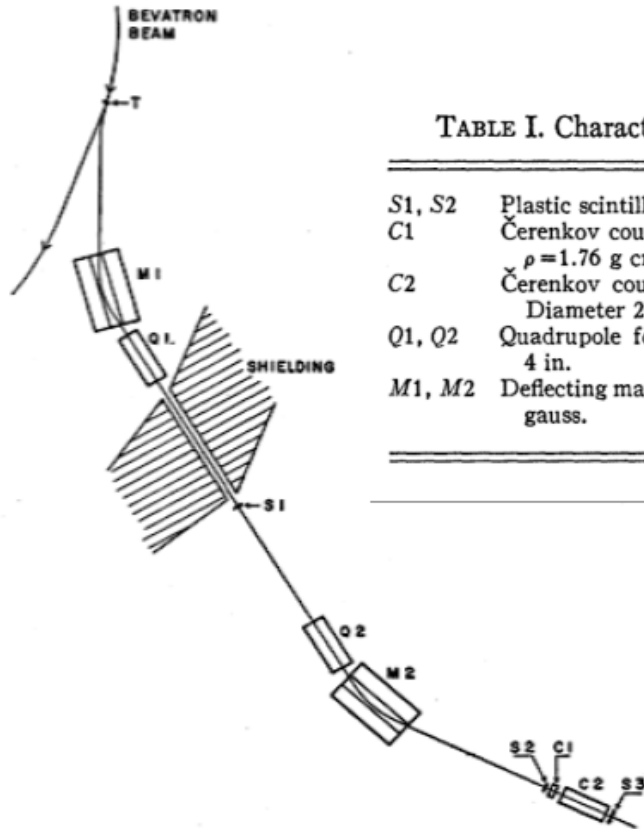

## Strong focussing by alternating gradients

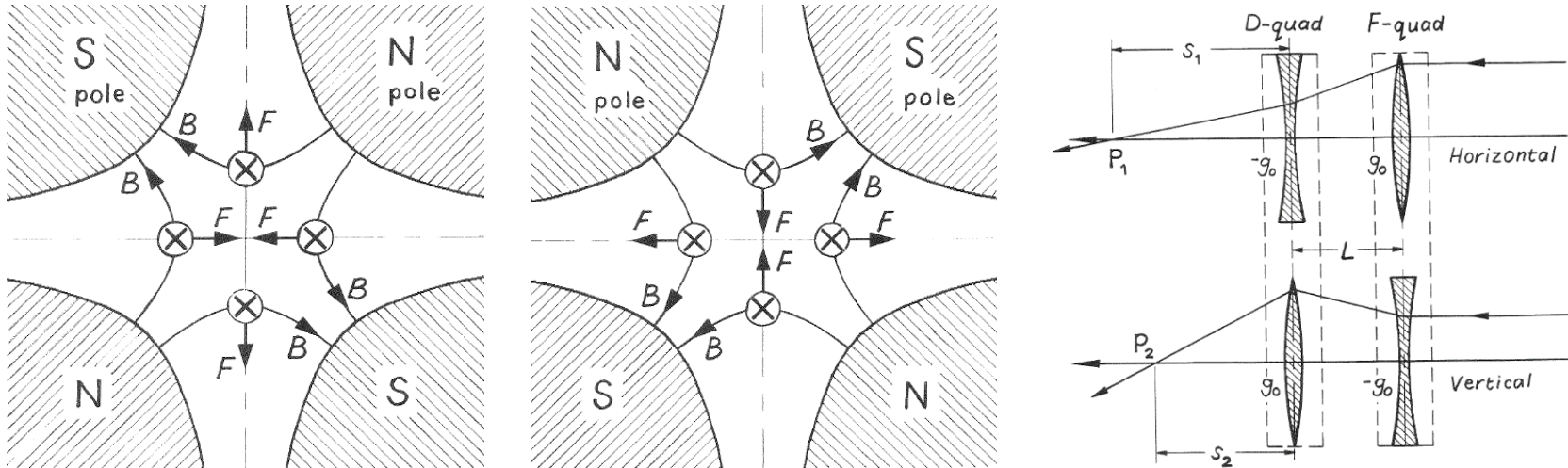

- Increasing the strength of the field gradient can be achieved by using quadrupoles
- However, the magnetic field in the current-free region of the magnet aperture satisfies  $\vec{\nabla} \times \vec{B} = 0$ , implying  $\partial B_z / \partial x = \partial B_x / \partial z$  : focussing in one plane, defocussing in the other
- In 1952, E. Courant and H. Snyder propose alternating-gradient strong focussing: a string of alternately focussing and defocussing quadrupoles of equal or similar gradient is globally focussing
- This scheme had been independently patented by N. Christofilos in 1950



## The inventors of alternating-gradient strong focussing



E. Courant, S. Livingston & H. Snyder

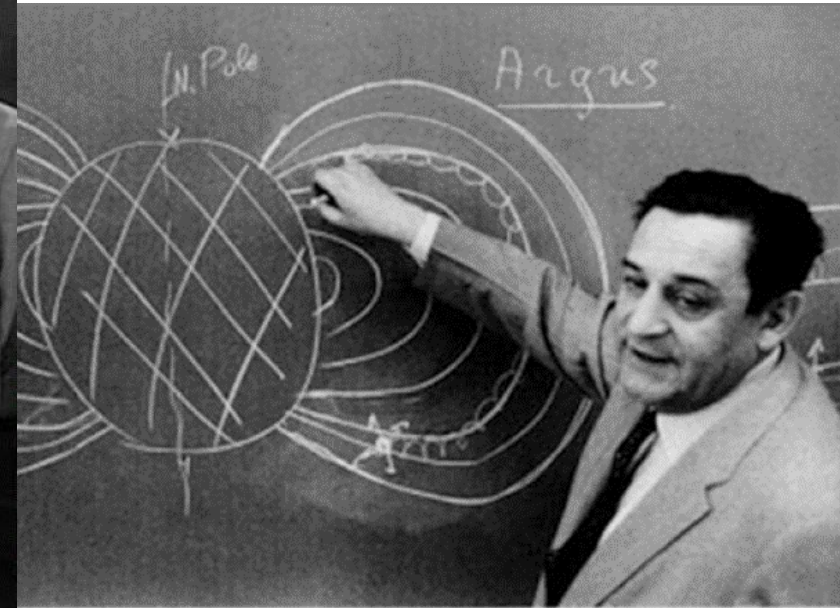

N. Christofilos

- Strong focussing results in smaller beams, hence smaller electro-magnets with lower mass and reduced power consumption

## Combined-function magnets

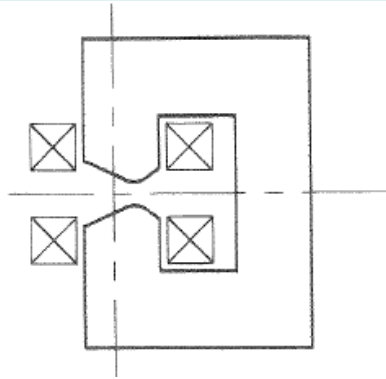

- The gap, and hence the magnetic field, vary across the horizontal aperture
- This superimposes a gradient (quadrupole term) onto the bending (dipole) field

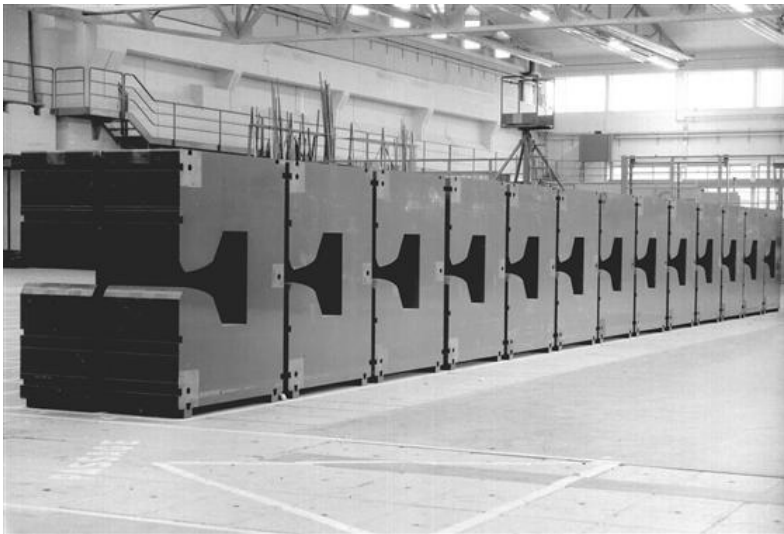

Combined-function yoke blocks for the CERN PS magnets

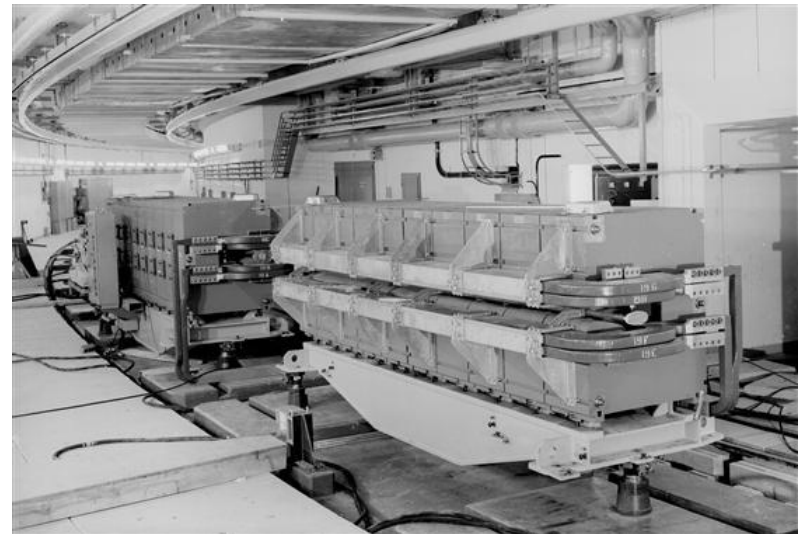

Magnets installed in the PS tunnel, arranged to produce alternating-gradient focussing

## Separated-function magnets

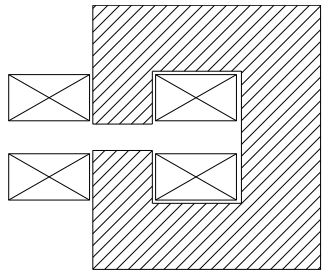

C-shaped

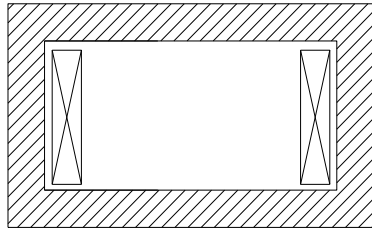

Dipoles  
Window-frame

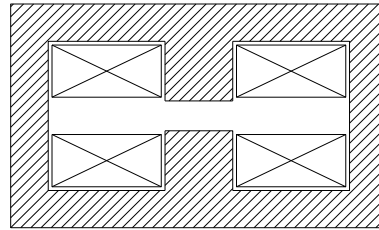

H-type

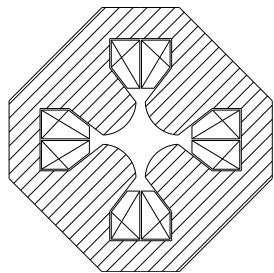

Quadrupoles

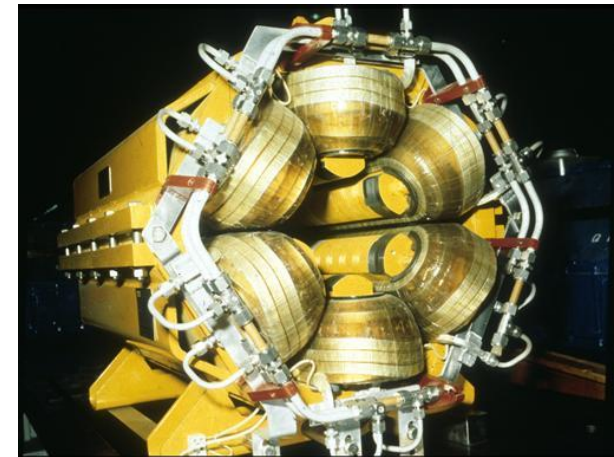
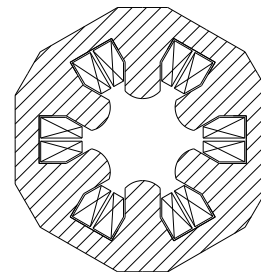

Sextupoles



## Some proton synchrotrons



3 GeV Cosmotron at BNL

weak focussing, combined function magnets

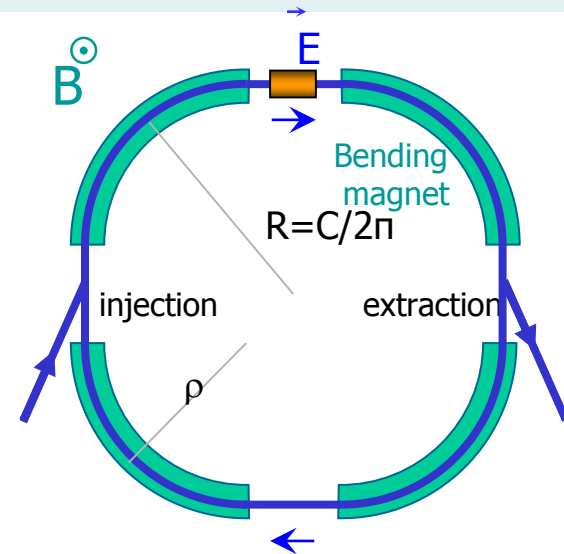

28 GeV PS at CERN

strong focussing, combined function magnets



400 GeV SPS at CERN

strong focussing, separated function magnets

## Fixed-target vs head-on beam collisions

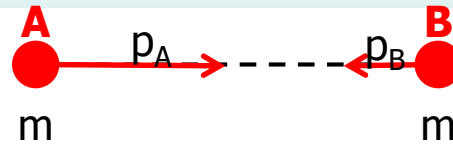

- Relativistic invariant

$$(\Sigma m)^2 c^4 = (\Sigma E)^2 - (\Sigma p)^2 c^2$$

- In the laboratory frame

$$4m^2 c^4 = (E_A + E_B)^2 - (\vec{p}_A + \vec{p}_B)^2 c^2$$

- Let  $E^*$  be the total energy available in the collision

- In the center-of-mass frame

$$\vec{p}^* = \vec{p}_A^* + \vec{p}_B^* \equiv 0$$

$$4m^2 c^4 = E^{*2}$$

$$E^{*2} = (E_A + E_B)^2 - (\vec{p}_A + \vec{p}_B)^2 c^2$$

- Fixed-target

$$p_B = 0 ; E_B = mc^2$$

$$E^{*2} = E_A^2 - p_A^2 c^2 + m^2 c^4 + 2E_A mc^2$$

$$E^{*2} = 2m^2 c^4 + 2E_A mc^2 \approx 2E_A mc^2$$

$$E^* \approx \sqrt{2E_A mc^2}$$

$$E^* = E_A + E_B$$

- Head-on collision

## Fixed-target vs head-on beam collisions

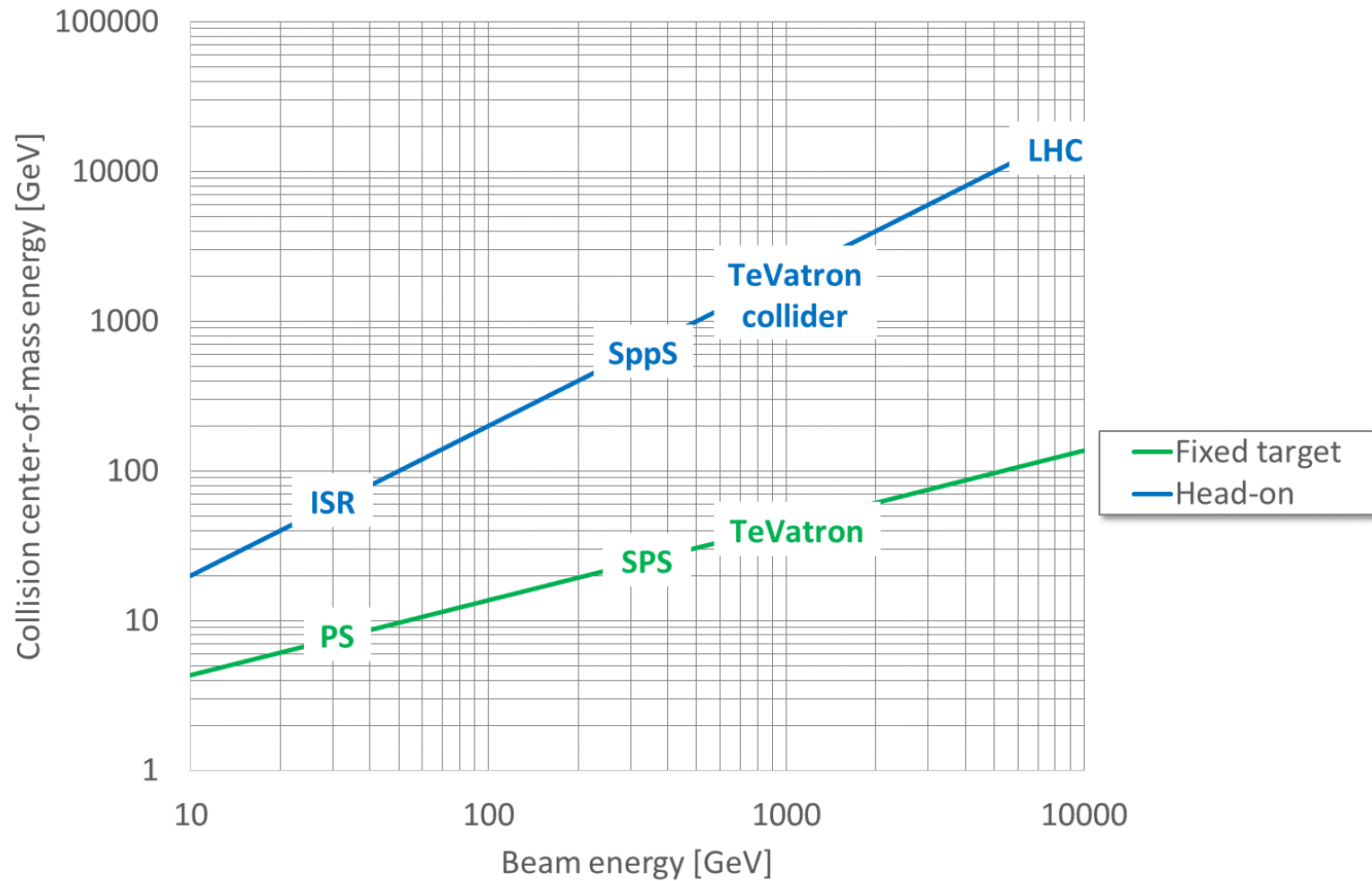



## Luminosity

- The performance of a collider is characterized not only by the collision energy, but also by the luminosity, which is a measure of the event rate
- For colliding beams, the luminosity is defined as the ratio of the event rate  $\dot{N}$  for a given interaction to the cross-section  $\Sigma$  of that interaction

$$\mathcal{L} = \frac{\dot{N}}{\Sigma} \text{ expressed in cm}^{-2} \cdot \text{s}^{-1}$$

- For head-on collisions of bunches of  $N$  particles at frequency  $f_{col}$

$$\mathcal{L} = \frac{N^2 f_{col}}{4\pi\sigma_x\sigma_y} = \frac{N^2 n f_{rev}}{4\pi\sigma_x\sigma_y}$$

with:  $f_{col} = n f_{rev}$ ,  $n$  number of bunches  
 $\sigma_x$  and  $\sigma_y$  measure of beam size at collision

## Towards higher luminosity

- For round beams, introducing emittance  $\epsilon$  and beta function  $\beta^*$  at collision

$$\mathcal{L} = \frac{N^2 n f_{rev}}{4\pi\epsilon\beta^*}$$

⇒ For higher luminosity

- increase bunch population
- reduce emittance
- increase collision frequency ⇒ number of bunches
- reduce  $\beta^*$  ⇒ “low-beta” insertions

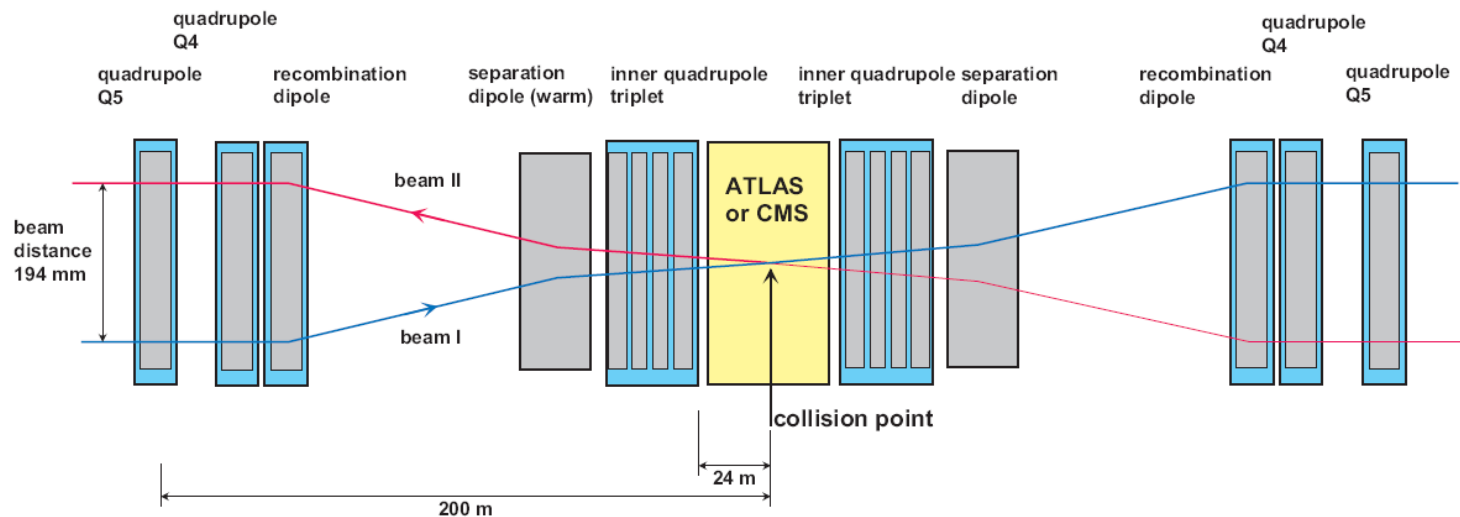

## Particle colliders [1/2]



AdA at Frascati



ISR at CERN



TeVatron at Fermilab

- 1943, R. Widerøe patents the concept of colliding beams in storage rings
- 1961, the first electron-positron storage ring AdA is built in Frascati
- 1971, CERN starts operating the ISR, first proton-proton collider
- 1982, the CERN SPS is converted into a proton-antiproton collider
- 1987, the Tevatron at Fermilab is converted into a proton-antiproton collider
- 1987, the SSC, a 40 TeV proton-proton collider, is approved for construction in the USA. The project was subsequently cancelled in 1993.



# The Intersecting Storage Rings at CERN, the first proton collider

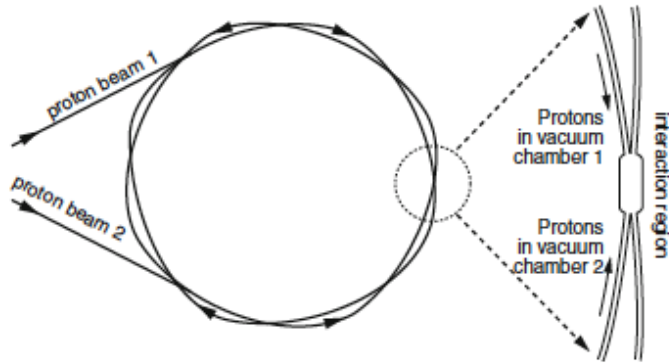

**K. Johnsen**

- Colliding 28 GeV protons fed to two rings from the CERN PS
- First collisions January 1971

## Quasi-elastic scattering at the ISR reveals rising proton cross-section CERN-Pisa-Rome-Stony Brook collaboration 1976

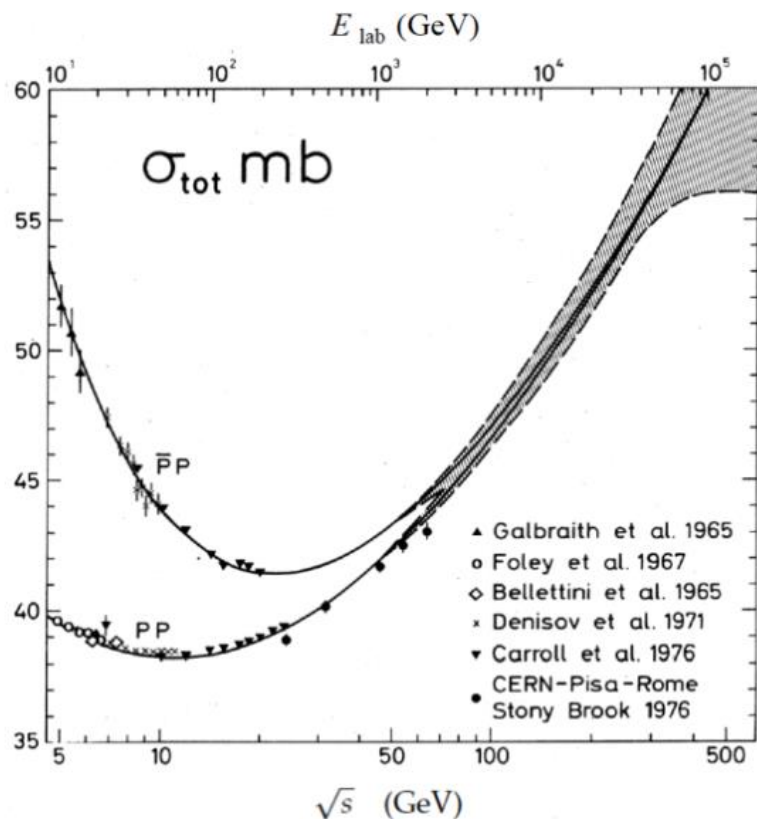

- Scattering at small angles could be measured by bringing removable detectors very close to the colliding beams, in «Roman Pots»



## The PETRA electron-positron collider DESY Hamburg (1978-1986)



B. Wiik



Colliding beams of electrons and  
positrons accelerated at 19 GeV



# Discovery of gluons, mediators of strong interaction TASSO detector at PETRA (1979)

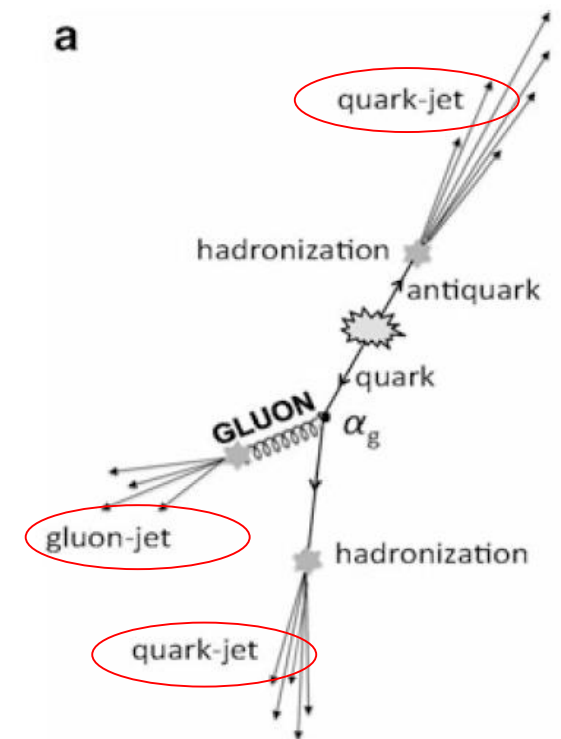
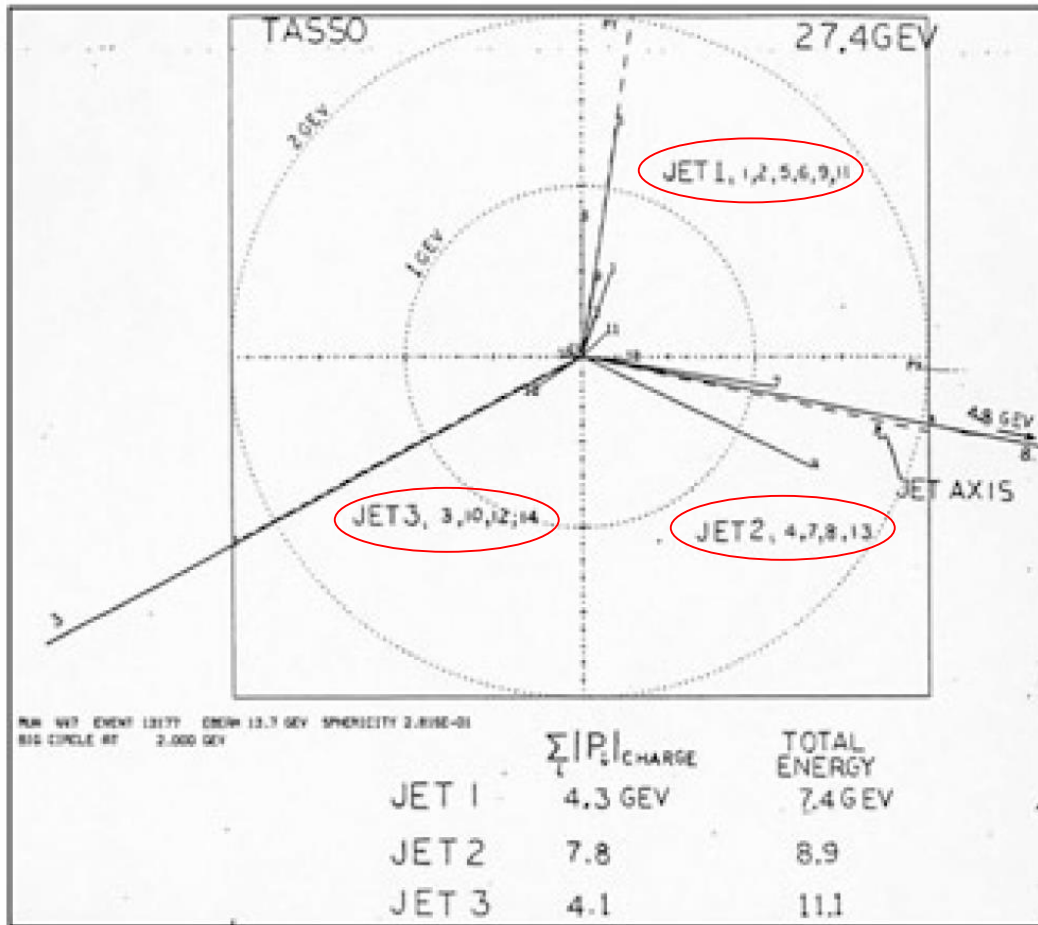

## C. Rubbia searches for the weak vector bosons, proposes to convert the CERN SPS into a p-pbar collider (1978)

- The short range of the weak interaction imposes large masses for the weak vector bosons  $W^+$ ,  $W^-$  and  $Z$ , previously estimated at 60 to 80 GeV for the  $W$ , and 75 to 92 GeV for the  $Z$
- The ideal machine to produce  $W$  and  $Z$  bosons would have been an electron-positron collider of sufficient c.o.m energy, unavailable in the late 1970s
- They could also be produced at a p-p or p-pbar collider

The production of  $W$  and  $Z$  bosons at a  $\bar{p}p$  collider is expected to occur mainly as the results of quark-antiquark annihilation  $\bar{d}u \rightarrow W^+$ ,  $d\bar{u} \rightarrow W^-$ ,  $u\bar{u} \rightarrow Z$ ,  $d\bar{d} \rightarrow Z$ . In the parton model  $\sim 50\%$  of the momentum of a high-energy proton is carried, on average, by three valence quarks, and the remainder by gluons. Hence a valence quark carries about  $1/6$  of the proton momentum. As a consequence,  $W$  and  $Z$  production should require a  $\bar{p}p$  collider with a total centre-of-mass energy equal to about six times the boson masses, or 500–600 GeV. The need to detect  $Z \rightarrow e^+e^-$  decays determines the minimal collider luminosity: the cross-section for inclusive  $Z$  production at  $\sim 600$  GeV is  $\sim 1.6$  nb, and the fraction of  $Z \rightarrow e^+e^-$  decays is  $\sim 3\%$ , hence a luminosity  $L = 2.5 \times 10^{29} \text{ cm}^{-2}\text{s}^{-1}$  would give an event rate of  $\sim 1$  per day. To achieve such luminosities one would need an antiproton source capable of delivering daily  $\sim 3 \times 10^{10}$   $\bar{p}$  distributed in few (3–6) tightly collimated bunches within the angular and momentum acceptance of the CERN SPS.

## Producing antiproton beams meeting the SPS acceptance requires accumulation and «stochastic cooling»



S. Van der Meer

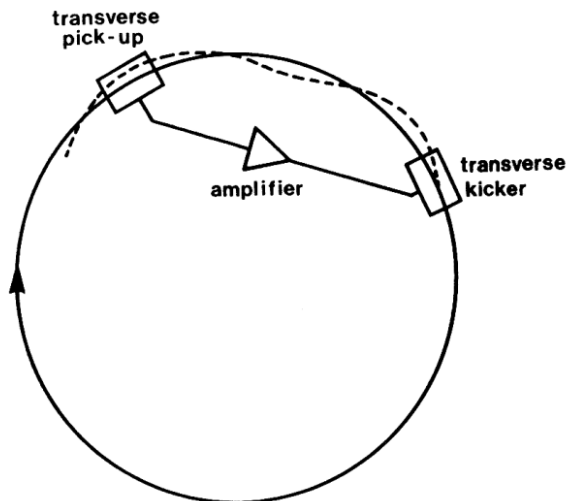

S. Van der Meer invented stochastic cooling of particle beams at the ISR in 1972, and applied it in the Antiproton Accumulator in the early 1980s. The picture shows the RF lines «cutting across» the ring to bring the correction signal from the pick-ups to the kickers



## Discovery of the W bosons (1982) Track reconstruction at UA1 detector

- Identifications by leptonic decays
- Characteristic signal
  - High transverse-momentum electron
  - High missing transverse momentum from the (undetected) neutrino

$$W^{\pm} \rightarrow e^{\pm} \nu_e (\bar{\nu}_e)$$

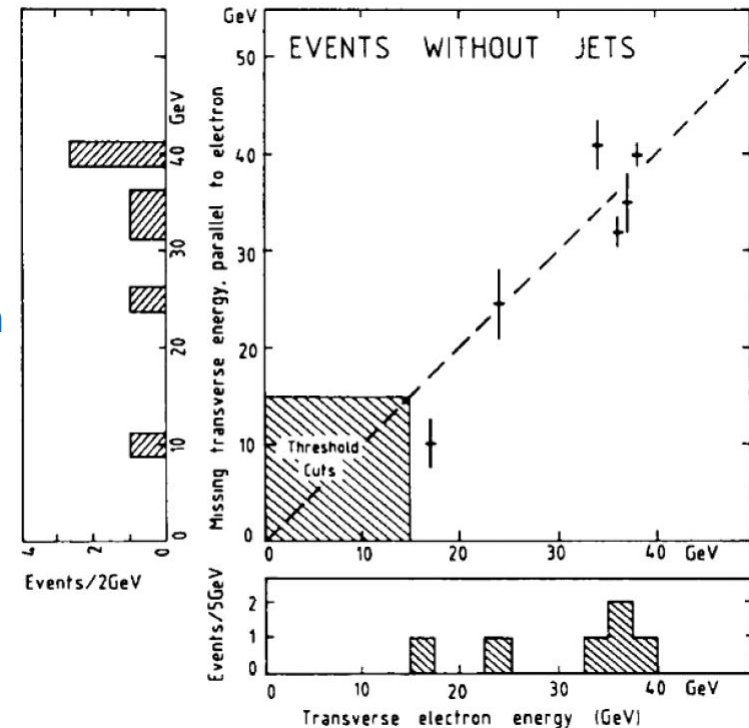
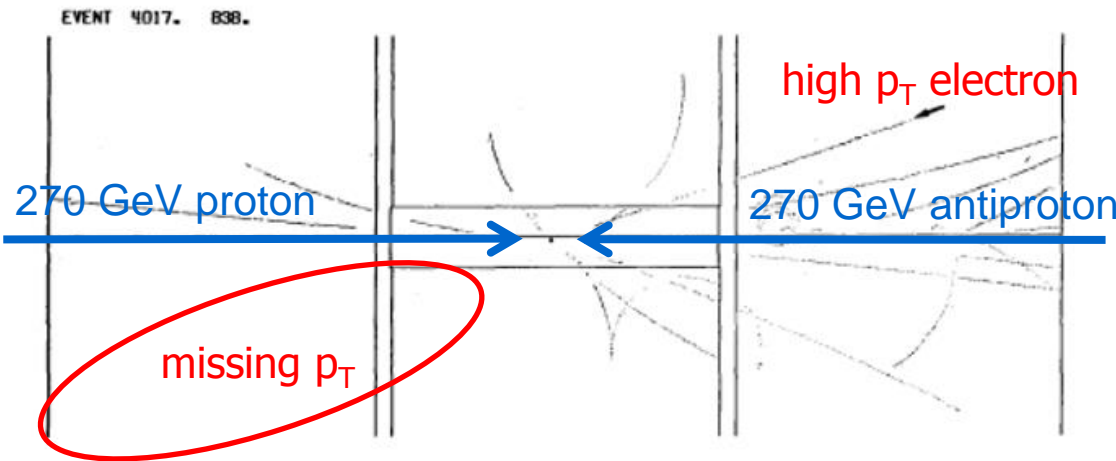

## Discovery of the Z boson (1982) Track reconstruction at UA1 detector

- Identification by leptonic decays
- Characteristic signal
  - Pair of electron and positron with high transverse momentum

$$Z \rightarrow e^+e^-$$

$$Z \rightarrow \mu^+\mu^-$$

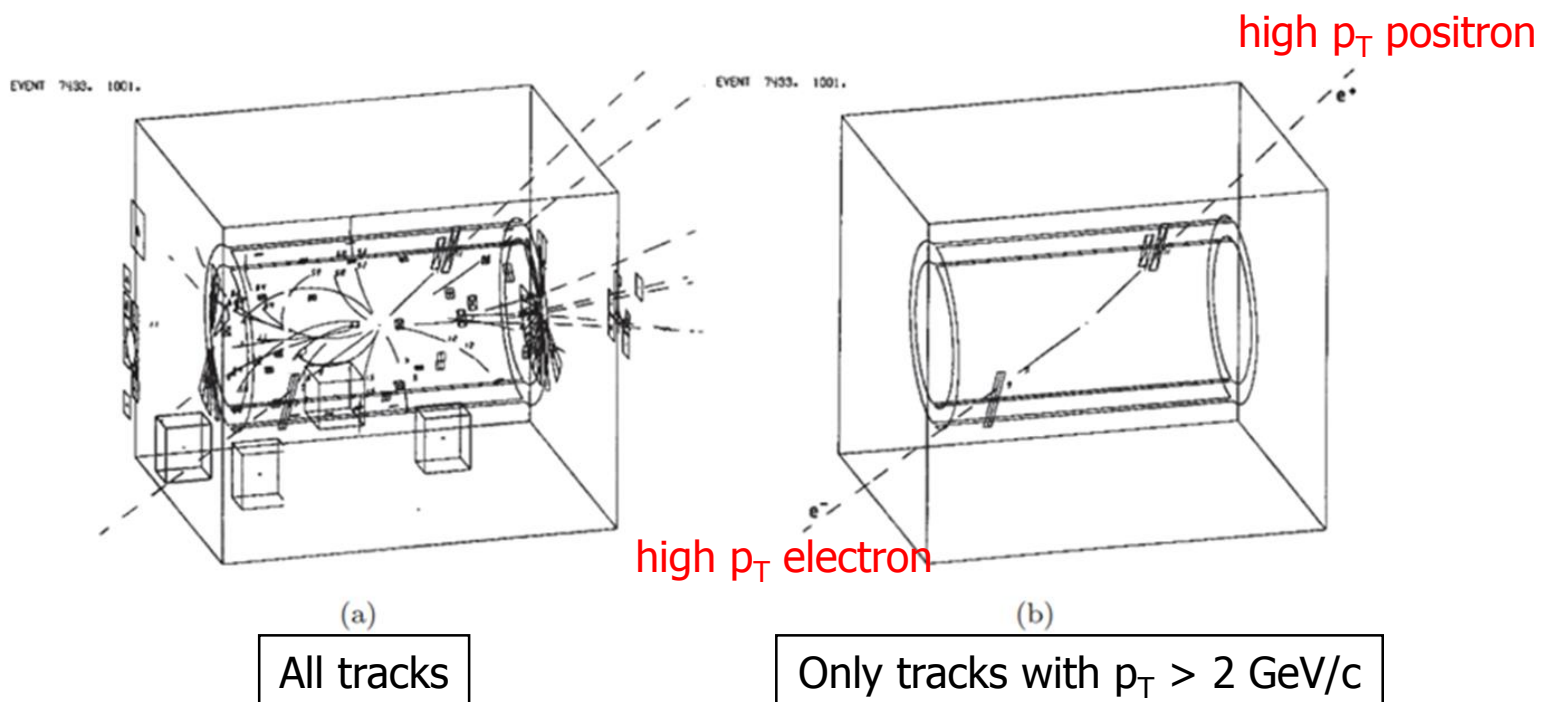

## Masses of the W and Z bosons (1982-1985)

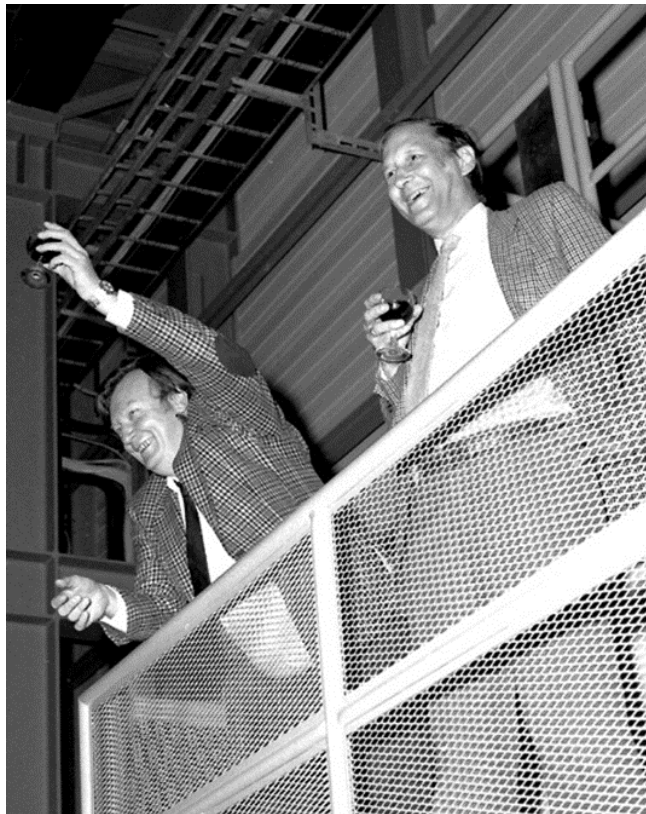

C. Rubbia & S. van der Meer  
Nobel Prize 1984

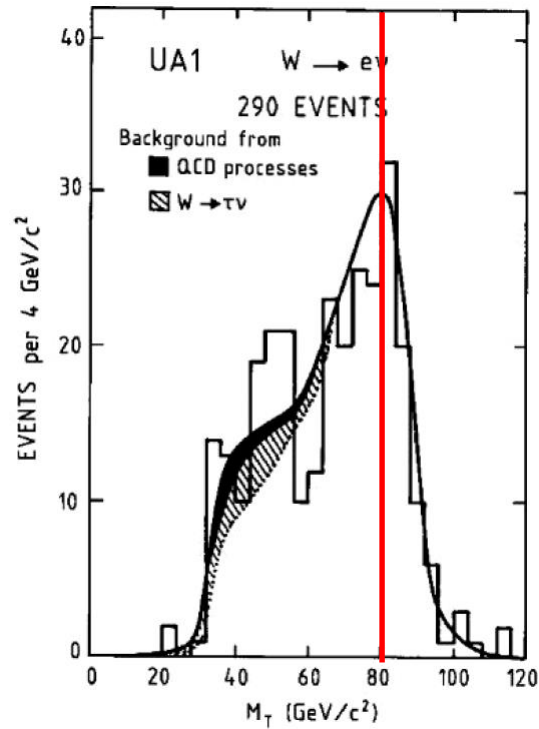

$m_W = 80.3 \text{ GeV}$

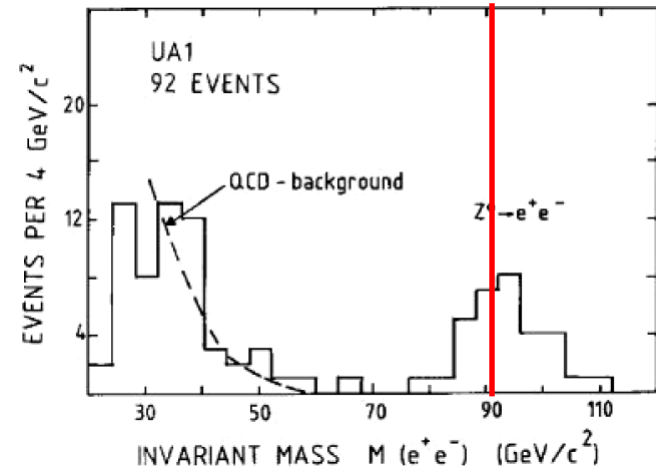

$m_Z = 91.2 \text{ GeV}$



# Superconductivity, key technology to high-energy accelerators

## Helps containing the increase in size and power consumption

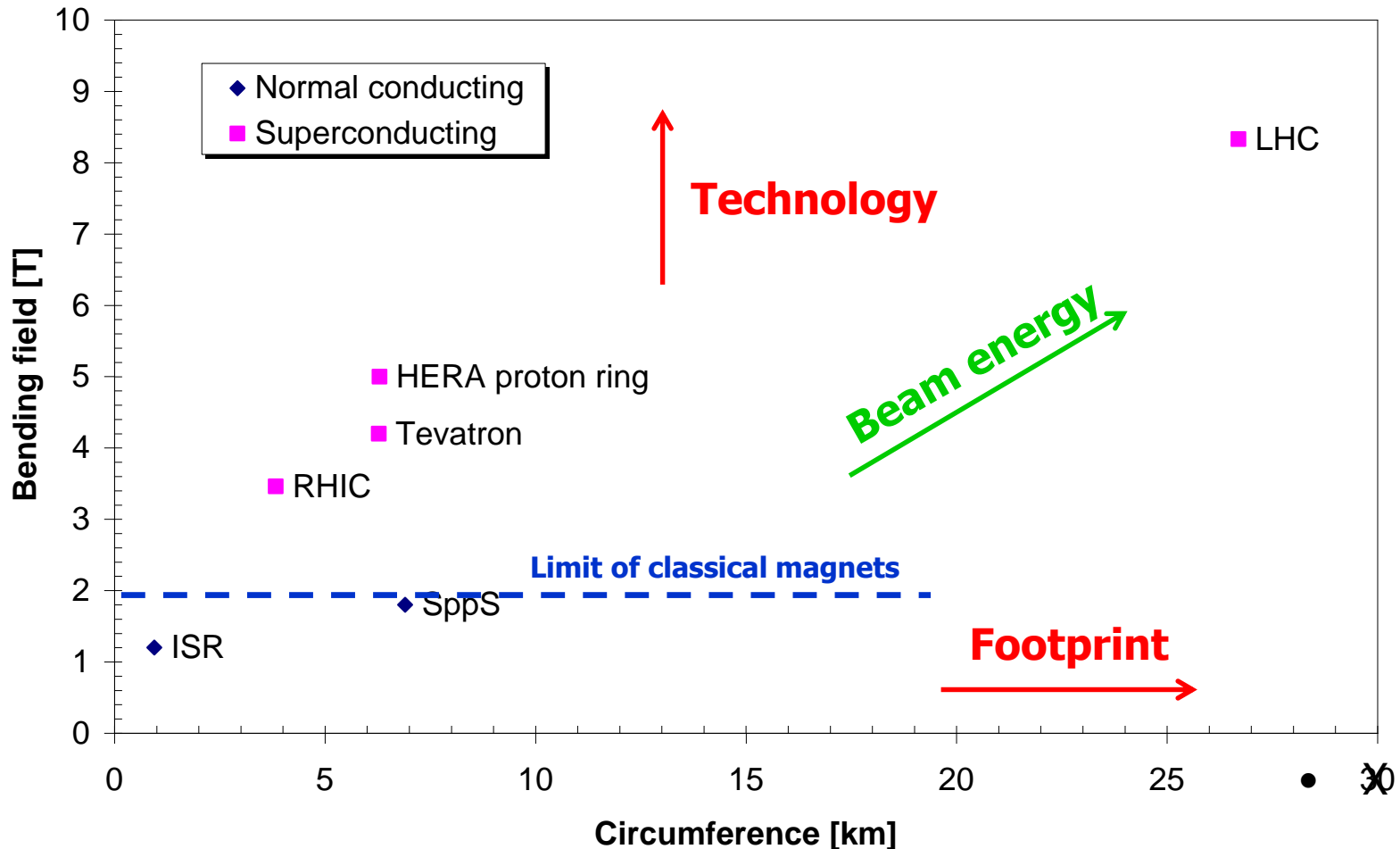

## High-luminosity insertion at the CERN ISR (1979) First superconducting magnets routinely operated in an accelerator

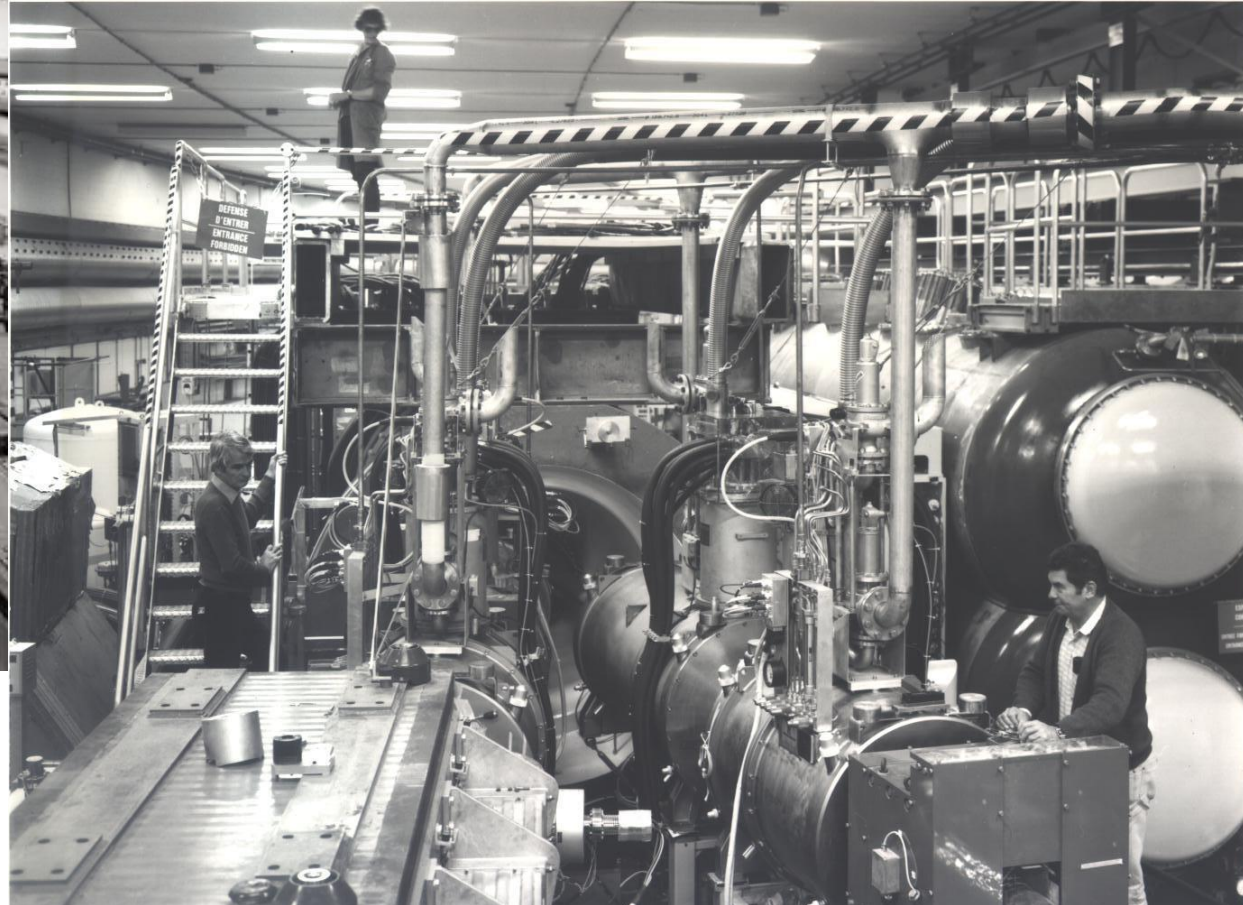
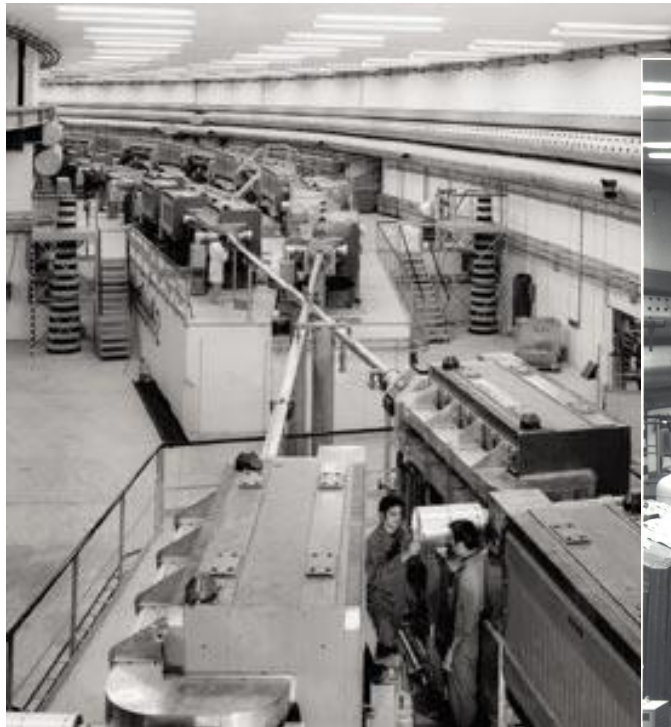

Seven-fold increase in luminosity  
Record value  $1.4 \times 10^{32} \text{ cm}^{-2} \text{ s}^{-1}$

# The Tevatron collider at Fermilab

## Colliding beams of protons and antiprotons accelerated at 980 GeV





# Discovery of the top quark, the heaviest particle (175 GeV) CDF and D0 detectors at the TeVatron (1995)

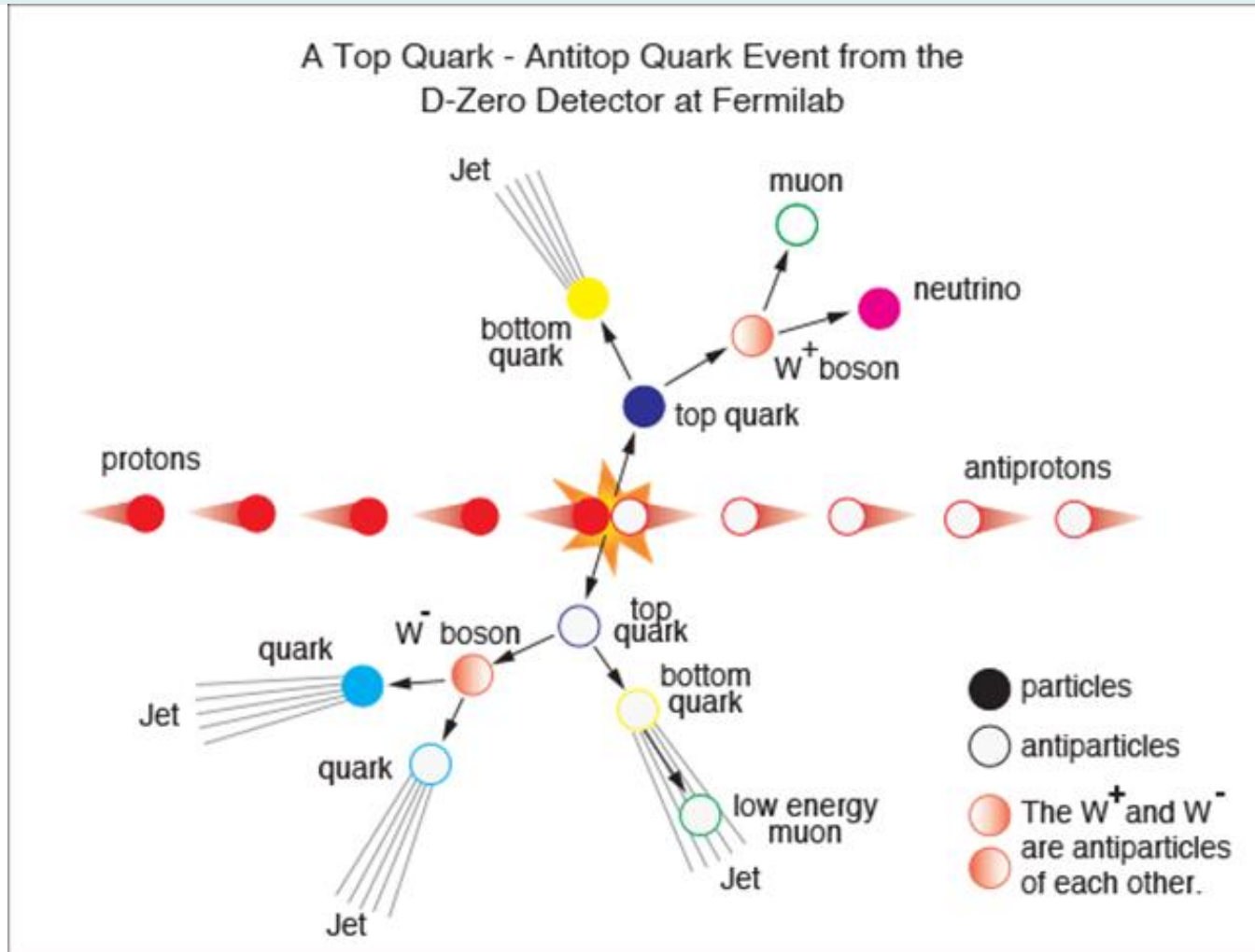

# Discovery of the top quark, the heaviest particle (175 GeV) CDF and D0 detectors at the TeVatron (1995)

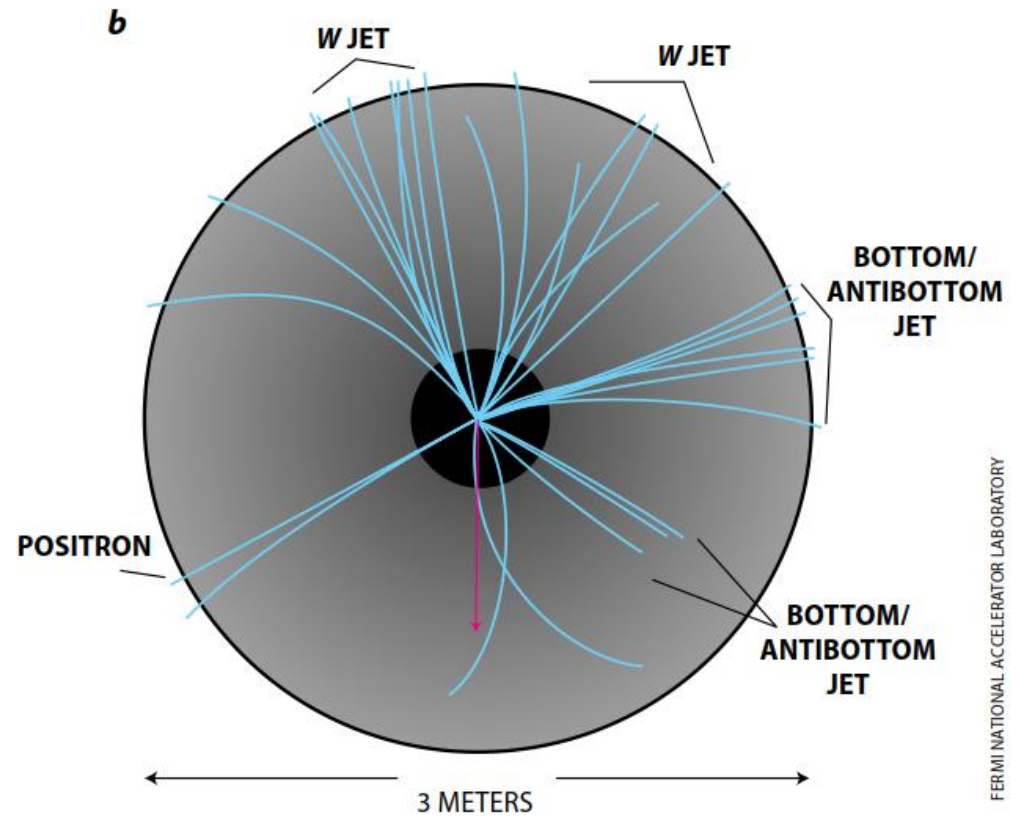
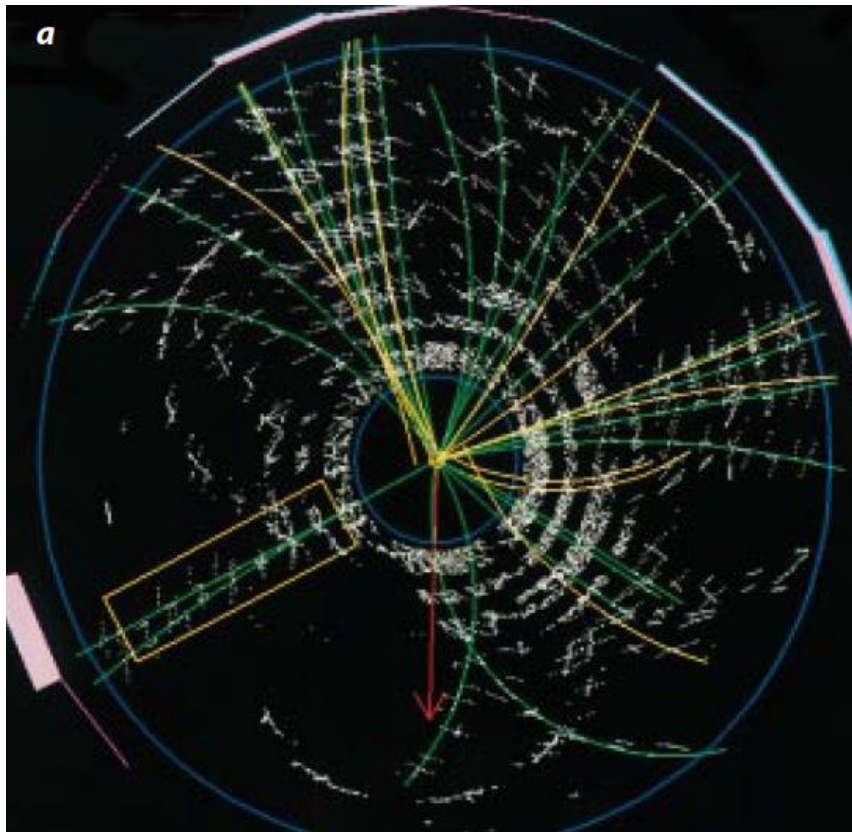

## Particle colliders [2/2]



LEP at CERN



HERA at DESY



LHC at CERN

- 1989, CERN starts operating the 26.7 km, high-energy electron-positron collider LEP
- 1989, SLAC starts operating the SLC, first linear collider converted from the linac
- 1991, HERA at DESY becomes the first proton-electron collider
- 1999, RHIC at BNL becomes the first heavy-ion collider
- 2008, CERN starts operation of the LHC, 14 TeV proton-proton collider
- 2012, design studies are published for electron-positron linear colliders, ILC and CLIC
- 2014, CERN launches design study for Future Circular Colliders (100 km circumference)



# The LEP electron-positron collider at CERN (1989-2000)

## Colliding electron and positron beams accelerated up to 104 GeV

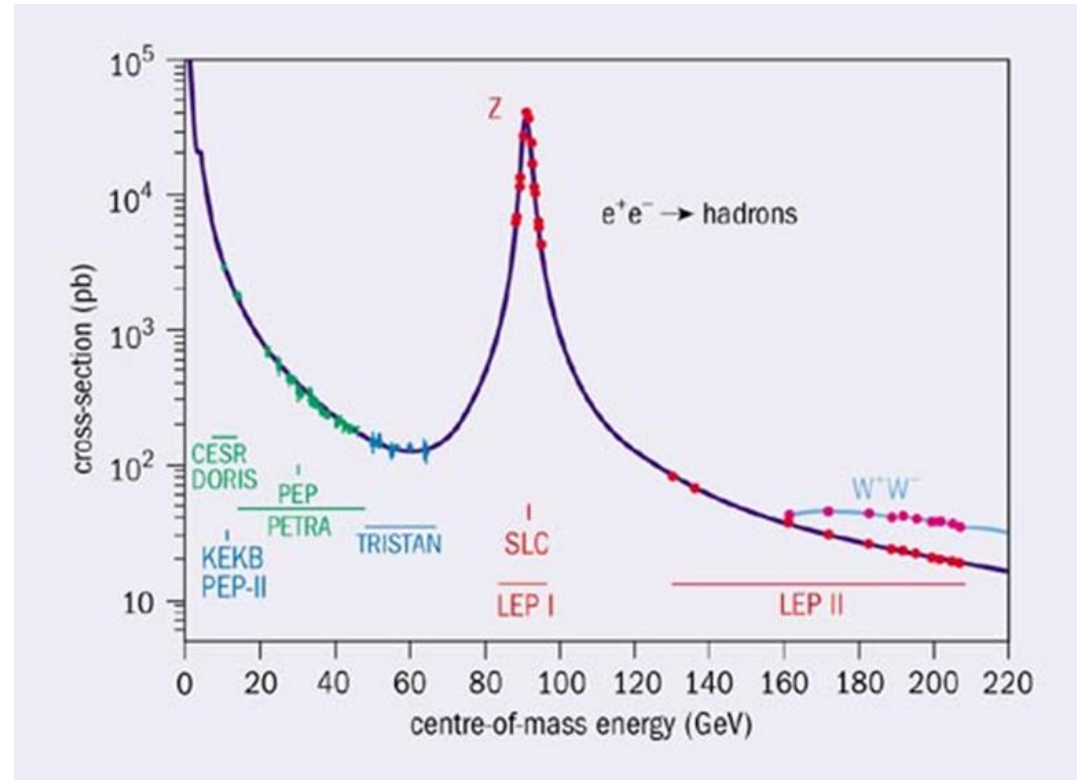
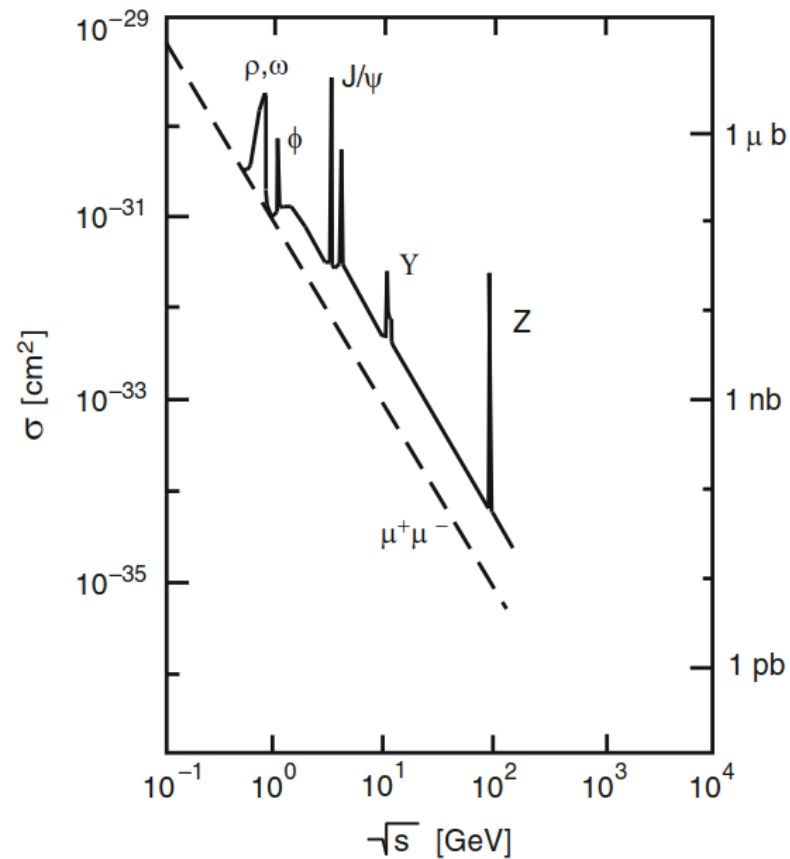

Mass production of W and Z bosons for precision physics

# Physics results at LEP

## Precise validation of the Standard Model

	Measurement	Pull	$(O^{\text{meas}} - O^{\text{fit}}) / \sigma^{\text{meas}}$
$\Delta\alpha_{\text{had}}^{(5)}(m_Z)$	$0.02761 \pm 0.00036$	-0.24	
$m_Z$ [GeV]	$91.1875 \pm 0.0021$	0.00	
$\Gamma_Z$ [GeV]	$2.4952 \pm 0.0023$	-0.41	
$\sigma_{\text{had}}^0$ [nb]	$41.540 \pm 0.037$	1.63	
$R_l$	$20.767 \pm 0.025$	1.04	
$A_{\text{fb}}^{0,l}$	$0.01714 \pm 0.00095$	0.68	
$A_l(P_\tau)$	$0.1465 \pm 0.0032$	-0.55	
$R_b$	$0.21644 \pm 0.00065$	1.01	
$R_c$	$0.1718 \pm 0.0031$	-0.15	
$A_{\text{fb}}^{0,b}$	$0.0995 \pm 0.0017$	-2.62	
$A_{\text{fb}}^{0,c}$	$0.0713 \pm 0.0036$	-0.84	
$A_b$	$0.922 \pm 0.020$	-0.64	
$A_c$	$0.670 \pm 0.026$	0.06	
$A_l(\text{SLD})$	$0.1513 \pm 0.0021$	1.46	
$\sin^2\theta_{\text{eff}}^{\text{lept}}(Q_{\text{fb}})$	$0.2324 \pm 0.0012$	0.87	
$m_W$ [GeV]	$80.449 \pm 0.034$	1.62	
$\Gamma_W$ [GeV]	$2.136 \pm 0.069$	0.62	
$m_t$ [GeV]	$174.3 \pm 5.1$	0.00	
$\sin^2\theta_W(\nu N)$	$0.2277 \pm 0.0016$	3.00	
$Q_W(\text{Cs})$	$-72.18 \pm 0.46$	1.52	

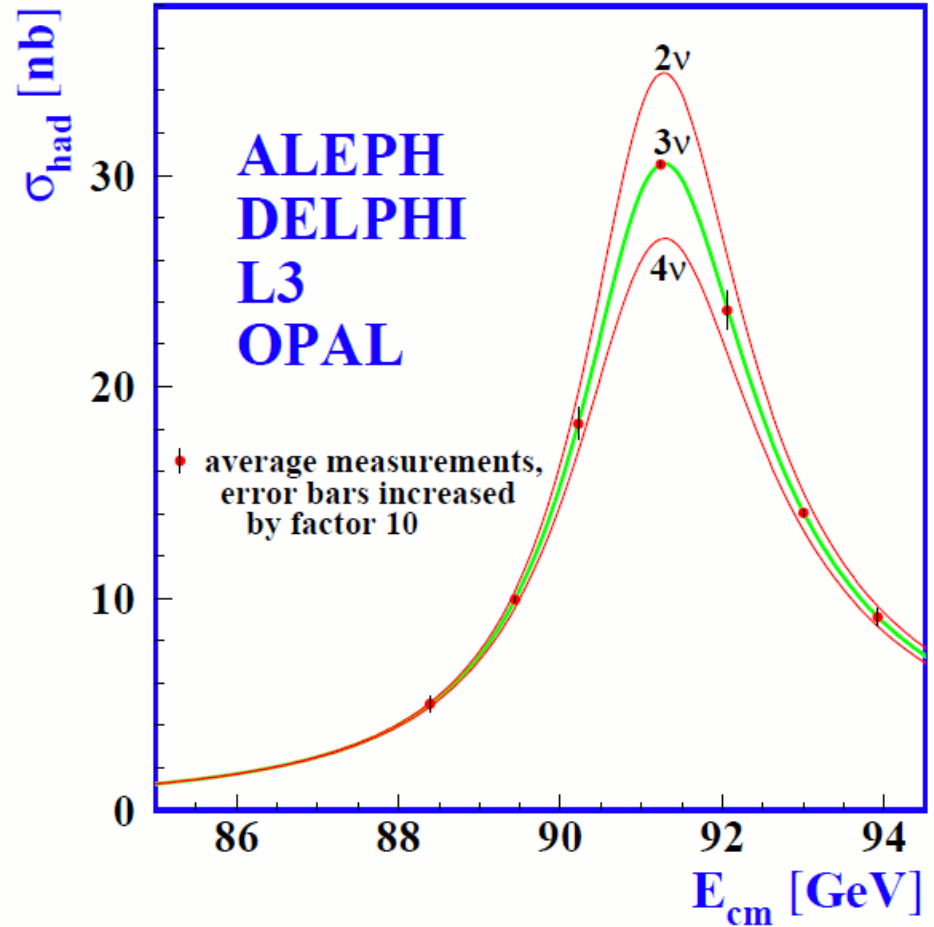

# The LHC and its two multi-purpose detectors at CERN

## Colliding beams of protons accelerated at 7 TeV

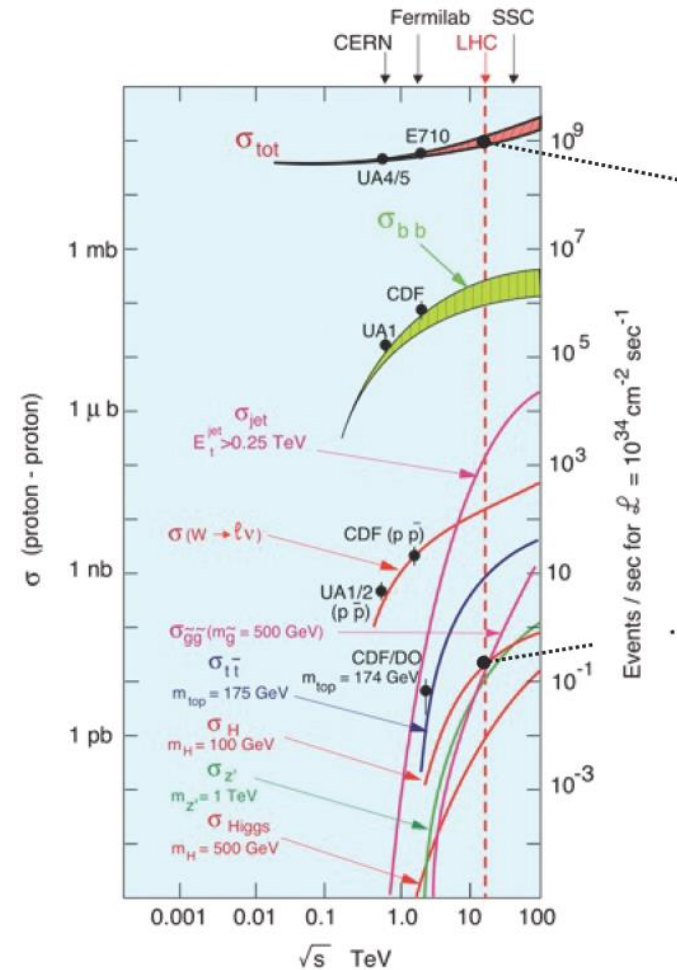
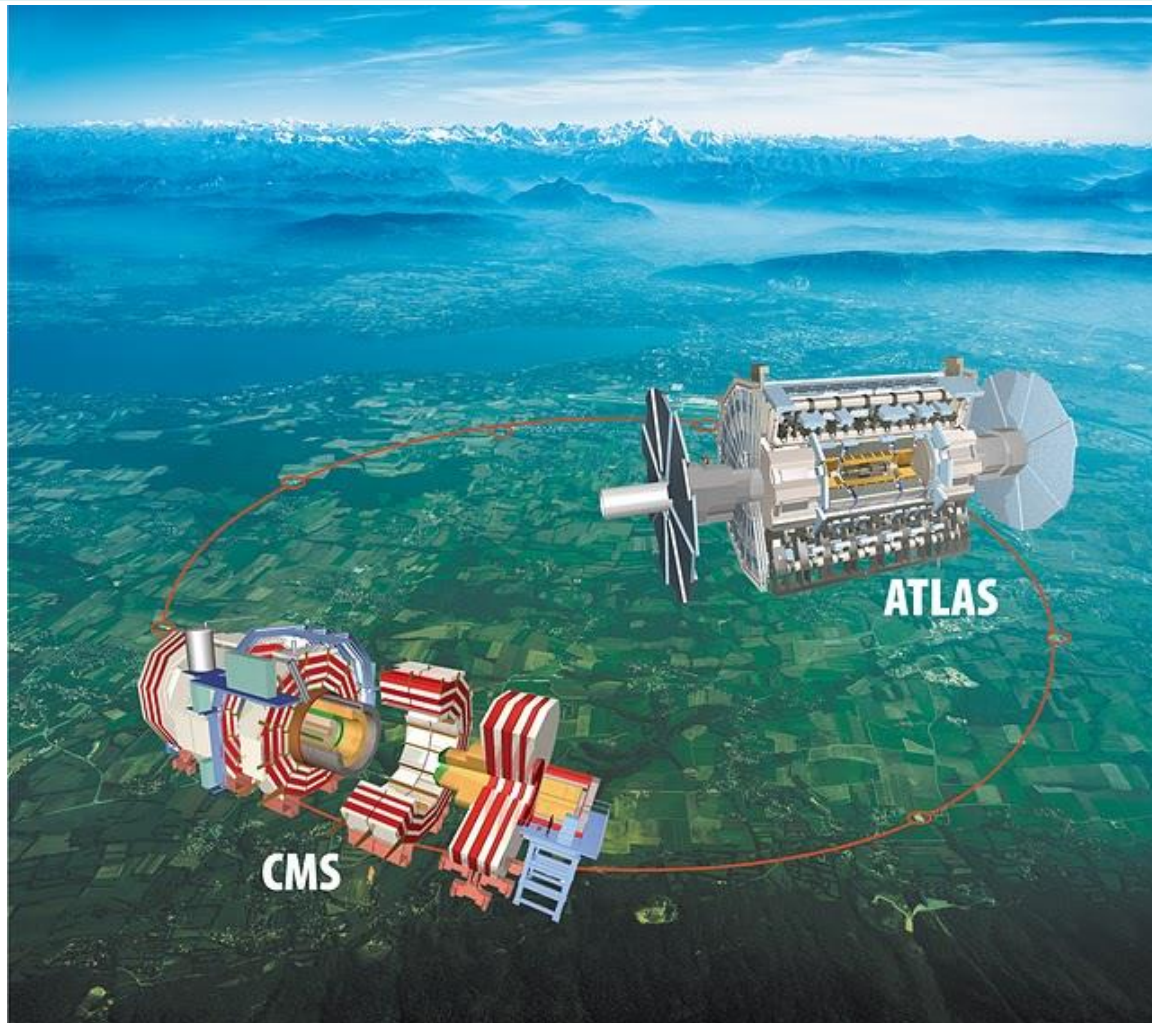



# Discovery of the 125 GeV Higgs boson (2012)

The decays of the Higgs boson, observed in the CMS and ATLAS detectors

$$H \rightarrow \gamma\gamma$$

$$H \rightarrow ZZ \rightarrow 4l$$

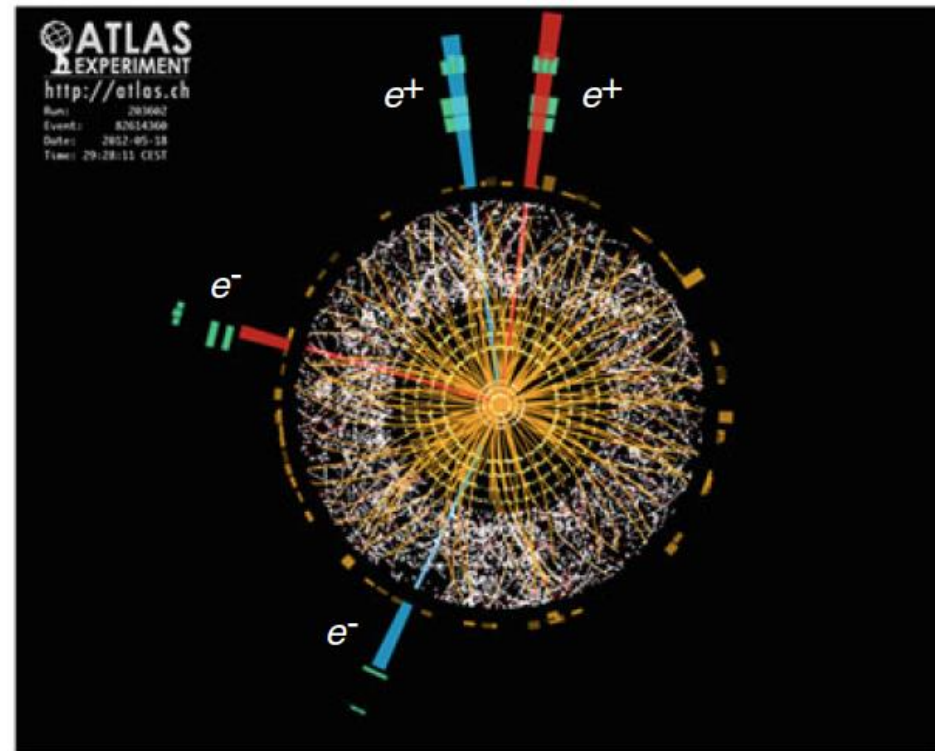
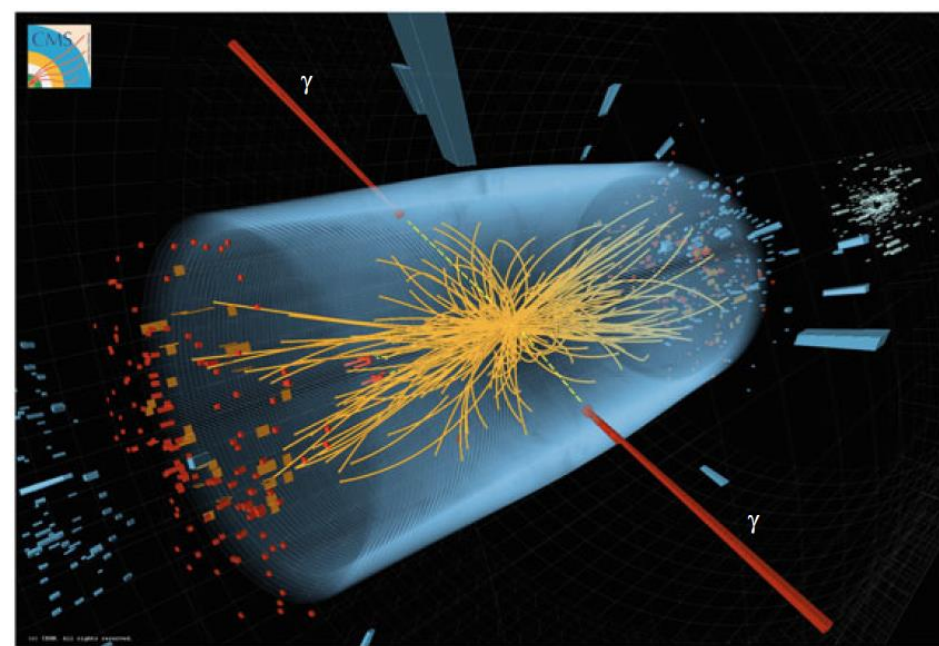

# Discovery of the 125 GeV Higgs boson (2012)

## The decays of the Higgs boson, observed in the CMS and ATLAS detectors

$$H \rightarrow \gamma\gamma$$

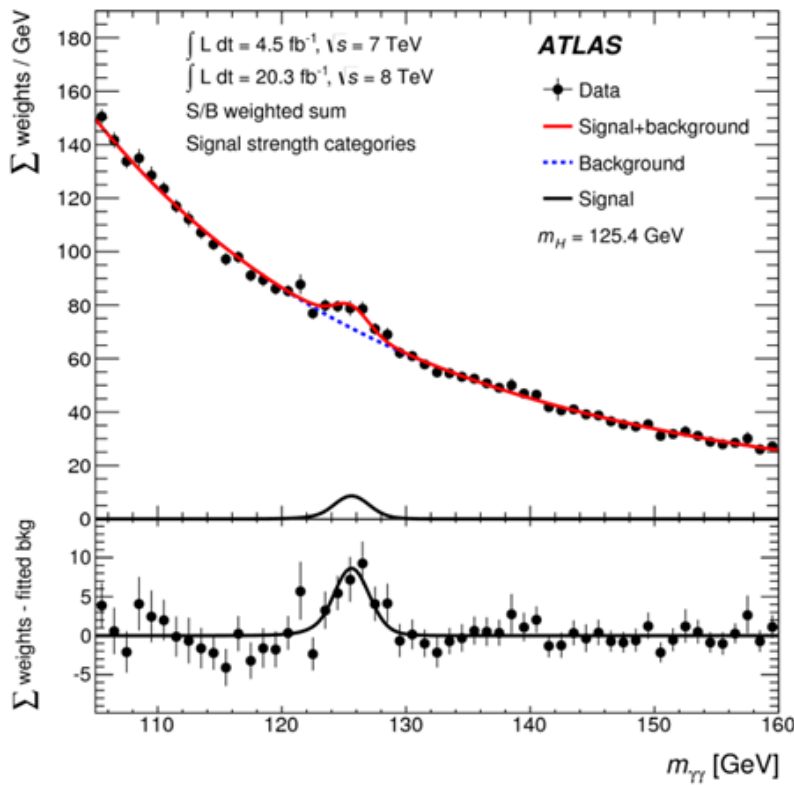

$$H \rightarrow ZZ \rightarrow 4l$$

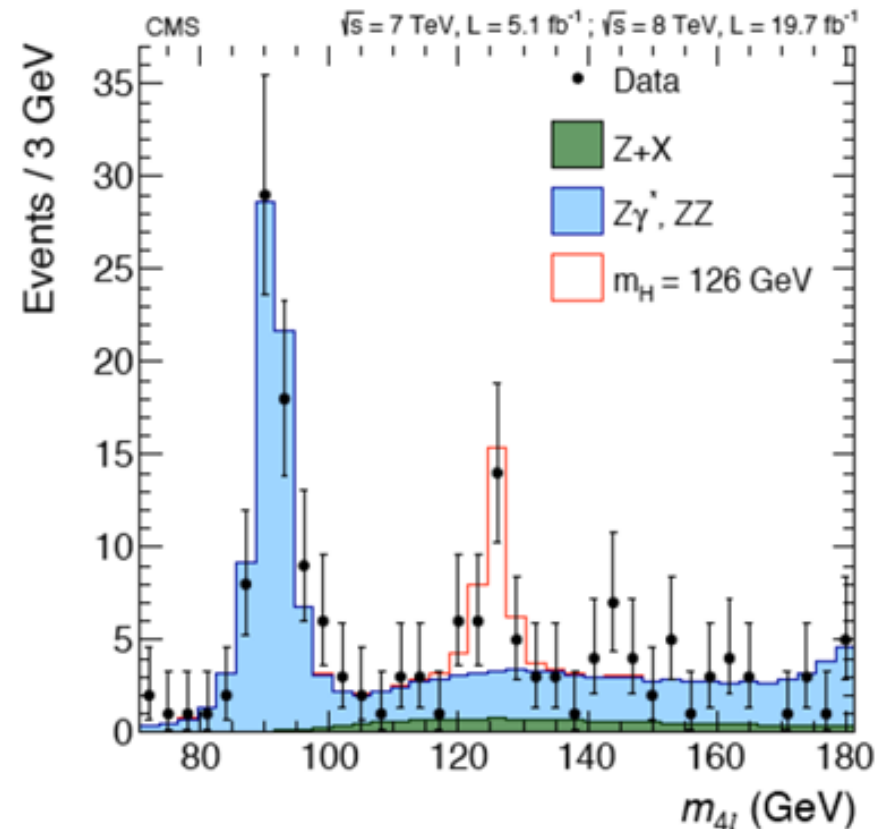

# The Higgs boson complements the Standard Model... ...but does not answer all questions

- Is this description of nature still valid at higher energies (i.e. smaller scale)?
- How should it be modified to account for unexplained phenomena such as
  - matter-antimatter asymmetry
  - dark matter in the universe
  - cosmological inflation
  - quantum gravity
  - ...

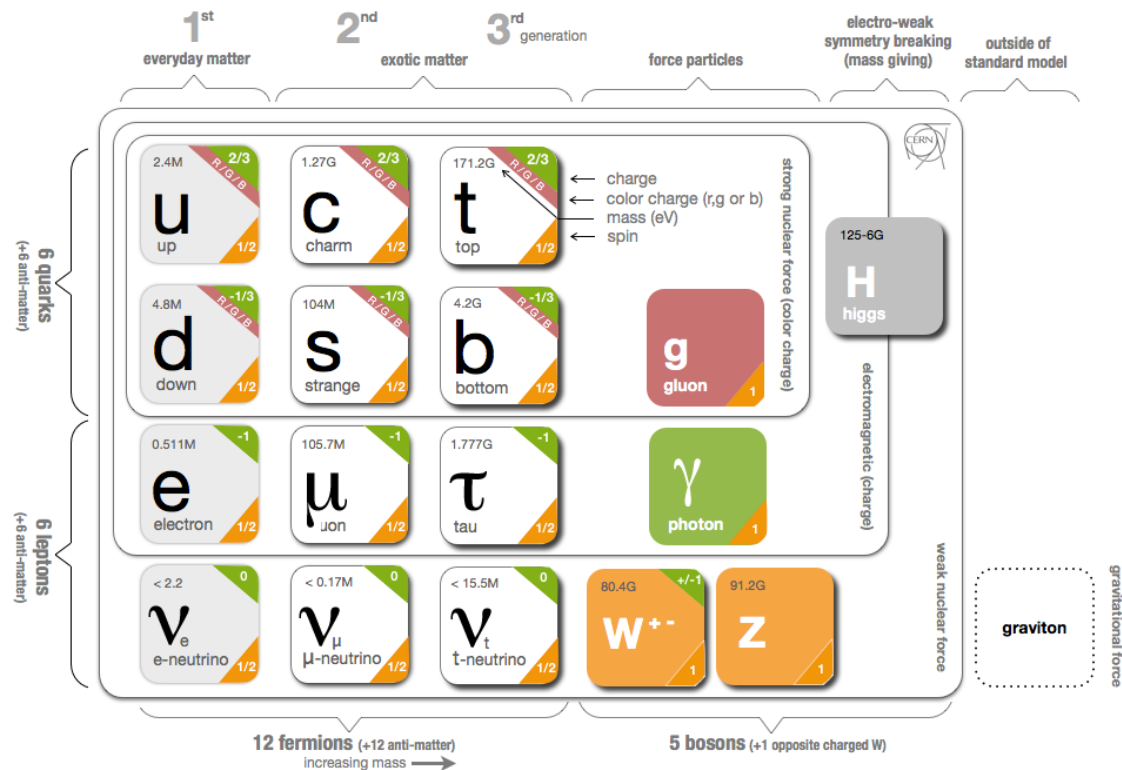



# After the LHC...

## A large linear electron-positron collider (CLIC study)?

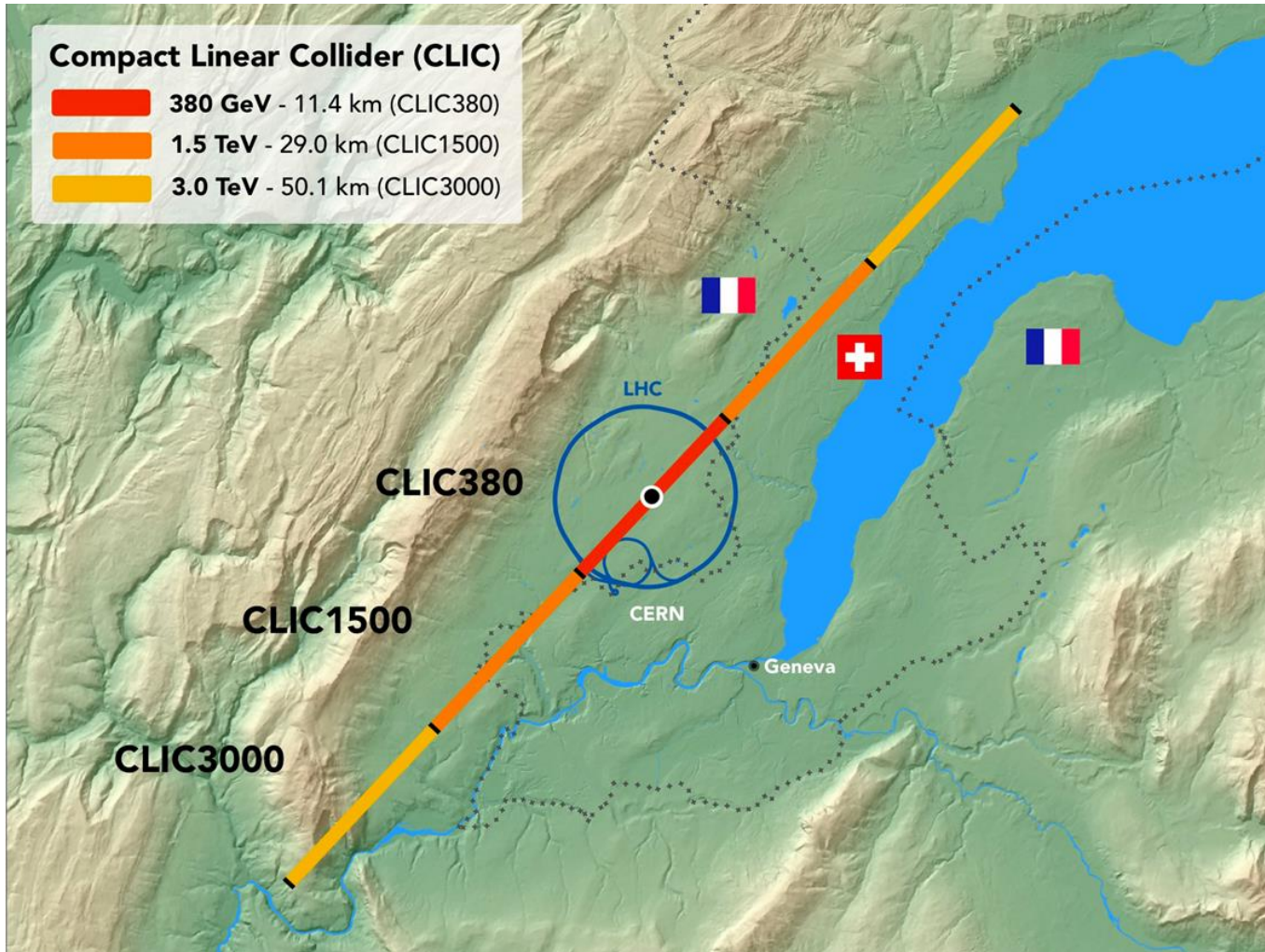

## After the LHC... A large circular proton collider (FCC study)?

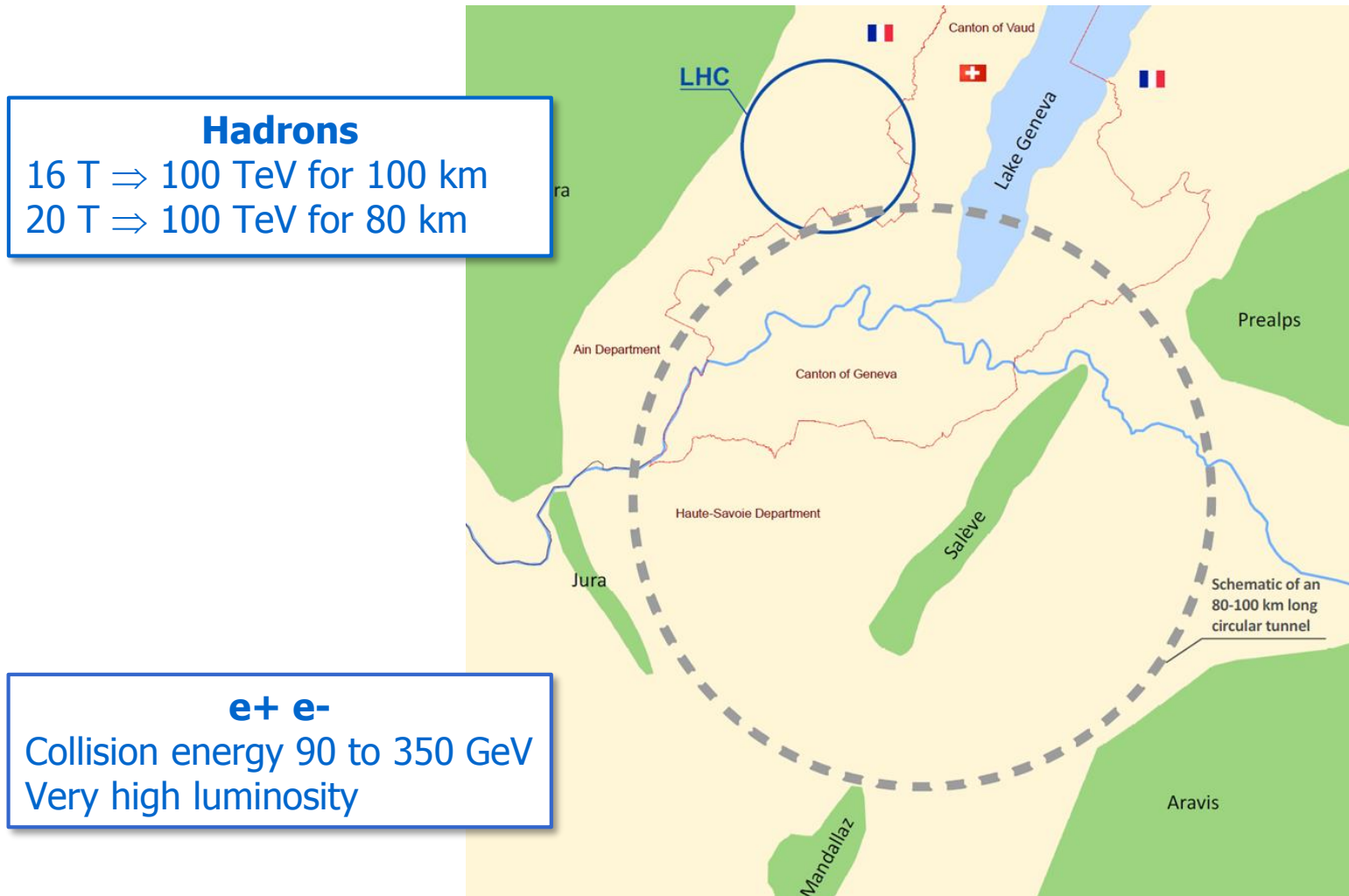

## Accelerators contributed to 26 Nobel Prizes in physics since 1939

- 1939 Ernest O. Lawrence
- 1951 John D. Cockcroft & Ernest Walton
- 1952 Felix Bloch
- 1957 Tsung-Dao Lee & Chen Ning Yang
- 1959 Emilio G. Segrè & Owen Chamberlain
- 1960 Donald A. Glaser
- 1961 Robert Hofstadter
- 1963 Maria Goeppert Mayer
- 1967 Hans A. Bethe
- 1968 Luis W. Alvarez
- 1976 Burton Richter & Samuel C.C. Ting
- 1979 Sheldon L. Glashow, Abdus Salam & Steven Weinberg
- 1980 James W. Cronin & Val L. Fitch
- 1981 Kai M. Siegbahn
- 1983 William A. Fowler
- 1984 Carlo Rubbia & Simon van der Meer
- 1986 Ernst Ruska
- 1988 Leon M. Lederman, Melvin Schwartz & Jack Steinberger
- 1989 Wolfgang Paul
- 1990 Jerome I. Friedman, Henry W. Kendall & Richard E. Taylor
- 1992 Georges Charpak
- 1995 Martin L. Perl
- 2004 David J. Gross, Frank Wilczek & H. David Politzer
- 2008 Makoto Kobayashi & Toshihide Maskawa
- 2013 François Englert & Peter Higgs
- 2015 Takaaki Kajita & Arthur B. MacDonald



## Particle accelerators: the complete picture

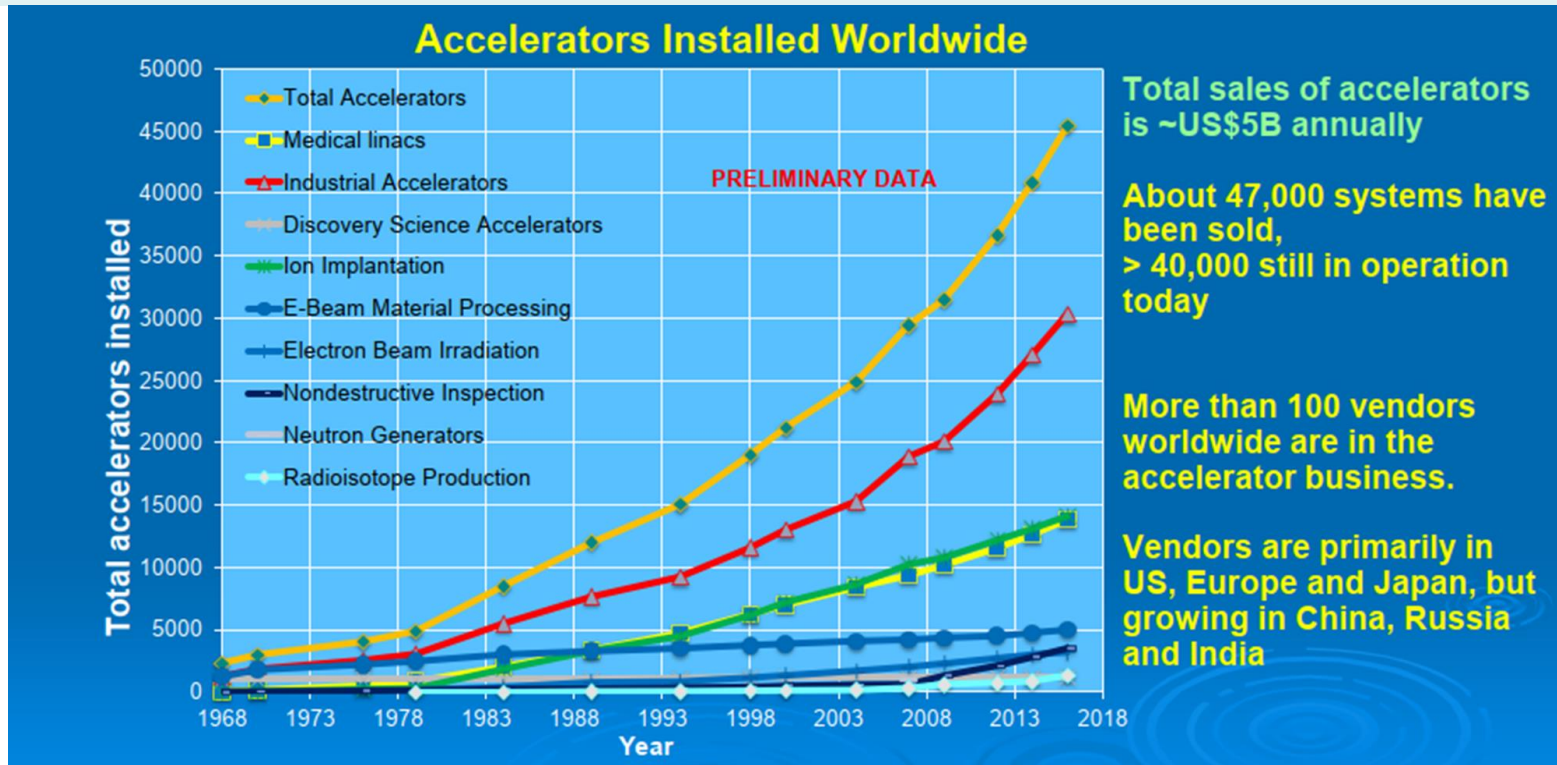

- Accelerators for particle physics described in this lecture account for only ~1 % of the total number of these machines in service in the world
- Most accelerators serve applications in industry and medicine... but this is another story!

## Acknowledgements

- In preparing this lecture, I borrowed material and information from the following
  - U. Amaldi, *History of particle accelerators* (lecture)
  - J. Ellis et al. (ed), *CERN: the second 25 years*, Phys. Rep. 403-404 (2004)
  - L. Di Lella & C. Rubbia, *The discovery of the W and Z particles*, in *60 years of CERN experiments and discoveries*, World Scientific (2015)
  - R.E. Taylor, *The discovery of the point-like structure of matter*, SLAC-PUB-8640 (2000)
  - D. Treille, *Fifty years of research at CERN and elsewhere* (private communication)
  - V. Vaccaro, *Not all but a bit of all about accelerators* (lecture)
  - L. Van Hove & L. Di Lella (ed.), *Highlights of 25 years of physics at CERN*, Phys. Rep. 62 (1980)
  - S. Weinberg, *The discovery of subatomic particles*, Cambridge University Press (2003)

## Particle accelerators: the complete picture

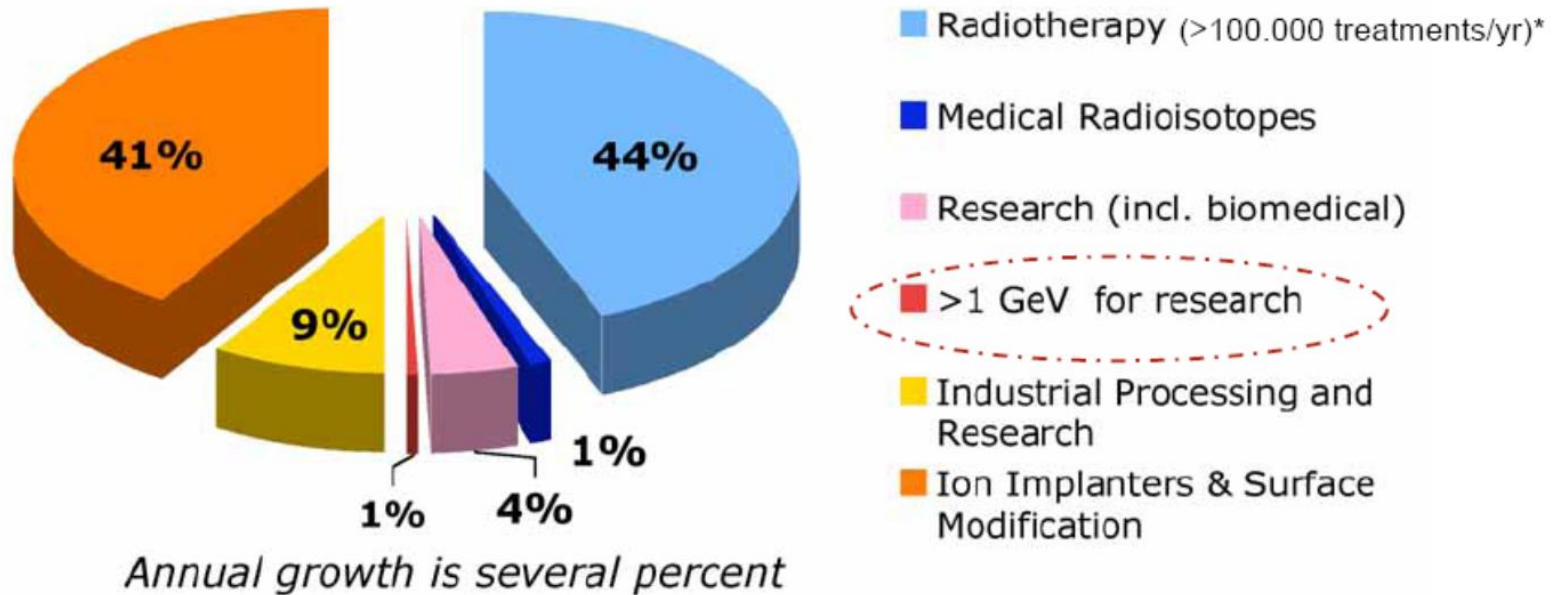

- Accelerators for particle physics described in this lecture account for only  $\sim 1\%$  of the total number of these machines in service in the world
- Most accelerators serve applications in industry and medicine... but this is another story!