



UNIVERSITÀ DEGLI STUDI DI NAPOLI  
**FEDERICO II**



# **From Rutherford to Colliders: the Riveting Story of Accelerators**

**Prof. Vittorio Giorgio VACCARO**

# AT THAT TIME.....(around 1910)

- At that time (about a century ago) radioactivity was most popular among the physics community. From about ten years it was discovered by Becquerel in France. The Curie's, and then the widowed Mrs. Curie-Sklodowska alone, succeeded with a titanic work to isolate various radioactive elements. Within a very short time the majority of physicists and chemists of the world rushed in research on radioactivity.

# AT THAT TIME

Almost on all High School Physics books it may be found the schematic representation of the experiment which led to the discovery of radioactivity

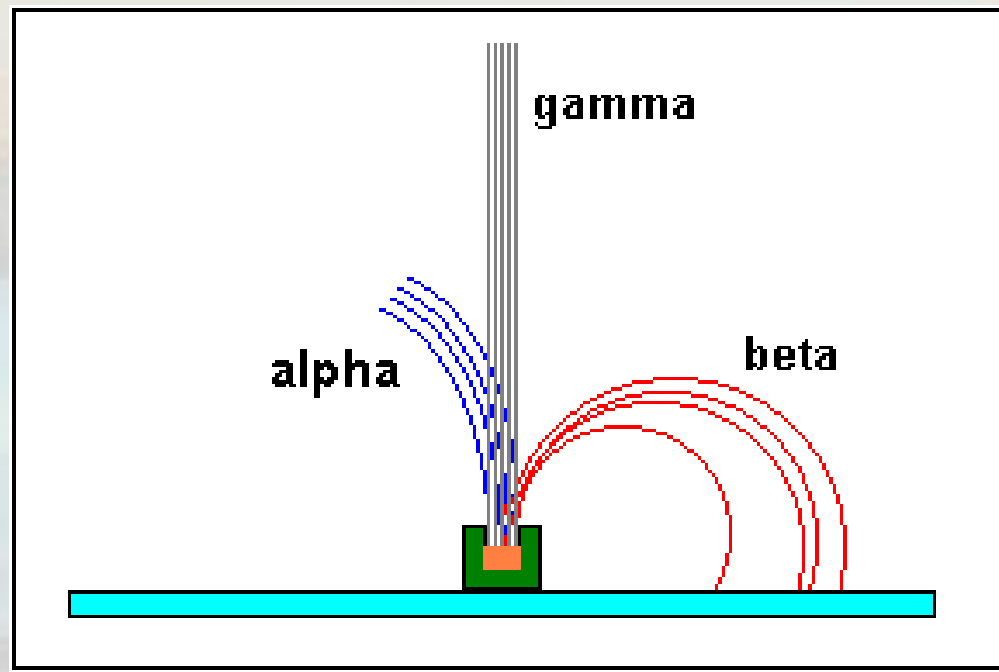

The magnetic field is orthogonal to the picture plane

# AT THAT TIME

Among the physicists, it was common belief that matter was made of atoms and that these consisted of positive and negative charges (electrons), but nothing was known about the arrangement of positive charges within the atom.

Thomson's atom

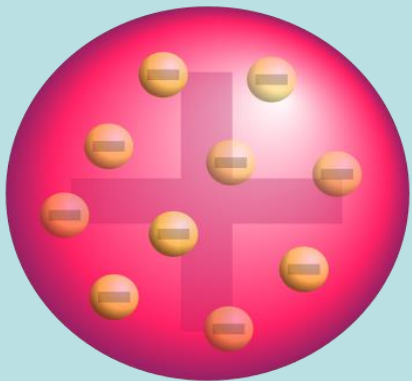

Nagaoka's atom

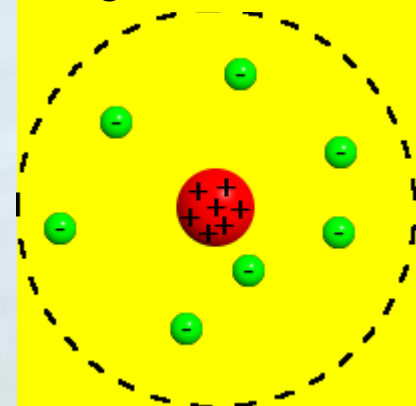

# The Prehistory: Rutherford

In 1908 Ernest Rutherford was awarded of the Nobel Prize for chemistry. The award citation states: "for his investigations into the disintegration of the elements, and the chemistry of radioactive substances." Among others, he had discovered that the radioactive element thorium released a *radioactive* gas. Its *activity* consisted in *radiating* energetic alpha particle (ionized Helium atoms of about 4GeV). His idea was to use them as projectiles for investigating on the atom structure:

**BRUTE FORCE METHOD**

**THE ACCELERATOR ERA WAS BORN**

# Two models in comparison

This classic diffraction experiment was conducted in 1911 by Hans Geiger and Ernest Marsden at the suggestion of Ernest Rutherford

*[Rutherford was] a "tribal chief", as a student said.*

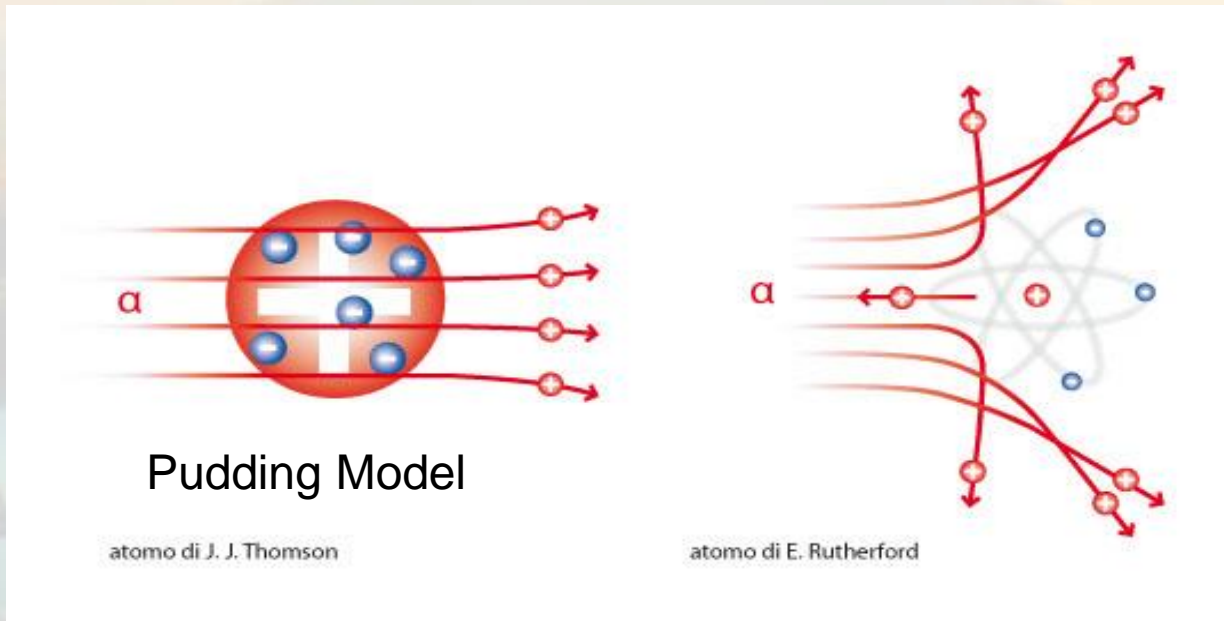

# The crucial experiment

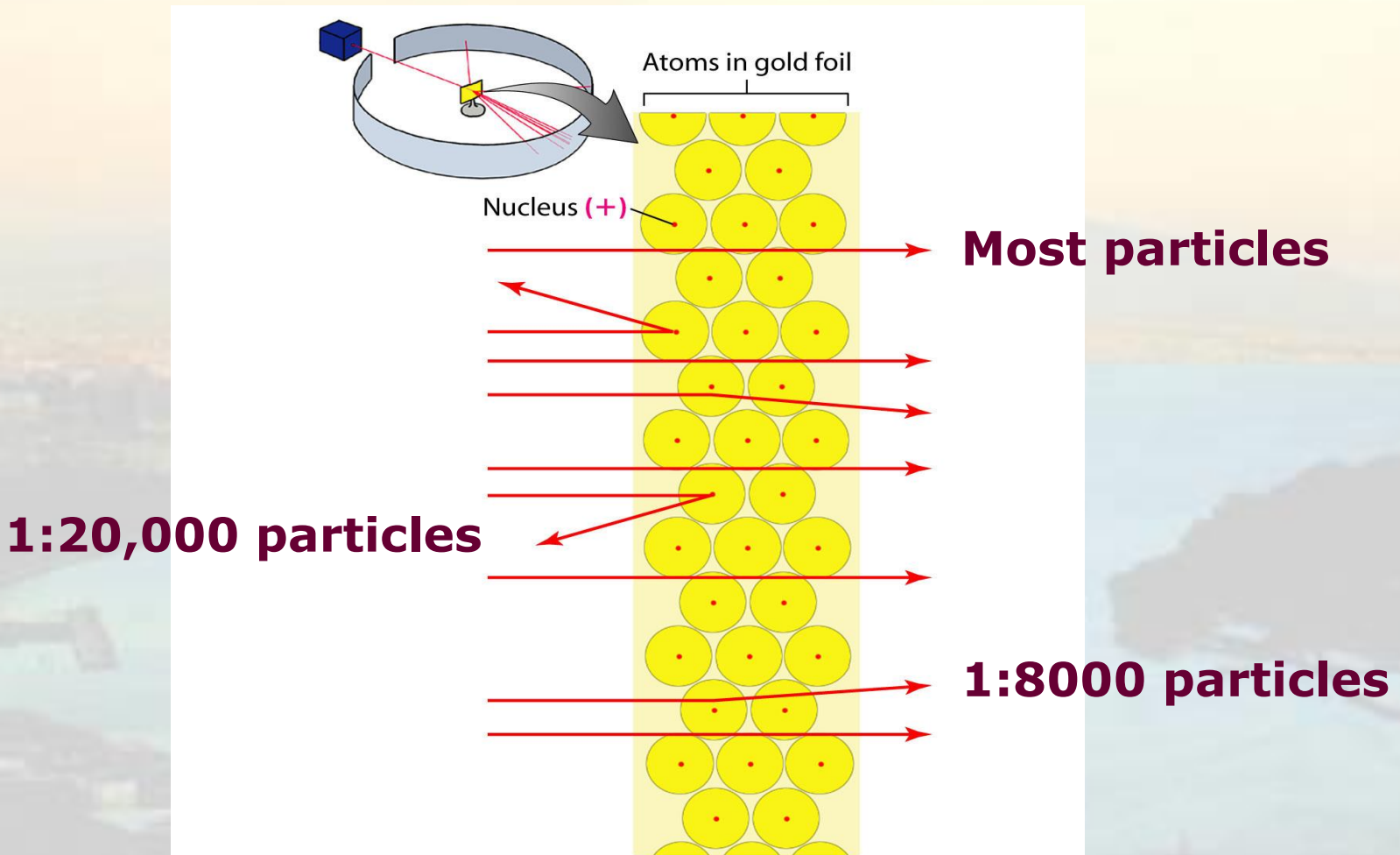

From *Conceptual Chemistry*, Second Edition by John Suchocki. Copyright © 2004 Benjamin Cummings, a division of Pearson Education.



# Impact Parameter

- Besides the masses of the target and projectile, the scattering angle depends upon the force and upon the impact parameter. The impact parameter is the perpendicular distance to the closest approach if the projectile were undeflected.

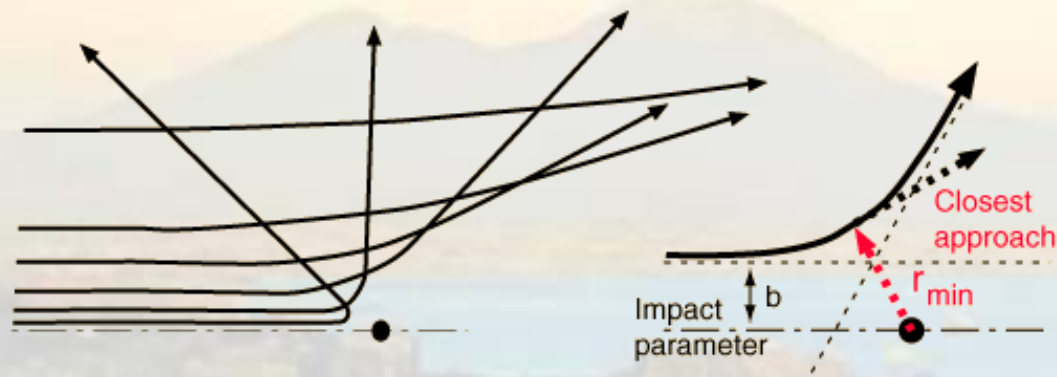

Rutherford already knew that the trajectory of particle subjected to a repulsive force (proportional to the inverse of the squared distance) was an hyperbola.

This problem was in the program of studies of the secondary school (1885!) he attended in New Zealand!



# Rolf Wideroe

- during his studies at the University of Aachen, Rolf Wideroe , barely 20 years old, had already dreamed of making a "radiation transformer ", **later called betatron**, which was very important in the production of X-rays in hospitals.



# Rolf Wideröe

The genius of this idea lies in the fact that the magnetic field, in addition to bend the charged particles trajectory keeping them on a circular orbit (Lorentz force), the particle energy increases when the magnetic field intensifies (Faraday law). He presented this project as a PhD thesis in engineering at the University of Aachen.

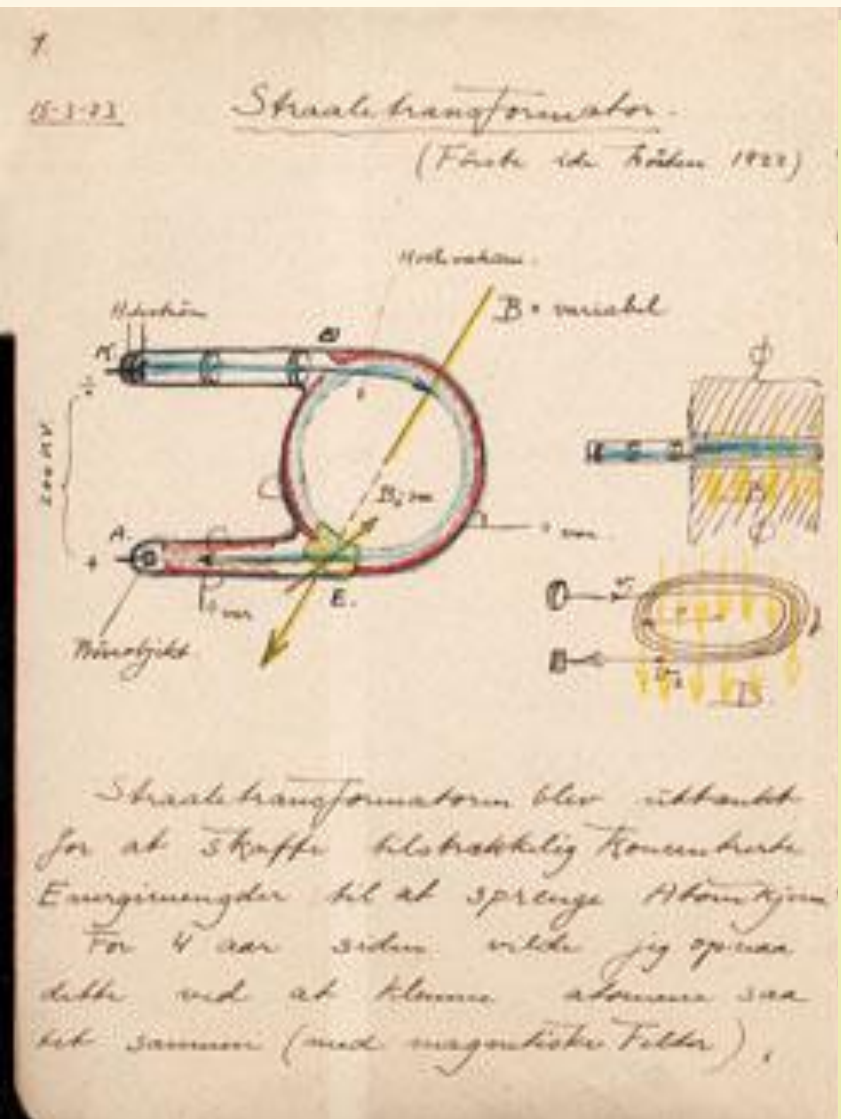

Rolf Wideroe  
Formula

$$B_{orbit} = \frac{1}{2} B_{gap}$$

Lorentz force  $e\bar{v} \times \bar{B}$

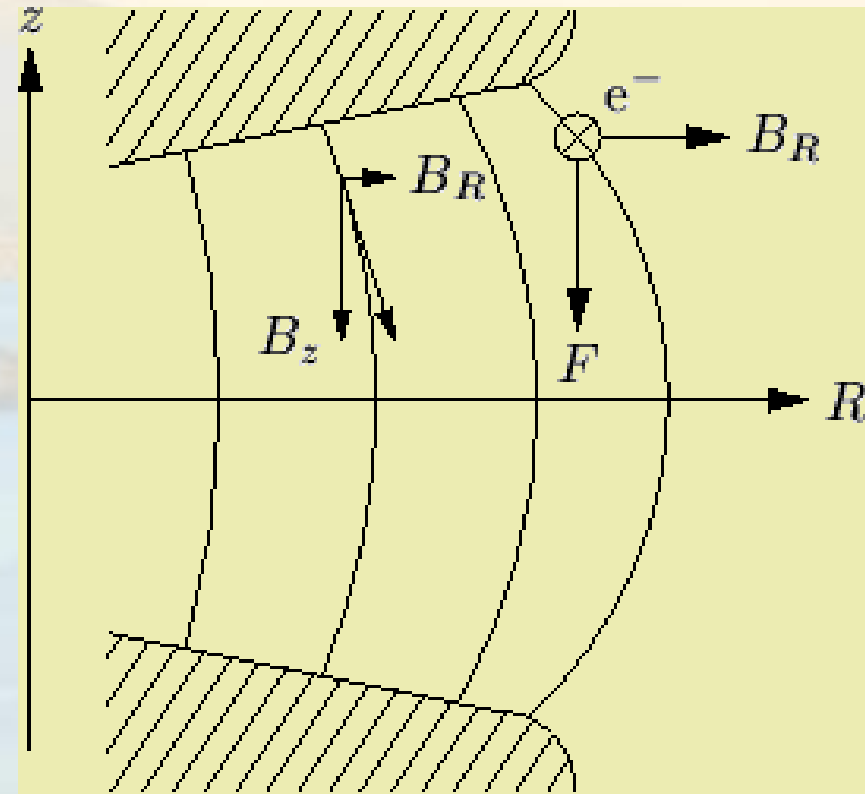
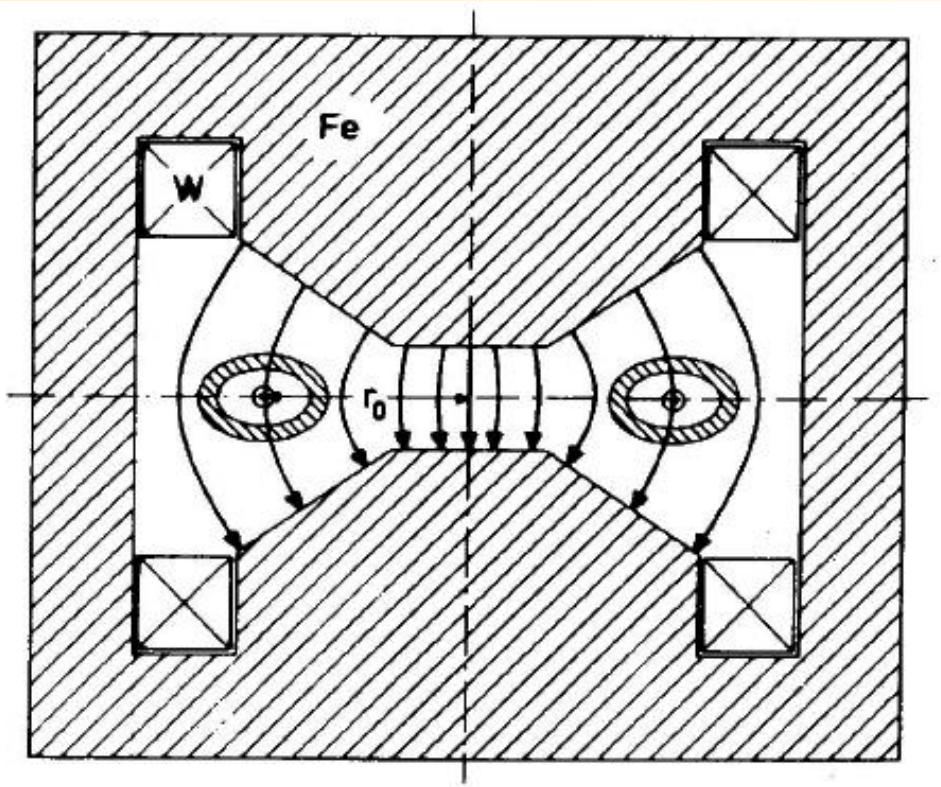

Find a good compromise between the vertical and horizontal focusing

# 1. Highlight

- Particles may oscillate vertically and horizontally around the reference orbit: **Betatron Oscillations**. This nomenclature was later extended to oscillation around the reference orbit in any accelerator. The ratio between that frequency and the particle revolution frequency is called **betatron** wave-number
- The magnet is multi-task (bending, focusing, accelerating). The forthcoming newly designed accelerators will tend to keep those functions separated.

# The Betatron

The transformer was built, but the experiment failed for insufficient vertical focusing.

The Betatron, reinvented by Donald Kerst in 1940, was historically employed in particle physics experiments to provide high energy electron beams up to about 300 MeV. If the electron beam is directed on a metal plate, the betatron can be used as a an intense source of energetic X-rays or gamma rays; X-rays may be used in industrial and medical applications (mainly in radiation oncology)



# Donald William Kerst



Vintage atmosphere: Kerst is wearing a double-breasted suit.

# Wideroe 2nd attempt

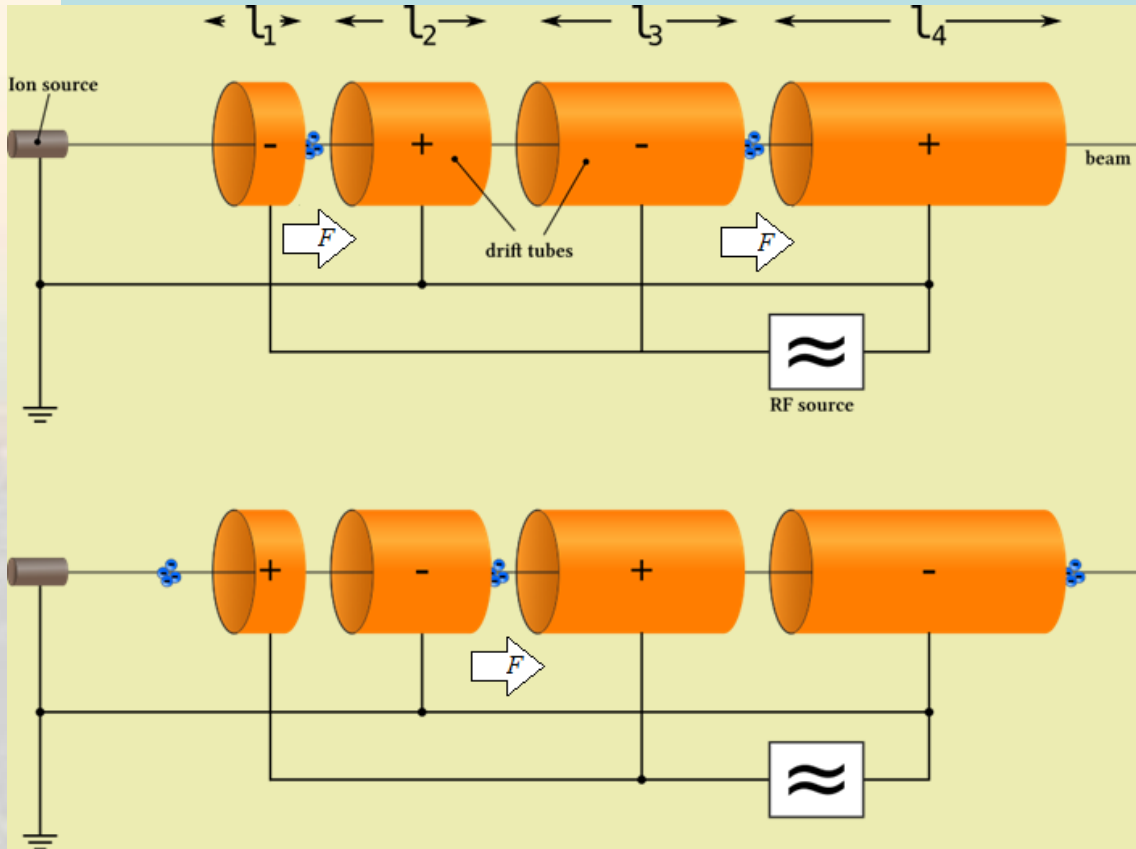

Wideroe did not give up, then he built a "linear accelerator" or "linac", as it is currently called. This consists of tubes known as "sliding" or drift tubes of variable length, to which a voltage with appropriate frequency is applied. He managed to accelerate atomic nuclei (Mercury ??) up to 25 keV / u.

Sketch of the **Ising-Widerøe** linear accelerator concept, employing oscillating fields (1928)



## 2. Highlight

- Radiofrequency accelerates and bunches only a part of the beam and rejects the complementary part.
- Even if no magnet was employed for focusing, the optimization of the beam quality imposes their use.

# Meanwhile... Cockcroft & Walton

- The thrust impressed by Rutherford bore fruit that matured after the break of the First World War: accelerators based on **potential drop**.
- In the late 20's, Cockcroft & Walton, two researchers belonging to Rutherford's School, made use of a new device that technology recently offered them: the diode. They built the apparatus shown in the following page. Despite the complexity, seeming only, the apparatus is simple

# Cockcroft & Walton ..

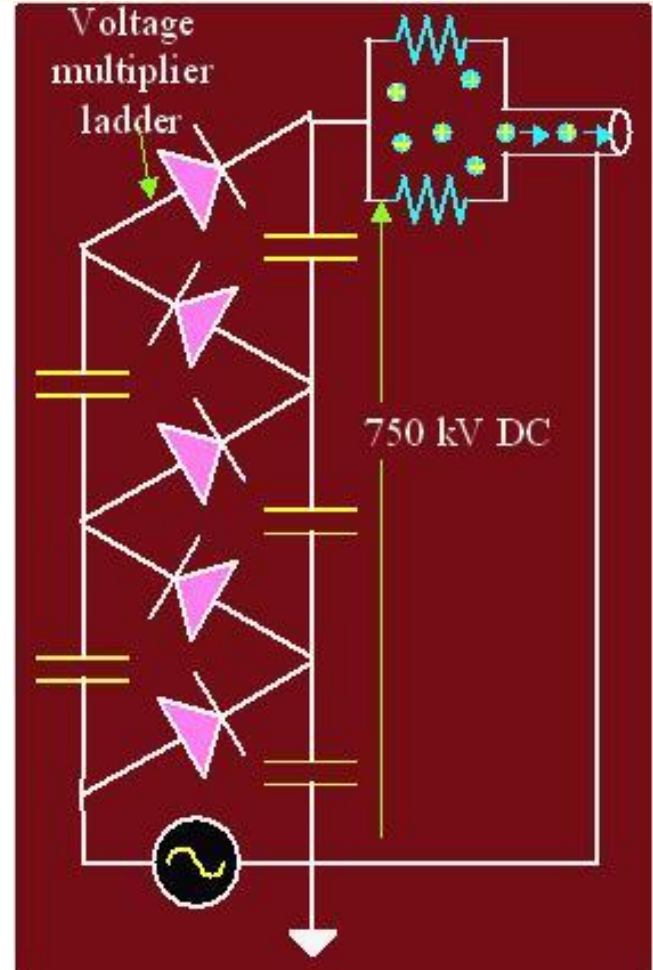

# Cockcroft & Walton

- Cockcroft and Walton in 1932 used this circuit design to power their particle accelerator, performing the first artificial nuclear disintegration in history. On '52 they got the Nobel Prize.
- It is interesting to remark that soon it found a technological use, for instance, for testing devices to be exposed to high electric fields; use that is still practiced.
- During the 30's Cockcroft- Walton accelerator has quickly had its time
- **REMARK:** The circuit was invented much earlier, in 1919, by Heinrich Greinacher, a Swiss physicist.

# Back to Thales: Van Der Graaf Accelerator

Ancient cultures around the Mediterranean knew that certain objects, such as rods of amber, could be rubbed with cat's fur to attract light objects like feathers. Thales of Miletus made a series of observations on static electricity around 600 BC.

In the eighteen century a number of devices were conceived and carried out which were able to produce very large difference of potential resorting to the same effect described by Thales.

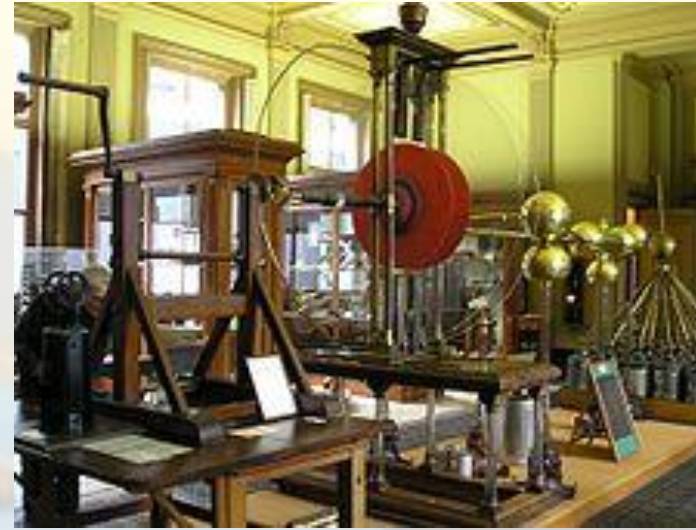

Martinus van Marum's (1784)  
Electrostatic generator at  
Teylers Museum (Nederland)

Last century, at the end of 20's **Van Der Graaf** at Princeton University built an electrostatic generator based on the phenomenon described by Thales, which got its name from the inventor. As an accelerator it was more long-lived than Cockcroft-Walton.



# Van der Graaf Generator

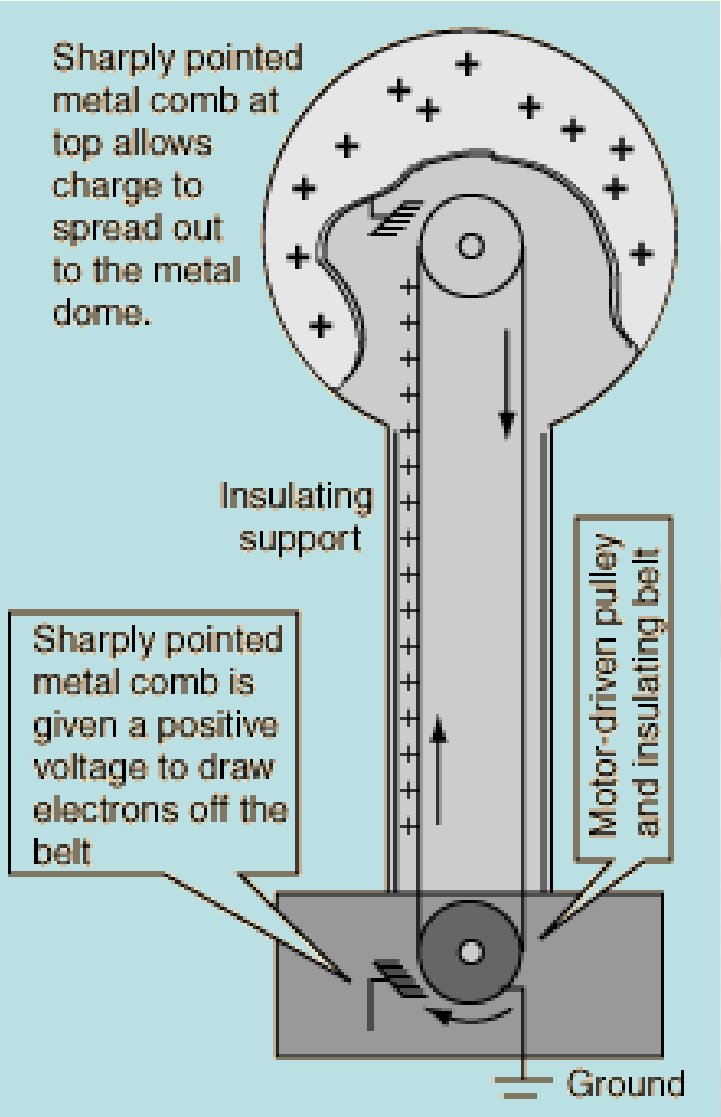

This system is simple and at the same time ingenious: the positive charge is "sprayed" at low potential (10kV) on the belt which drags it inside the sphere; here is neutralized by negative charges "sprayed" **As the belt continues to move, a constant 'charging current' travels via the belt, and the sphere continues to accumulate positive charge until the rate that charge is being lost (through leakage and corona discharges) equals the charging current.** The larger the sphere and the farther it is from ground, the higher will be its peak potential. A student of high school can try to build an accelerator. **The cost was \$90**

## Van de Graaff generator at The Magic House, St. Louis Children's Museum



Today it is still used as an accelerator to generate energetic particle and X-ray beams in fields such as nuclear medicine..



# A Van Der Graaf generator for class room demonstrations



13/01/2020

23

# Van Der Graaf Accelerator

- Many microamps of electrons can be accelerated by Van Der Graaf. Currently Van Der Graaf are commercial machines with potential ranging from one million to 25 MV (Mega Volt = million volts). By way of comparison, the short pulses used in research on lightning reach 10 MV and the potential in the clouds just before the lightning discharge is about 200 MV. The Van Der Graaf are often used in the analysis and modification of materials, especially in environmental research
- The need to investigate more and more profound aspects of matter behavior imposed to seek accelerators with increasing current intensity and larger and larger energy.

# Ernest Orlando Lawrence: Mr Cyclotron



In Berkeley **Ernest Orlando Lawrence** had raised the issue of meeting physicist needs of simple and relatively inexpensive research engine. He was a man of harsh frugality. He was used to not hesitate to fire his co-workers, as he did twice with R. Wilson, who later become director of Fermilab. He got the Nobel price for the invention of the cyclotron.

# The Cyclotro

- Physicists started requiring particles **energy comparable** to those of unstable nuclei used by Rutherford, but with **much higher intensity** and heavily collimated beams. Lawrence's goals were very ambitious: to generate intense beams of tens of MeV.
- While he was attending a conference in Berkeley, bored by presentations, went to the library and found Wideroe thesis . He watched just the drawings and formulas because he understood little or nothing of German.
- Resorting to linear accelerators concept would mean to add a large number of drift tubes. The solution cumbersome expensive and impractical.
- **He would rather conceive a device able to reconcile the circular trajectories and synchronous acceleration.**



# The Cyclotron

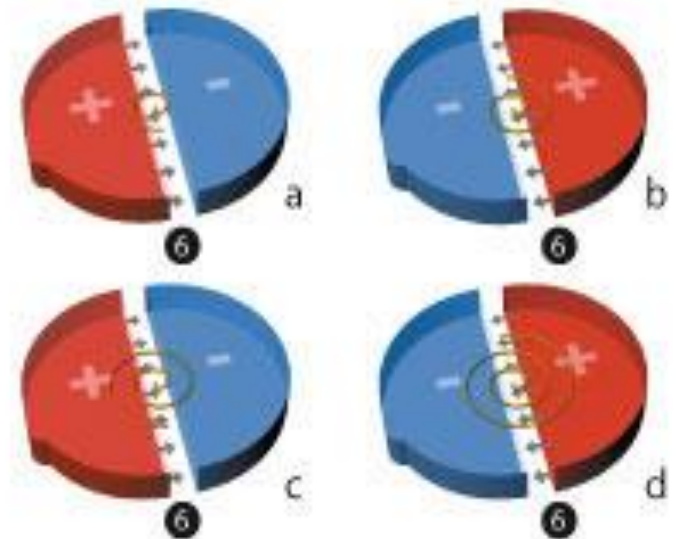
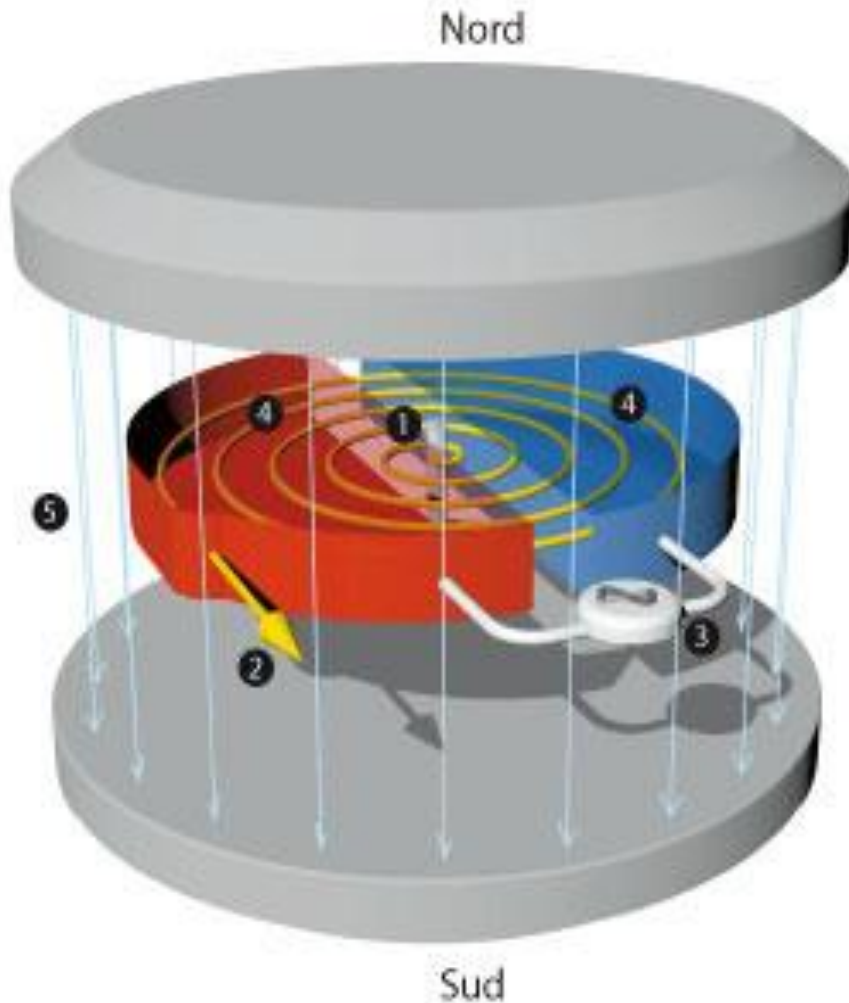

1. Positive ions source
2. Positive ions beam
3. RF power generator
4. D shaped electrodes (Dee's)
5. Magnetic Field
6. Electric Field

# The Cyclotron

- Therefore, there was need of a magnet which would bend the trajectory of the beam. As accelerating electrodes, he devised a structure formed by the two halves of a very flattened conductive cylinder (pillbox): one half was connected to ground and the other to an RF generator.
- The charged particles, accelerated after each crossing through the gap between the electrodes, travel along the half circumferences of increasing radius. Nevertheless, their angular velocity stay constant.

Lawrence noticed that ions of rest mass  $m_0$  and charge  $e$  moving in a uniform magnetic field  $B$  circulate at a constant frequency independent of energy:

$$f = 2\pi eB / m_0 c$$

From then on it was named **cyclotron frequency**. RF feeder must have the same frequency.

# The Cyclotron

The cyclotron was built by Lawrence in collaboration with his student Milton Stanley Livingston. After some unsuccessful tests, Livingstone insisted to apply some changes that, according to his thought, could solve the issue. Lawrence disagreed and did not give his consent. Profiting of Lawrence temporary leave, Livingstone applied the changes and they resulted in a successful test. It was 1932. Livingston declared: "When I built the cyclotron, Lawrence received the Nobel prize and I got the title of Doctor of Philosophy ...".



# Cyclotron's limits

$$\omega = \frac{eB}{\gamma m_0 c}$$

- The researchers began building cyclotrons increasingly large and increasingly higher performance. However, for relativistic energies, some limitations appeared. **The cyclotron frequency decreases with the increment of the relativistic mass; this effect causes the loss of synchronism between the bunch gap crossing and the phase of the RF power:**
- By means of spiral shaping of the Dees one can introduce a compensating correction to the RF phase delay. However, that remedy can work only to some extent (in terms of energy).
- decreasing the frequency of the generator (Synchrocyclotron). However, apart for energy limitation, this solution can accelerate only one bunch and the next one can be accelerated only when the last has been ejected.

# Cyclotron's limits

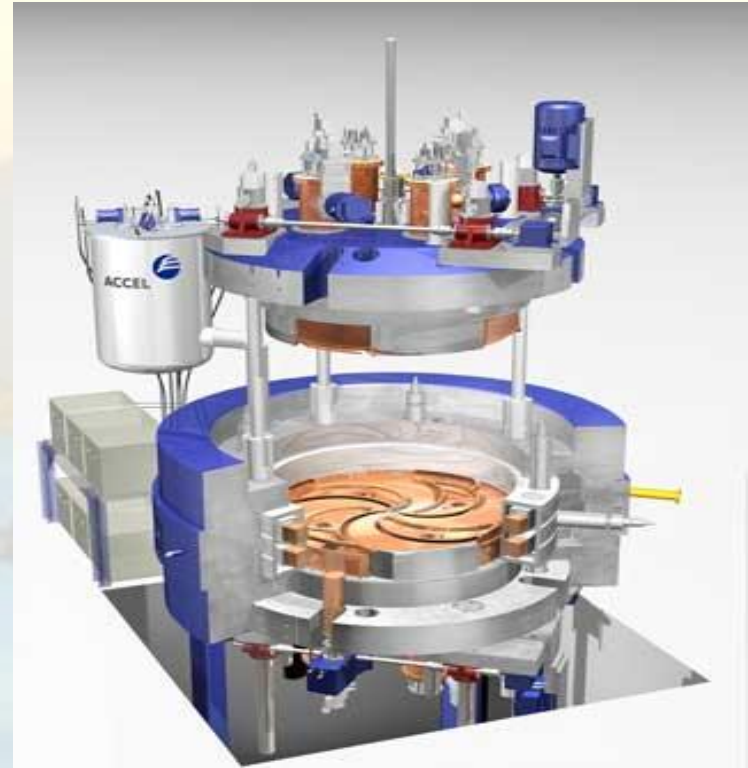
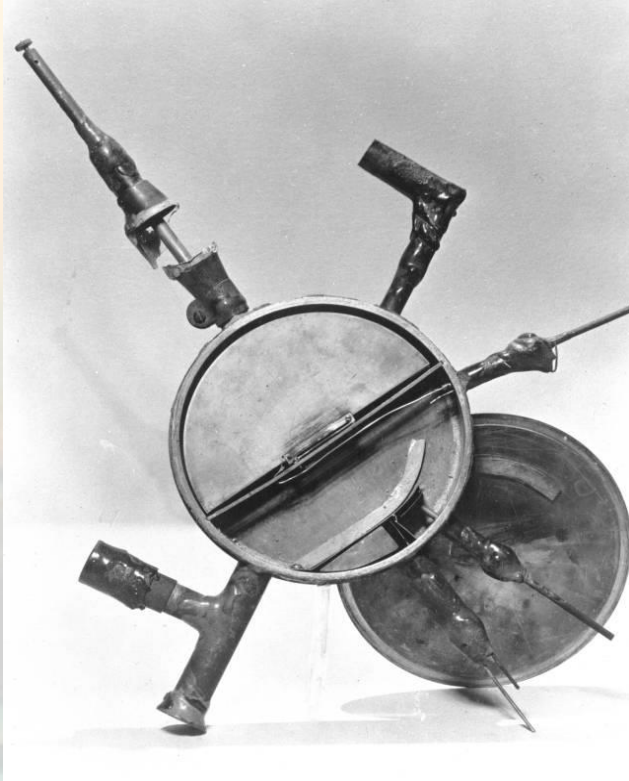

The cyclotron continues to be used for its versatility, simplicity and robustness. It is not a Ferrari but an overpowering bulldozer! It has a very wide range application in fields such as cancer treatment and the production of radionuclides employed in diagnostic imaging.

# The Guinness Record Cyclotron at Gatchina, Russia

Its weight exceeds of 25% the weight of Eiffel Tower (10,100 tons)!



# What we have learned

Exploring the infinitely small requires more and more energetic projectiles. This may be done only with charged particles beams with quite demanding features: strong collimation; high intensity; high energy.

1. Horizontal focusing competes with the vertical one: weak focusing
2. DC accelerators suffer limitation in energy and current.
3. Cyclotrons are limited in energy
4. Synchronization and focusing are important issues to overcome.

# The new generation: the Synchrotron

In order to meet the new requirements a new generation of accelerators: the synchrotrons. The principle is to keep separated the bending and focusing devices (magnets of various types) from the ones that accelerates (resonant cavities). There is main difference from cyclotrons: **the particles always ride on the same orbit**. Therefore:

- the cavities field must be synchronous with particle crossing (**see Wideroe linac**)
- the bending magnet field must change in order to keep constant the radius of curvature.



# The 1<sup>st</sup> synchrotron: the Cosmotron

<http://www.lns.cornell.edu/~dugan/USPAS/>

- The basic principles of synchrotron design (**phase stability principle**) were proposed independently by **Vladimir Veksler** in the Soviet Union (1944) and **Edwin McMillan** in the United States (1945). According to this principle, it is possible to accelerate bunches of charged particles of finite dimensions. **Those dimensions are as smaller as higher is the acceleration.**



13/01/2020

<http://www.lns.cornell.edu/~dugan/USPAS/>

35



# The phase stability principle

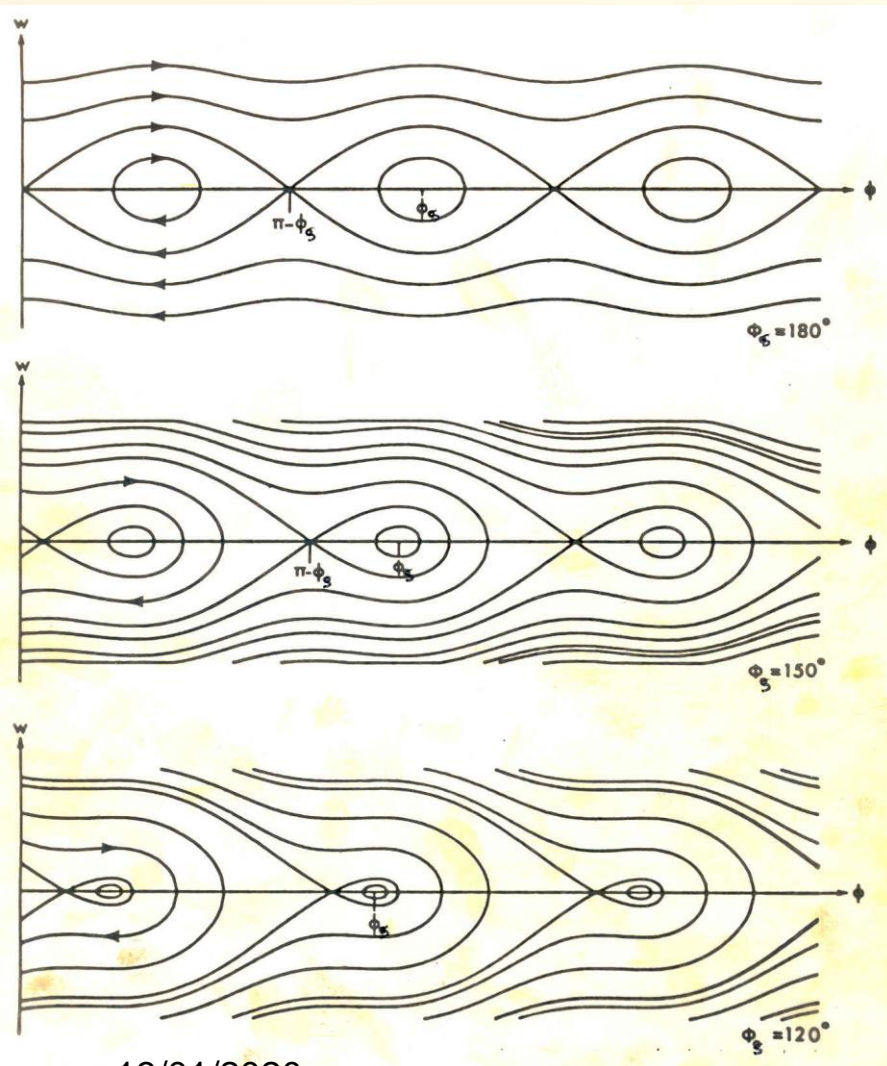

The areas of stable motion (closed trajectories) are called “BUCKET”. As the synchronous phase gets closer to  $90^\circ$  the buckets get smaller. The number of circulating buckets is equal to  $2\pi f / \omega$  ( $f = \text{radio frequency}$  ;  $\omega = \text{particle angular frequency}$ ). The phase extension of the bucket is maximum for  $\phi_s = 180^\circ$  (or  $0^\circ$ ) which correspond to no acceleration. The RF acceptance (Capture) increases with the RF voltage.

# A glance to the future: the great leap forward

Since when Brookhaven's Cosmotron went into operation in the early 1950's, scientists were already aware that **achieving the higher energies needed for future research was going to be a difficult problem**. Calculations showed that, using existing technology, building a proton accelerator **10 times more powerful** than the 3.3GeV Cosmotron would require **100 times as much steel**. Such a machine would weigh an astronomical 200,000 tons.

# the great leap forward: the strong focusing

While the first synchrotrons and storage rings strictly used the toroid shape, **the strong focusing principle** independently discovered by Ernest Courant and Nicholas Christofilos allowed the complete separation of the accelerator into components with specialized functions along the particle path, shaping the path into a round-cornered polygon. Some important components are given by radio frequency cavities for direct acceleration, dipole magnets (bending magnets) for deflection of particles (to close the path), and quadrupole / sextupole magnets for beam focusing.

# the great leap forward: the strong focusing

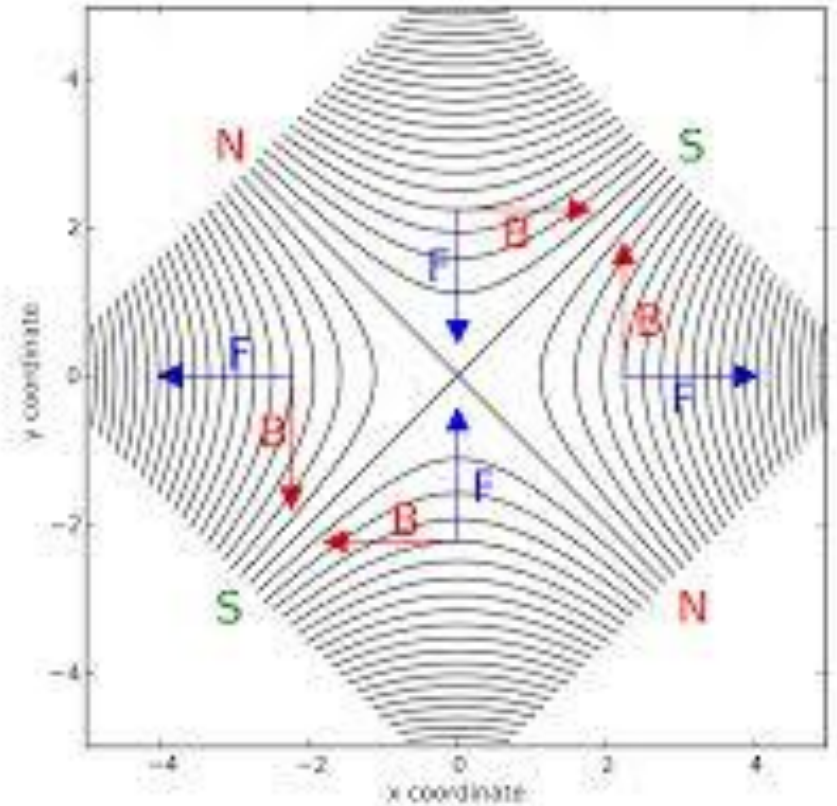



# the great leap forward: the strong focusing

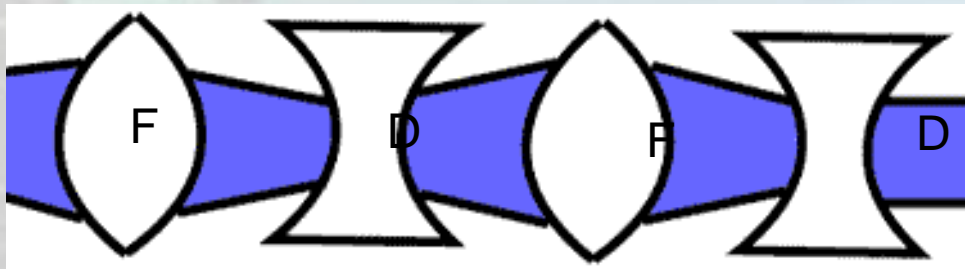
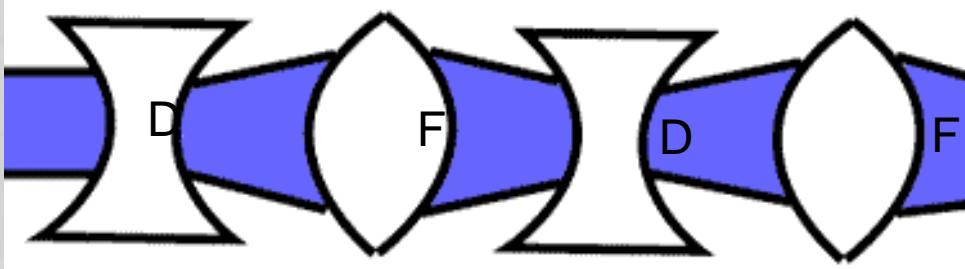
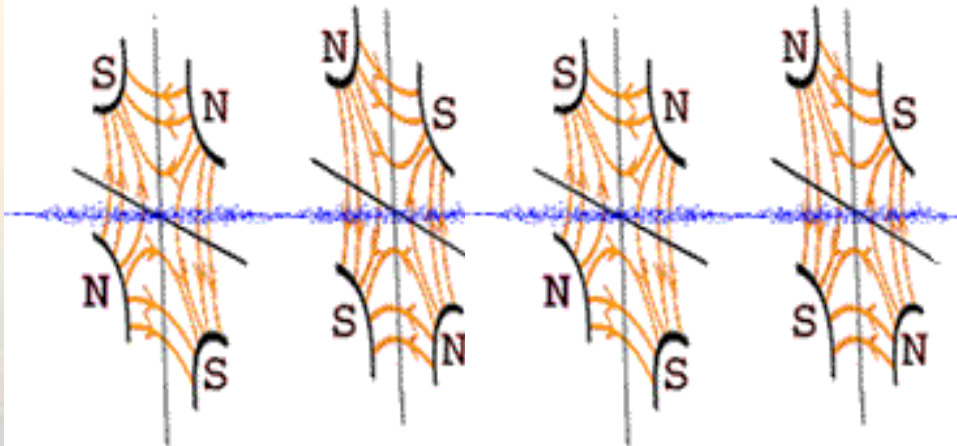

$$\frac{1}{f} = \frac{1}{f_1} + \frac{1}{f_2} - \frac{\Delta}{f_1 f_2}$$

if  $f_1 = -f_2$   
and  $\Delta = |f_1|$

$$\frac{1}{f} = \frac{1}{|f_1|}$$

H

Alternating the focusing and defocusing actions produces focusing in both planes.

V



# AGS

Alternating Gradient Synchrotron  
33 GeV on July 29, 1960



# The Already 'Passed by' Future

Even before the successful achievements of AGS, the scientific community was aware of another step needed to revolution the accelerator techniques. Indeed, the impact of particles against fixed targets is very inefficient from the point of view of the energy actually available to create new particles: much more effective could be the head on collisions between high-energy particles.

## BUT THERE IS A REAL NEED OF COLLIDERS

- With increasing energy, the energy available in the centre of mass with fixed targets is incomparably smaller than in the head-on collision, as Wideroe thought some decades before. That is, if we want the same energy in the centre of mass, using fixed targets one should build gigantic accelerators that no Country or supranational organization could afford. By resorting to relativistic dynamics, for the energy and for the accelerator circumference one gets:

$$E_{FT} = 2\gamma_{LHC} E_{LHC} \cong 15 \times 10^3 E_{LHC}$$
$$C_{FT} \cong 15 \times 10^3 C_{LHC} = 405,000 \text{ km}$$

- The price to pay consists in producing **high collimated beams** in order to increase the luminosity

# Rolf Wideroe and Bruno Touschek

- Rolf Wideroe was a volcanic mind: in scientific circles he is credited of inventing the betatron, synchrotron, linear accelerator, the storage rings for colliding beams. The latter invention pioneered about 20 years the realization that as we will see later was carried out in Italy at the laboratories of Frascati
- Hamburg 1943. Wideroe meets Bruno Tuschek. The imprisonment of Touschek by the Nazis.
- The "todenstrahl" (death ray). The imprisonment of Wideroe by Allied Forces



# Rolf Wideroe and Bruno Touschek

- Touschek was arrested by the Gestapo in 1945, Widerøe visited him in prison, and during these meetings they continued to discuss about the betatron. In particular, Touschek conceived the idea of radiation damping for electrons circulating in a betatron.<sup>[1]</sup>



# Rolf Wideroe and Bruno Touschek

Incidentally, in that context Touschek conceived the idea of radiation damping for electrons. When the Allied army reached Hamburg Wideroe, suspected of collaboration, was arrested. Sometime after, he was found not guilty and released. After the war, Touschek roamed about Europe. Finally, in 1952 he decided to stay in Rome permanently, receiving the position of researcher at the National laboratories of the Istituto Nazionale di Fisica Nucleare in Frascati, near Rome.

# The Contest: Frascati vs Princeton

- A contest between Princeton and the Frascati Laboratories started. Princeton chose a eight-shaped structure: two circular rings in which electrons and positron were circulating with the same orientation, meeting at the collision point. Frascati was even more audacious: they used a single ring with "counter-rotating" beams of electrons and positrons. Although it started for last, it came first: it was 1960, when the era of the colliders has begun. This success had great prominence internationally..

# The Contest: Frascati vs Princeton

The enterprise began March 7, 1960. When Bruno Touschek held a seminar at Frascati Laboratories where he proposed to build an electron-positron storage ring. According to Wideroe's visionary ideas concerning storage rings and colliders, on March 14, a preliminary study demonstrated the feasibility of the proposal. The storage ring was called ADA ( Anello Di Accumulazione = storage ring).

The total cost of the project was around 4000 € at present currency.

# THE COLLIDER HERA BEGINS

A page from Touschek's notebook

ADA

18-2-60

State of affairs - Discussed plan with  
Griso - Decided for "subtle" storage  
& proposed use of  $\gamma$ -beam also  
for electrons  
Typical possibility:

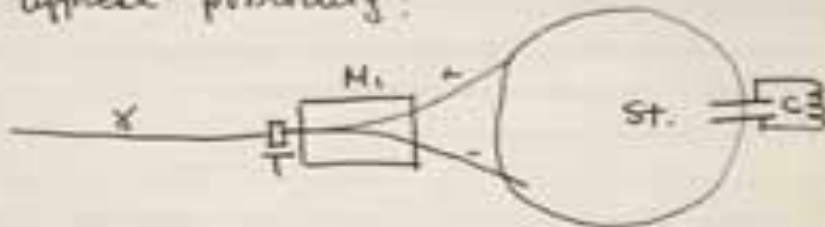

$\gamma$  =  $\gamma$ -beam, T = target, H<sub>1</sub> = separating magnet, St. = Storage magnet, C = Arc circuit.

Basic formula

$$q = N^2 (v\tau)^2 \frac{\sigma}{q} \cdot \frac{c}{\pi R}$$

N = number of particles accepted per pulse  
v = repetition rate of the Synch (v = 10)



# Beware

- Needs: beams with much larger intensity, much smaller energy spread , higher and higher collimation.
- Early '60s: MURA 50 MeV ( as well as other accelerators) exhibited instabilities consisting in a coherent self bunching and vertical coherent oscillation during particle storing. The phenomenon seemed to be related to the amount of current stored. The accumulated current could not go beyond a certain limit. Above this threshold there was evidence of coherent instabilities leading to beam loss. These were interpreted as due to the presence of some special equipment inside the vacuum tank (clearing electrodes).



# Beam-equipment e-m interaction and Dynamics: the Flow Chart (circular accelerators)

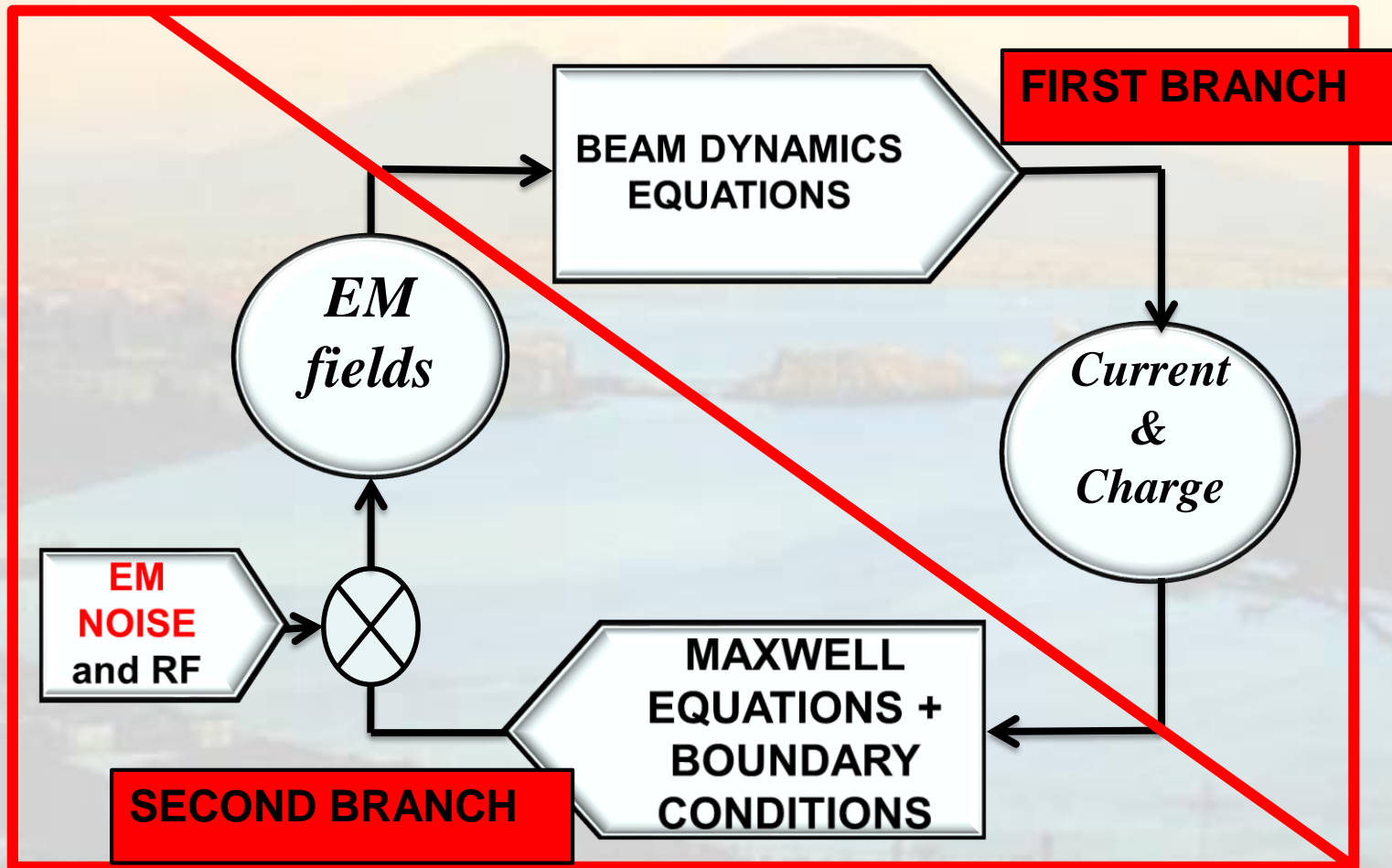



- TOUSCHEK
- Not just a scientist...



Thank you, and keep up the good work



13/01/2020

53

## Instabilities for Freshers

Likewise many modulational instabilities, the present one is triggered by the electric field noise  $\Delta E_0(\omega)$ , that will act as the initial input of the beam dynamics equation. The process is continuous, but one may represent it stepwise, turn by turn. Let us introduce integrated value over one turn

$$\Delta V_0(\omega) = \langle 2\pi R \Delta E_0(\omega) \rangle$$

defined as input voltage. One may define the following transfer functions (input-output) in the frequency domain:  $Y_D(\omega)$  for the beam dynamics branch and  $Z_{EM}(\omega)$  for the electromagnetic branch.

## Instabilities for Freshers

**1<sup>st</sup> turn.** Therefore, the perturbed current in the beam will be represented as:

$$\Delta I_1(\omega) = Y_D(\omega)\Delta V_0(\omega)$$

The perturbed current, acting as input to Maxwell's equations (namely interacting with the surrounding medium via electromagnetic fields),  $(\omega)$  will produce after one turn a perturbed voltage  $\Delta V_1$

$$\Delta V_1(\omega) = Z_{EM}(\omega)\Delta I_1(\omega) = Z_{EM}(\omega)Y_D(\omega)\Delta V_0(\omega)$$

**2<sup>nd</sup> turn** This voltage will produce a new perturbed current via the dynamics equation, given by the formula:

$$\Delta I_2' = Y_D(\omega)\Delta V_1(\omega) \equiv Y_D(\omega)Z_{EM}Y_D\Delta V_0$$



## Instabilities for Freshers

Therefore, the **total** perturbed current will be the sum of the new one and of the perturbed previous currents. This last one is affected by the factor  $\alpha$ , which takes into account the **possible damping** of the perturbation

$$\Delta I_2'' = \alpha \Delta I_1$$

The total perturbed current is:

$$\Delta I_2 = \Delta I_2'' + \Delta I_2' = \alpha \Delta I_1 + Y_D Z_{EM} \Delta I_1 = [\alpha + Y_D Z_{EM}] Y_D \Delta V_0$$

$n^{\text{th}}$  turn, we have:

$$\Delta I_n = \{\alpha + Z_{EM} Y_D\}^{n-1} Y_D \Delta V_0$$

# Instabilities for Freshers

It is apparent that the condition of stability is

$$\{\alpha + Z_{EM}Y_D\} < 1$$

Or else

$$Z_{EM} < (1 - \alpha)/Y_D$$

Conclusions. Recipes to reach stability and/or increase the stability margin:

1. Minimize  $\alpha$
2. Minimize  $Z_{EM}$
3. Minimize  $Y_D$

# Beam-equipment e-m interaction and Dynamics: the Flow Chart (circular accelerators)

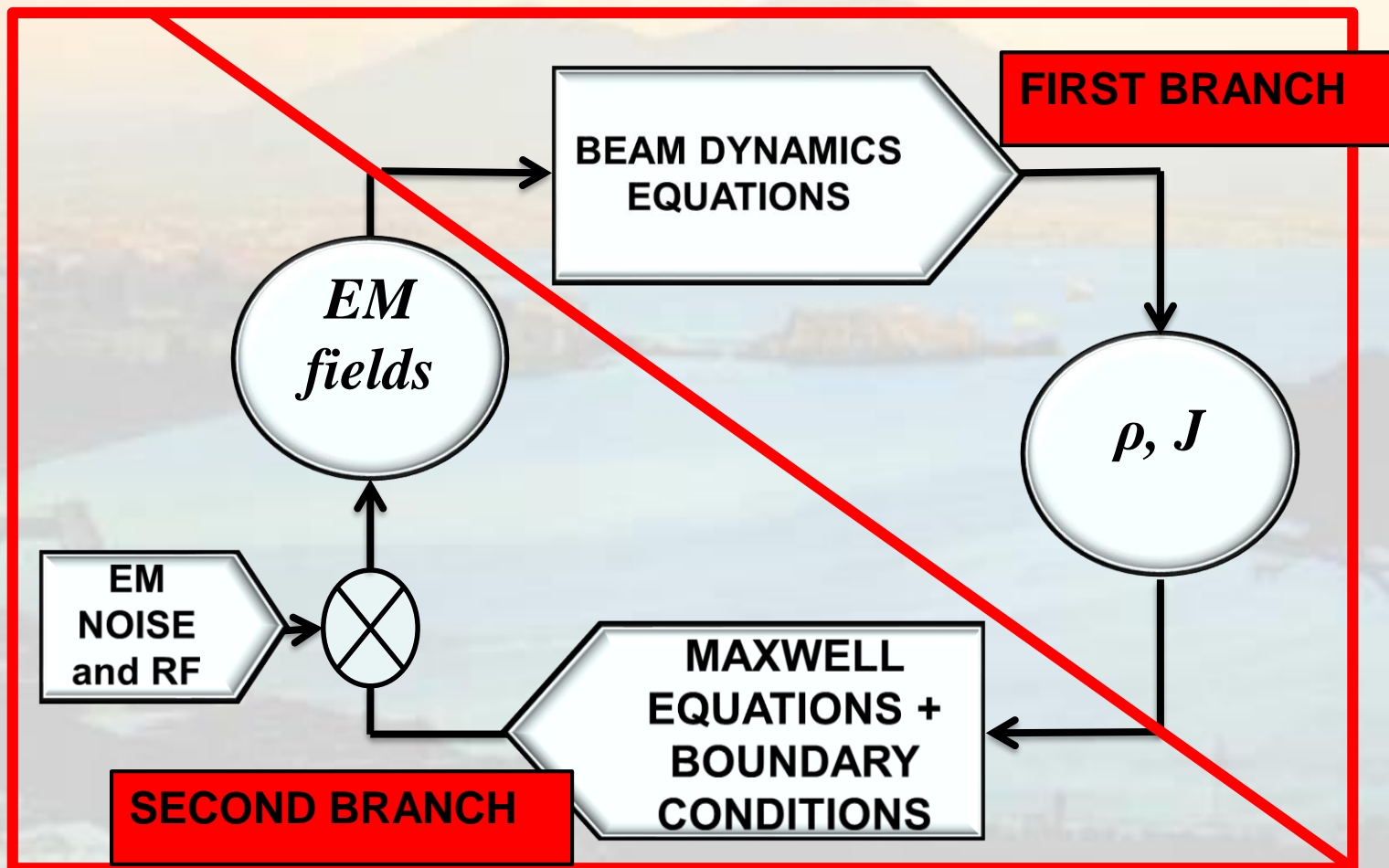

## Instabilities for Freshers

Likewise many modulational instabilities, the present one is triggered by the electric field noise  $\Delta E_0(\omega)$ , that will act as the initial input of the beam dynamics equation. The process is continuous, but one may represent it stepwise, turn by turn. Let us introduce integrated value over one turn

$$\Delta V_0(\omega) = \langle 2\pi R \Delta E_0(\omega) \rangle$$

defined as input voltage. One may define the following transfer functions (input-output) in the frequency domain:  $Y_D(\omega)$  for the beam dynamics branch and  $Z_{EM}(\omega)$  for the electromagnetic branch.

## Instabilities for Freshers

**1<sup>st</sup> turn.** Therefore, a the perturbed current in the beam will be represented as:

$$\Delta I_1 = Y_D \Delta V_0$$

The perturbed current, acting as input to Maxwell's equations (namely interacting with the surrounding medium via electromagnetic fields), will produce after one turn a perturbed voltage  $\Delta V_1$

$$\Delta V_1(\omega) = Z_{EM} \Delta I_1 = Z_{EM} Y_D \Delta V_0$$

**2<sup>nd</sup> turn** This voltage will produce a new perturbed current via the dynamics equation, given by the formula:

$$\Delta I'_2 = Y_D \Delta V_1 \equiv Y_D Z_{EM} Y_D \Delta V_0$$



## Instabilities for Freshers

Therefore, the **total** perturbed current will be the sum of the new one and of the perturbed previous currents. This last one is affected by the factor  $\alpha$ , which takes into account the **possible damping** of the perturbation

$$\Delta I_2'' = \alpha \Delta I_1$$

The total perturbed current is:

$$\Delta I_2 = \Delta I_2'' + \Delta I_2' = \alpha \Delta I_1 + Y_D Z_{EM} \Delta I_1 = [\alpha + Y_D Z_{EM}] Y_D \Delta V_0$$

$n^{\text{th}}$  turn, we have:

$$\Delta I_n = \{\alpha + Z_{EM} Y_D\}^{n-1} Y_D \Delta V_0$$

# Instabilities for Freshers

It is apparent that the condition of stability is

$$\{\alpha + Z_{EM}Y_D\} < 1$$

Or else

$$Z_{EM} < (1 - \alpha)/Y_D$$

Conclusions. Recipes to reach stability and/or increase the stability margin:

1. Minimize  $\alpha$
2. Minimize  $Z_{EM}$
3. Minimize  $Y_D$



ISR-RF/66-35

November 18, 1966

LONGITUDINAL INSTABILITY OF A COASTING BEAM ABOVE TRANSITION, DUE TO  
THE ACTION OF LUMPED DISCONTINUITIES.

by V.G. Vaccaro

1. Generalities

We assume that the electrical action on an ion beam, of a discontinuity in a tank is that of an impedance. We still consider the case in which this discontinuity is sufficiently small compared with the wavelength of the perturbation, to be considered as concentrated.

# WIDEROE tells about us E. O. Lawrence

- At this point let us give the floor to Wideroe that, much later, met Lawrence who told him about how he conceived the cyclotron: "Lawrence, once told me that while attending a conference in Berkeley, bored by presentations, went to the library and found my thesis in the journal Archiv für Elektrotechnik. He watched just the drawings and formulas because he understood little or nothing of German. "

In 1969, when Wilson was in the hot seat testifying before the Congressional Joint Committee on Atomic Energy, Sen. John Pastore demanded to know how a multimillion-dollar particle accelerator (the Fermilab accelerator) improved the security of the Country.

Senator: "Is there anything connected with the hopes of this accelerator that in anyway involves the security of the Country?"

Wilson: "No, Sir. I don't believe so."

Senator: "Nothing at all?"

Wilson: "Nothing at all."

Senator: "It has no value in that respect?"

Wilson: "It has only to do with the respect with which we regard one another, the dignity of man, our love of culture. It has to do with: Are we good painters, good sculptors, great poets? I mean all the things we really venerate in our Country and are patriotic about. **It has nothing to do directly with defending our Country except to make it worth defending.**"



# Instabilities for pedestrians **gedanken experiment**

- Only afterwards, with the development of powerful microwave generators such those used for Second War radars, the idea of linear accelerators for both for electrons to protons was revived and extensively developed. This solution is still very up to date, and has witnessed impressive achievements: the Stanford Linear Accelerator, 3 km long, in 1966 accelerated electrons to 20 GeV and electrons and positrons to 50 GeV in 1989.

$$\Delta V_1'(\Omega) = Z_M(\Omega) \Delta I(\Omega)$$

$$\Delta V_1'(\Omega) = Z_M(\Omega) Y_B(\Omega) \Delta V(\Omega)$$

This voltage now acts back again on the beam, producing an additional perturbation, and so on. After  $m$  turns we have:

$$\Delta V_m'(\Omega) = [Z_M(\Omega) Y_B(\Omega)]^m \Delta V(\Omega)$$