

# Vacuum Systems

## Lecture 3

V. Baglin

CERN TE-VSC, Geneva



# Outline

1. Cryopumping
2. Adsorption isotherms
3. Cryosorber in cold systems: case of LHC
4. Helium leaks in cold systems: case of LHC

# 1. Cryopumping

# Desorption probability

- The desorption probability,  $p$ , is a function of the **binding energy**,  $E$  and the **temperature**,  $T$  (first order desorption, Frenkel 1924). The surface coverage,  $\theta$ , varies like :

$$p = \frac{d\theta}{dt} = -\theta \nu_0 e^{-\frac{E}{kT}}$$

( $\nu_0 \sim 10^{13}$  Hz,  $k = 86.17 \cdot 10^{-6}$  eV/K)

- The desorption process is characterized by the **sojourn time**,  $\tau$  :

$$\tau = \frac{e^{\frac{E}{kT}}}{\nu_0}$$

- For large  $E$  and small  $T$ , the molecule remains onto the surface : **CRYOPUMPING**
- For some combination of  $E$  and  $T$ , the molecule is desorbed (bake out)

# Sojourn time at cryogenic temperature

- Cryosorption occurs till ~ 100 k

E(eV)	1.9 K	4.2 K	50 K	70 K
0.01	1 10 <sup>6</sup> years	0.1 s	1 ps	0.5 ps
0.02	∞	3 10 <sup>3</sup> years	10 ps	2 ps
0.15	∞	∞	130 s	6 ms
0.21	∞	∞	5 years	130 s
0.3	∞	∞	1 10 <sup>4</sup> years	12 years

$$\tau = \frac{e^{\frac{E}{kT}}}{V_0}$$

# Sojourn time - Physisorbed molecules

- Physisorption occurs:
  - below 20 K for binding energies  $< 0.1$  eV
  - below 50 K for binding energies  $< 0.2$  eV
  - below 70 K for binding energies  $< 0.3$  eV

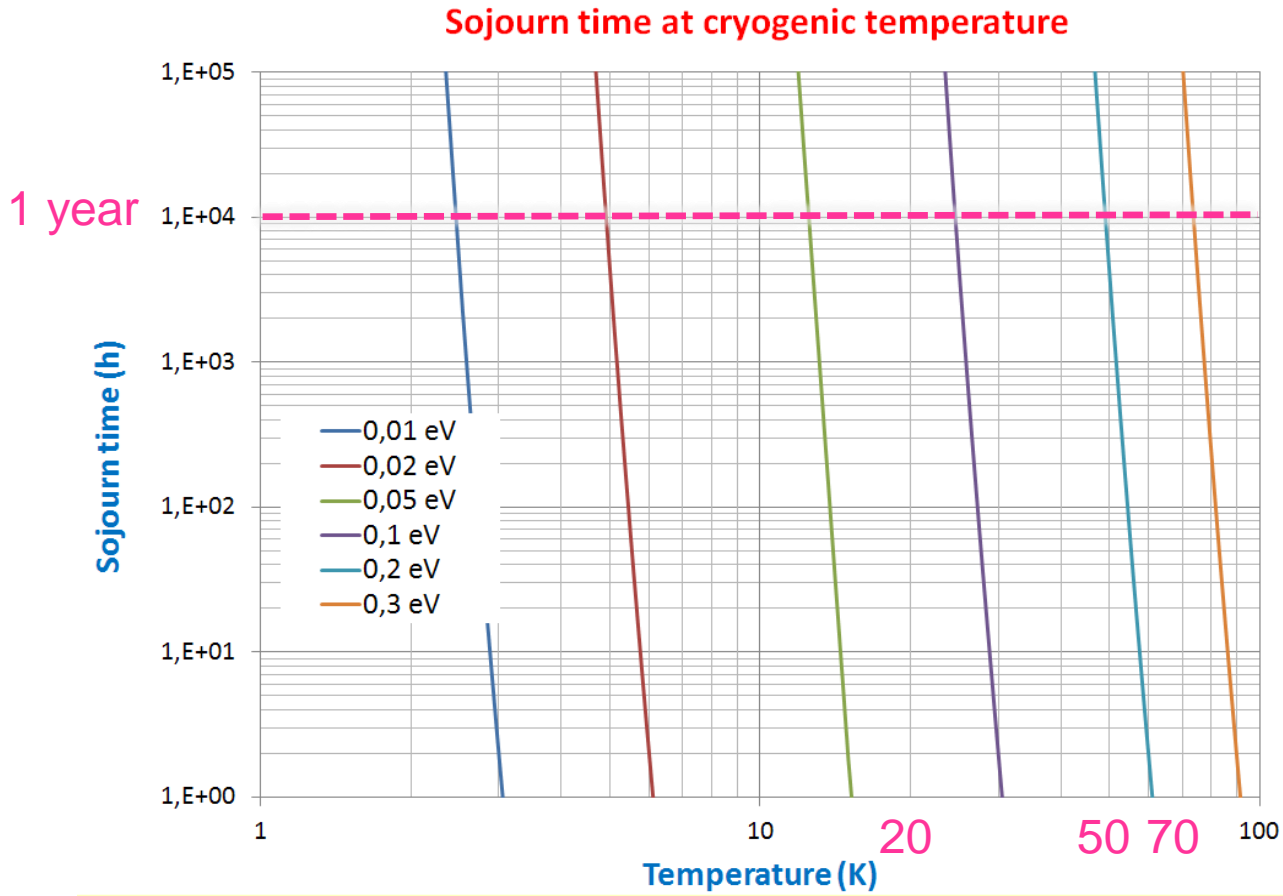

# A Natural Warm Up of a St. Steel Cold Bore

COLDEX #14 19-25/3/99,  
Cu BS. Natural warm up of CB at 2.2 K/h (TBS>20 a 50 K)

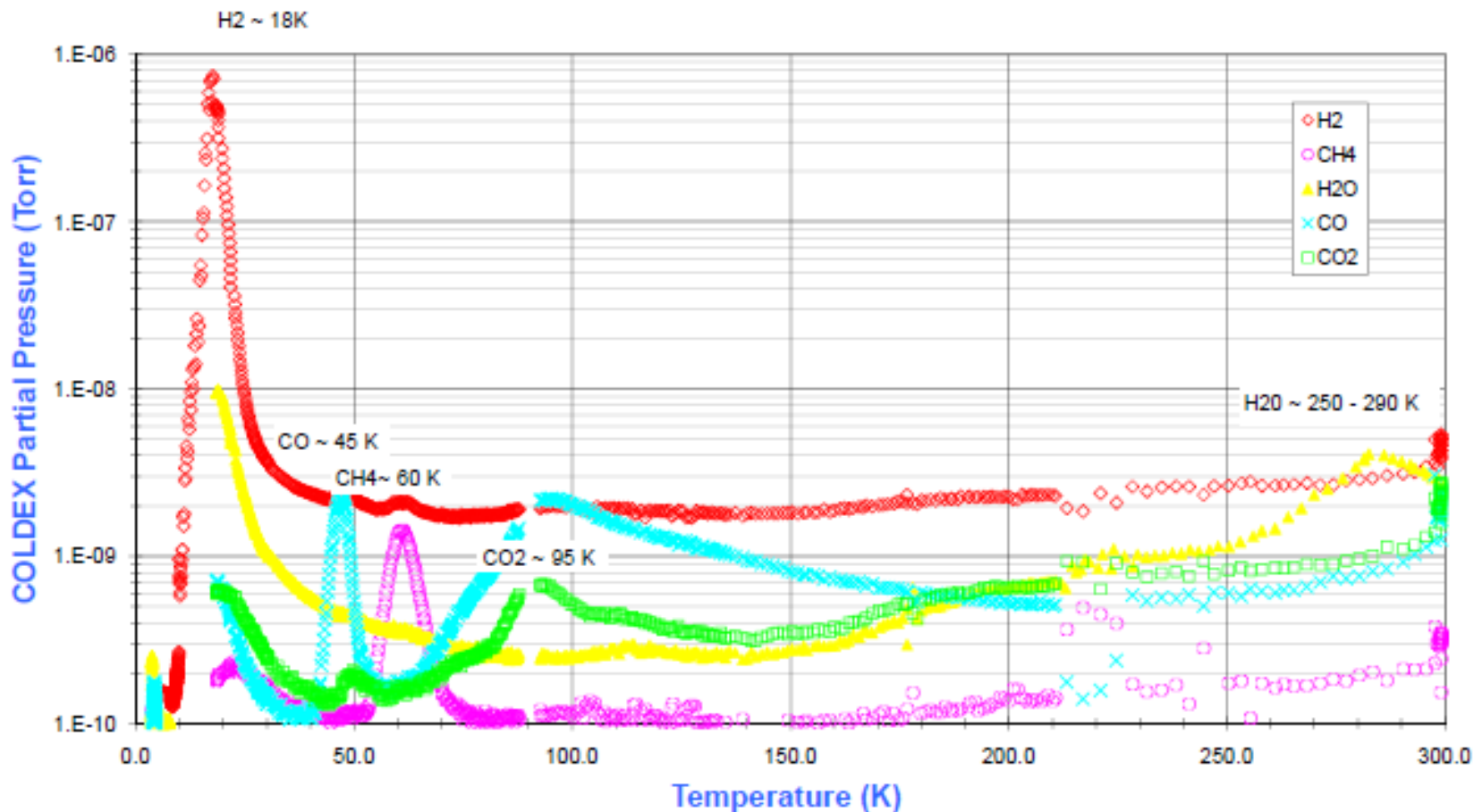



# Cryopumping regimes

## Physisorption

- **Sub-monolayer** coverage : attractive force (van der Waals) between a gas molecules and a material
- Binding energy for physical adsorption
- $H_2$  from 20 to 85 meV for smooth and porous materials resp.
- 1 h sojourn time at 5.2 K and 26 K for smooth and porous materials resp.

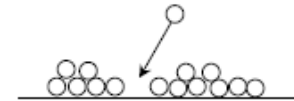

## Condensation

- For **thick gas coverage**, only forces between gas molecules
  - Energy of vaporisation 9 to 175 meV for  $H_2$  and  $CO_2$  resp.
  - 1 h sojourn time at 2.8 K and 53.4 K for  $H_2$  and  $CO_2$  resp.
- sub-monolayers quantities of gas can be *physisorbed* at their boiling temperature (ex :  $H_2$  boils at 20.3 K and a bake-out above 100 °C removes water)

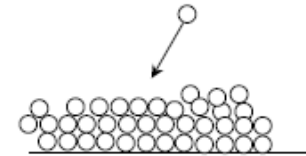

## Cryotrapping

- Use of a easily condensable carrier (e.g. Ar) to trap molecules with a high vapor pressure gas (e.g. He,  $H_2$ )

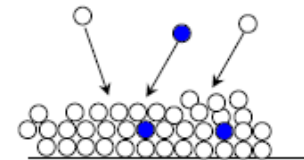

# Sticking probability/coefficient

- Probability :  $0 < \sigma < 1$

$\nu$  collision rate (molecules.s<sup>-1</sup>.cm<sup>-2</sup>)

$$\sigma = \frac{V_{\text{incident}} - V_{\text{departing}}}{V_{\text{incident}}} = \frac{V_{\text{sticking}}}{V_{\text{incident}}}$$

- Function of gas, surface, surface coverage, temperature of gas and surface temperature

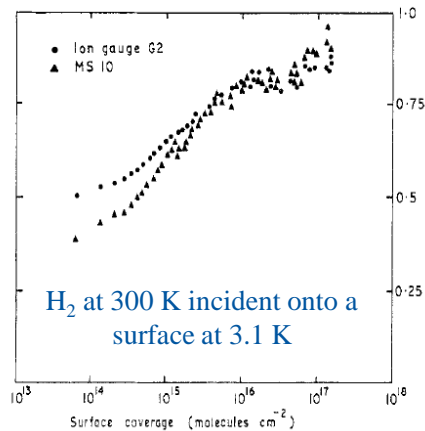

J.N. Chubb *et al.* J. Phys. D, 1968, vol 1, 361

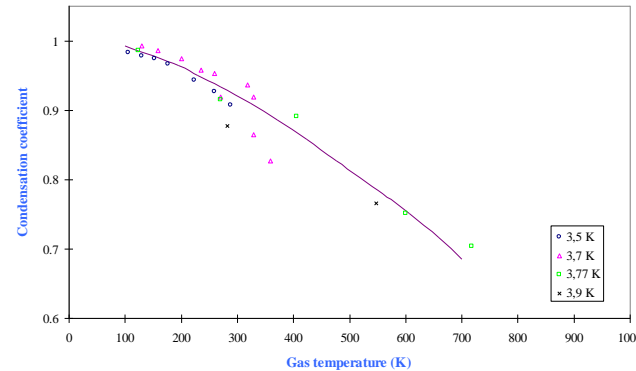

J.N. Chubb *et al.* Vacuum/vol 15/number 10/491-496

- Pumping speed

$$S = \frac{1}{4} \sigma \left( 1 - \frac{P}{P_{\text{sat}}} \right) A \bar{\nu} \approx \frac{1}{4} \sigma A \bar{\nu}$$

$$S [\text{l.s}^{-1}.\text{cm}^{-2}] = 3.63 \sigma \sqrt{\frac{T}{M}}$$

*i.e.* :  $\sigma$  multiplied by the conductance of a surface

- H<sub>2</sub> and CO at 4.2 K :  
 $S_{\text{H}_2} = 5.3 \text{ l.s}^{-1}.\text{cm}^{-2}$   
 $S_{\text{CO}} = 1.4 \text{ l.s}^{-1}.\text{cm}^{-2}$

# Capture factor, $C_f$

- The capture factor takes into account the geometry of the system :

## Baffle in a cryopump

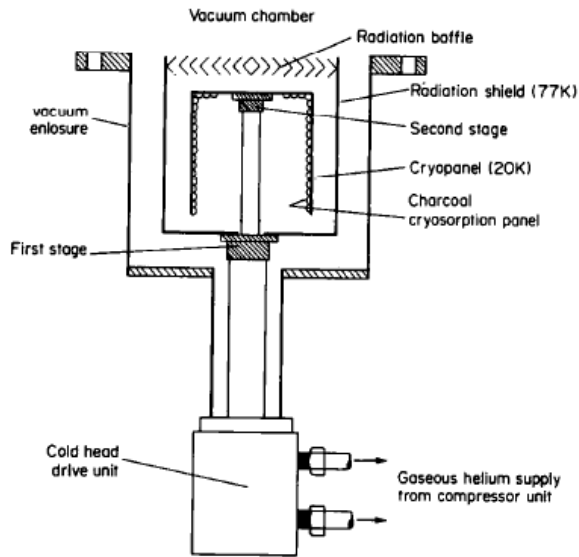

$$C_f \sim 0.3$$

R. Haefer. J. Phys. E : Sci. Instrum., Vol 14, 1981, 273-288

## Holes in the electron shield of the LHC beam screen

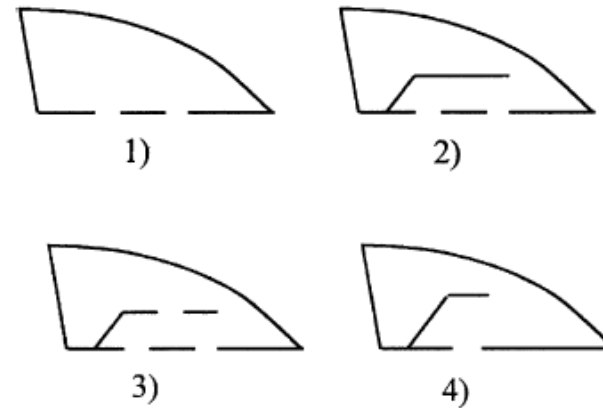

Fig. (1) Two slots in the beam screen, without electron shield, (2) two slots in the beam screen, electron shield without slot, (3) two slots in the beam screen, electron shield with slot, (4) only one slot in the beam screen, electron shield without slot.

$\sigma$	1	2	3	4
0.1	0.48	0.26	0.39	0.43
1	0.68	0.36	0.51	0.57

A.A. Krasnov. Vacuum 73 (2004) 195-199

# Thermal transpiration

- What is the pressure (gas density) in my cryogenic tube?
  - Vacuum gauges are usually located at room temperature to reduce heat load
- For small aperture, the collision rate,  $\nu$ , is conserved at the cold / warm transition

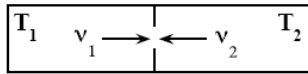

$$\nu = \frac{1}{4} n \bar{v}$$

- Since the average velocity scales like  $\sqrt{T}$

$$\frac{P_1}{P_2} = \sqrt{\frac{T_1}{T_2}}$$

$$\frac{n_1}{n_2} = \sqrt{\frac{T_2}{T_1}}$$

- In practice:

$T_1$ (K) = 300 K	$T_2$ (K)	4.2	77
	$P_1/P_2$	8	2

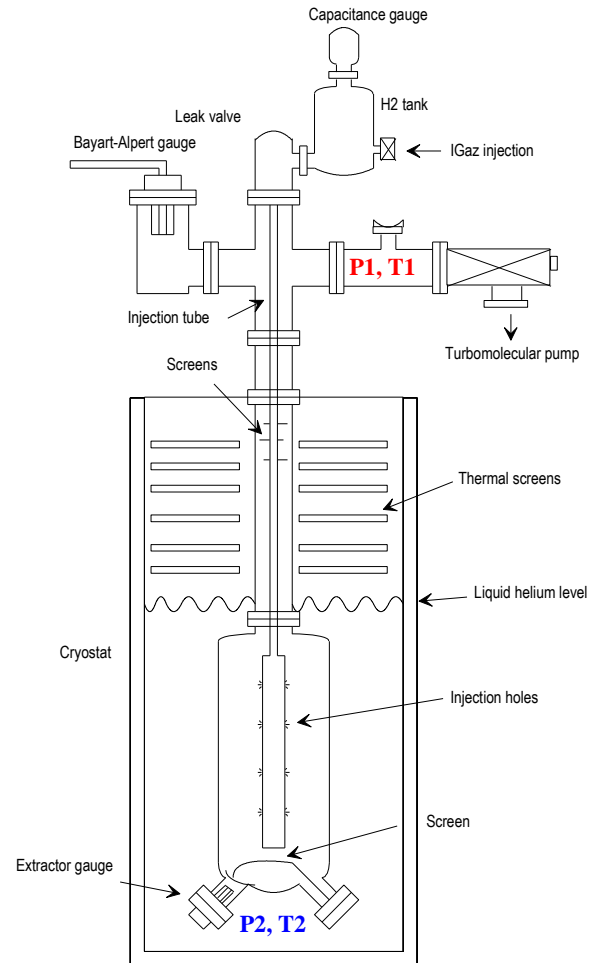

# Experimental evidence of thermal transpiration

## Static conditions

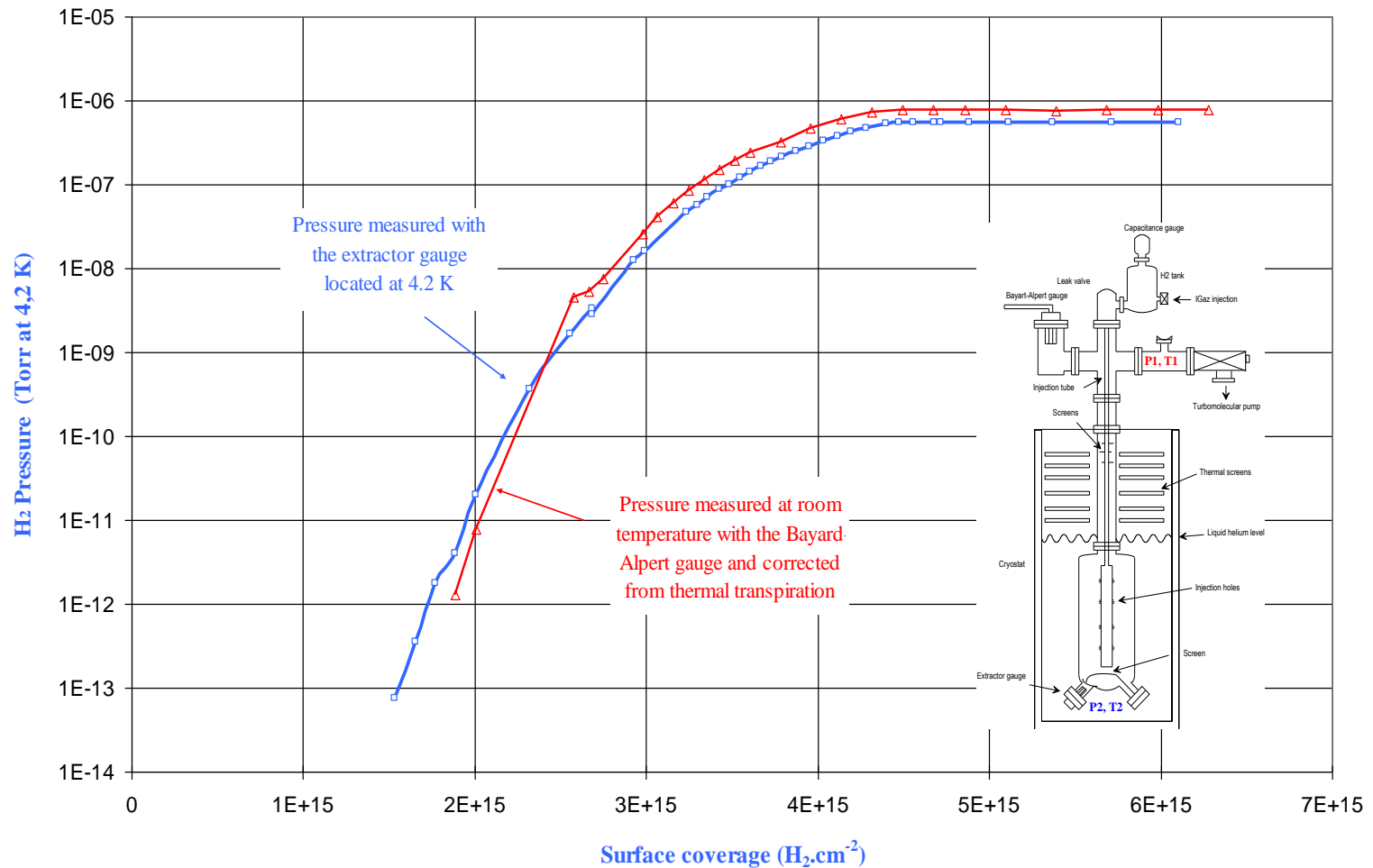

V. Baglin *et al.* CERN Vacuum Technical Note 1995

## 2. Adsorption isotherms

# Adsorption isotherm

- Measurement, at constant temperature, of the **equilibrium pressure** for a given gas coverage,  $\theta$
- Varies with:
  - molecular species
  - surface temperature (under 20 K only H<sub>2</sub> and He)
  - surface nature
  - gas composition inside the chamber
  - ...

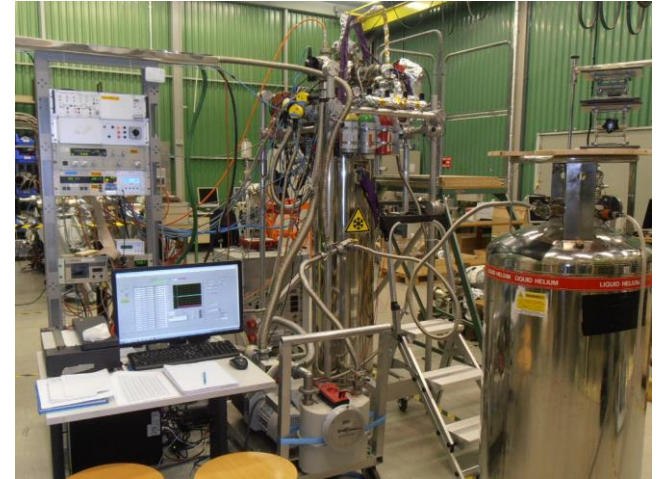

- Models :
  - Henry's law** for low surface coverage

$$\theta = cP$$

**DRK** (Dubinin, Radushkevich and Kaganer) for metallic, glass and porous substrate. Valid at low pressure. Good prediction with temperature variation

$$\ln(\theta) = \ln(\theta_m) - D \left( kT \ln \left( \frac{P_{Sat}}{P} \right) \right)^2$$

**BET** (Brunauer, Emmet and Teller). Multi-monolayer description

$$\frac{P}{\theta(P_{sat} - P)} = \frac{1}{\alpha \theta_m} + \frac{(\alpha - 1)}{\alpha \theta_m} \frac{P}{P_{sat}}$$

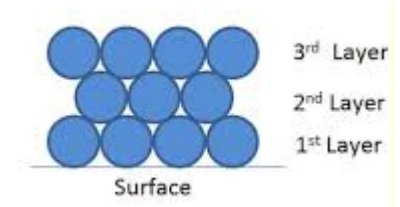

# Saturated Vapor Pressure

- Pressure over liquid or gas phase (**many** monolayers condensed)
- Follows the Clausius-Clapeyron equation:  $\text{Log } P_{\text{sat}} = A - B/T$
- For a smooth surface:

Saturated vapour pressure from Honig and Hook (1960)

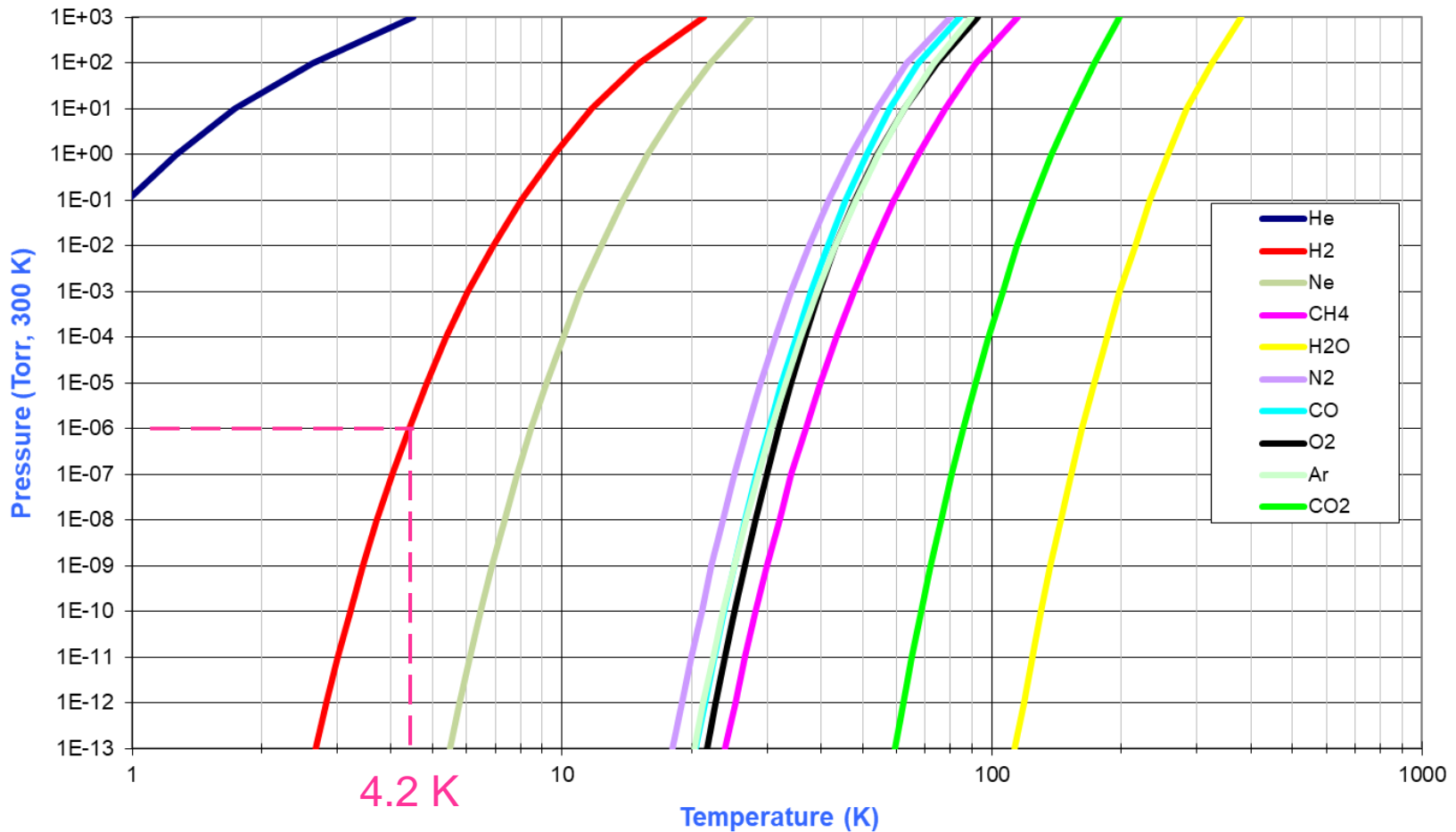



# H<sub>2</sub> Adsorption Isotherm on Stainless Steel

- The vapor pressure increases when increasing the adsorption of gas up to a few monolayers ( $\sim 10^{15}$  molecules/cm<sup>2</sup>)
- The vapor pressure saturates when several monolayers of gas are adsorbed
- The pressure level of the saturation is a function of the temperature

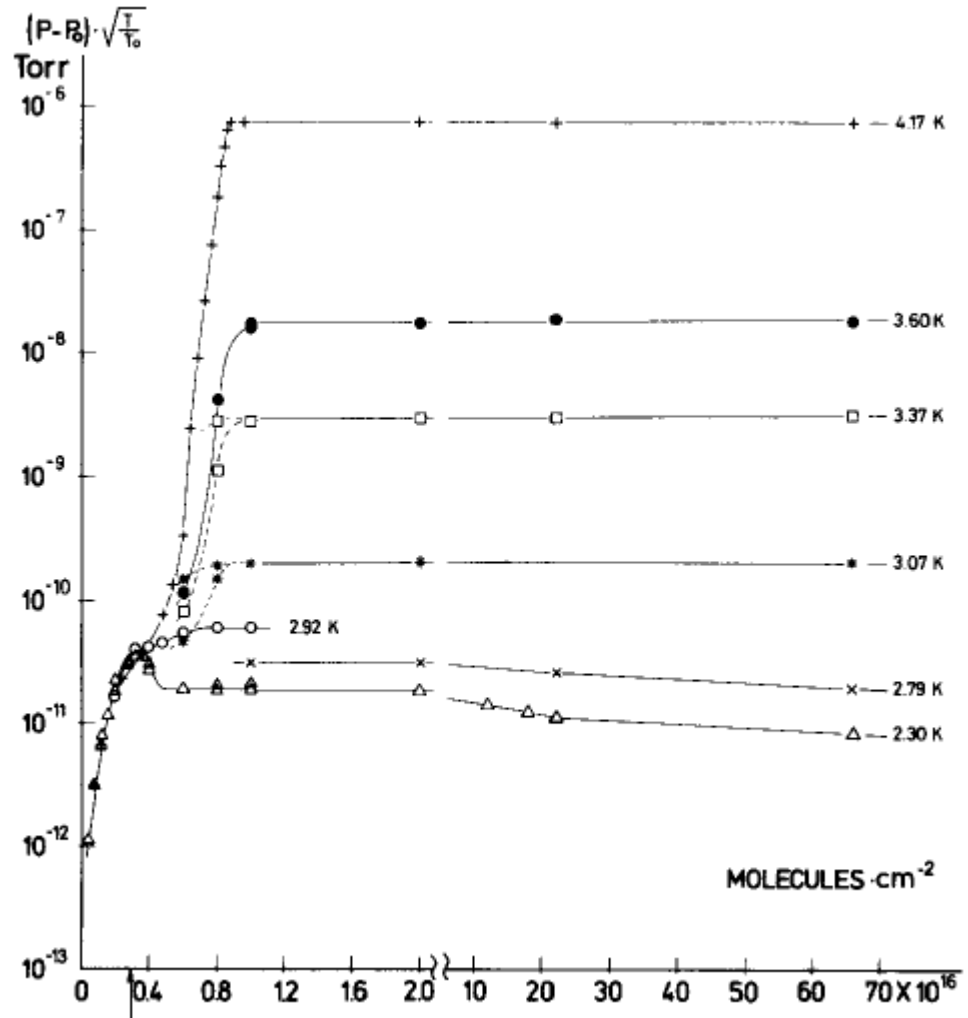

A monolayer

# H<sub>2</sub> adsorption isotherm on stainless steel

- The condensation cryopumps allows to pump large quantities of H<sub>2</sub> at 2.3 K.
- CERN ISR condensation cryopump operated with liquid He at 2.3 K (50 Torr on the He bath)

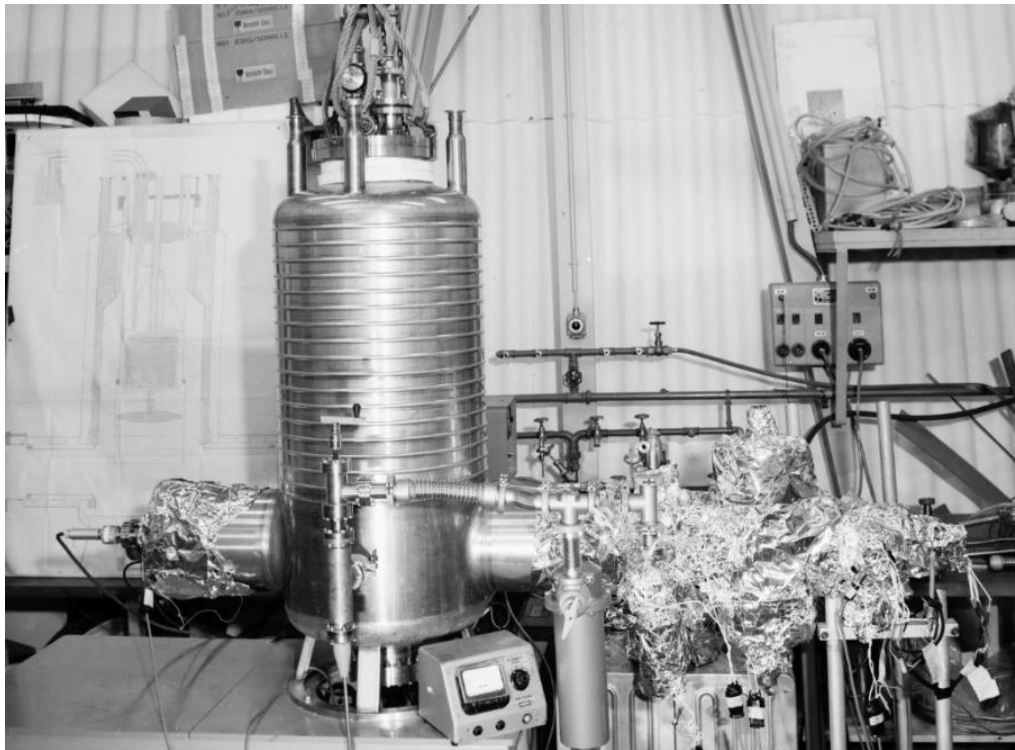

C. Benvenuti *et al.* Vacuum, 29, 11-12, (1974) 591

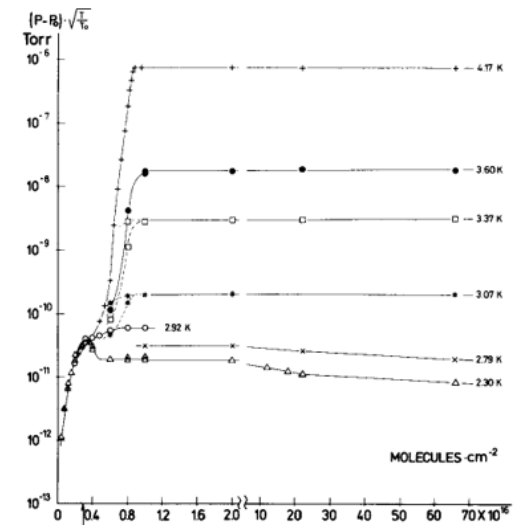

A monolayer

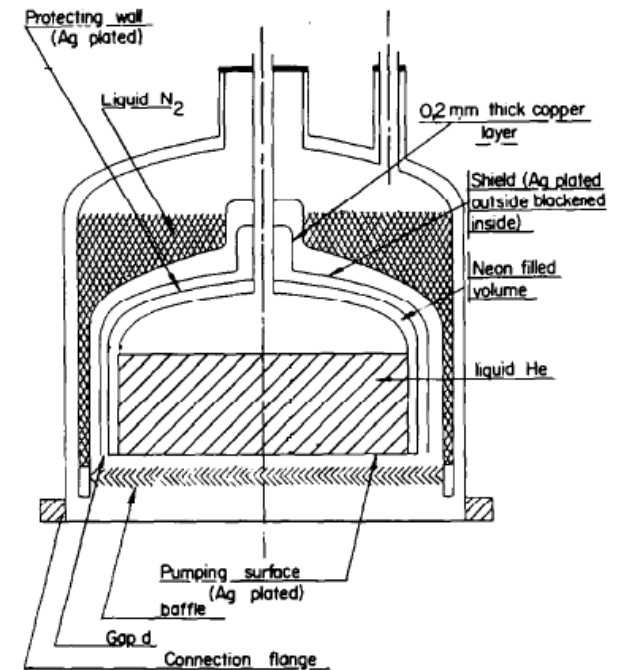

# H<sub>2</sub> adsorption isotherms from 8 to 20 K

- The surface capacity strongly decreases when increasing the surface temperature

- Stainless steel

- DRK description

$$\ln(\theta) = \ln(\theta_m) - D \left( kT \ln \left( \frac{P_{\text{Sat}}}{P} \right) \right)^2$$

- $D = 3125 \text{ eV}^{-2}$
- $\Theta_m = 7 \cdot 10^{14} \text{ H}_2/\text{cm}^2$

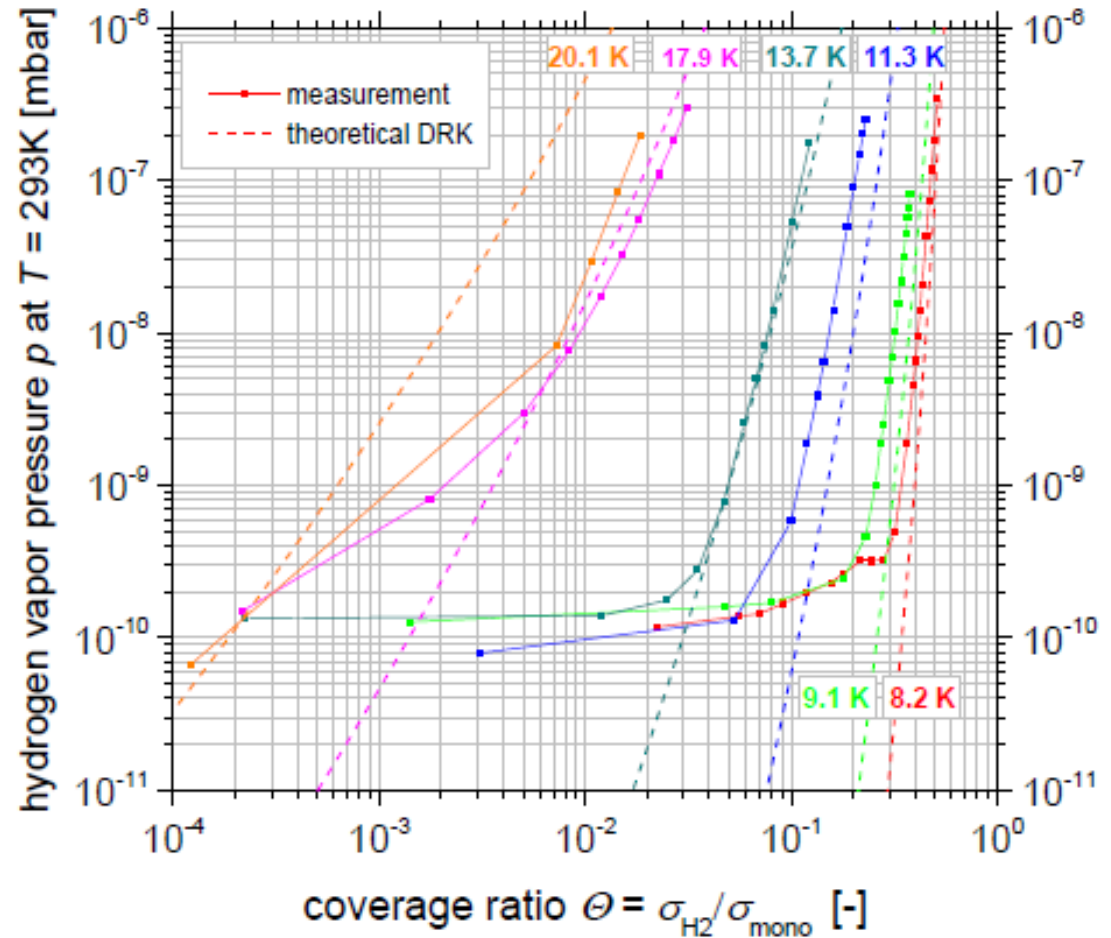

F. Chill *et al.* PAC'2015, Richmond, USA, 2015.

# Vapor Pressure in a Machine

- Several types of molecules are present in machine vacuum systems
- The adsorption isotherm is affected by the presence of these molecules
- Condensed CO<sub>2</sub> forms a porous layer increasing the hydrogen capacity
- Co-adsorption of CH<sub>4</sub>, CO and CO<sub>2</sub> reduce the vapor pressure of H<sub>2</sub> by cryotrapping

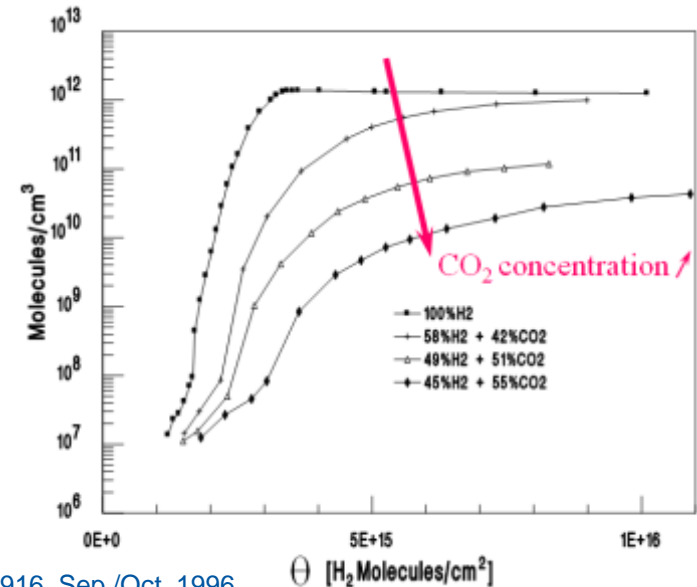
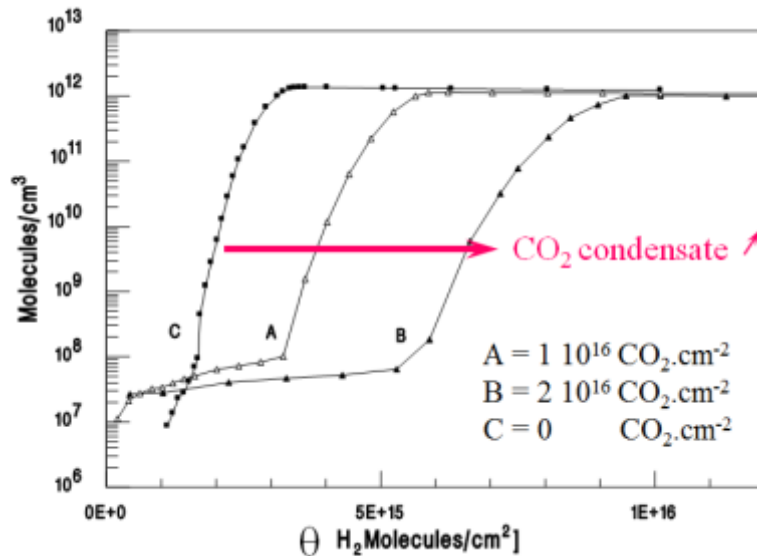

E. Wallén, JVSTA 14(5), 2916, Sep./Oct. 1996

→ Studies with real machine environments are mandatory

# H<sub>2</sub> Isotherms for Industrial Surfaces

- Identification of two types of adsorption sites with:
  - 1) high energy (pores, defects)
  - 2) low energy (flat surface).

Table 1  
Hydrogen adsorption capacity at 4.2 K

	Molecules/cm <sup>2</sup> at saturation: $\sigma_m$	Molecules/cm <sup>2</sup> at $P_{\text{sat}}$ ( $10^{-6}$ Torr): $\sigma_{\text{sat}}$	Ratio $\sigma_{\text{sat}}/\sigma_m$
<i>Smooth surfaces</i>			
Copper film unbaked	$6.07 \times 10^{15}$	$1.49 \times 10^{16}$	2.45
Electrochemical buffed stainless-steel unbaked	$2.36 \times 10^{15}$	$4.08 \times 10^{15}$	1.73
Electrochemical buffed stainless-steel baked	$2.68 \times 10^{15}$	$5.22 \times 10^{15}$	1.95
TiZrV film	$3.05 \times 10^{15}$	$6.02 \times 10^{15}$	1.97
<i>Porous surfaces</i>			
Al anodised unbaked (USA)	$1.23 \times 10^{17}$	—	—
Al anodised baked (USA)	$1.80 \times 10^{17}$	—	—
Al anodised (KEK)	$8.1 \times 10^{16}$	$1.18 \times 10^{17}$	1.46

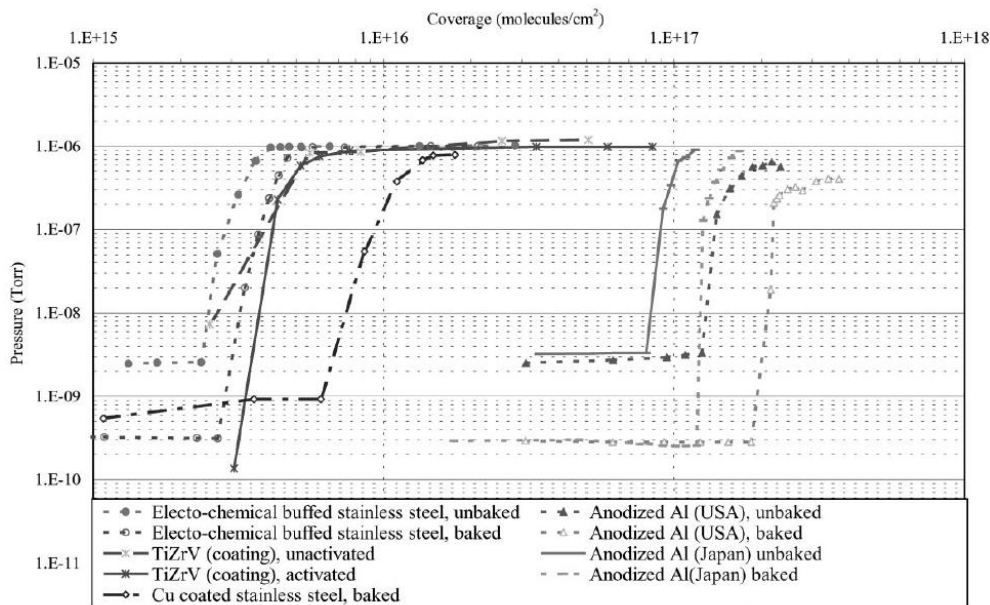

Fig. 3. Hydrogen adsorption isotherm at 4.2 K for various samples.

G. Moulard, B. Jenniger, Y. Saito, Vacuum 60 (2001) 43-60

# Cryosorbing materials

- Large capacity
- Large pumping speed
- Large temperature working range (up to ~ 30 K)

e.g. **activated charcoal** used for cryopumps

Capacity ~  $10^{22}$  H<sub>2</sub>/g i.e.  $10^{21}$  monolayers (P. Redhead, Physical basis of UHV, 1968)

Sticking coefficient ~ 30 % at 30 K (T. Satake, Fus. Tech. Vol 6., Sept. 1984)

used for cryopanel held at 20 K

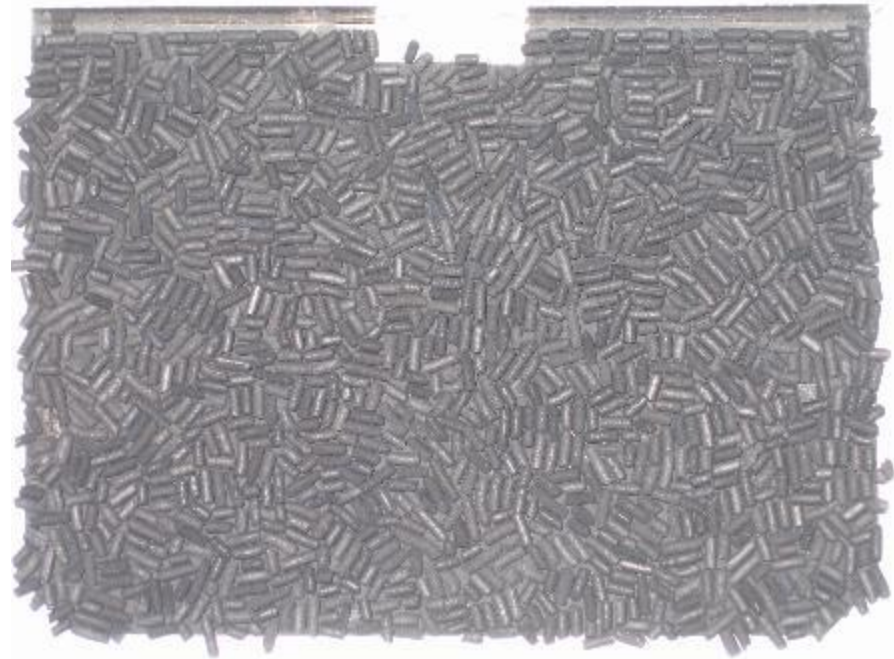
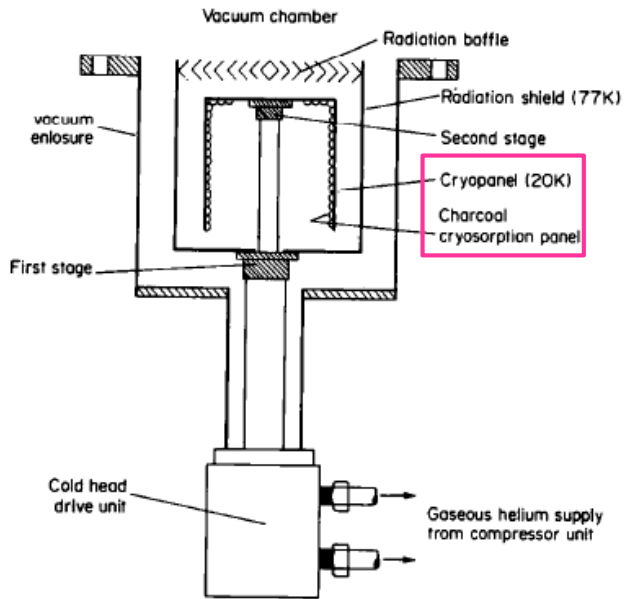

# B.E.T surface area determination

- Xe is an inert gas which can only be physisorbed on a surface
- Xe adsorption isotherms at 77 K are used to derive the roughness factor, R, of a surface using the BET multi-monolayer theory

$$\frac{P}{\theta(P_{Sat}-P)} = \frac{1}{\alpha \theta_m} + \frac{(\alpha-1)}{\alpha \theta_m} \frac{P}{P_{Sat}} \approx \frac{1}{\theta_m} \frac{P}{P_{Sat}}$$

- Valid for  $0.01 < P/P_{sat} < 0.3$
- BET monolayer =  $\theta_m$
- $\alpha = \exp(\Delta E/kT) \gg 1$

$$R = \frac{A_R}{A_G} = \frac{A \times \theta_m}{A_G}$$

A for Xenon  $\sim 25 \text{ \AA}^2$

$A_R$  = real area  
 $A_G$  = geometrical area

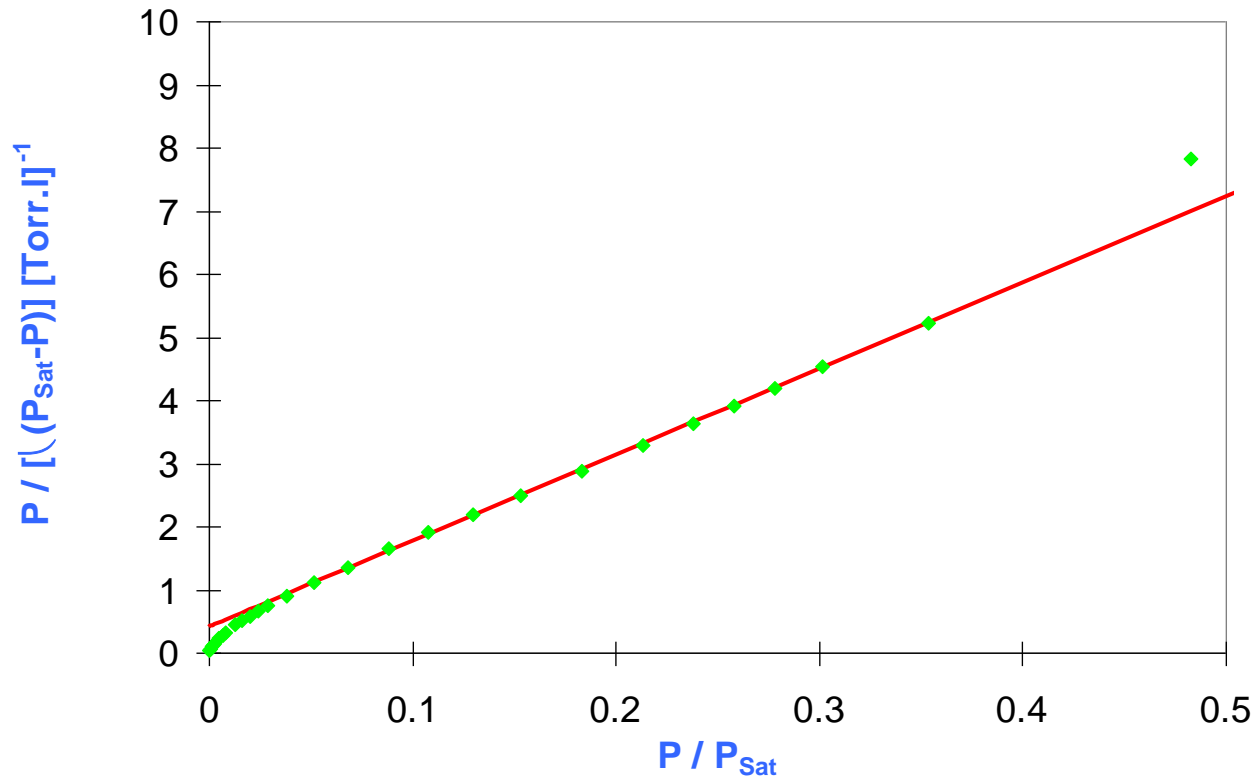

# B.E.T set-up

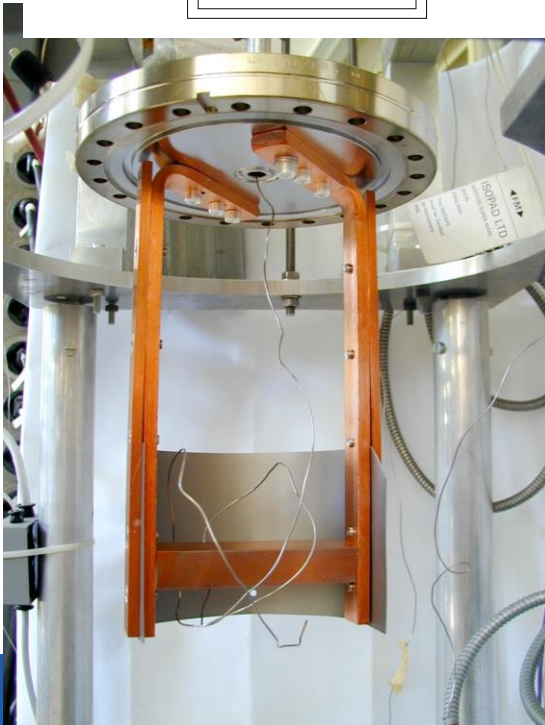
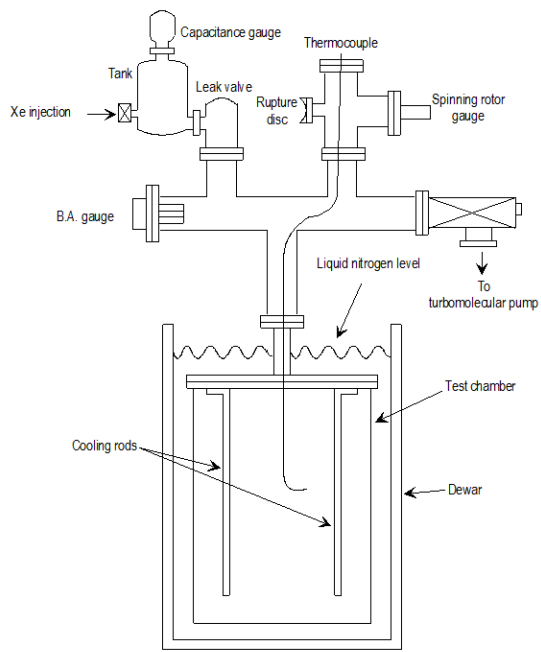



# Roughness factor

- Xe saturated vapour pressure  $\sim 2.6 \cdot 10^{-3}$  Torr at 77 K

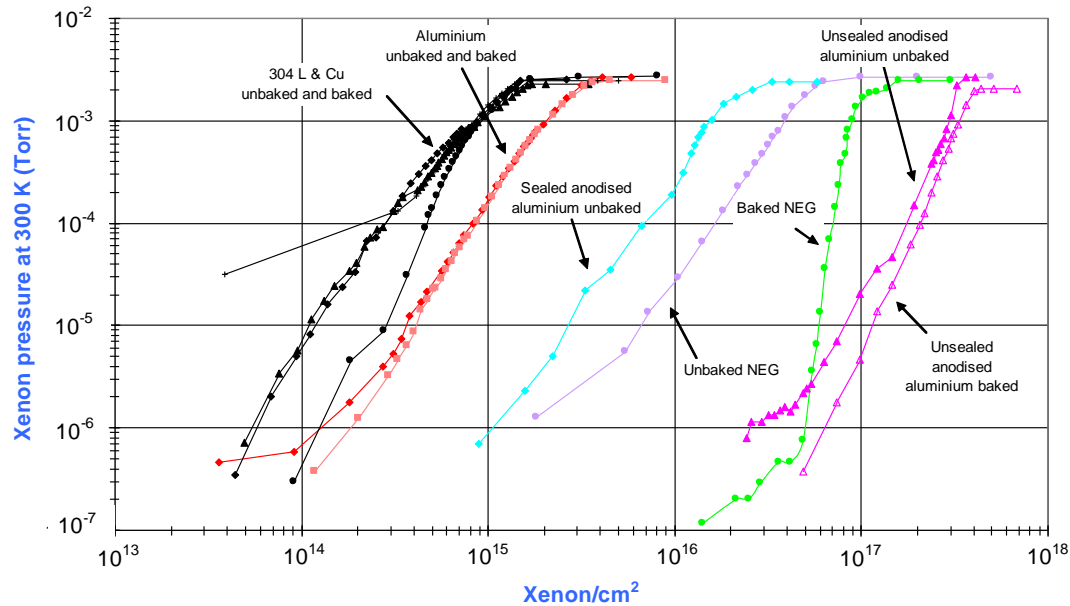

Technical surface	Unbaked	Baked at 150 °C
Copper Cu-DHP acid etched	1,4	1,9
Stainless steel 304 L vacuum fired	1,3	1,5 (at 300 °C)
Aluminium degreased	3,5	3,5
Sealed anodised aluminium 12 V	24,9	not measured
Unsealed anodised aluminium 12 V	537,5	556,0
NEG St 707	70,3	156,3

V. Baglin. CERN Vacuum Technical Note 1997

### 3. Cryosorbers in cold systems.

Case of the LHC superconducting magnets  
operating at 4.5 K

# LHC Long straight section vacuum system

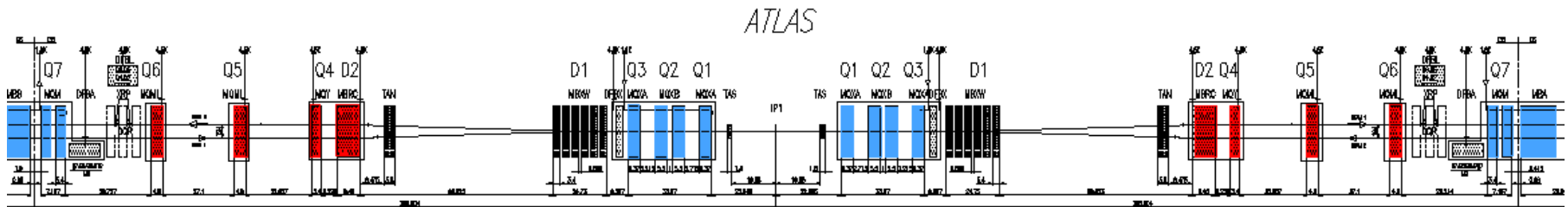

- Focusing inner triplets located around experiments operate at 1.9 K
- Matching sections operate at 4.5 K
- 1.9 K cold bore (~660 m, arc beam screen technology)
- ~ 4.5 K cold bore (~ 740 m)

} Perforated beam screens

## With a 4.5 K Cold Bore

- Saturated vapour pressure equals  $2 \cdot 10^{-5}$  mbar
- Cryosorbers are needed to provide a porous surface

Hydrogen saturated vapour pressure from Honig and Hook (1960)

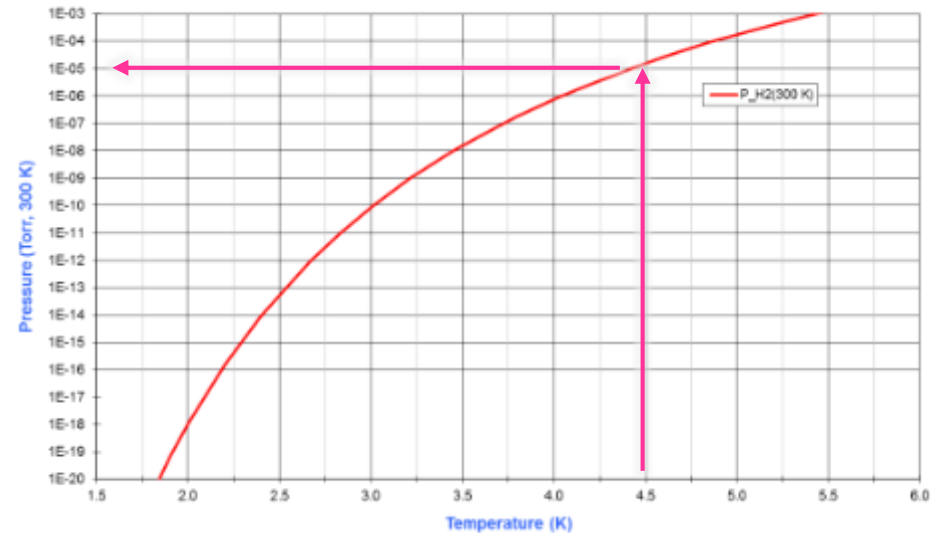

# H<sub>2</sub> adsorption isotherm on cryosorbers

- Woven carbon fibers are used in LHC as cryosorbers in 4.5 K magnets
- Beam screen operates in the 5-20 K range

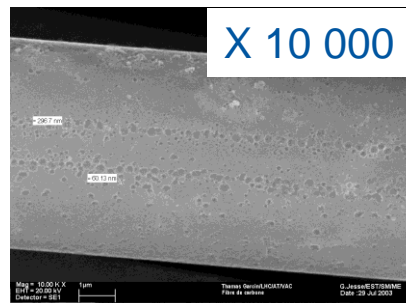
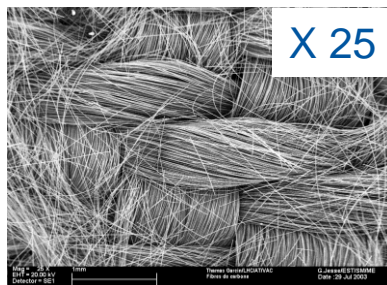
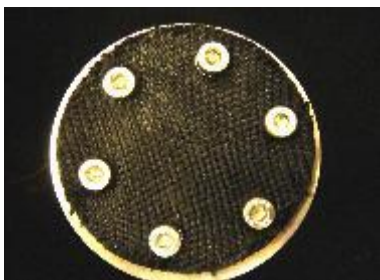

V. Anashin *et al.* Vacuum 75 (2004) 293-299

- Sticking probability at  $10^{18}$  H<sub>2</sub>/cm<sup>2</sup> :

15 % at 22 K  
> 15 % below 22 K

- Capacity at  $10^{-8}$  mbar :  
 $10^{18}$  H<sub>2</sub>/cm<sup>2</sup> at 6 K  
 $10^{17}$  H<sub>2</sub>/cm<sup>2</sup> at 30 K

$$R \sim 10^3 R_{Cu}$$

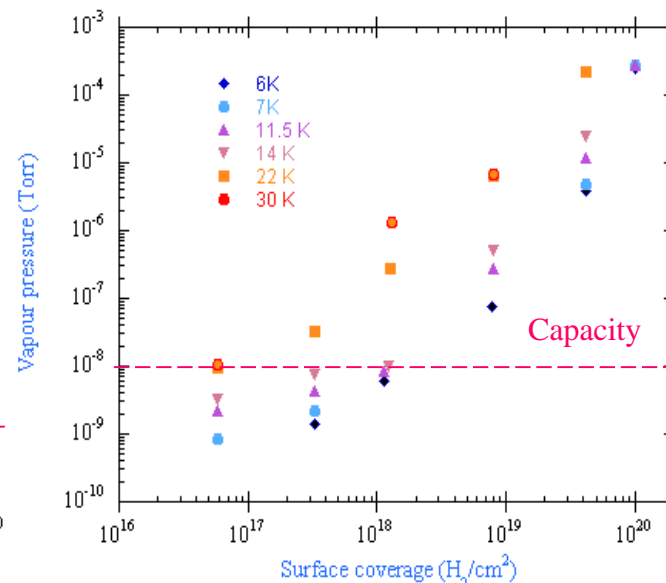
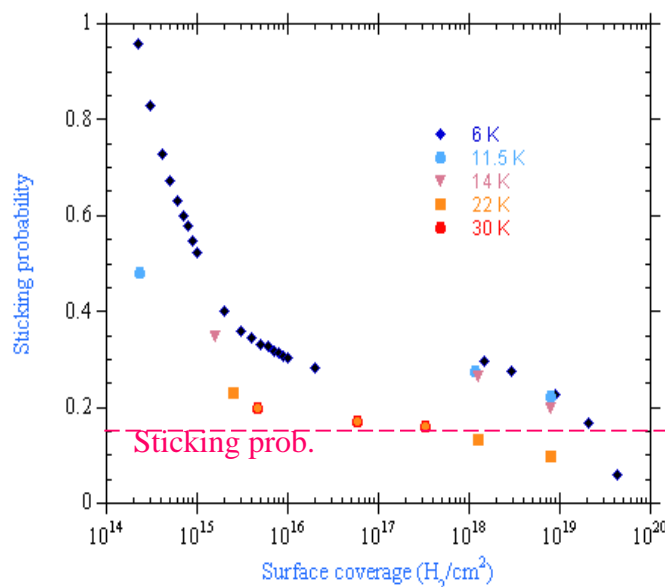

V. Baglin *et al.* EPAC'04, Luzern 2004.

# Pumping speed measurement

- Fisher-Mommsen dome (Vacuum, vol. 17, 6, (1967), 309-315)
- The pumping speed is measured during the gas injection
- The vapor pressure is measured after injection, when  $dP/dt = 0$

$$S = \frac{C (\Delta P_1 - \Delta P_2)}{\Delta P_2}$$

$$\sigma = \frac{S}{S_{\max}}$$

$C = 10.5 \text{ l/s for H}_2$

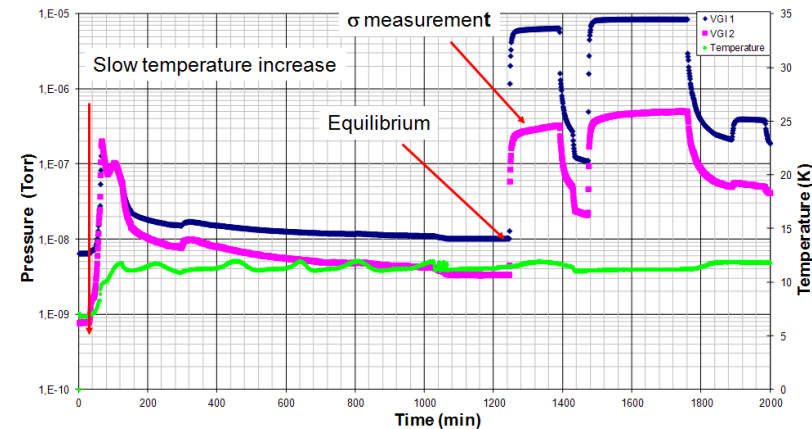
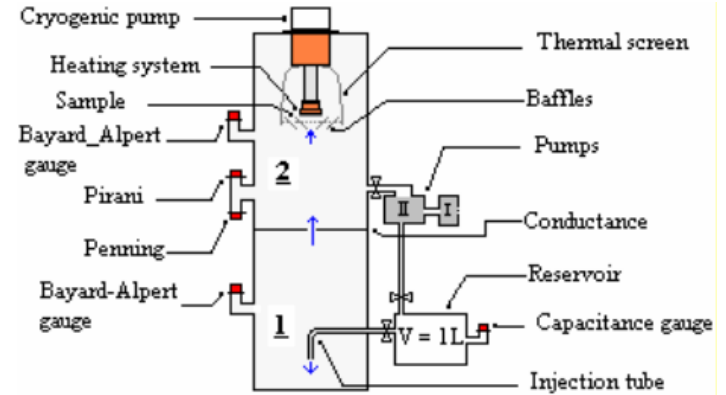
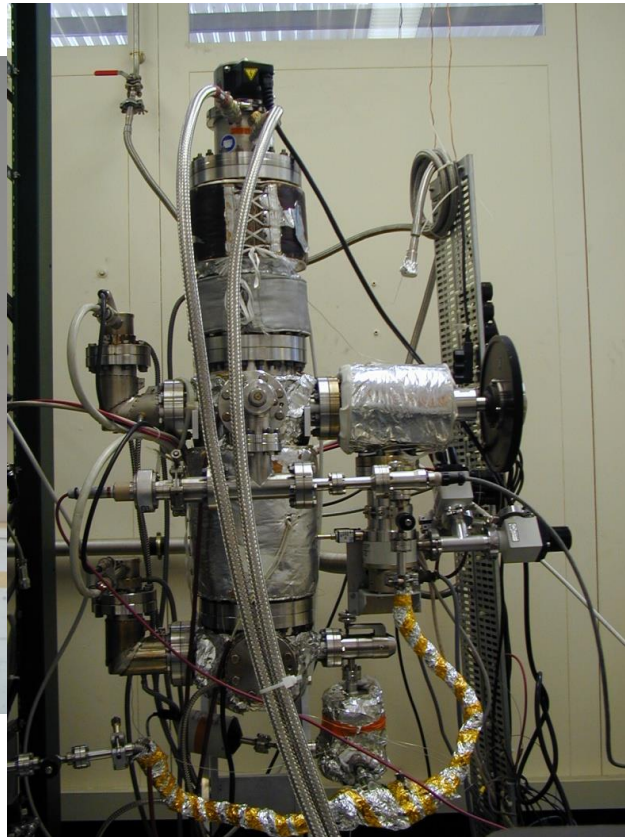

# 4. He leaks in cold systems

# LHC : Superconducting technology

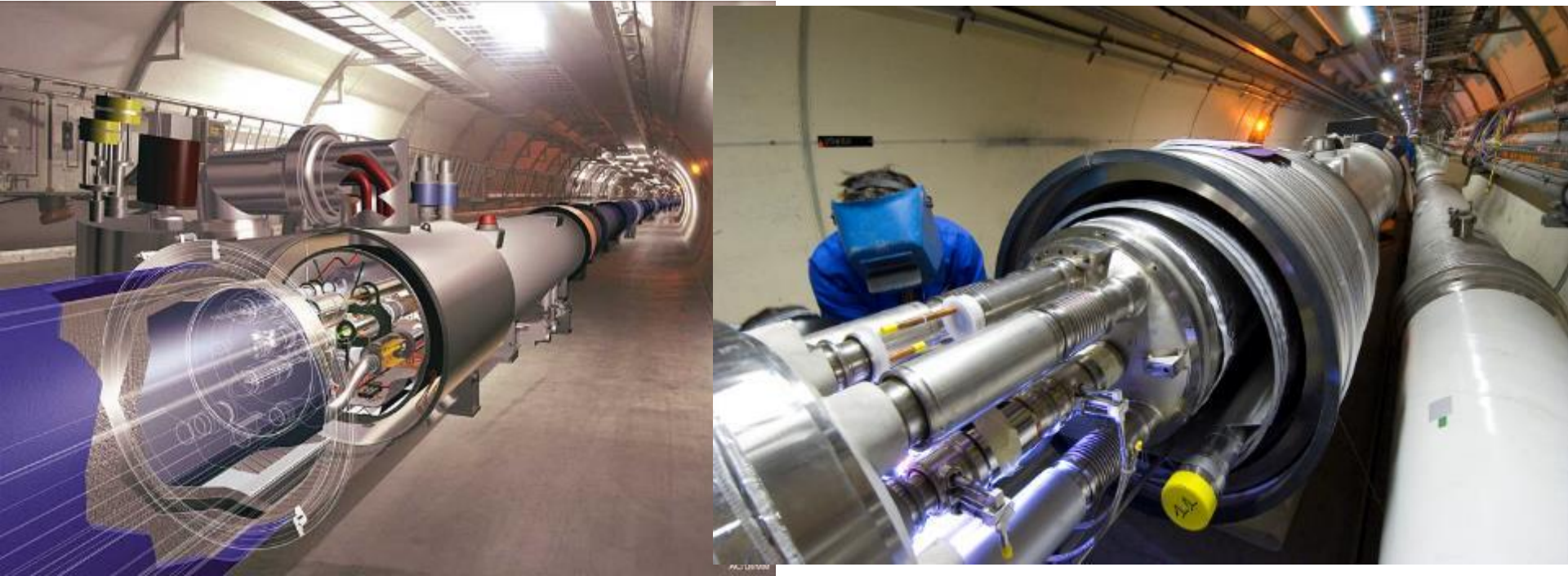

- Air leak or He leaks could appear in the beam tube during operation : the consequences are risk of magnet quench, pressure bump and radiation dose

# He adsorption isotherm from 1.9 to 4.2 K

- Sub-monolayer range
- Approaches Henry's law at low coverage
- The isotherms are well described by the DRK model
- $\theta_m \sim 1.3 \cdot 10^{15} \text{ H}_2/\text{cm}^2$
- Stainless steel

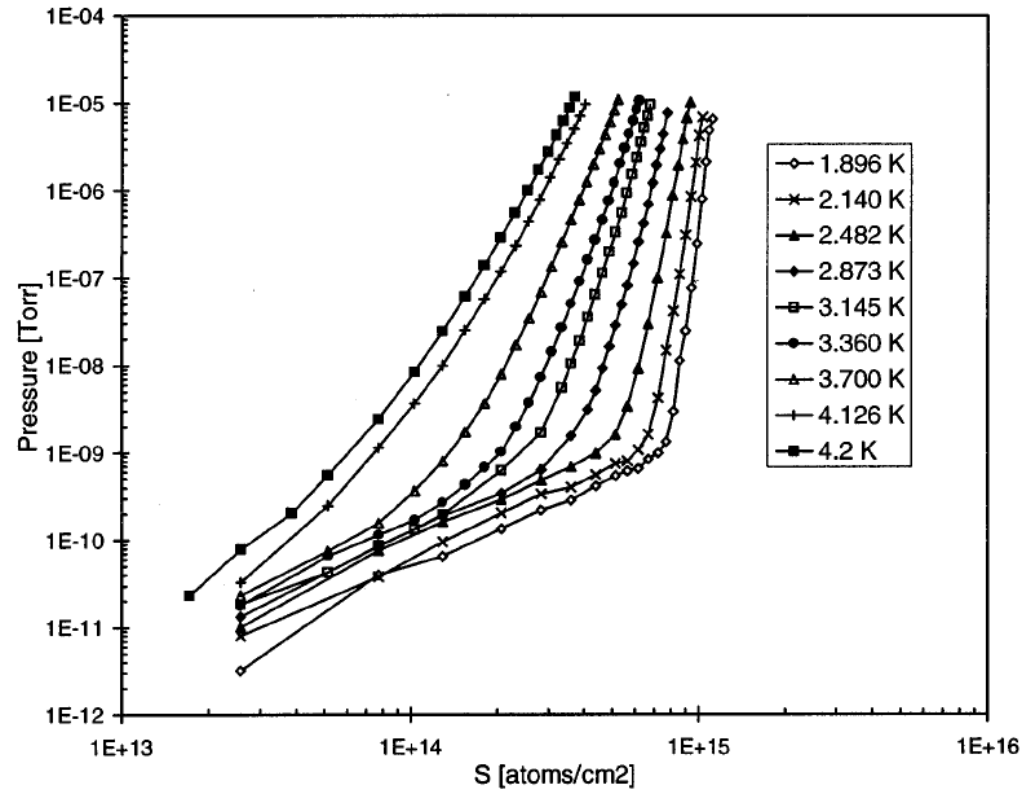

E. Wallén. J.Vac.Sci.A 15(2), Mar/Apr 1997, 265-274.



# He leaks at 1.9 K

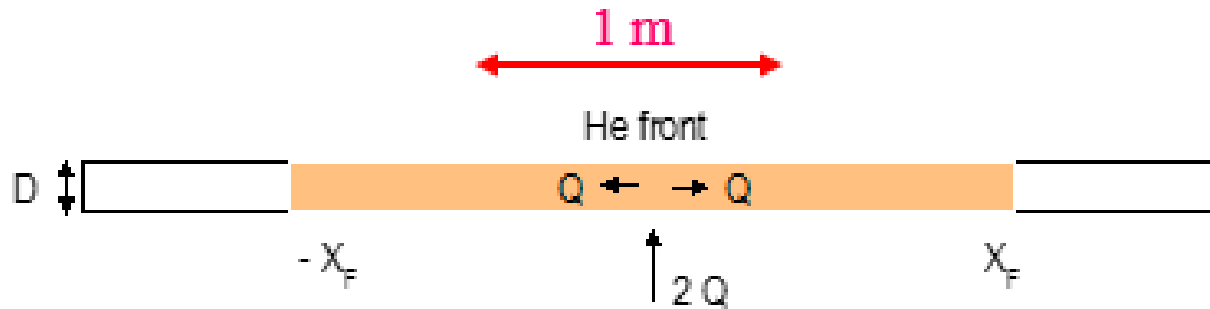

P. Hobson *et al.* J.Vac.Sci. A. 11(4), Jul/Aug 1993, 1566-1573

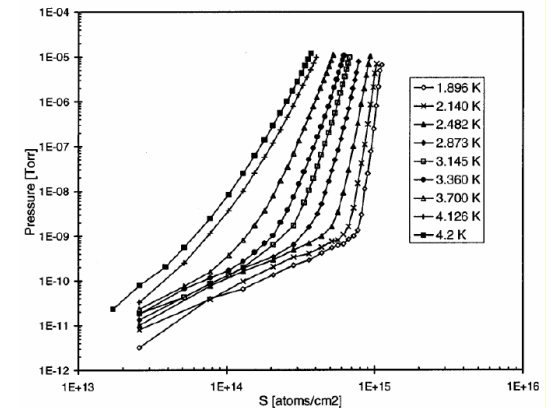
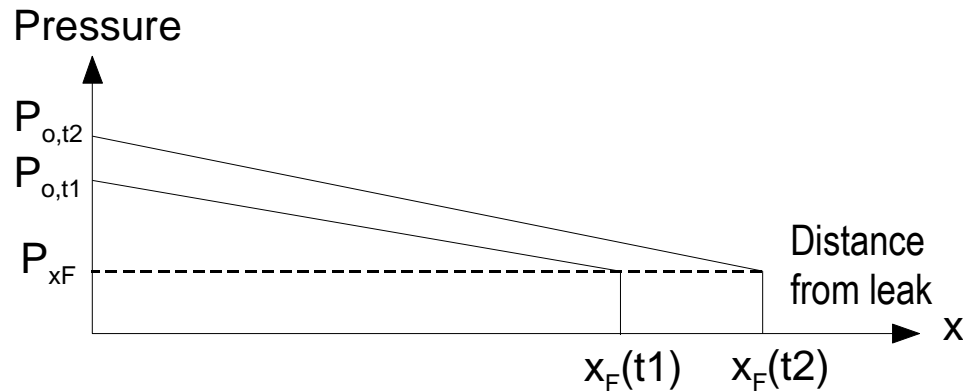

E. Wallén. J.Vac.Sci.A 15(2), Mar/Apr 1997, 265-274.

- A He pressure wave is developed with time along the beam vacuum chamber
- The He wave can span over several tens of meter without being detected
- The local pressure bump gives a local proton loss (risk of quench)

# Example: LHC test string

Example : LHC Test string

Leak rate  $6 \cdot 10^{-5}$  Torr.l/s

Distance 75.3 m

20h to be detected 75 m downstream!

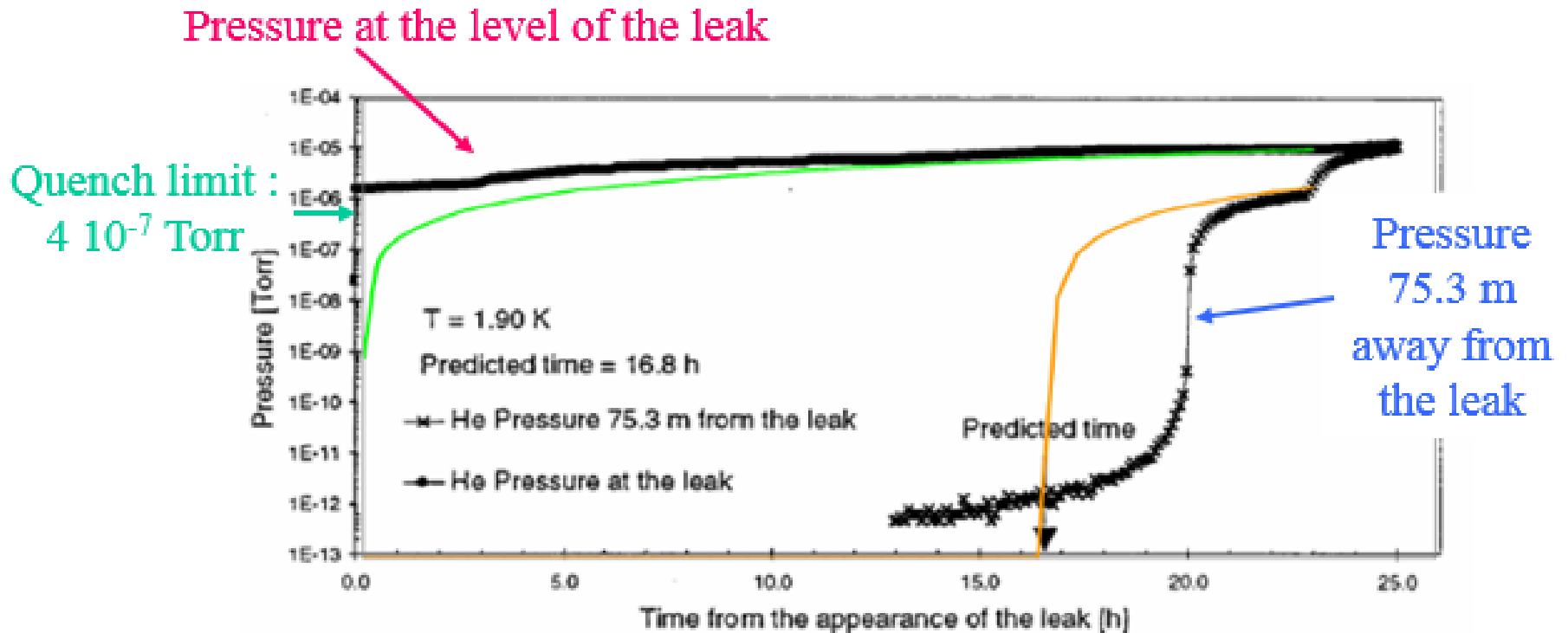

E. Wallén, JVST A 15(6), Nov/Dec 1997

# RHIC, Brookhaven, USA

- RHIC's solution: anticipate leaks !!
- RHIC use sorption pumps based on 300 g of **activated charcoal**.
- They are located every 30 m to mitigate He leaks and to pump H<sub>2</sub>

Test in a 480 m long sector at 4.4 K

## RHIC interconnect

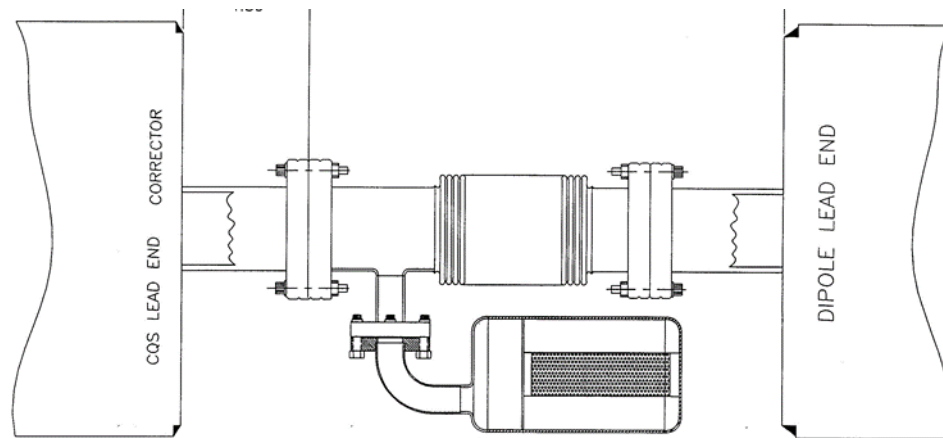

H.C. Hseuh, Proc. PAC 1999

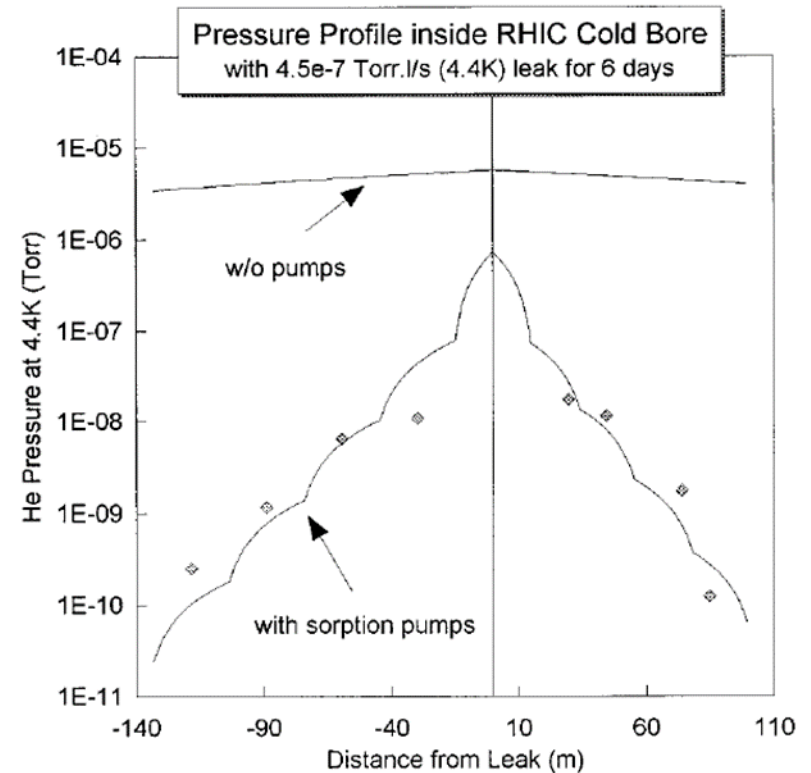

H.C. Hseuh, E. Wallén.  
J.Vac.Sci.A 16(3), May/Jun 1998, 1145-1150.

# Lecture 3 summary

- Gas can be physisorbed for **very long period** on cryogenic surface
- The **sticking coefficient** characterise the pumping speed of a surface
- The **capture coefficient** characterise the pumping speed of a device
- At cryogenic temperature, **thermal transpiration** correction shall be applied
- The **vapour pressure** is the equilibrium pressure as a function of gas coverage
- When **saturated** (many monolayers), the vapour pressure follows the Clausius Clapeyron law
- **Adsorption isotherms** vary very much with the conditions
- Some material can be porous so to adsorb many monolayers of gas without reaching the saturated vapour pressure: **cryosorbers**
- He leak can be difficult to detected at cryogenic temperature

# Some References

- Cern Accelerator School, Vacuum technology, CERN 99-05
- Cern Accelerator School, Vacuum in accelerators, CERN 2007-03
- Cern Accelerator School, Vacuum for particle accelerators, Glumsløv, June 2017
- The physical basis of ultra-high vacuum, P.A. Redhead, J.P. Hobson, E.V. Kornelsen. AVS.
- Capture pumping technology, K. Welch, North Holland.
- Cryopumping, theory and practice, R. Haefer, R. Clarendon press

## Some Journals Related to Vacuum Technology

- Journal of vacuum science and technology
- Vacuum

**Thank you for your attention !!!**





# Complementary information





## 2. Adsorption isotherms

# “Anomalous” Saturated Vapor Pressure

Complementary information

## Thermal radiation induced desorption:

- In a “LHC type” mock-up (COLDEX):
- After condensation of 10 monolayers of H<sub>2</sub>, the pressure follows the Clausius-Clapeyron equation while the cold bore temperature is decreased from 4 to 3 K
- Below 3 K, a **deviation** is observed due to the thermal radiation coming from the room temperature parts located at the extremities of the 2 m long system.
- Increasing the **beam screen** temperature from 20 K to 100 K has no impact on the observed deviation while the cold bore is held at 2.7 K

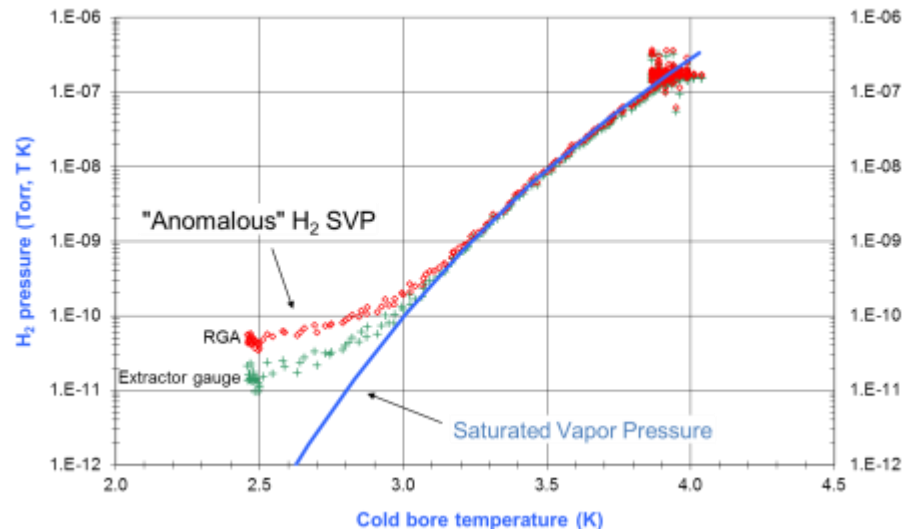

- Cryopump optimisation:
- 10 monolayers of H<sub>2</sub> is condensed at 2.3 K
- The different cryosurface types are fully exposed to 300 K radiation
- **Linear dependence with the absorbed power** (incident radiation x substrate emissivity)
- The pressure, measured at 2.3 K, varies from 10<sup>-10</sup> to 10<sup>-8</sup> Torr  
=> gas density 5 · 10<sup>14</sup> to 5 · 10<sup>16</sup> H<sub>2</sub>/m<sup>3</sup>

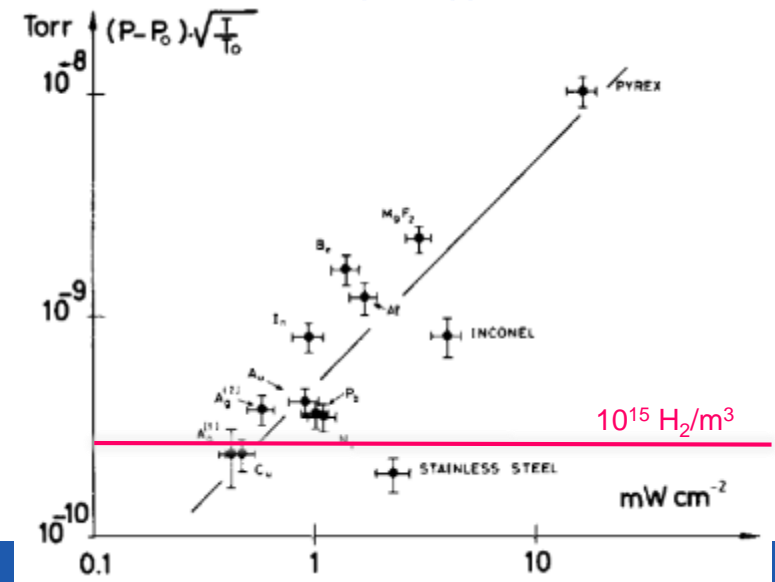

V. Baglin, B. Jenninger,  
COLDEX Run 24, September 1999

C. Benvenuti, R. Calder, G. Passardi  
J.Vac.Sci. 13(6), Nov/Dec 1976, 1172-1182

# H<sub>2</sub> adsorption isotherm at 4.2 K on CO<sub>2</sub> condensate

Complementary information

- CO<sub>2</sub> films growth in packing form

→ Porous layer

- DRK adsorption capacity :  
0.3 H<sub>2</sub>/CO<sub>2</sub>

- Electroplated Cu

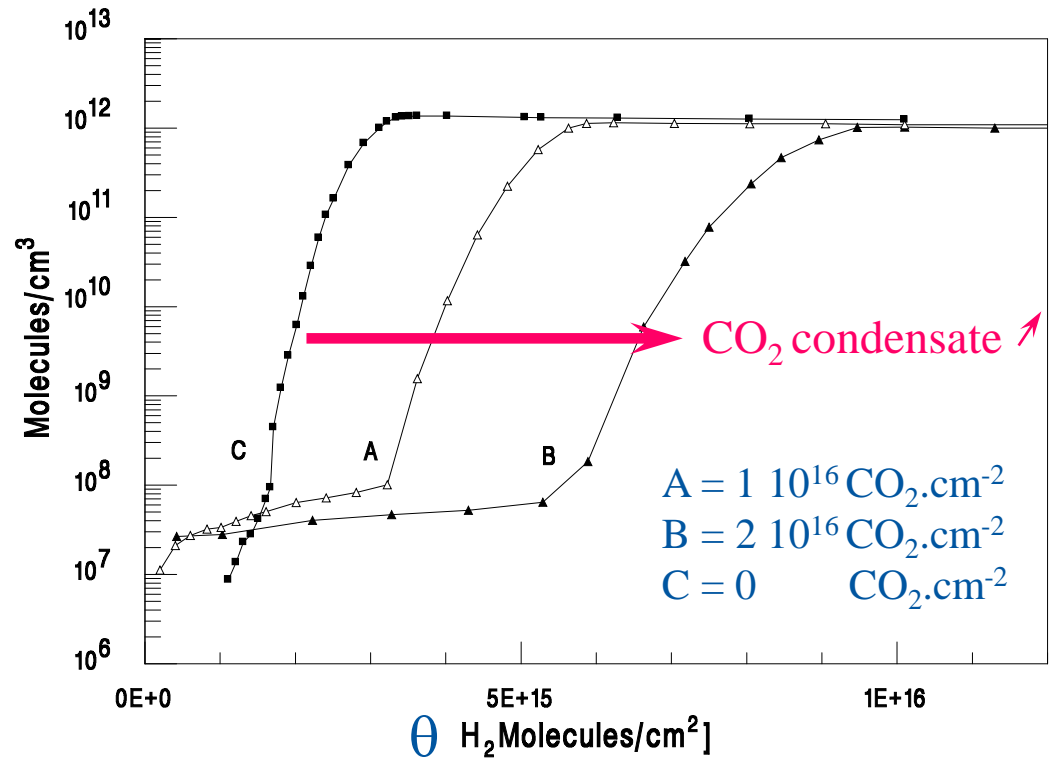

E. Wallén, JVSTA 14(5), 2916, Sep./Oct. 1996

# H<sub>2</sub> adsorption isotherm at 4.2 K in co-adsorption with CO<sub>2</sub>

Complementary  
information

- Reduction of the saturated vapour pressure by orders of magnitude

→ Cryotrapping

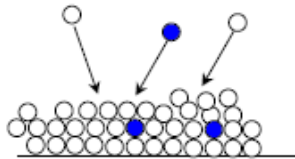

- Electroplated Cu
- In cryopumps CO<sub>2</sub> is admitted to enhance the pumping of H<sub>2</sub> and He

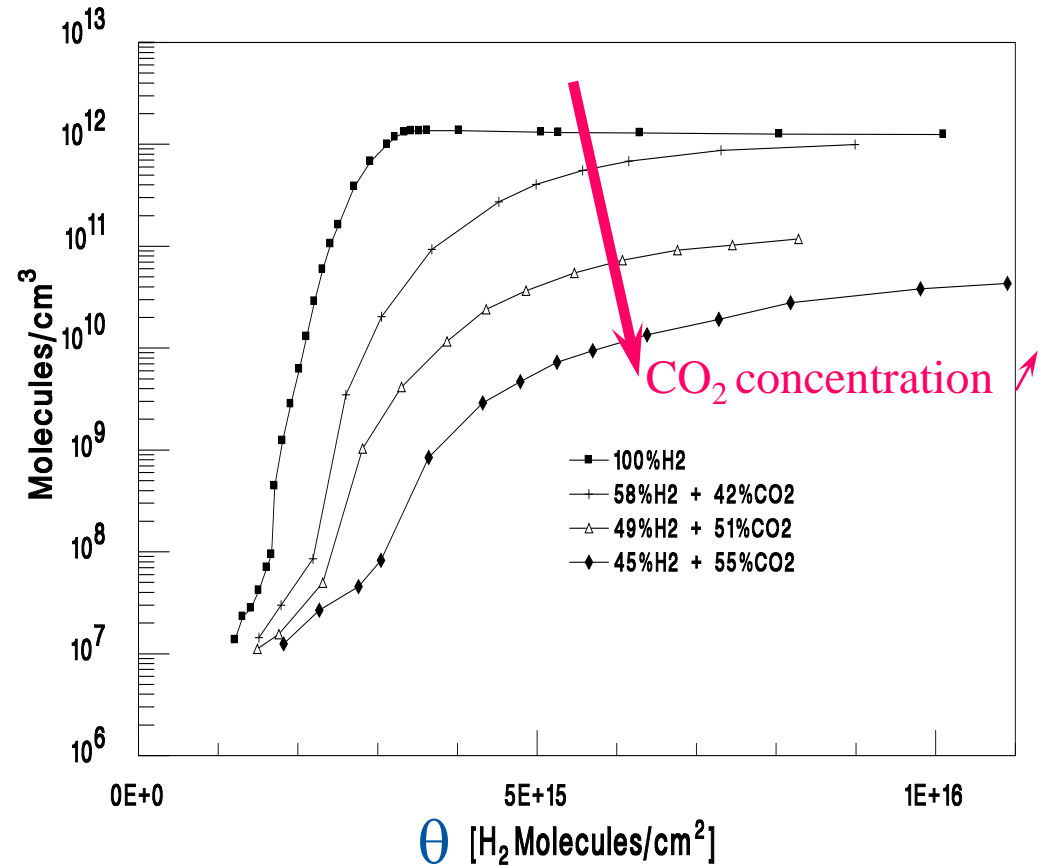

E. Wallén, JVSTA 14(5), 2916, Sep./Oct. 1996

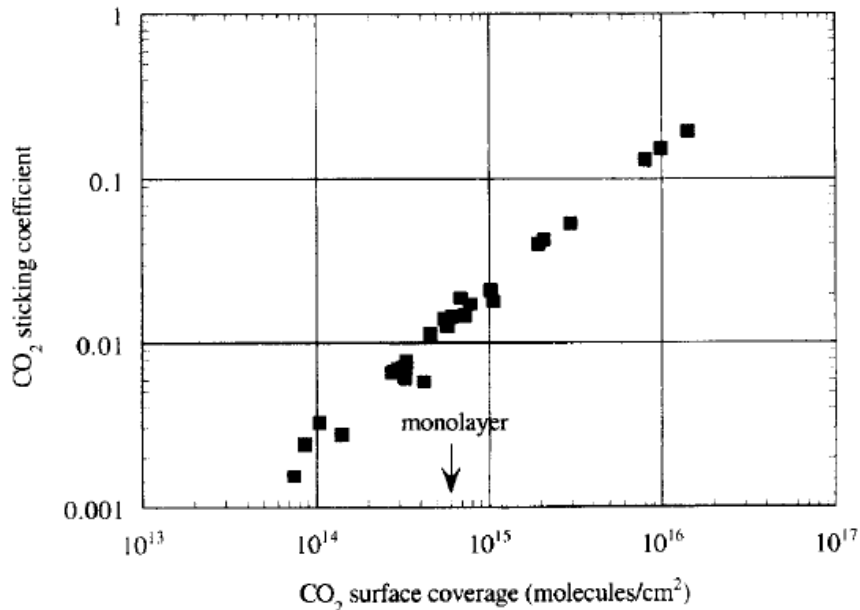

**Figure 2.** The sticking coefficient for CO<sub>2</sub> at 77 K as a function of the surface coverage.

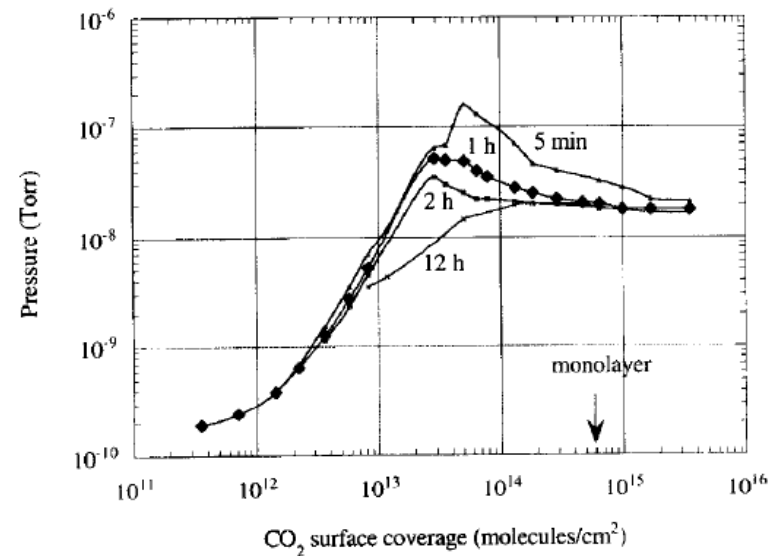

**Figure 3.** Adsorption isotherm for CO<sub>2</sub> at 77 K as a function of surface coverage. The curves refer to measurements for different waiting times for pressure stabilisation.

V.V Anashin et al, Vacuum 48 (1997) 785-788

- Metallic surface
- Below a monolayer, the equilibrium pressure of the isotherm is obtained after **several hours**
- Due to the low sticking coefficient and the molecular adsorption by cluster.

### 3. Cryosorbers in cold systems.

Case of the LHC superconducting magnets  
operating at 4.5 K

# LHC dipole vacuum system

Complementary  
information



- Cold bore (CB) at **1.9 K**
- Beam screen (BS) at 5-20 K (intercept thermal loads)



LHC DIPOLE : STANDARD CROSS-SECTION

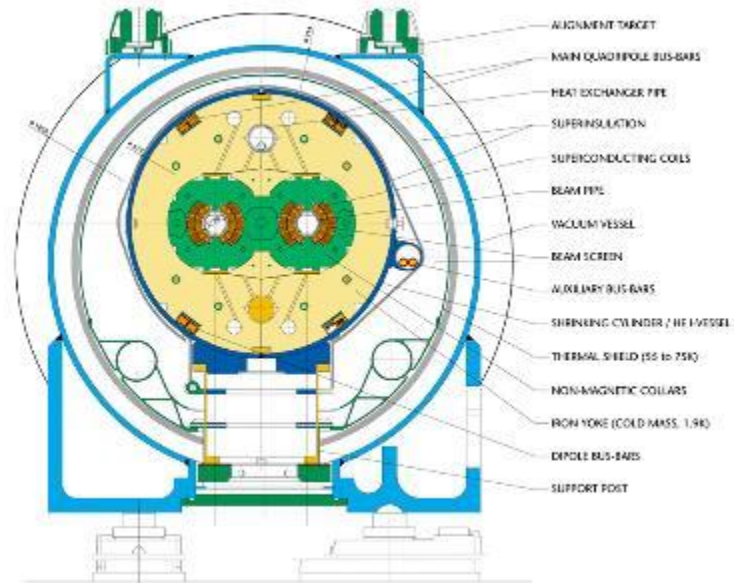

CERN AC/CD/98-16 - HELVET - 30.04.1999

# LHC vacuum system principle

Complementary information

- Molecular desorption stimulated by photon, electron and ion bombardment
- Desorbed molecules are pumped on the beam vacuum chamber
- 100 h beam life time (nuclear scattering) equivalent to  $\sim 10^{15}$  H<sub>2</sub>/m<sup>3</sup> ( $10^{-8}$  Torr H<sub>2</sub> at 300 K)

## In cryogenic elements

- Molecular **physisorption** onto cryogenic surfaces (weak binding energy)
- Molecules with a low recycling yield are **first physisorbed onto the beam screen** (CH<sub>4</sub>, H<sub>2</sub>O, CO, CO<sub>2</sub>) and **then onto the cold bore**
- H<sub>2</sub> is physisorbed onto the cold bore

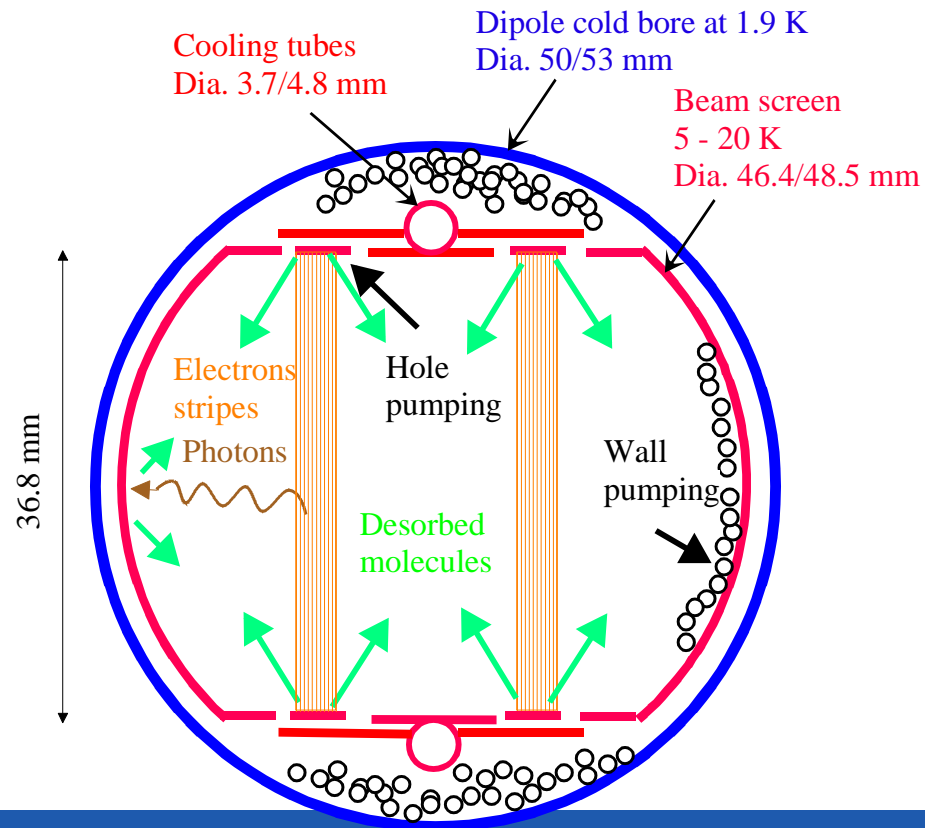



# LHC cryosorbers requirements

Complementary information

- The Design requires > 100 h life time with 4.5 K cold bore and thick surface coverage
- Taking into account the gas loads due to the beam stimulated molecular desorption
- Required performances (for installation of 200 cm<sup>2</sup>/m):
  - Operates from 5 to 20 K
  - Capacity larger than 10<sup>18</sup> H<sub>2</sub>/cm<sup>2</sup>
  - Capture coefficient larger than 15 %

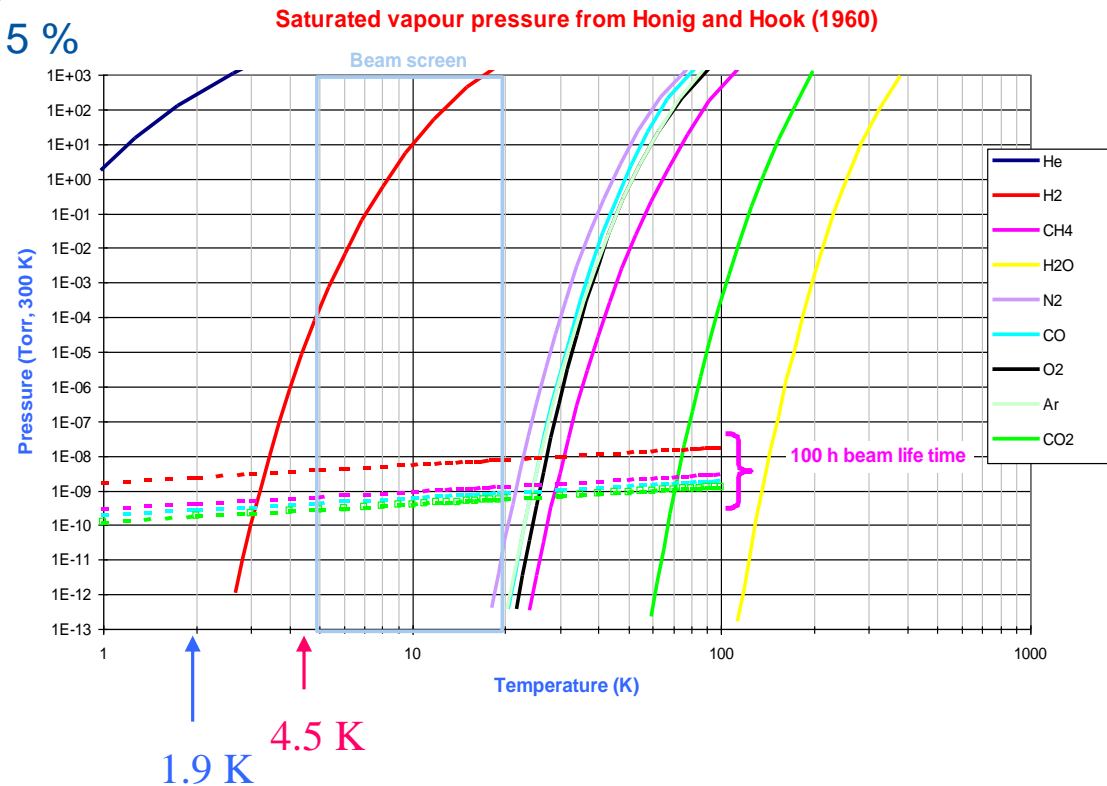
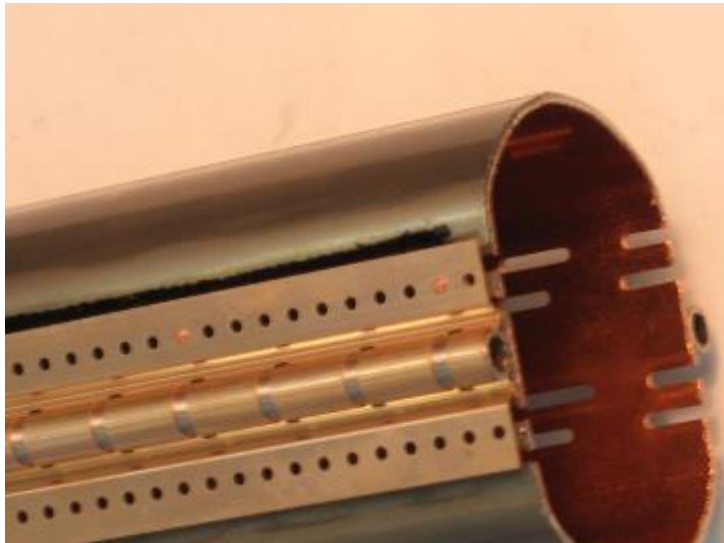

# LHC Cryosorber Validation By Gas Injection

Complementary information

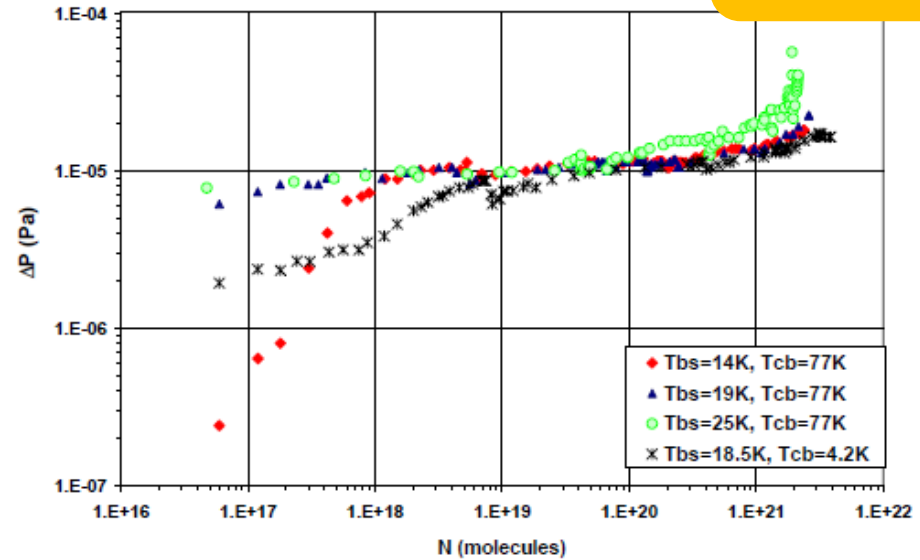
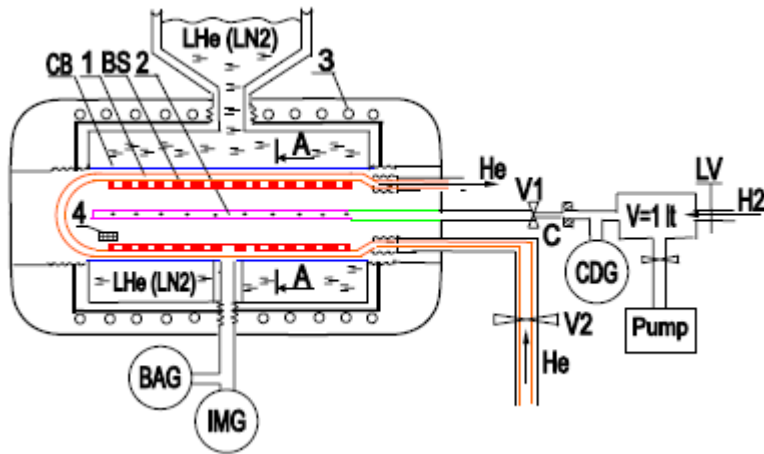

Fig. 3. Dynamic pressure measured by the gauge at room temperature in 1-m long LHC vacuum chamber prototype with a beam screen at different temperatures. Dynamic pressure is normalised to the injecting  $H_2$  flux  $10^{15}$  molecule/s.

V.V Anashin et al, Vacuum 75 (2004) 293-299

- The dynamic pressure is below design value (*i.e.*  $10^{-8}$  mbar) for a molecular flux less than  $10^{14} H_2/s$ 
  - When  $\eta_{\text{photon}} \sim 10^{-4} H_2/\text{ph}$ , then maximum photon flux is 10x LHC SR
  - When  $\eta_{\text{electron}} \sim 10^{-3} H_2/\text{ph}$ , the corresponding electron cloud heat load is  $\sim 1$  W/m

# Operation of Cryosorbers in LHC

Complementary  
information

- The cryosorbers installed onto the **back of the BS** provide the required capacity and pumping speed for H<sub>2</sub>. They are located in cryoelements operating with 4.5 K cold bores
- The cryosorbers installed in D2, D3, D4, Q4, Q5 and Q6 of the LSS require a **regeneration** during the shutdown for removing the H<sub>2</sub>
- During normal operation of the LHC machine, a regeneration is not foreseen
- The cryosorber is regenerated at ~ 80 K
- While regenerating, the beam is OFF and the BS should be warmed up to more than 80 K and the CB held at more than 20 K (emptying cold mass)
- While the H<sub>2</sub> is liberated from the cryosorbers, it is pumped by an **external pumping system**.

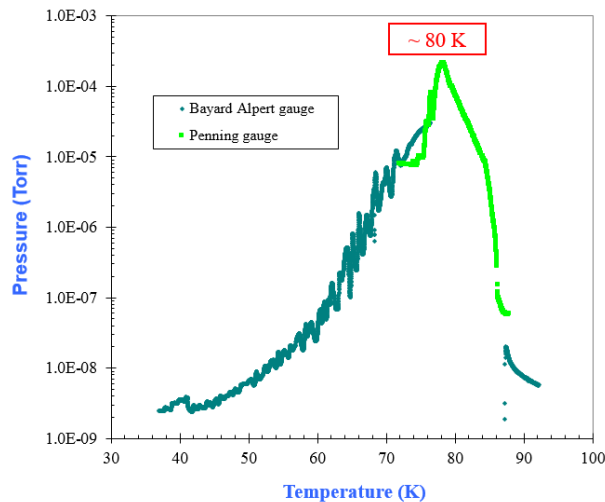

- Activation energy  $E_d = 236$  meV

$$\frac{E_d}{kT_p^2} = \frac{1}{\tau \beta} \exp\left(-\frac{E_d}{kT_p}\right)$$

V. Baglin *et al.* EPAC'04, Luzern 2004.

# 4. He leaks in cold systems

# He leak rate with risk of quench

Complementary information

- 1 year of operation ~ 150 days

Helium leak rate above  $5 \cdot 10^{-7}$  Torr.l/s shall be detected to avoid the risk of a quench

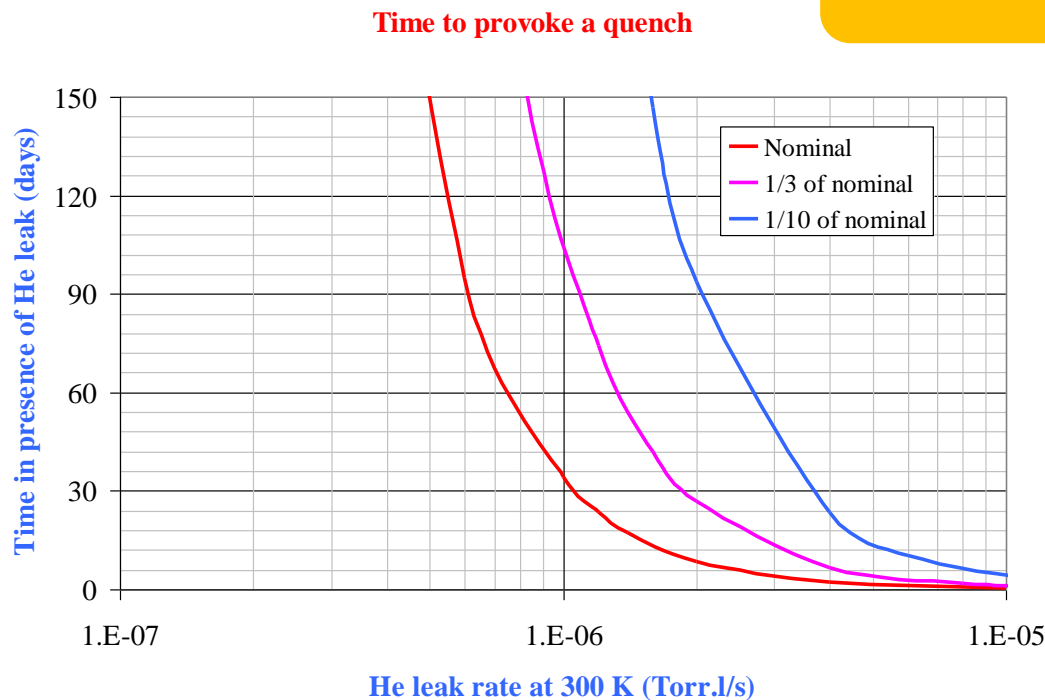

V. Baglin, Vacuum 81 (2007) 803-807

- Lower leak rate :  
Require a pumping of the beam tube on the yearly basis (cold bore  $> \sim 4$ K)
- Larger leak rate will provoke a magnet quench within :  
30 to 100 days beam operation for He leak rate of  $10^{-6}$  Torr.l/s  
A day of beam operation for He leak rate of  $10^{-5}$  Torr.l/s