

# High Power Proton LINACs

## Part 1



JOINT UNIVERSITIES  
ACCELERATOR SCHOOL

**Sébastien BOUSSON**

CNRS/IN2P3

Pôle Accélérateurs

IJCLab

bousson@ipno.in2p3.fr



(New Laboratory in Orsay issued from the merging of IPNO, LAL, CSNSM, IMNC and LPT)

**JUAS, Archamps, 13th March 2020**



## Acknowledgment

- Relies on preceding lectures, and particularly on Alex Mueller's course at previous JUAS
- Selected information with some emphasis on applications according to personal taste
- Some of the material was developed with Jean-Luc Biarrotte (IPN Orsay) for a seminar on superconducting cavities



## PART 1

- ➡ « Definition » of a High Power Proton LINAC (HPPL) and range of applications
- ➡ HPPL for neutron source
- ➡ HPPL for Radioactive Ion beams production
- ➡ HPPL for Nuclear waste treatment

## PART 2

- ➡ Superconducting cavities for HPPL : basics, advantages, performances overview and technological challenges



# Why high power proton accelerators ?

**Secondary Beams** produced by a **high energy proton** in a target  
5 applications in fundamental and applied Research

*S Nagamiya JAERI & KEK Joint Project*

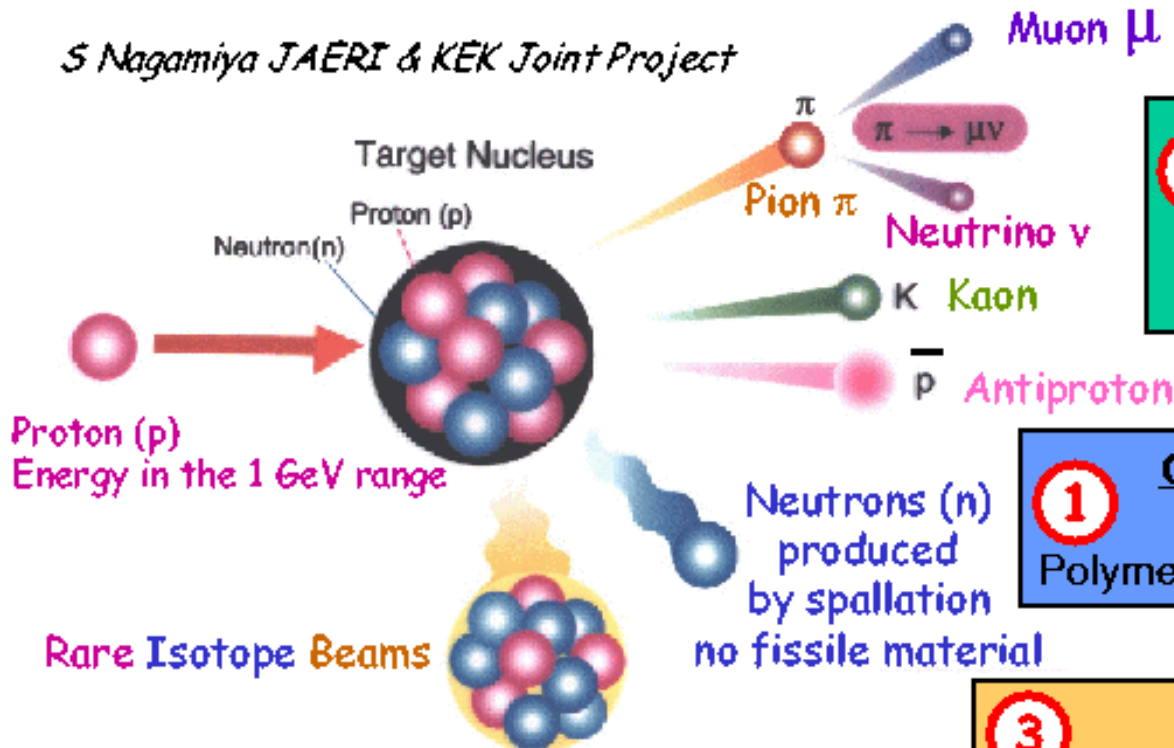

**5 Particle Physics**  
 $\mu$  colliders  
 $\mu$  Storage Rings  
( $\nu$  factories)

**1 Condensed Matter Study**  
Neutron probe  
Polymers, Fractals, Magnetism, Biology

**3 Transmutation**  
of long-lived radioactive wastes

**4 Technical Irradiation Tool**  
Tests of material

**2 Nuclear Physics**  
Beams of short-lived elements  
super heavy elements



# Specification for a High Power Proton Accelerator (HPPA)

	<b>R.I.B.</b>	<b><math>\nu</math>&amp;<math>\mu</math></b>	<b>Neutrons</b>	<b>Transmutation</b>
	(EURISOL)	(CERN)	(ESS)	(DEMO→Industriel)
$\hat{I}_{mA}$	<b>0.1→30</b>	<b>10</b>	<b>30→100</b>	<b>10→100</b>
$\langle I \rangle_{mA}$	<b>0.1→5</b>	<b>2</b>	<b>1→4</b>	<b>10→40</b>
$E_{GeV}$	<b>0.02→1-2</b>	<b>2</b>	<b>1→1.3</b>	<b>0.6-1</b>
<b>D.C.</b>	<b>100%</b>	<b>20%</b>	<b>6%</b>	<b>100%</b>
$\langle P \rangle_{MW}$	<b>0.1→5</b>	<b>4</b>	<b>1→5</b>	<b>6 → 40</b>

**HPPA: Power ranging typically from 100 kW so several MW**



# Particle accelerator main components & where HPPA is specific

schematic  
view



An accelerator is composed of the following main sub-systems:

- a source of charged particles:  $e^-$ ,  $p^+$ , heavy ions; special case:  $e^+$  & anti-protons
- accelerating elements  
*electrostatic columns* or *radiofrequency cavities* which provide the *electric fields* giving the energy to the particle (beam)
- beam guiding elements  
mainly magnetic, in order to maintain (*focus*) the beam on the wanted *trajectory* and to provide the *orbit* in the case of a *circular* machine
- as most important ancillary systems vacuum and beam diagnostics  
high vacuum is needed to avoid perturbation of the beam by *collisions with residual gas*, and beam diagnostics for the *monitoring of the beam trajectories*
- the user installation  
(complex) experimental set-ups including *targets, spectrometers, detectors*  
special case: *secondary beams* produced by a nuclear reaction (e.g.: neutrons) or an electromagnetic process (e.g.: photons by Bremsstrahlung/synchrotron Rad.)



## Classical Dynamics

$$W < E_0$$

In this case, the energy of the particle is purely kinetics:

$$E = \frac{1}{2} m_0 v^2$$

The particle momentum is

$$p = m_0 v$$

## Relativistic Dynamics

$$W \geq E_0$$

$$E = E_0 + W$$

$$E = mc^2 \quad E_0 = m_0 c^2$$

$$m = \gamma m_0 \quad E = \gamma E_0$$

$$\gamma = \frac{1}{\sqrt{1 - \beta^2}} \quad \beta = \frac{v}{c}$$

And:

$$p = mv \quad E^2 = E_0^2 + p^2 c^2$$

Ultra-relativistic case  $W \gg E_0$

$$\beta \approx 1 \quad v \approx c$$



# Different accelerator types

	Kinetic energy W	
	Electrons	Protons/ions
Electrostatic Van de Graaf & Tandems		20-35 MeV (Vivitron)
Betatron	10-300 MeV	
Microtron	25-150 MeV	
Cyclotron		10-100 MeV
Synchro-cyclotron		100-750 MeV
Synchrotron	1-10 GeV	1-1000 GeV
Storage ring	1-7 GeV (ESRF)	
Collider ring	10-100 GeV (LEP)	1-7 TeV (LHC)
Linacs	20 MeV-50 GeV (SLC)	50-800 MeV (LAMPF)
Linear collider	50-1000 GeV (TESLA)	

At PSI: p+ of 600 MeV, 2,2 mA

Total Energy (E) = Rest energy (E<sub>0</sub>) + Kinetic Energy (W)



$$= E_0 + W$$



$$E_0 = m_0 c^2 \rightarrow$$

electron E<sub>0</sub> = 0,511 MeV  
 protons E<sub>0</sub> = 938 MeV





## RF Linacs compared to other accelerator types

- In DC accelerators the energy gain is limited by the maximum applied voltage, **which is limited by electric breakdown.**
- In RF accelerators (linacs, synchrotrons, cyclotrons) the final energy can exceed the maximum voltage, which can be applied repeatedly to the beam. **The final energy is limited only by economics.**
- Synchrotrons are limited to low beam currents **by beam instabilities** associated with the repetitive cycling of the beam from turn to turn through unavoidable focusing lattice errors.
- Cyclotrons are not pulsed but are limited to low beam currents by weak focusing and same inherent circular machine instabilities.
- Linacs can deliver high beam currents because they can provide strong focusing to confine the beam and are not subject to circular machine instabilities.



**In summary** : Linacs are capable of delivering beams with high energy, high intensity and good beam quality (small emittance)

- Maximum energy not limited by electric breakdown.
- Strong focusing can be provided.
- Single pass device means beam is not subject to repetitive error conditions which cause destructive resonances as in circular machines.
- No power loss from synchrotron radiation for electron linacs.
- Natural orbit is a straight line making injection and extraction easier.
- No limit to duty factor.



# Installed or projected HPPA

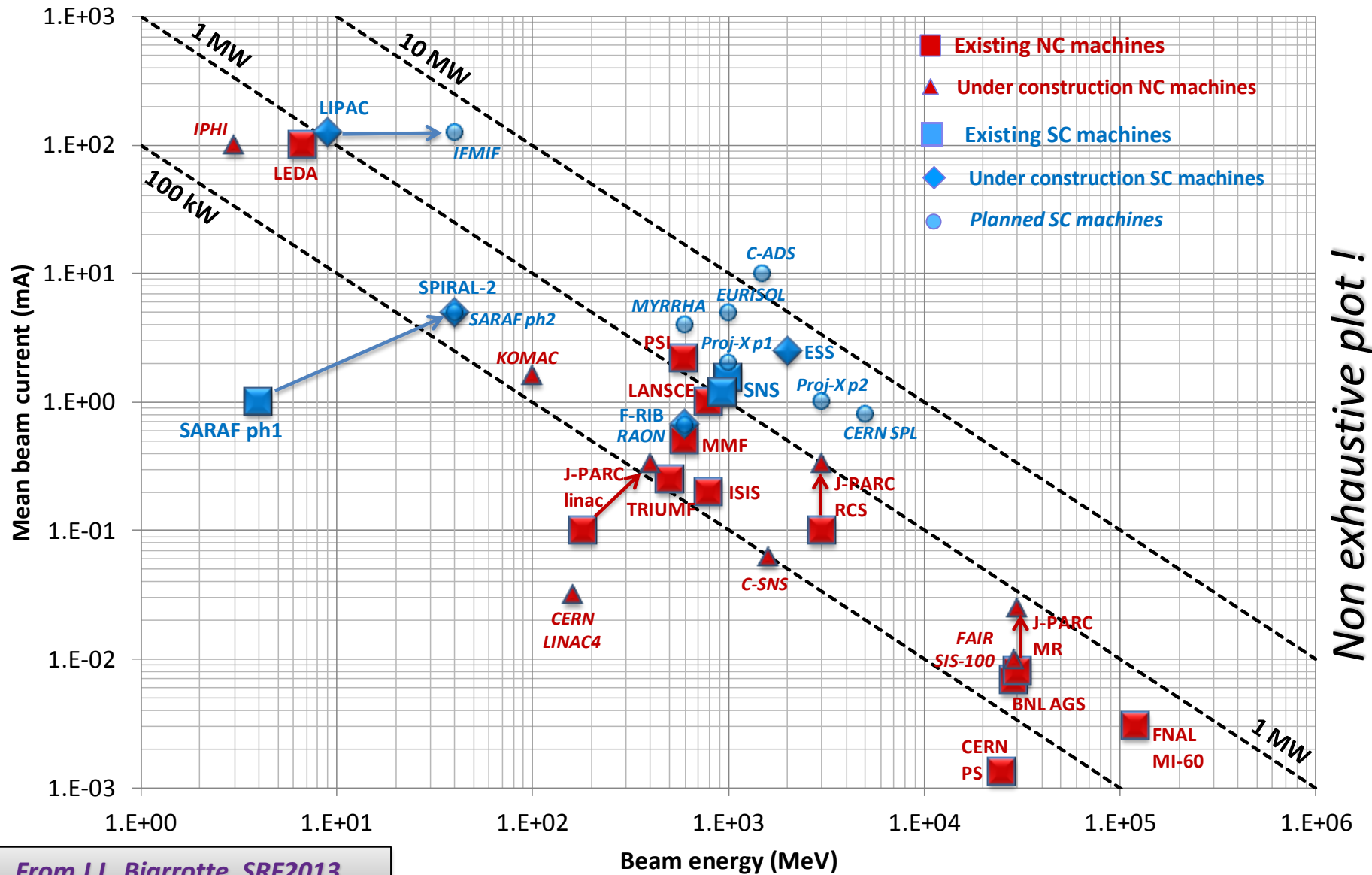

Non exhaustive plot !

From J.L. Biarrotte, SRF2013

Sébastien Bousson, High Power Proton Linac, JUAS, Archamps, 13th March 2020





High Power Proton Accelerator used  
for neutron sources produced by spallation

## Neutron Scattering

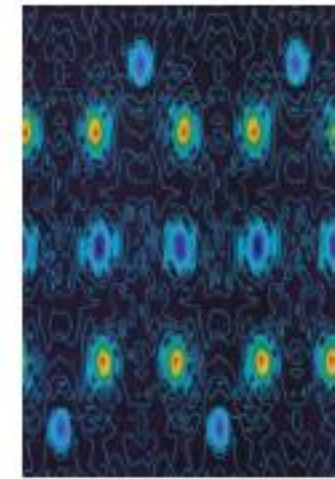
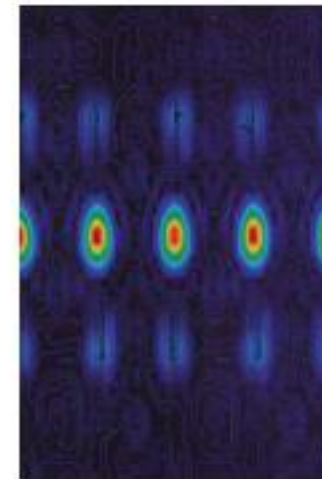
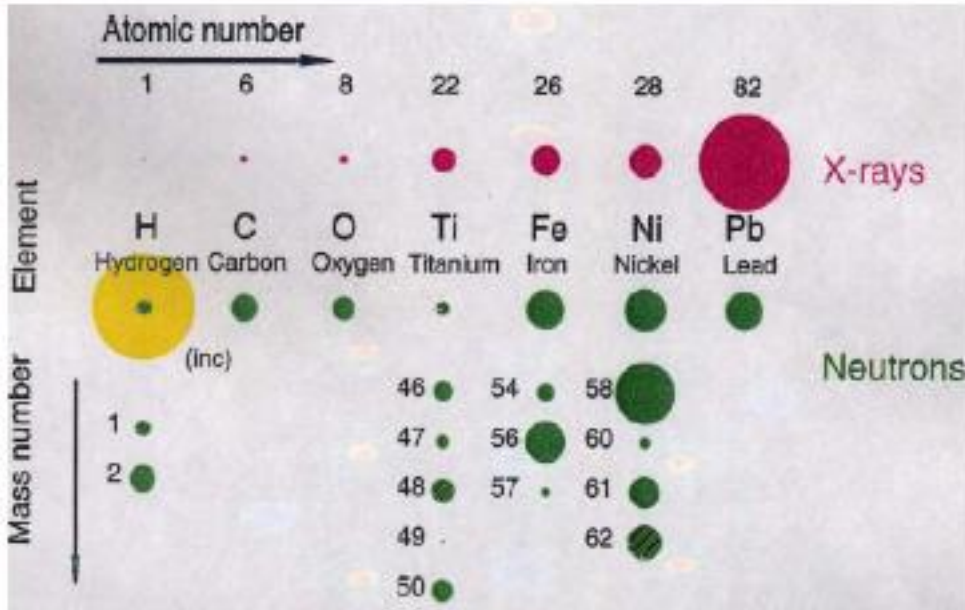

— Li  
— O  
— Mn  
— O  
— Li

Material for Li-battery seen by X rays (left) and Neutrons (right)

**T. Kamiyama, et al.**

X-rays interact with electrons.  
 → X-rays see high-Z atoms.  
 Neutrons interact with nuclei.  
 → Neutrons see low-Z atoms.



# Condensed matter study: why neutrons ?

## Hen Egg-White Lysozyme

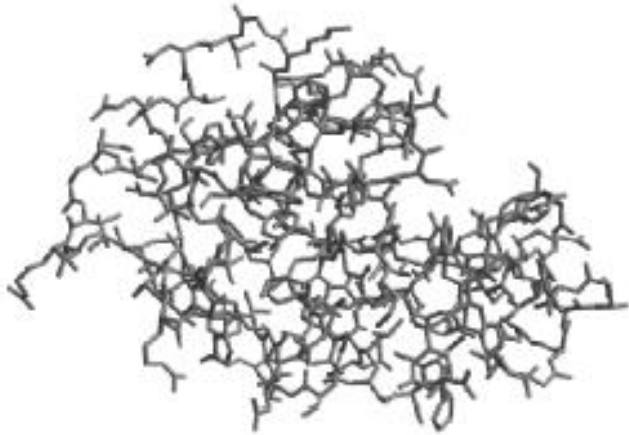

X-rays

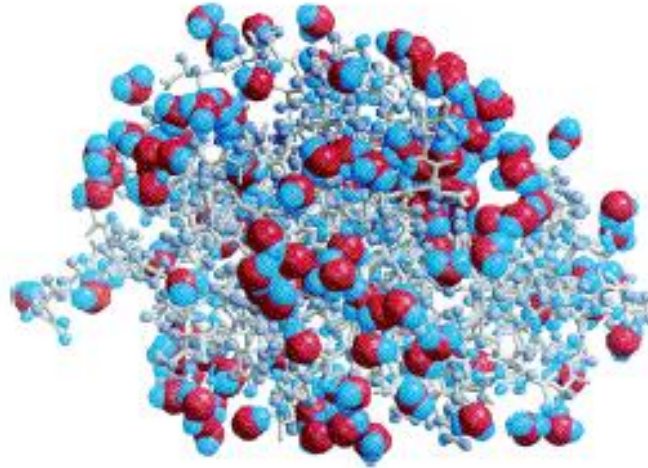

Water molecules  
Observed with  
neutrons

**N. Niimura, et al.**

Neutrons

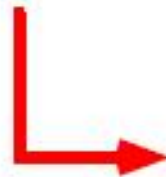

From structure to function

Protein

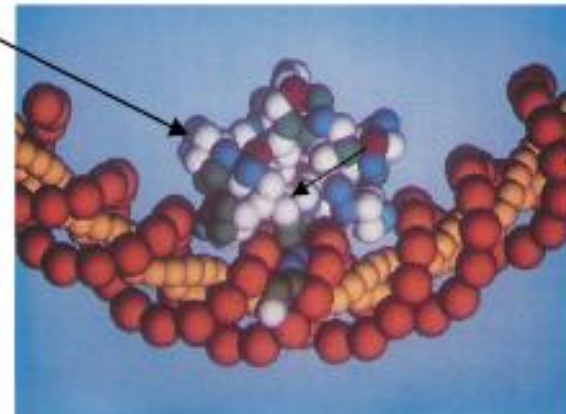

DNA

A protein  
molecule  
moving along  
the DNA chain



# Condensed matter study: why neutrons ?



Courtesy of PSI



# Condensed matter study: why neutrons ?

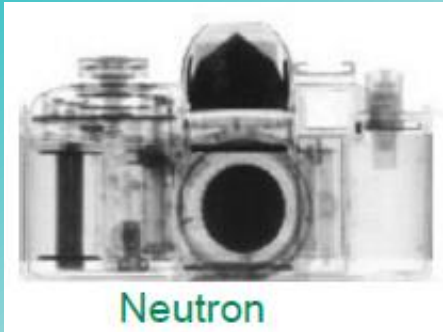

Neutron



X-ray

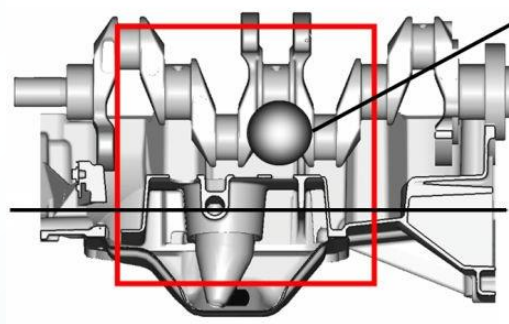
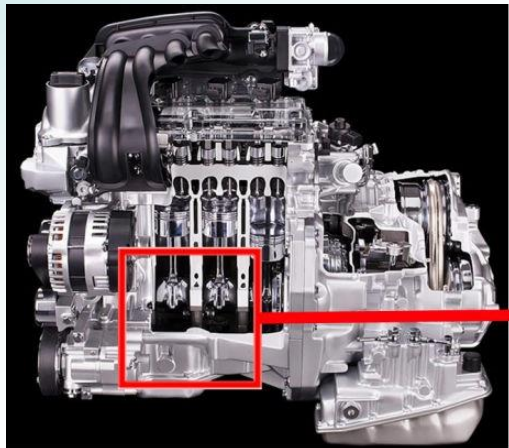
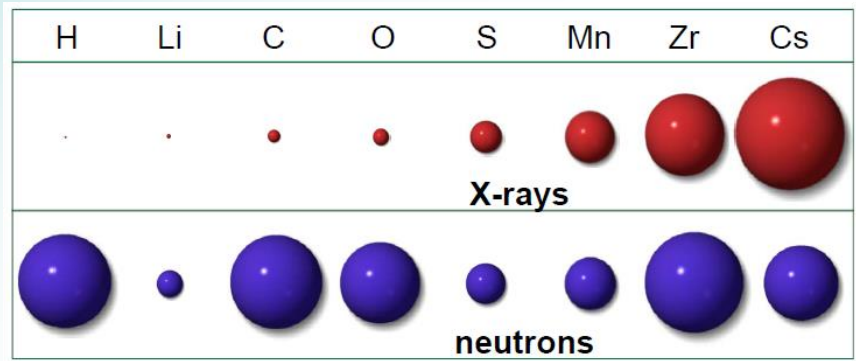

Oil Filter  
Crankshaft  
Oil Level



Copyright @ Nissan





J-PARC : Japan Proton Accelerator Research Complex (construction achieved, close to commissioning completion)



# J-PARC (Japan) : Accelerator complex

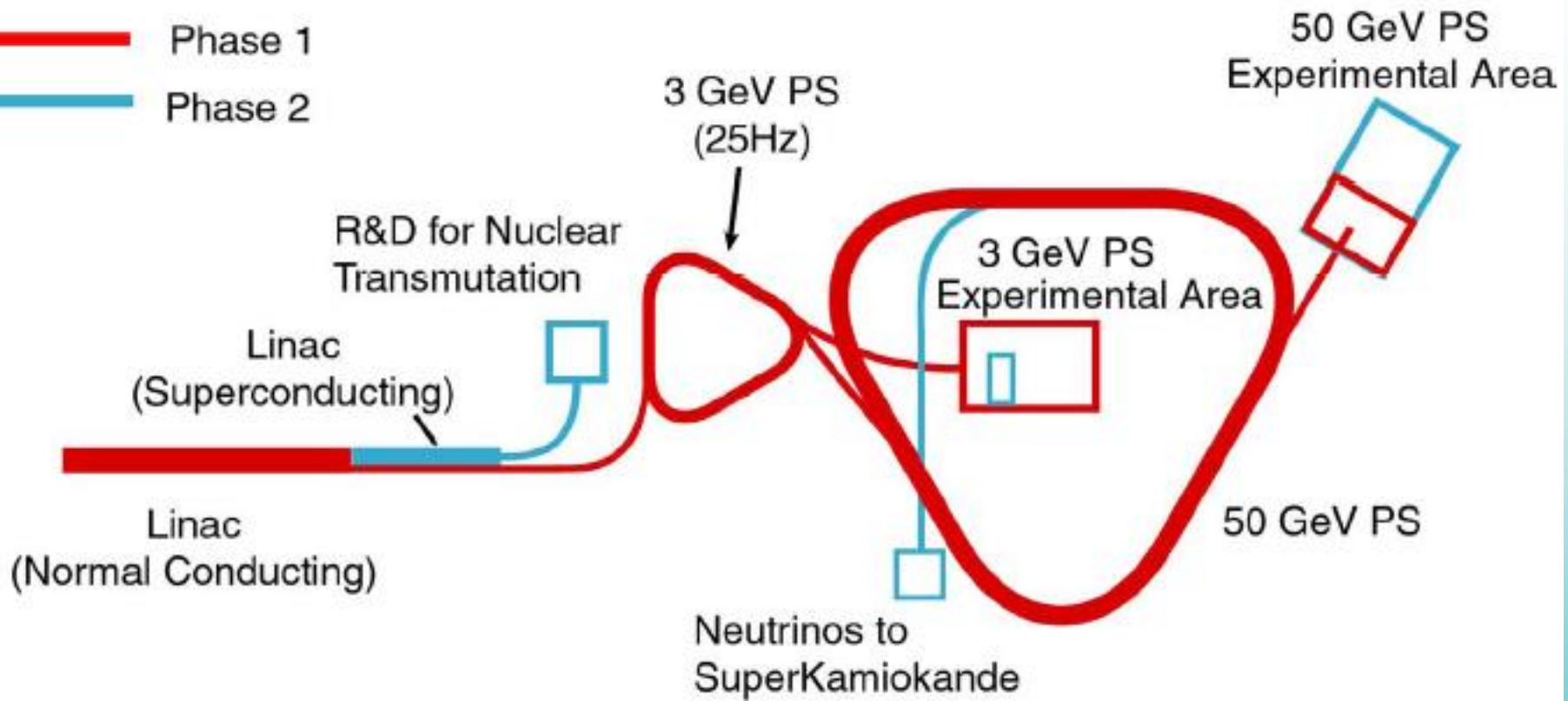

- Phase 1 + Phase 2 = 189 billion Yen (= \$1.89 billion if \$1 = 100 Yen).
- Phase 1 = 133.5 billion Yen for 6 years (= 2/3 of 189 billion Yen).
- Construction budget does not include salaries.



# J-PARC (Japan) : Accelerator complex

## Secondary particle produced at J-PARC:

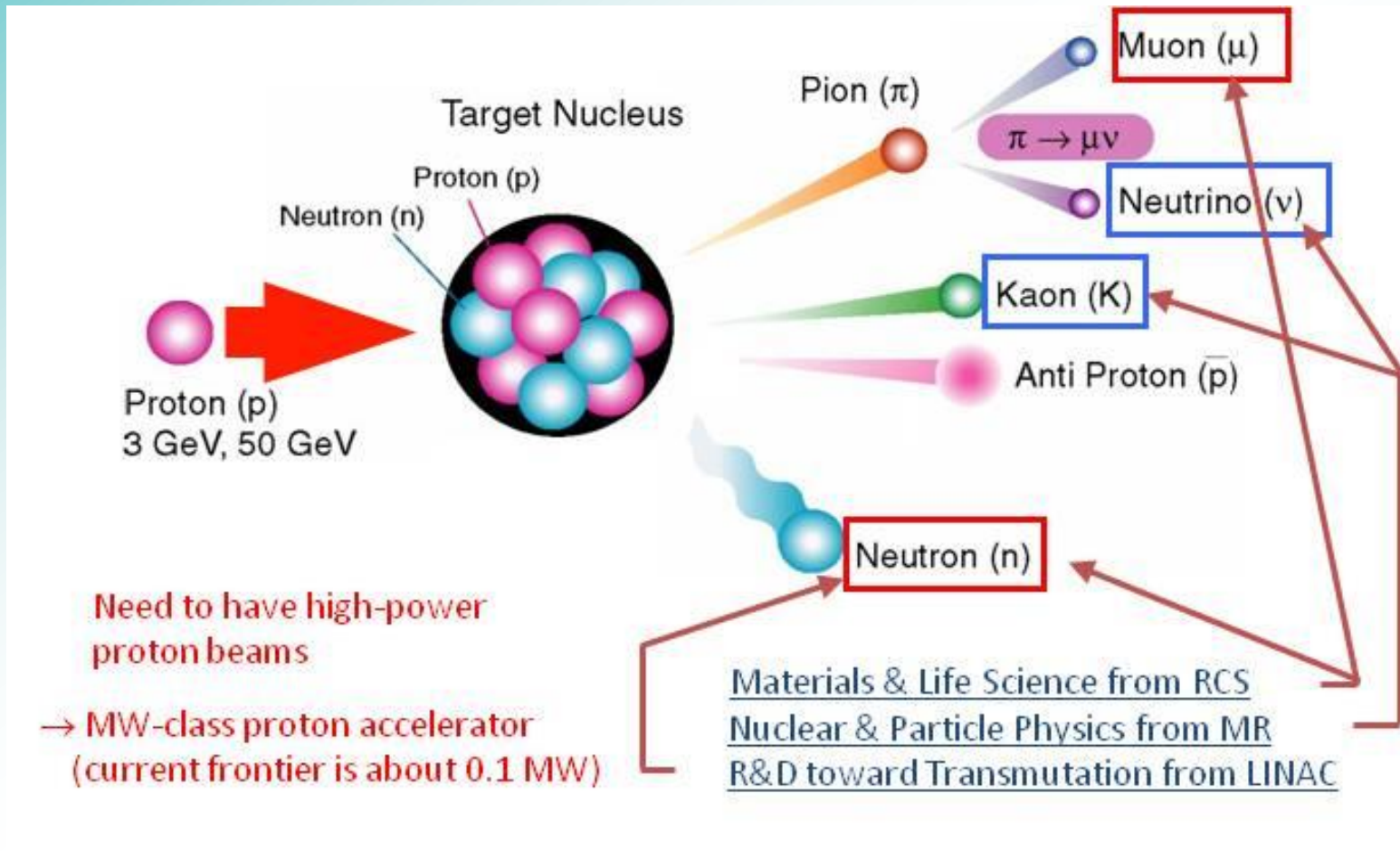



# J-PARC: Overview

Joint Project between KEK and JAEA

Materials and Life Science Experimental Facility (MFL)

Hadron Experimental Facility

Nuclear Transmutation

Multi-Purpose Facility

500 m

Neutrino Experimental Facility

Linac 181 MeV (400MeV)

3 GeV Rapid Cycling Synchrotron (RCS) (25 Hz, 1MW)

50 GeV Main Ring Synchrotron (MR) (0.75 MW)

J-PARC = Japan Proton Accelerator Research Complex



# J-PARC : Planning

## J-PARC Construction Schedule

Feb. 27 2006

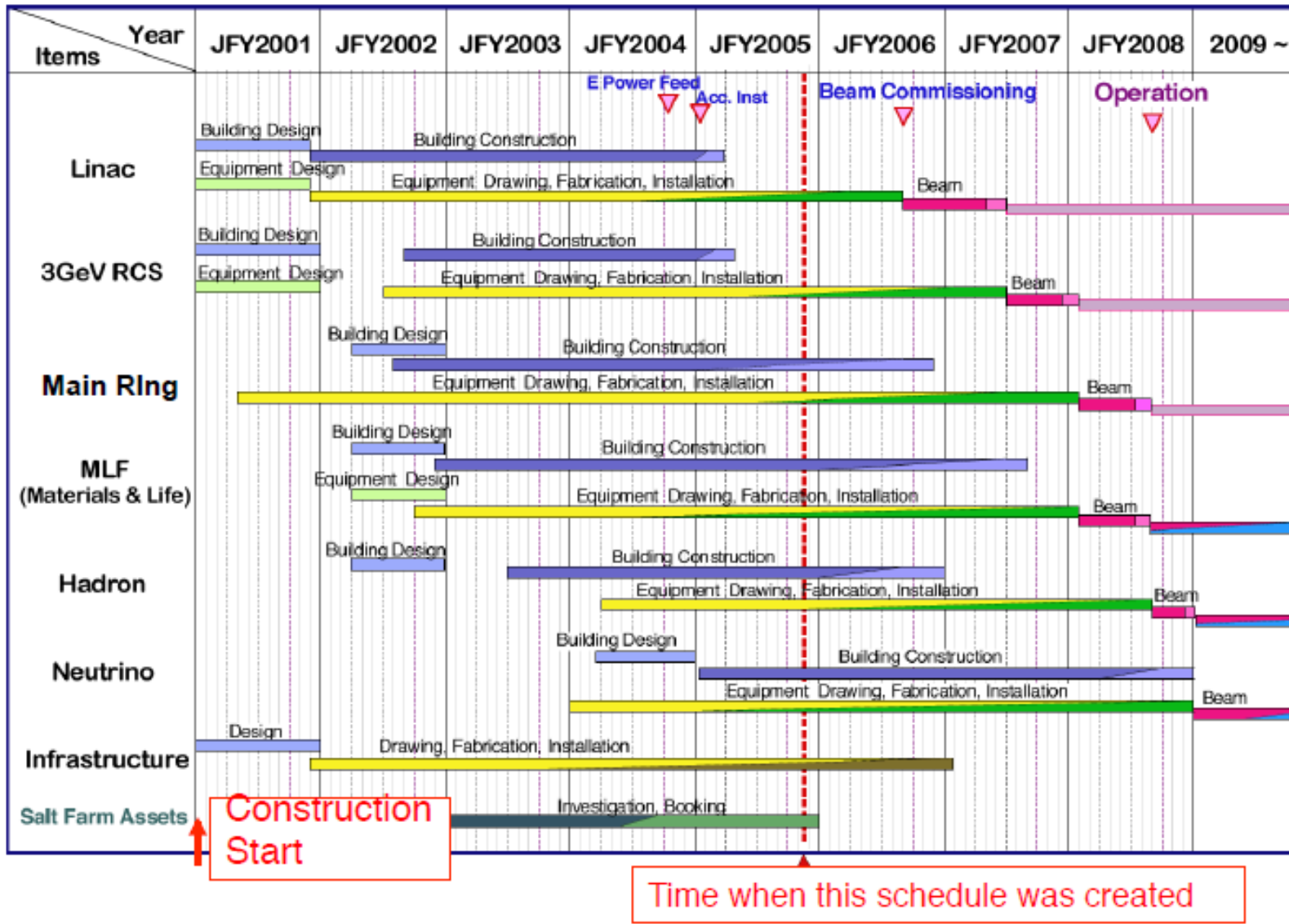



# J-PARC : Pictures

**Linac building**



December, 2003

**3 GeV building**





# J-PARC : Pictures

J-PARC Photo



November, 2006



# J-PARC : Pictures



onental  
ity





## History of beam commissioning

**2001** Construction started.

**2006** Linac beam commissioning started.

**2007** Linac beam energy of 181 MeV was achieved.  
RCS beam commissioning started.

RCS beam energy of 3 GeV was achieved.

**2008** MR beam commissioning started.

First proton beams reached to the neutron target.

MR beam energy of 30 GeV was achieved.

First proton beams reached to the Hadron target.

User operation of MLF started.

**2009** First proton beams reached to the Neutrino target.



# J-PARC : commissioning

## History of beam delivery to MLF

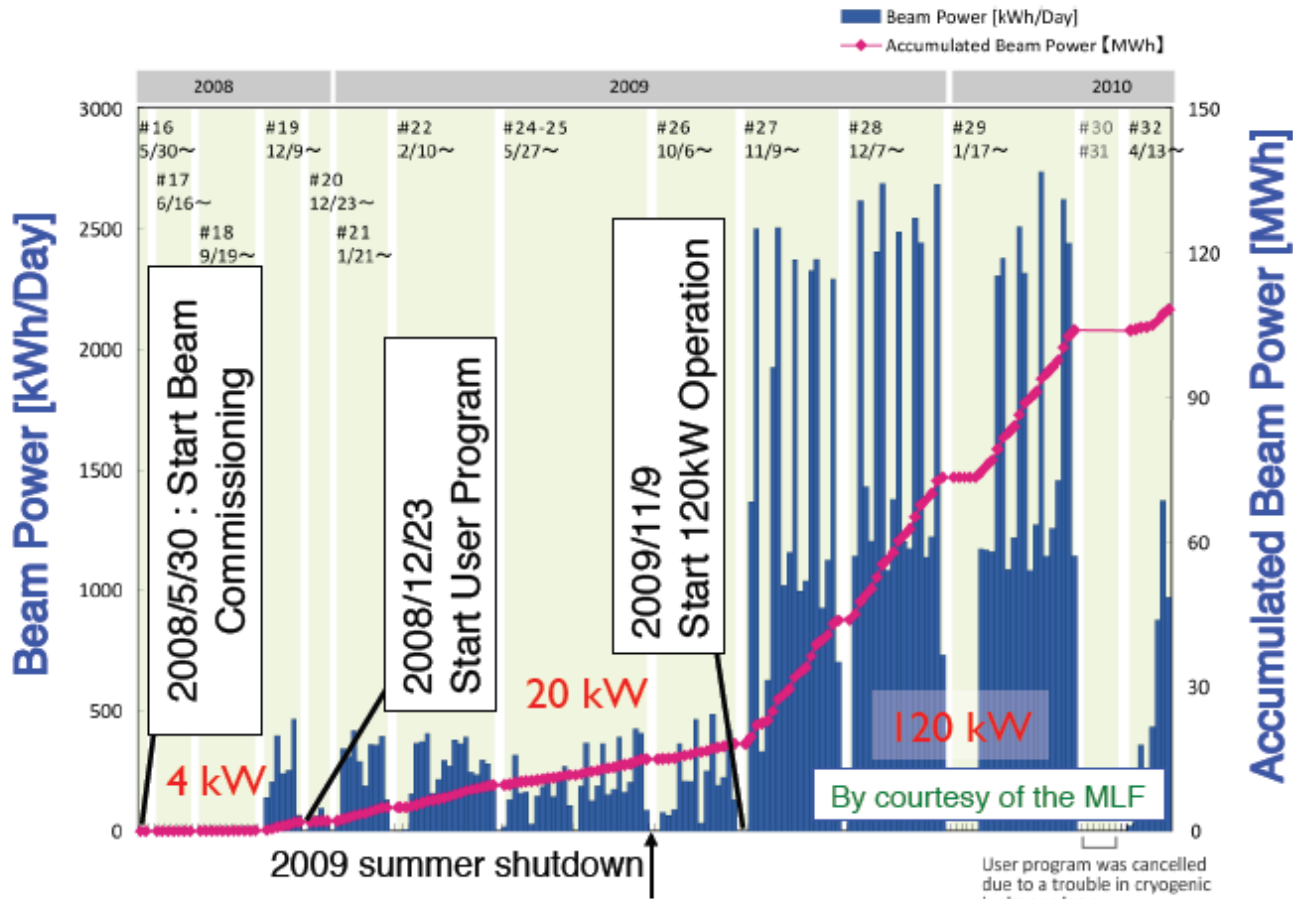

### Dec. 2010:

300 kW during 1 hour of beam power issued from the RCS

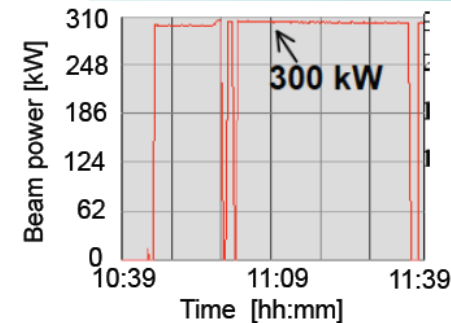

After the recovery of Linac-RFQ, high power operation of the RCS has become possible and 120 kW operation has started for the MLF users.

**Neutron beamline :** 12 beamlines are now under commissioning and open for users.

**Muon beamline:** The highest intensity beamline in the world with the 120 kW beam.

## 11 March 2011: M 9 Earthquake & consecutive Tsunami: damages to JPARC



Inside of underground tunnel immediately after the Earthquake



**Full power (1 MW in RCS, 330  $\mu$ A) achieved 27 Dec. 2015**



## Main Ring Beam Power History

- In the operation of Jan ~ May 2016, the beam power was mostly about **390 kW with  $2 \times 10^{14}$  protons per pulse**. The user operation of **415~425 kW** was successful in May 2016.

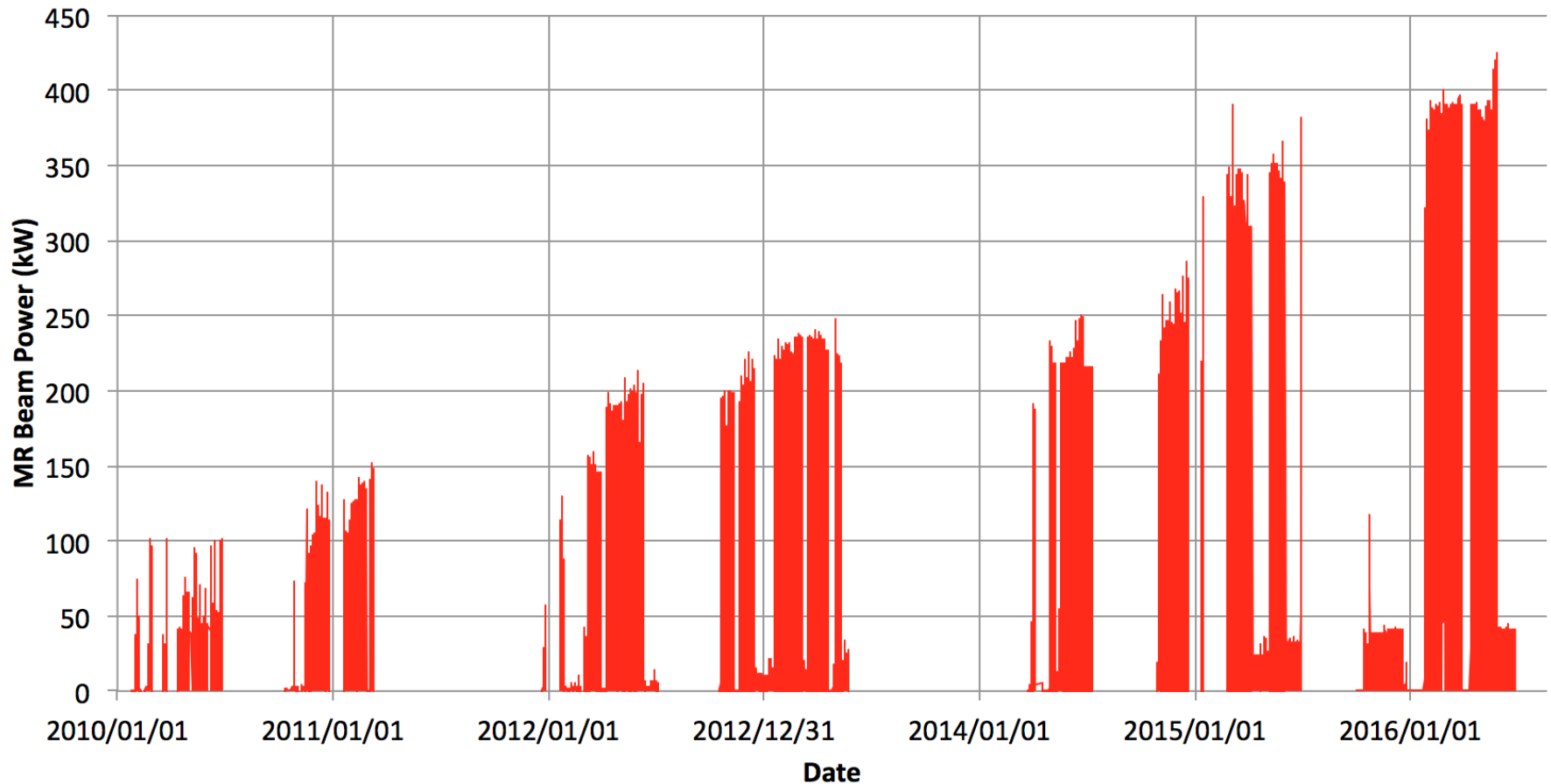



# J-PARC : Linac parameters

## Major Parameters

- Particles:  $H^-$
- Energy: 181 MeV  
(400 MeV for ACS, 600 MeV for SCC)
- Peak current: 30 mA (50 mA for 1MW at 3GeV)
- Repetition: 25 Hz (additional 25 Hz for ADS)
- Pulse width: 500  $\mu$ sec

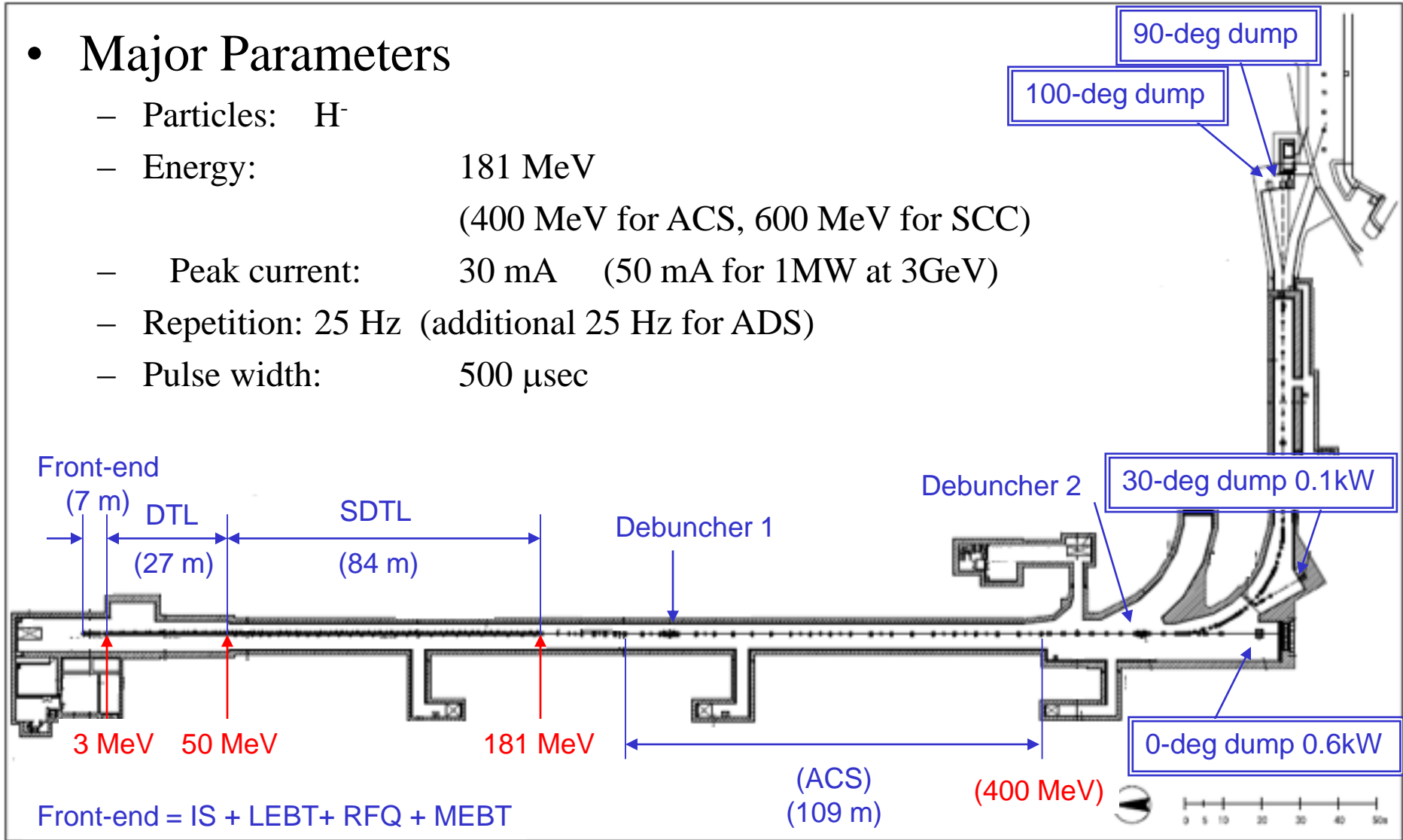



# J-PARC : Linac pictures



**RFQ**

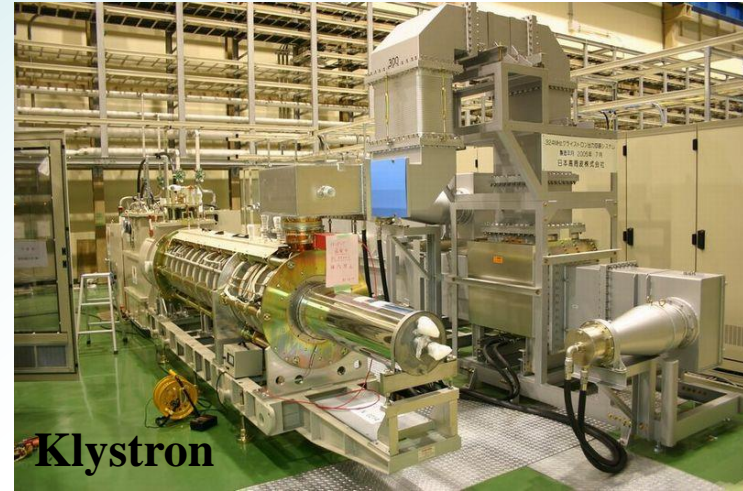

**Klystron**

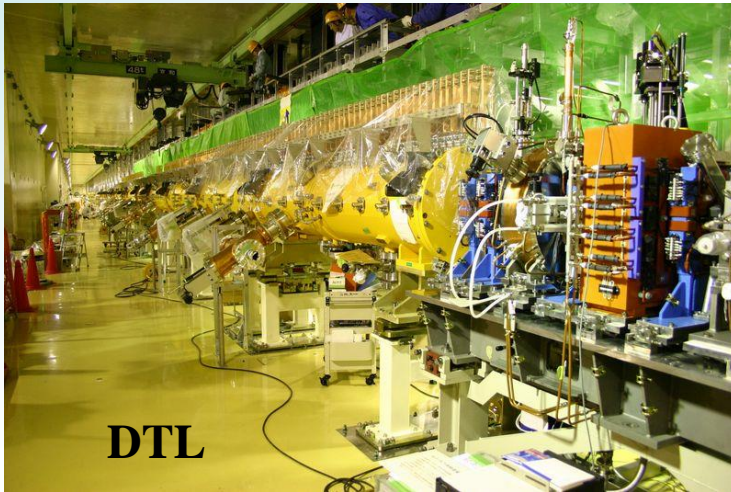

**DTL**

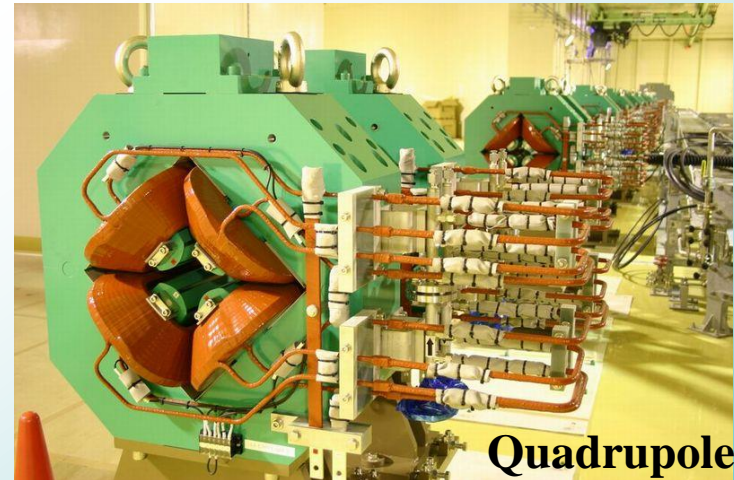

**Quadrupole**



# J-PARC : The SC Linac parameters

## Preliminary design of SC proton linac Design Parameters

Energy	400-600 MeV
Frequency	972 MHz
$\beta$	0.71-0.79
No. of Cell	9 cell/cavity
No. of Cavity	2 cavity/cryomodule
No. of Cryomodule	11 cryomodules
Length	57.7 m
Surface Peak Field	30 MV/m
Accelerating Field	9.7-11.1MV/m
Synchronous Phase	-30 deg
No. of Klystron	11 klystrons
Total RF Power	10 MW
Loaded Q	~500,000

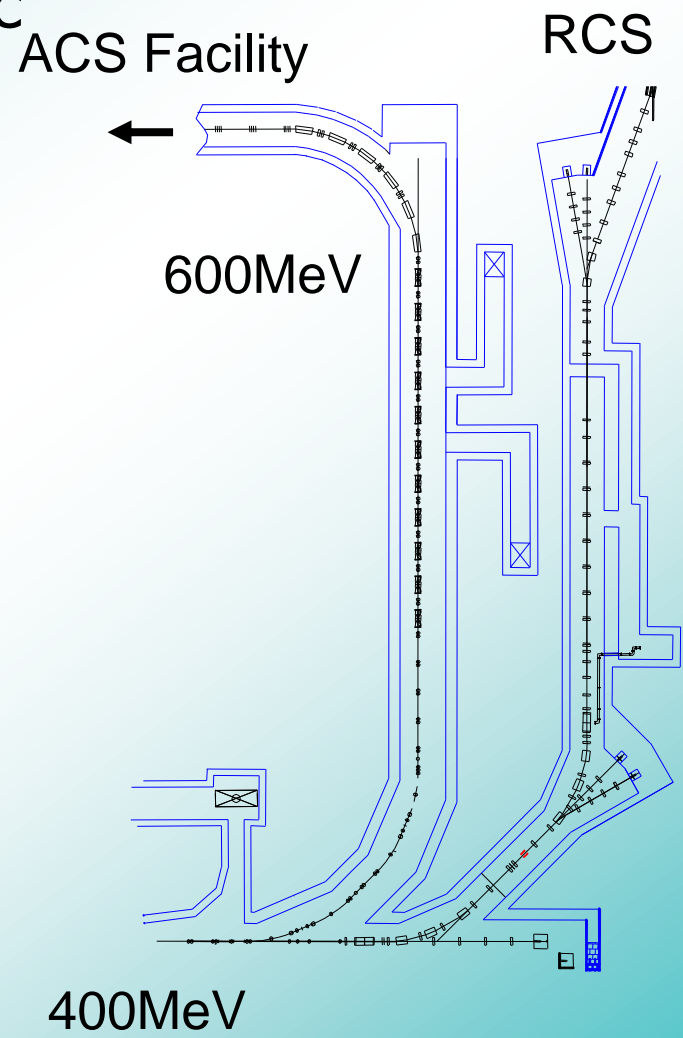

Amplitude and phase stability ( $\pm 1\%$  & 1deg) in pulsed operation



# J-PARC : The SC Linac cryomodule

- Two 9-cell elliptical cavities of  $\beta=0.725$  at 2K (972 MHz)
- Stiff structure for cavity and tuner to reduce Lorentz force detuning
- 80K thermal shield by LN<sub>2</sub> and 5K thermal intercept by LHe

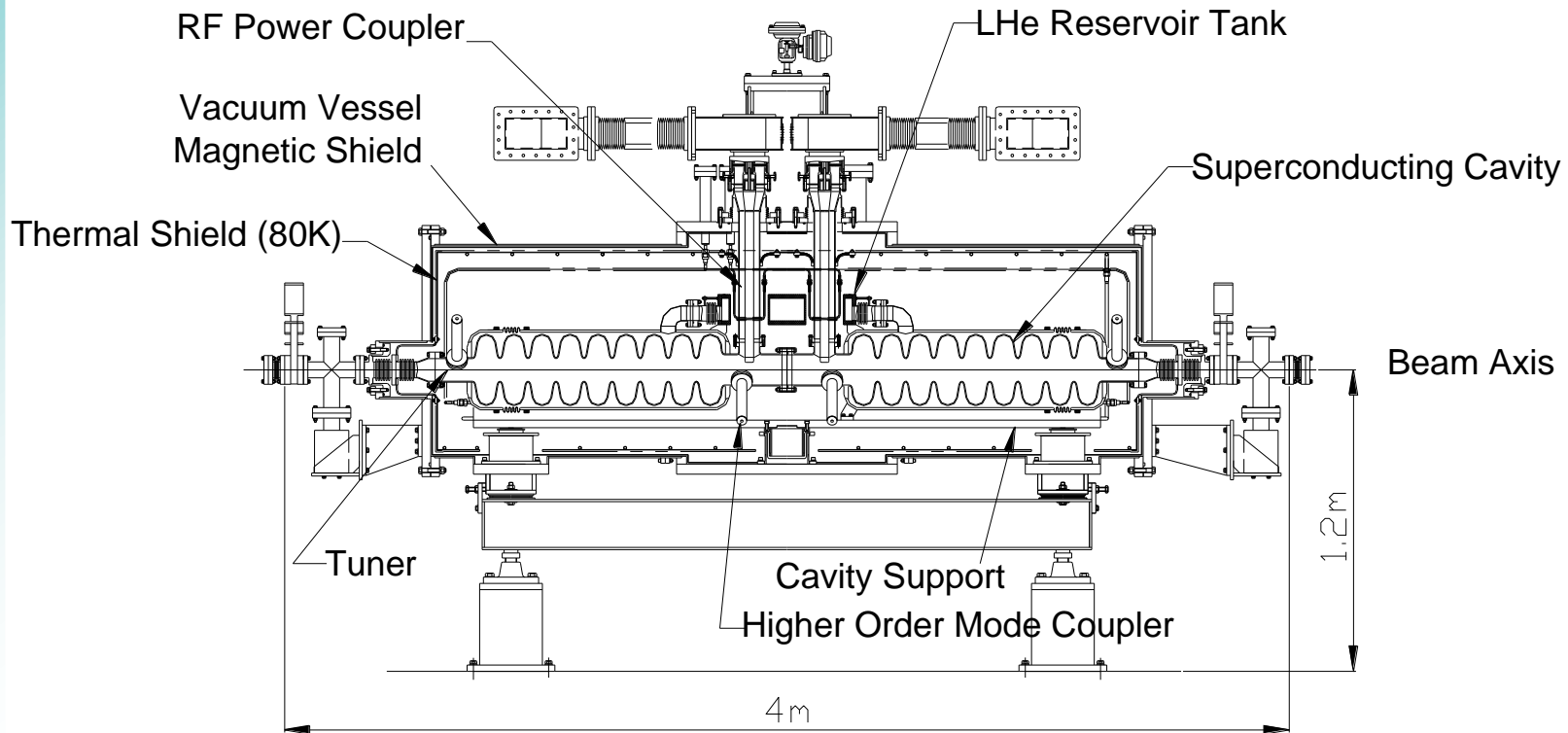





# J-PARC SC Linac : R&D on 972 MHz cryomodule

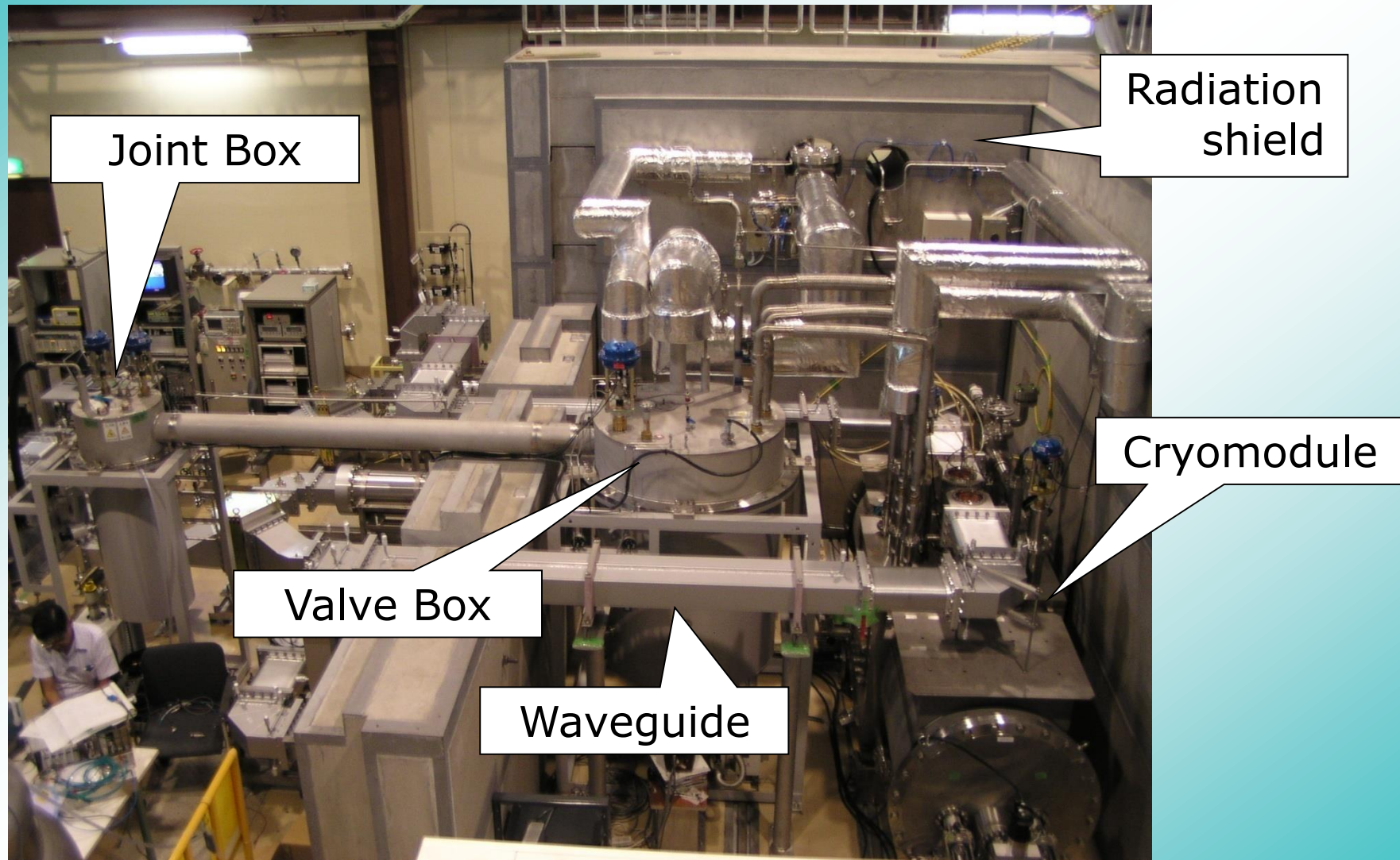



# J-PARC SC Linac : R&D on 972 MHz cryomodule

Cavity Phase for several pulses during  $\sim 1$ min  
(Eacc $\sim 10$  MV/m, Pulse length: 1ms, Repetition: 25Hz)

@2.1K

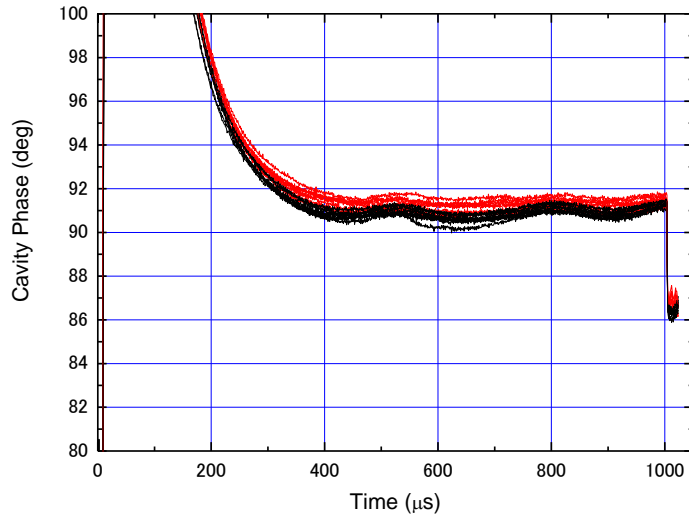

@4.2K

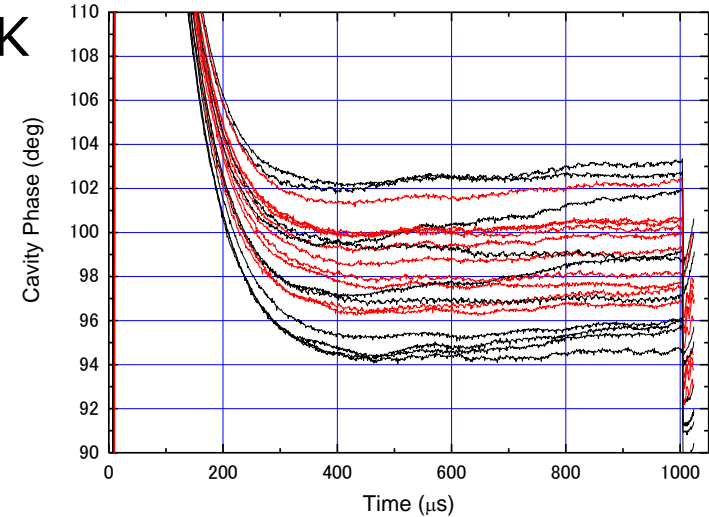

- Phase stability  $< \pm 1$  deg
- Changing slowly  
→ Control of LHe vessel pressure & automatic tuning system

- Phase stability  $< \pm 5$  deg
- Scattering significantly  
(Microphonics ?)  
(Bubbling of He ?)

Phase stability of  $\pm 1$ deg is realized in 2K operation, impossible at 4.2 K



## SNS : Spallation Neutron Source Oakridge, Tennessee, USA

(commissioning completed, operational phase)



# SNS : the US spallation neutron source



01-04517/arb

# SNS layout

## 1 Front End

(Lawrence Berkeley)

The front-end system produces pulsed beams of negative hydrogen ions.

## 2 Linac

(Los Alamos and Jefferson)

The accelerator increases the energy of the hydrogen ions to one billion electron volts, almost 90% the speed of light. The ions are transported to the accumulator ring, and as they enter the ring, their electrons are removed, which changes them into protons. This is the world's first superconducting proton accelerator.

## 3 Accumulator Ring

(Brookhaven)

Sixty times a second, the protons are ejected from the ring and delivered to the target.

### Key Facts

Funded By: U.S. DOE Office of Science

Total Cost: \$1.4 billion

Completion Date: 2006

Annual Operating Budget: \$150M est (2007)

## Target

(Oak Ridge)

The ejected protons bombard the target, which produces neutrons by the spallation process.

## Instrument Systems

(Argonne and Oak Ridge)

The neutrons are slowed to useful energies and are guided into the various instruments, where they are used for scientific experiments and industrial development.





# SNS : Main parameters

## Spallation Neutron Source Primary Parameters

Proton beam power on target	1.4 MW		
Proton beam kinetic energy on target	1.0 GeV		
Average beam current on target	1.4 mA		
Pulse repetition rate	60 Hz		
Protons per pulse on target	$1.5 \times 10^{14}$ protons		
Charge per pulse on target	24 $\mu$ C		
Energy per pulse on target	24 kJ	RTBT length	150 m
Proton pulse length on target	695 ns	Ion type (Ring, RTBT, Target)	proton
Ion type (Front end, Linac, HEBT)	H minus	Ring filling time	1.0 ms
Average linac macropulse H- current	26 mA	Ring revolution frequency	1.058 MHz
Linac beam macropulse duty factor	6 %	Number of injected turns	1060
Front end length	7,5 m	Ring filling fraction	68 %
Linac length	331 m	Ring extraction beam gap	250 ns
HEBT length	170 m	Maximum uncontrolled beam loss	1 W/m
Ring circumference	248 m	Target material	Hg
RTBT length	150 m	Number of ambient / cold moderators	1/3
		Number of neutron beam shutters	18
		Initial number of instruments	5



# SNS : Main parameters

## SNS Beam Evolution Parameters

	Front End		Linac				Ring					Unit
	IS/LEBT	RFQ	MEBT	DTL	CCL	SCL (1)	SCL (2)	HEBT	Ring	RTBT		
Output Energy	0.065	2.5	2.5	86.8	185.6	391.4	1000	1000	1000	1000	MeV	
Relativistic factor $\gamma$	0.0118	0.0728	0.0728	0.4026	0.5503	0.7084	0.875	0.875	0.875	0.875		
Relativistic factor $\beta$	1.00007	1.0027	1.0027	1.0924	1.1977	1.4167	2.066	2.066	2.066	2.066		
Peak current	47	38	38	38	38	38	38	38	9x10 <sup>4</sup>	9x10 <sup>4</sup>	mA	
Minimum horizontal acceptance <sup>g</sup>			250	38	19	57	50	26	480	480	$\pi$ mm mr	
Output H emittance (unnorm., rms)	17	2.9	3.7	0.75	0.59	0.41	0.23	0.26	24	24	$\pi$ mm mr	
Minimum vertical acceptance <sup>g</sup>			51	42	18	55	39	26	480	400	$\pi$ mm mr	
Output V emittance (unnorm., rms)	17	2.9	3.7	0.75	0.59	0.41	0.23	0.26	24	24	$\pi$ mm mr	
Minimum longitudinal acceptance			4.7E-05	2.4E-05	7.4E-05	7.2E-05	1.8E-04		19/□		$\pi$ eVs	
Output longitudinal rms emittance		7.6E-07	1.0E-06	1.2E-06	1.4E-06	1.7E-06	2.3E-06		2/□		$\pi$ eVs	
Controlled beam loss; expected	0.05 <sup>a</sup>	N/A	0.2 <sup>b</sup>	N/A	N/A	N/A	N/A	5 <sup>c</sup>	62 <sup>d</sup>	58 <sup>e</sup>	kW	
Uncontrolled beam loss; expected	70	100 <sup>f</sup>	2	1	1	0.2	0.2	<1	1	<1	W/m	
Output H emittance (norm., rms)	0.2	0.21	0.27	0.33	0.39	0.41	0.41	0.46	44	44	$\pi$ mm mr	
Output V emittance (norm., rms)	0.2	0.21	0.27	0.33	0.39	0.41	0.41	0.46	44	44	$\pi$ mm mr	

Note a) corresponding to 27% chopped beam  
 b) corresponding to 5% chopped beam  
 c) beam loss on the transverse and momentum collimators  
 d) including total 4% of beam escaping foil and 0.2% beam loss on collimators  
 e) including 4% beam scattered on the target window  
 f) corresponding to 20% beam loss averaged over RFQ length  
 g) full acceptance without collimation



# SNS : Planning

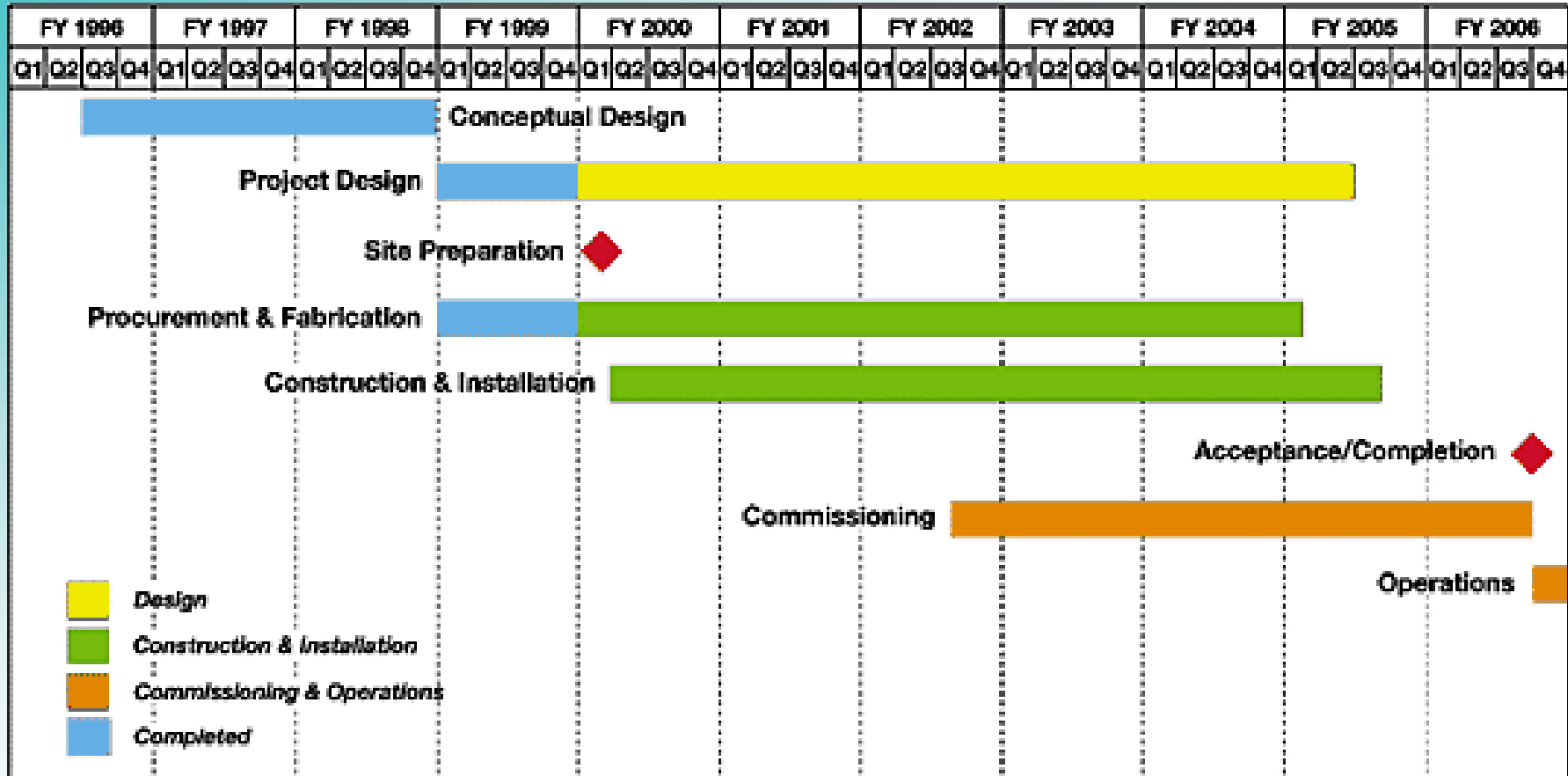

Commissioning of the accelerator at low power (10 kW) achieved in May 2006. Next phase is the power ramping up to 1.4 MW. Present status is around 1 MW





# SNS : aerial views



End 1999



End 2000



# SNS : aerial views





# SNS : Linac pictures

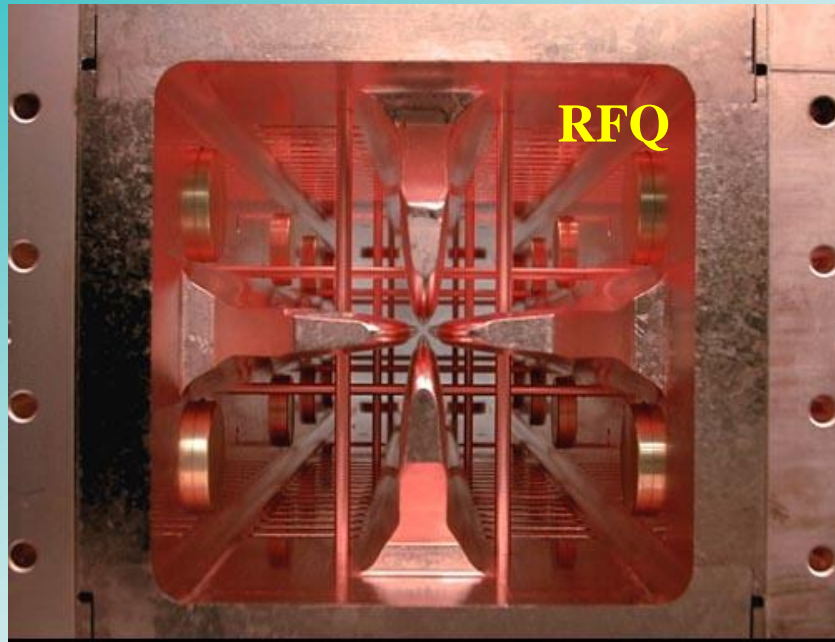



# SNS : Linac pictures : SC cryomodules

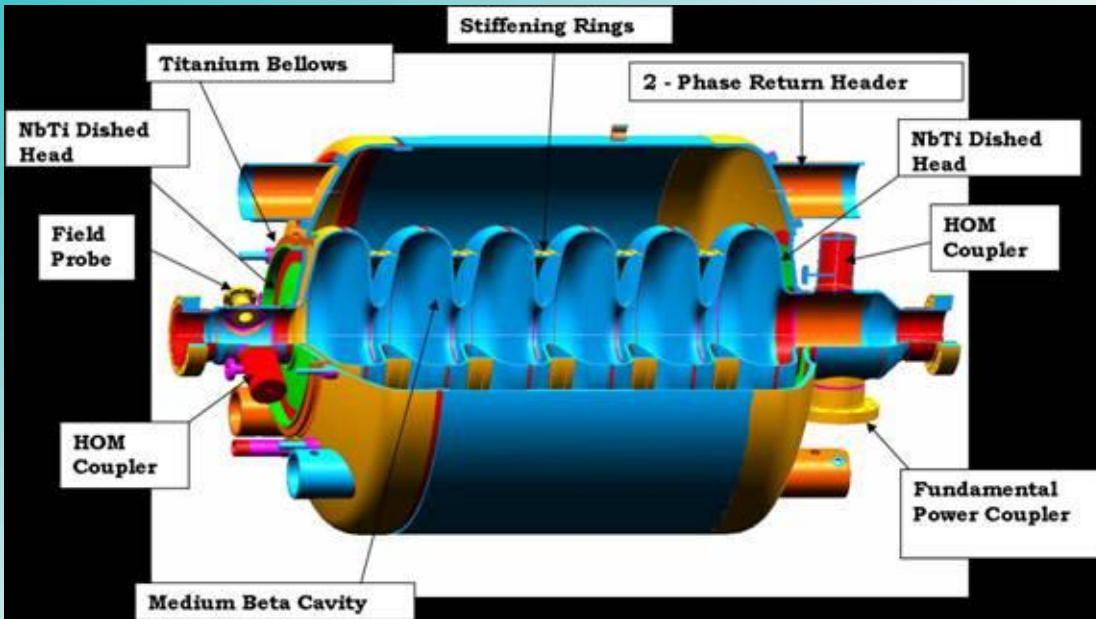



# SNS : Design vs achieved parameters (oct. 2009)

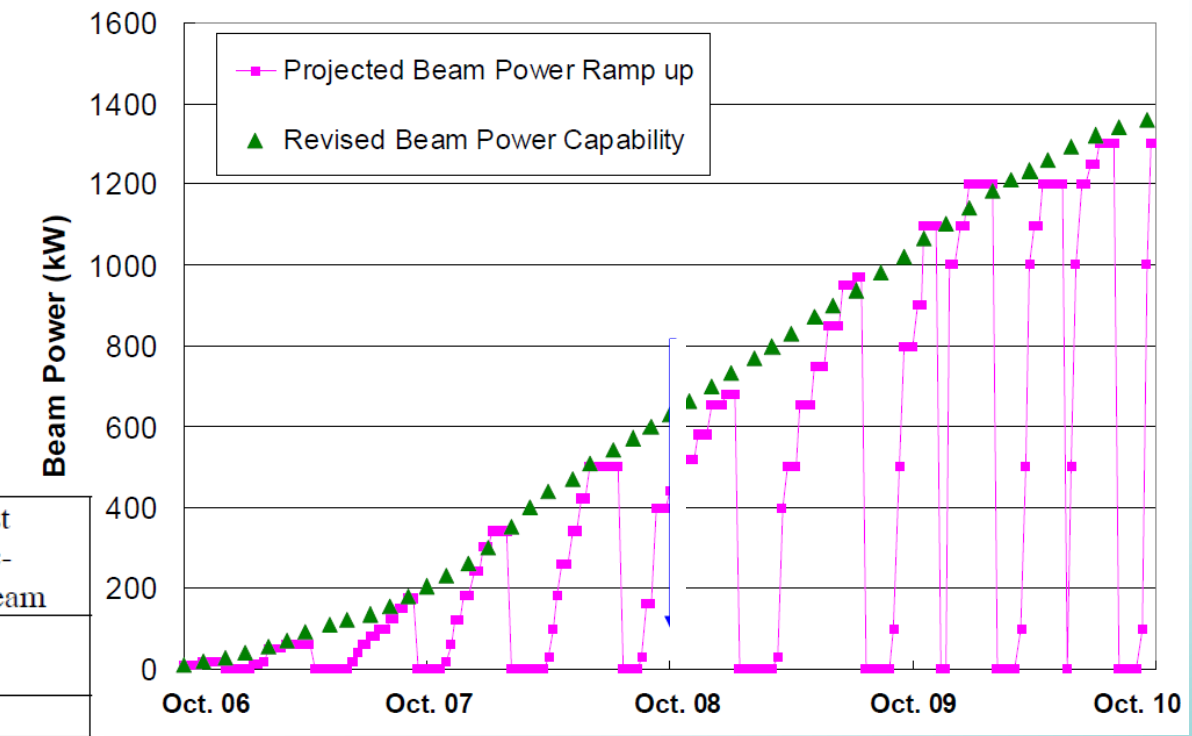

Parameters	Design	Highest Production Beam
Beam Energy (GeV)	1.0	0.93 + 0.01
Peak Beam current (mA)	38	40
Average Beam Current (mA)	26	24
Beam Pulse Length (ms)	1000	670
Repetition Rate (Hz)	60	60
Beam Power on Target (MW)	1440	<b>1.01</b>
Linac Beam Duty Factor (%)	6	4.0
Beam intensity on Target (protons per pulse)	$1.5 \times 10^{14}$	$1 \times 10^{14}$
SCL Cavities in Service	81	80



SNS : 1.4 MW (nominal power) in 2013

# SNS Power History

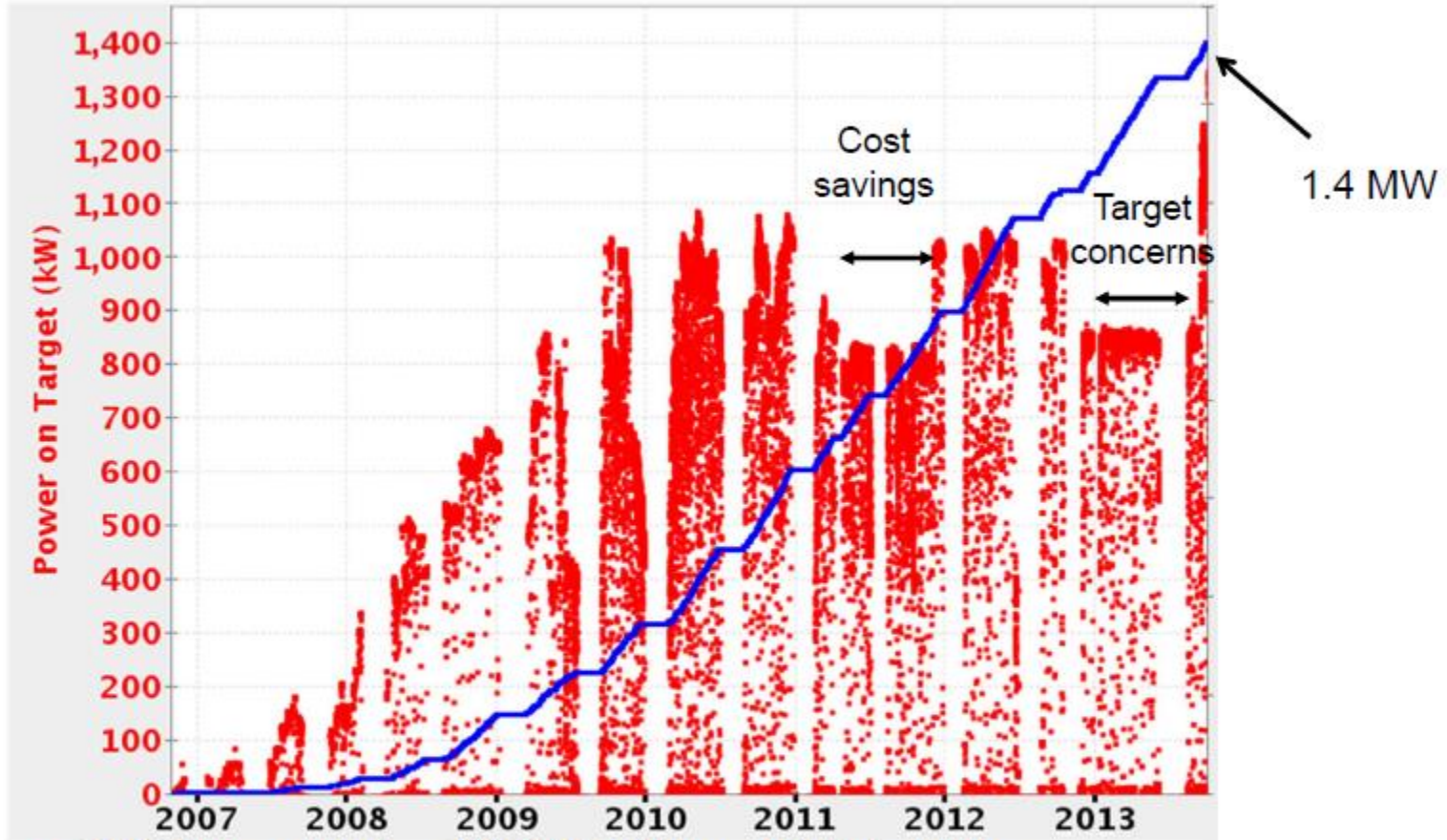

- SNS has run at ~ 1 MW for the past 3-4 years
  - Not accelerator limited
  - Recently operated up to 1.4 MW

J. Galambos

43 Managed by U1-Danielle



# SNS : Design vs achieved parameters

## SNS Linac : Achieved accelerating gradients in SC cavities

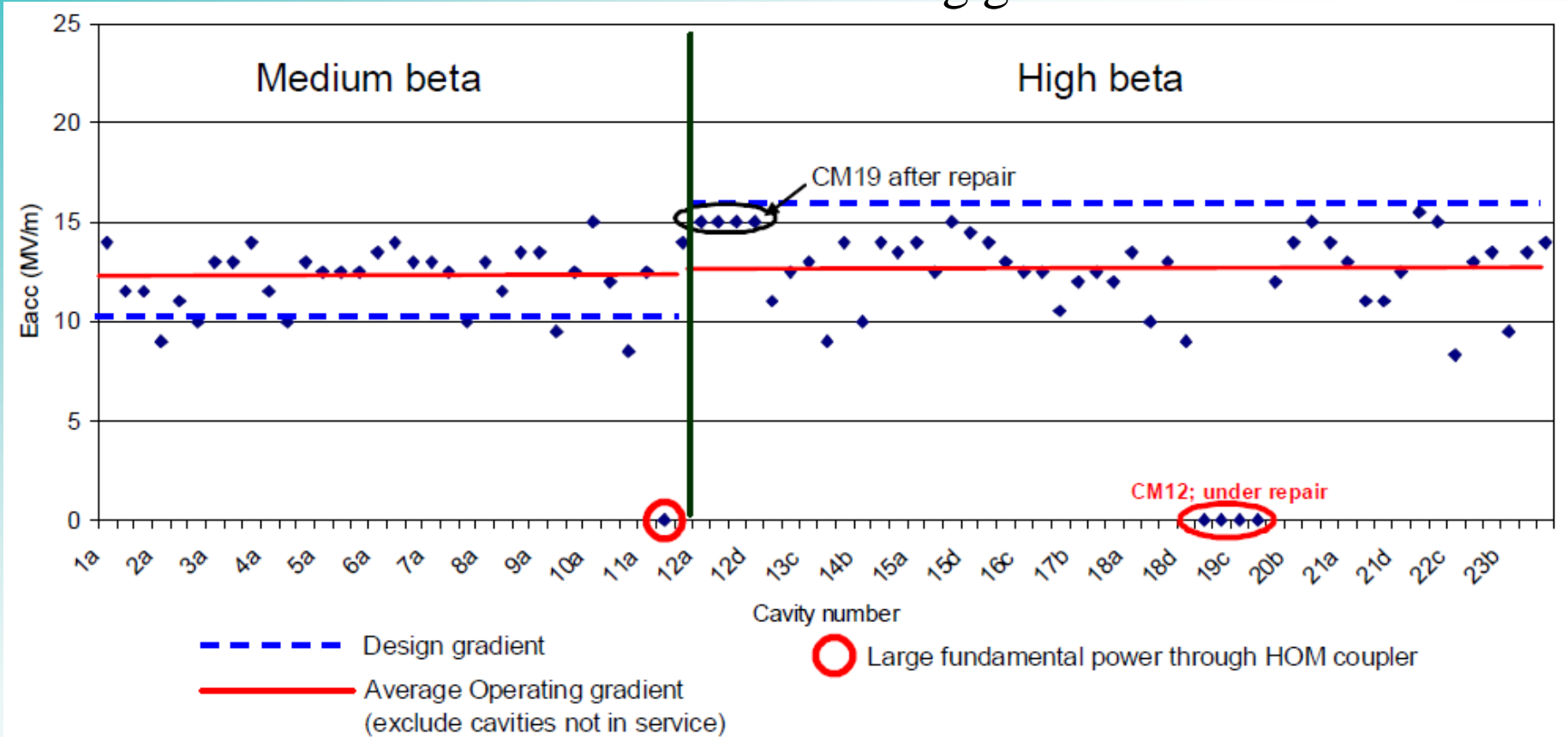

**Upgrades plans:** beam power upgrade to 3 MW with increasing beam energy from 1.0 GeV to 1.3 GeV (adding 9 additional high-beta cryomodules) and by increasing beam current from 38 mA to 59 mA.



## Beam Loss in the Superconducting Linac

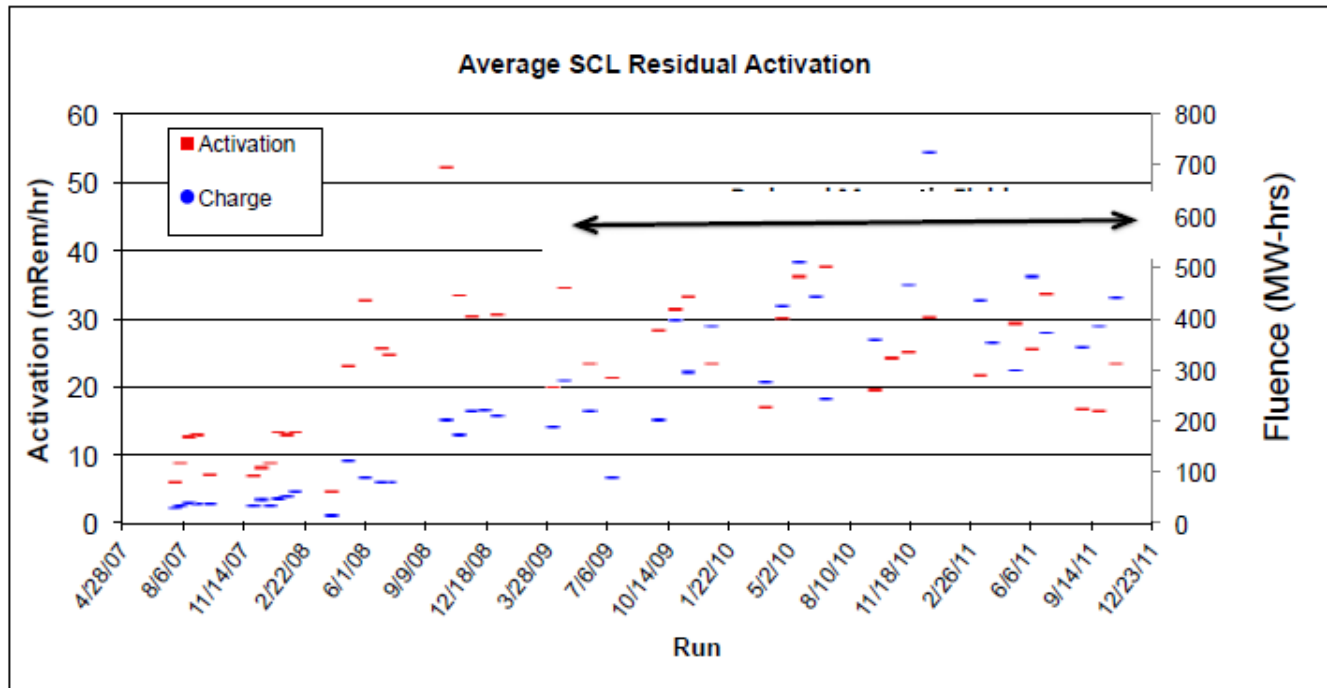

- High power proton beam operational loss limit: 1 W/m
  - 1 part per million at full energy!
- SNS observed a low level of beam loss / machine activation
  - Unexpected – not predicted in design stage!
  - OK for 1 MW – trouble for 10 MW

*J. Galambos*





ESS : European Spallation Source  
(Lund, Sweden)

(Under construction)



# ESS : the European Spallation Source

## Evolution of the performance of neutron sources

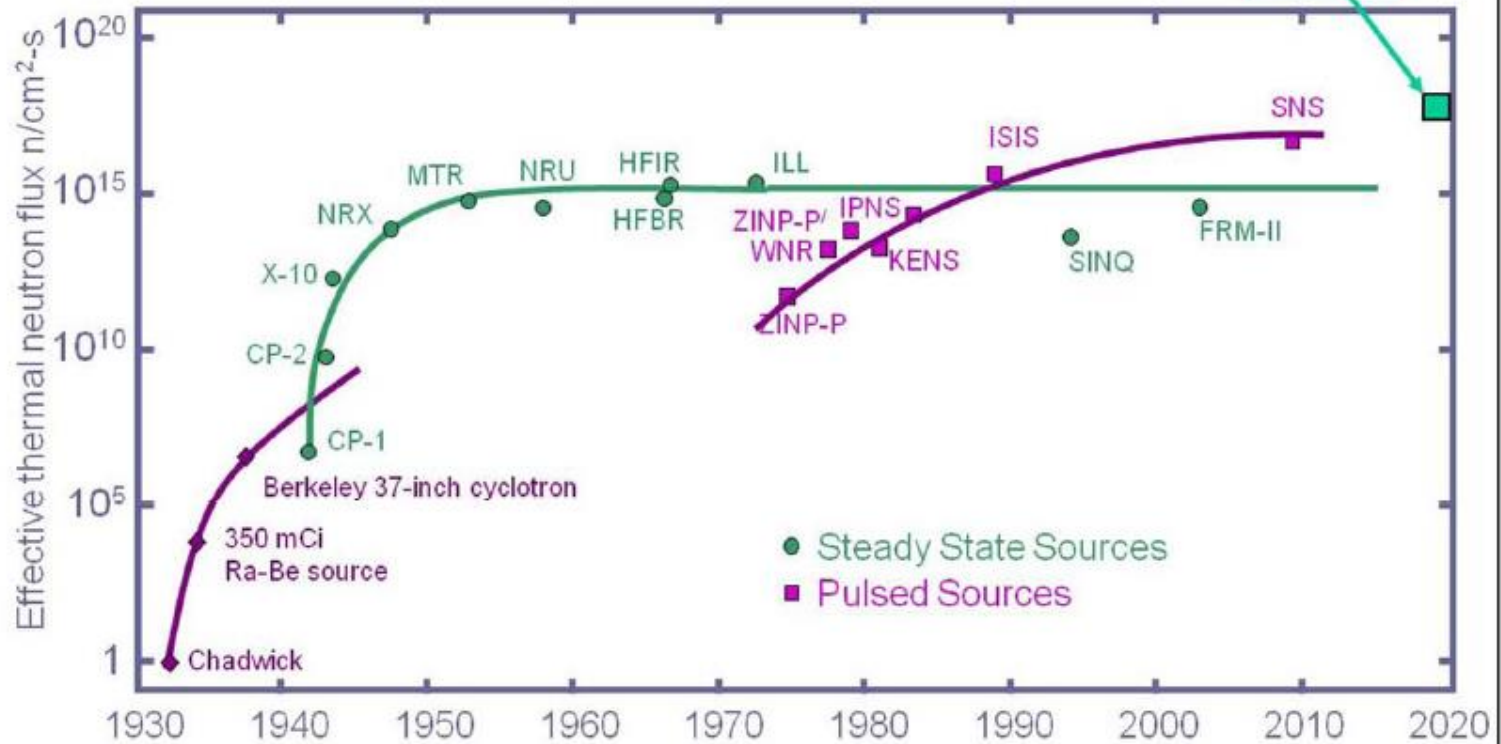

(Updated from *Neutron Scattering*, K. Skold and D. L. Price, eds., Academic Press, 1986)



# ESS : the European Spallation Source

OECD: « a high power spallation source in each global region »





# ESS : the European Spallation Source



# 17 nations committed to build ESS



Cash contributions  
from Sweden, Denmark  
and Norway

In-kind contributions  
from the other  
14 nations



50% of construction and  
15-20% of operations  
costs



**Construction cost: 1843 M€**

**Operation cost: 140 M€**

**Decommissioning cost: 177 M€**



**ESS AB in 2014, 250 people, 32  
nationalities**





# ESS : the European Spallation Source

**ESS Linac: High Power Proton Accelerator: 5 MW of beam power**

- Protons (H<sup>+</sup>), 2,0 GeV
- Pulse 2.86 ms, 62 mA
- Rep. rate.: 14 Hz
- > duty cycle 4 % (125 MW peak)
- Low loss
- High reliability > 95%
- Modular design to allow future upgrade



Sébastien Bousson, High Power Proton Linac, JUAS, Archamps, 13th March 2020



# ESS : the European Spallation Source

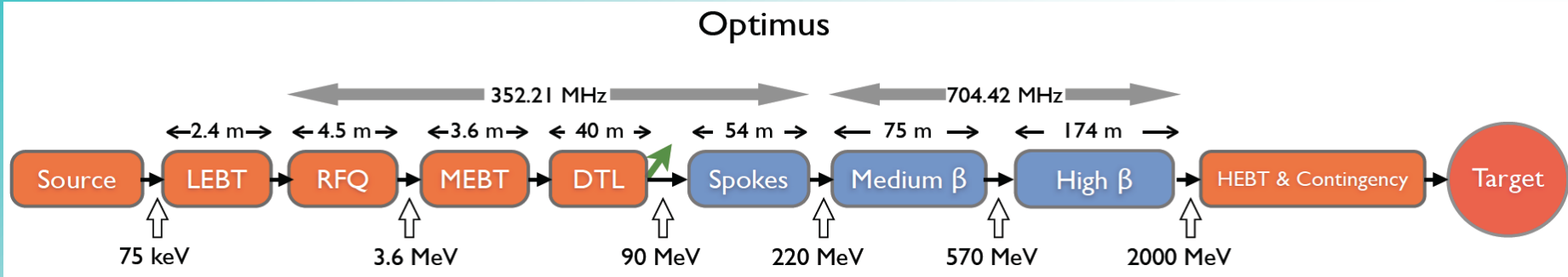

Section	Cavity $\beta$	Total number of Modules	Cavity frequency	# Cavity per module	# Cavity per section	Cryomodule length	Section length
Spoke	0.50	13	352 MHz	2	26	~ 2.9 m	54 m
Medium-beta	0.67	9	704 MHz	4	36	~ 6.7 m	75 m
High-beta	0.92	21	704 MHz	4	84	~ 6.7 m	174 m
Total		43			146		~ 300 m

- This architecture is mainly an evolution of the SNS linac with less critical subsystems: H- source, fast chopping, Pils RFQ, ring injection.
- Main innovation (risk?): Spoke Resonators are used to enhance the flexibility and the accelerating efficiency at medium energy.
- More robust than 2003 design: lower peak current for the same power (higher energy) without any extra length (power coupler limitation) and no funnelling.



# ESS : the European Spallation Source

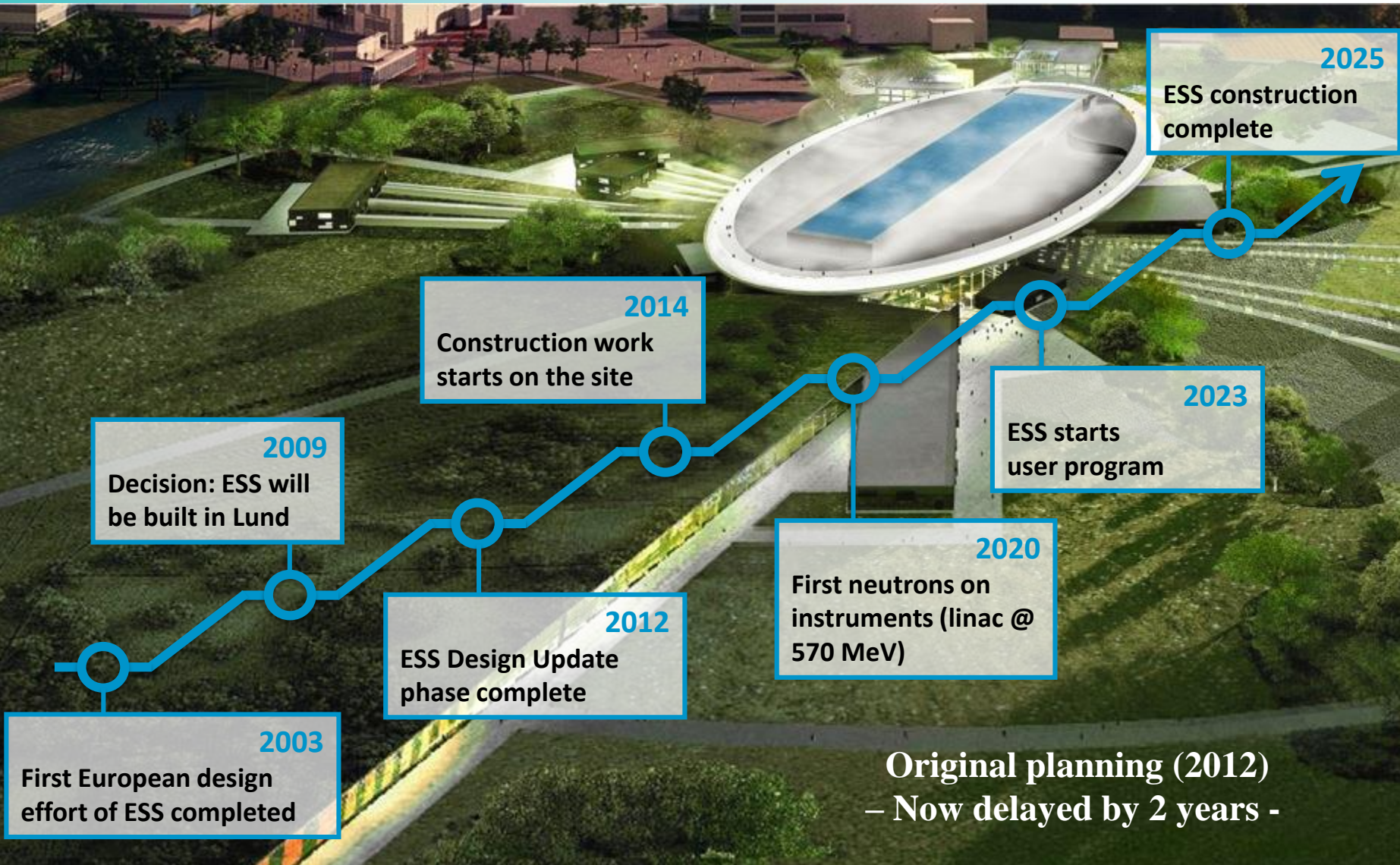





## ESS site Mars 2014





# ESS : the European Spallation Source

August 2017





# ESS : the European Spallation Source

March 2020





# ESS : the European Spallation Source

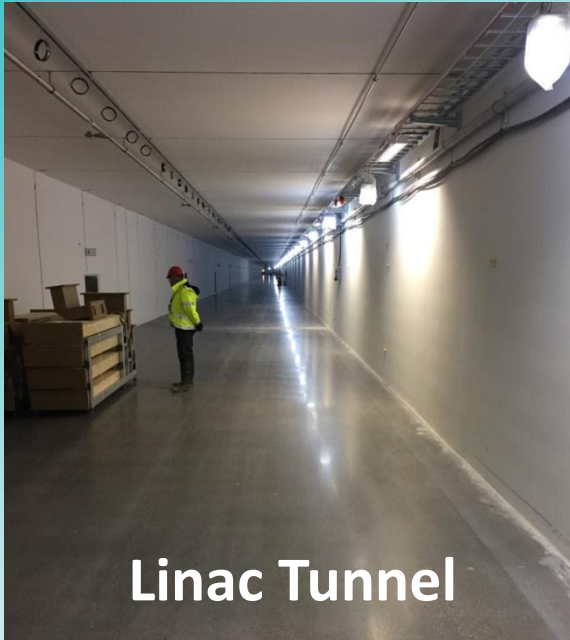

Linac Tunnel

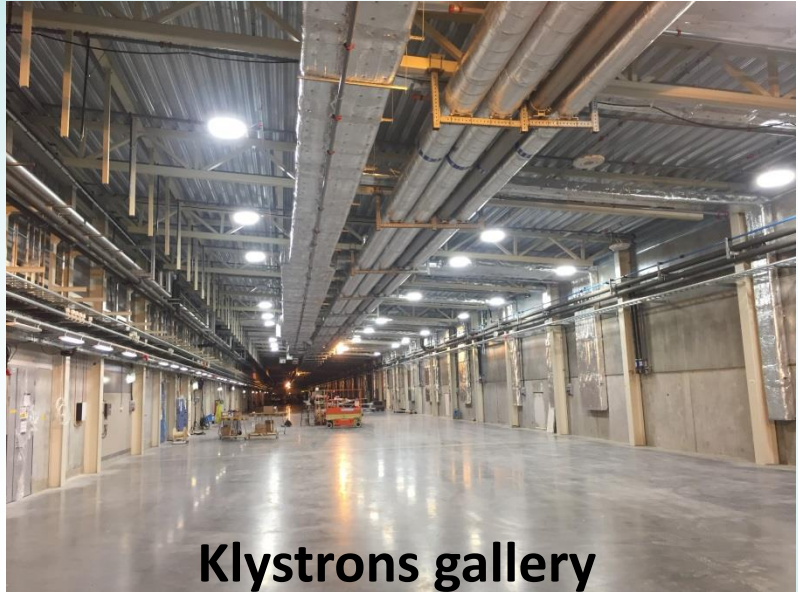

Klystrons gallery



A2T



Liquefier bldg



Compressor bldg



# ESS : the European Spallation Source

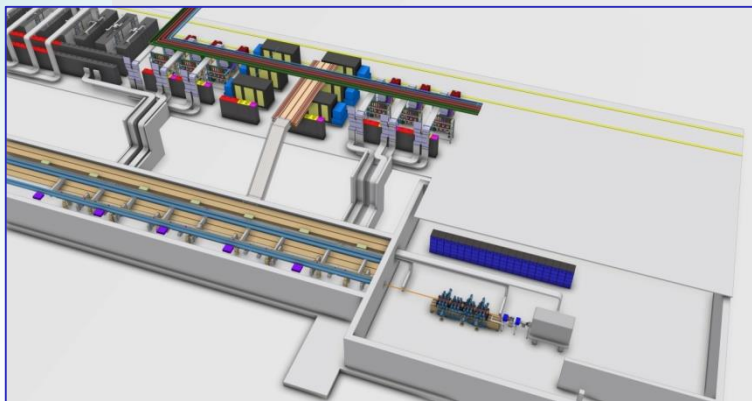
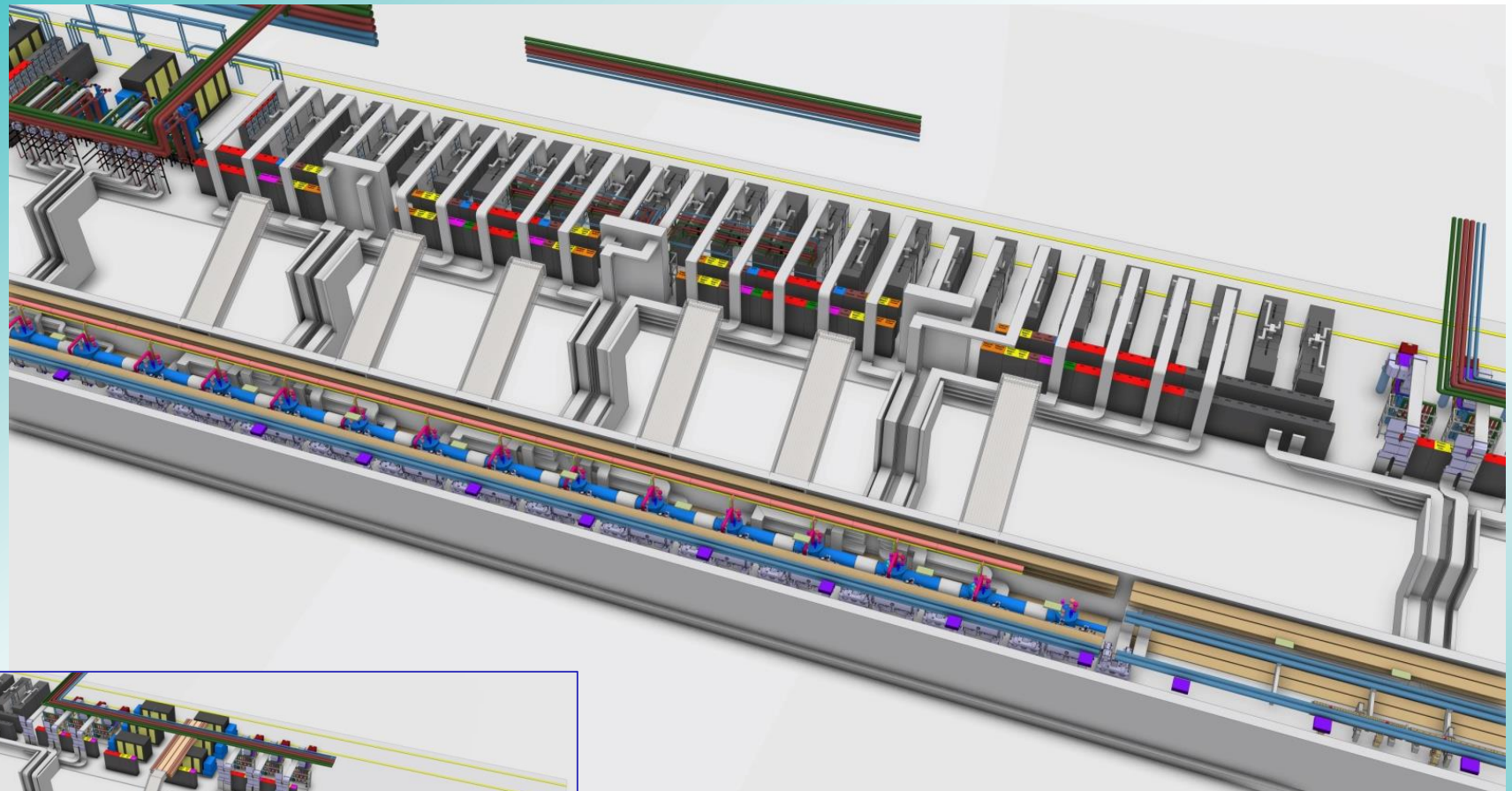



# ESS : the European Spallation Source

## Elliptical cryomodule

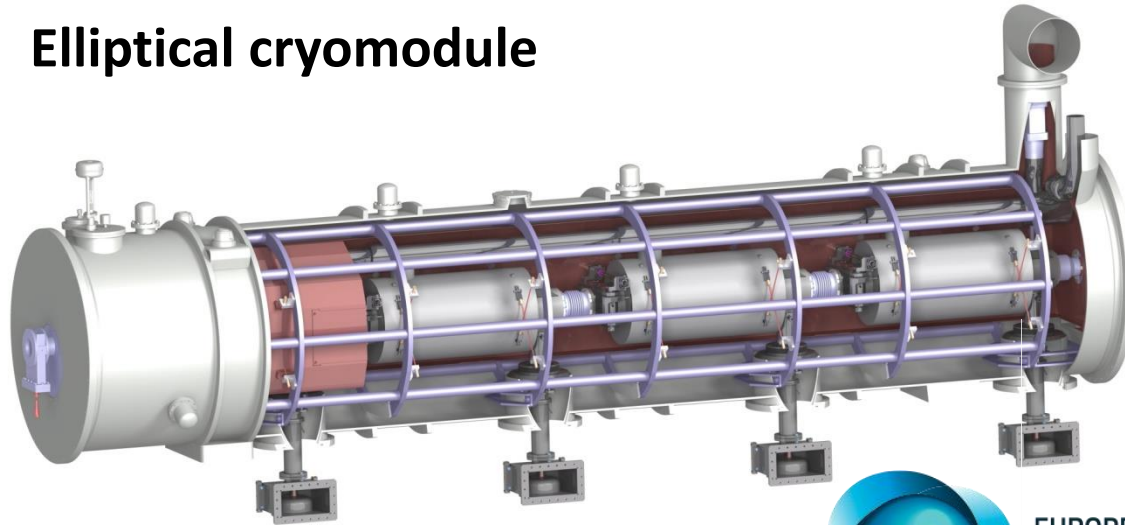

## Spoke cryomodule

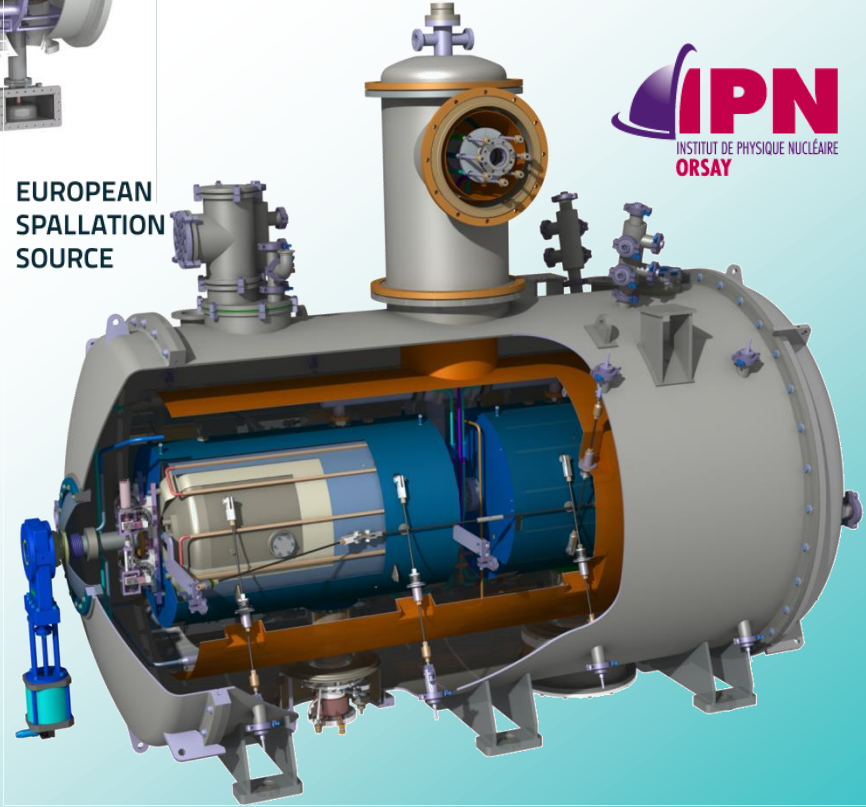

EUROPEAN SPALLATION SOURCE

All the linac sub-systems are currently in the prototyping phase





# ESS : the European Spallation Source

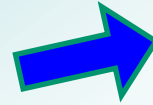

## Double Spoke SRF Cavities

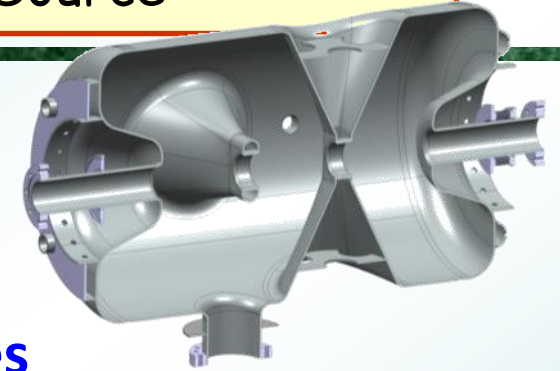

- Double spoke cavity (3-gaps), 352.2 MHz,  $\beta=0.50$
- **Goal: Eacc = 9 MV/m** [ $Bp= 62$  mT ;  $E_p = 39$  MV/m]
- 4.2 mm (nominal) Niobium thickness
- Titanium Helium tank and stiffeners
- Lorentz detuning coeff. :  $\sim -5.5$  Hz/(MV/m)<sup>2</sup>
- Tuning sensitivity  $\Delta f/\Delta z = 130$  kHz/mm



## Cold Tuning System

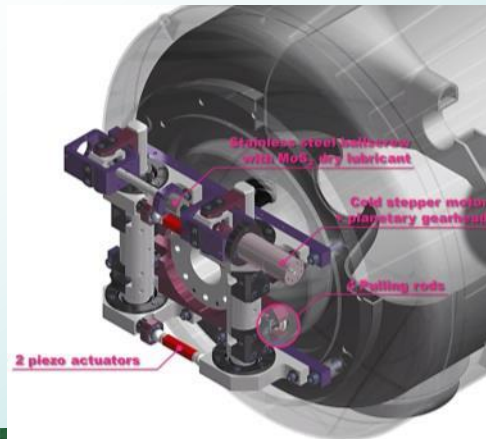

- Slow tuning (stepper motor):  
Max stroke:  $\sim 1.3$  mm  
Tuning range:  $\sim 170$  kHz  
Tuning resolution: 1.1 Hz
- Fast tuning (piezo-actuator):  
Applied voltage up to +/- 120V  
**Tuning range at 2K: 675 Hz (min)**



## Power Coupler

- Ceramic disk, 100 mm diameter
- **400 kW peak power (335 kW nominal)**
- Antenna & window water cooling
- Outer conductor cooled with SHE
- Doorknob transition from coaxial to  $\frac{1}{2}$  height WR2300 waveguide

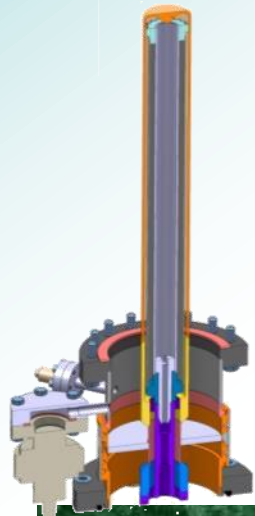



# ESS : the European Spallation Source



## Double-Spoke Vertical tests @ 2K

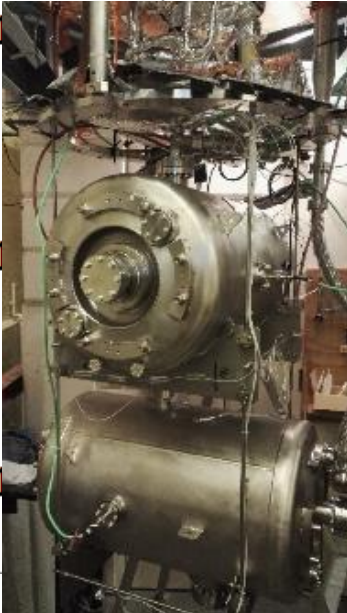
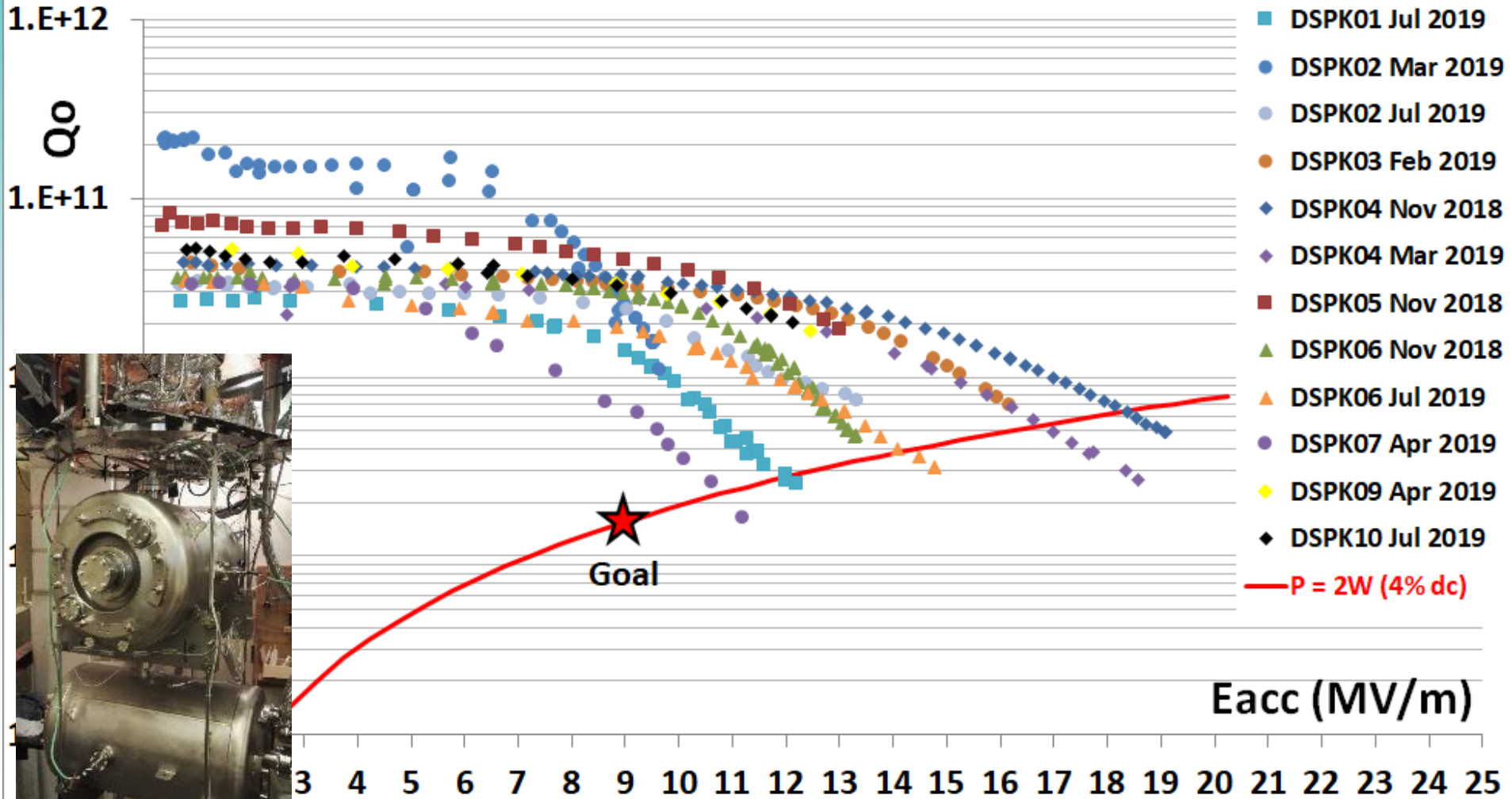

ousson, High Power Proton Linac, JUAS, Archamps, 13th March 2020





# High Power Proton Accelerator for Radiative Ion Beam Production

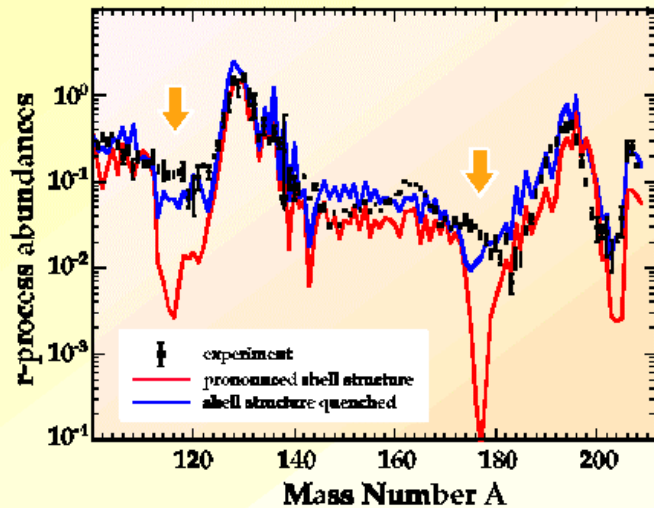

- nuclear astrophysics studies the **nuclear reactions** which happen in **stars**
- the reactions give rise to the energy production and make the chemical elements, "isotopic abundance", our world is made of
- the left figure shows, e.g. the abundance produced in the r-process, believed to happen when **supernovae explode** (black = measured abundance)

- the rapid proton (rp) and neutron (r) capture generate **very short-lived nuclei**
- the nuclear structure properties of these nuclei are often **unknown**.
- yet their masses, decay-properties, reaction cross sections critically **determine** the isotopic abundance (in the figure, note the difference between **normal** and **quenched** shell structure)
- this is a very important physics goal for accelerators, like **GANIL-SPIRAL, GSI...** or the future projects **RIA** or **EURISOL**
- the high-intensity EURISOL accelerator has remarkably similar specifications as the one of the **XADS!**

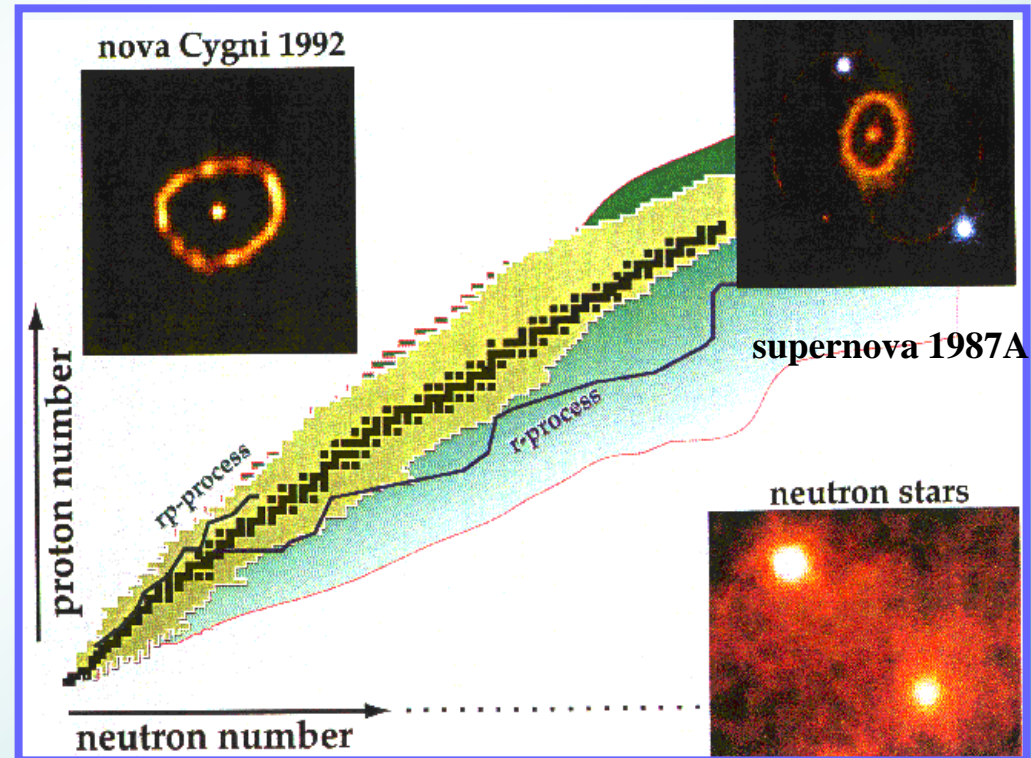



$$I = \sigma \times \Phi \times N \times \varepsilon_1 \times \varepsilon_2 \times \varepsilon_3 \times \varepsilon_4 \times \varepsilon_5$$

$\sigma$  : cross-section,  $\Phi$  : primary-beam intensity,

$N$ : target thickness,

$\varepsilon_1$ : product release and transfer efficiency

$\varepsilon_2$ : ion-source efficiency,

$\varepsilon_3$ : efficiency due to radioactive decay losses

$\varepsilon_4$ : the efficiency of the spectrometer

$\varepsilon_5$ : the post-acceleration efficiency

$$\Phi \times N = \text{Luminosity}$$

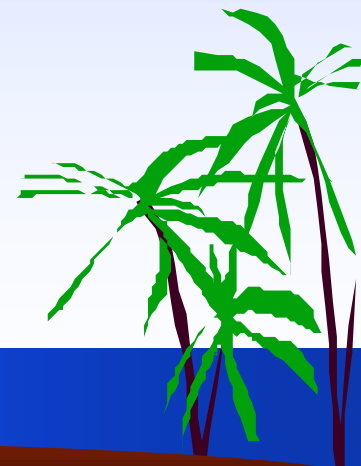
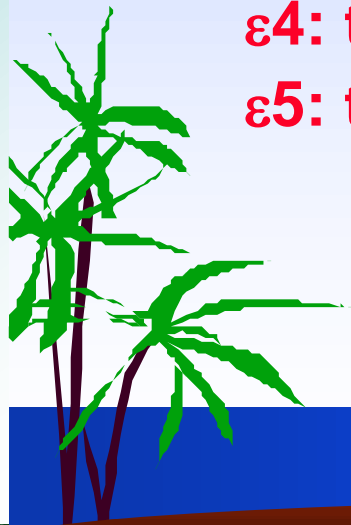



SPIRAL-2 : Radioactive ion beam production  
GANIL, Caen, France  
  
(under construction)



# Spiral - 2

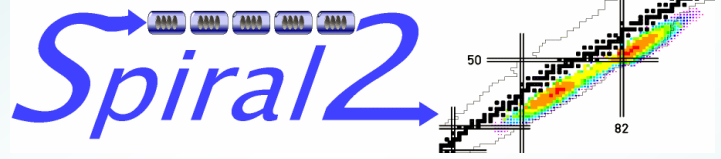
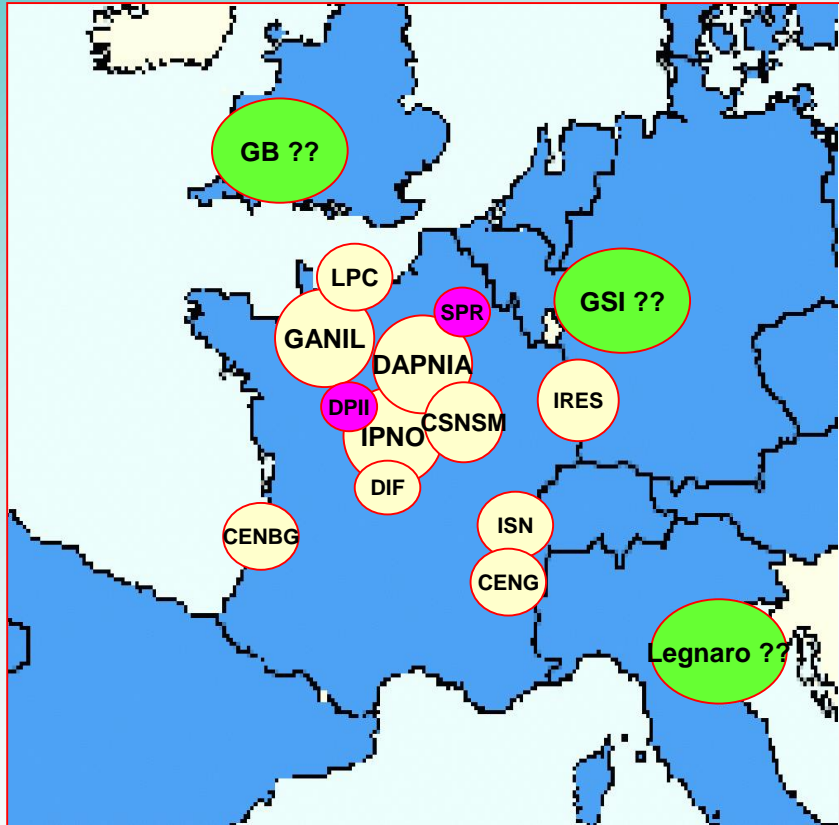

**SPIRAL II Project:**  
**13 French Laboratories**  
**International Collaborations**  
**135 M€ total cost (inc. manpower)**

**Project approved in May 2005**  
**Construction phase close to completion**

**First beam (injector) in 2014**

**First beam at the end of the linac expected for end 2016**

Existing GANIL

SP2 beam time : 44 weeks/y  
ISOL RIB beams : 28-33 weeks/y  
SP2 users : 400-500/y  
GANIL+SP2 Users : 700-800/y

CIME cyclotron  
 $E < 25$  A.MeV - RI Beam

DESIR Facility  
Low energy RIB

HRS and RFQ cooler

RIB production cave : up to  $10^{14}$  fiss./s

S3 : Super  
Separator  
Spectrometer

SC LINAC : 33MeV p, 40MeV d, 14.5MeV HI

Neutrons For  
Science

$A/q = 2$  source  
p, d,  $^3\text{He}$ , 5mA

$A/q = 6$  injector option

$A/q = 3$  HI source  
Up to 1mA

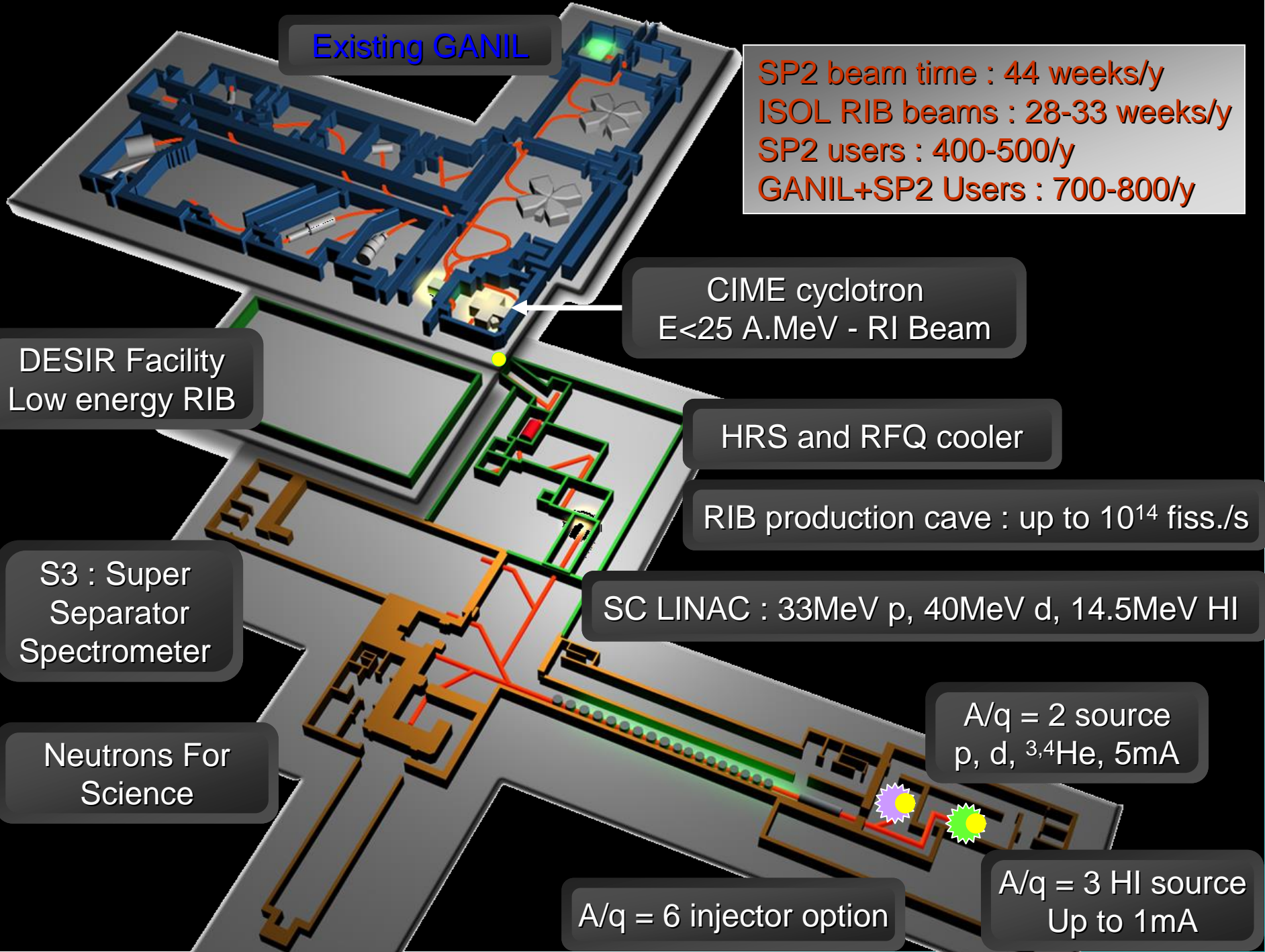



# Spiral - 2 : accessible elements



## Regions of the Chart of Nuclei Accessible with SPIRAL 2 Beams

- ⇒ light beams
- ⇒ heavy ions
- ⇒ RIB induced reactions

Production of radioactive beams/targets:  
(n,α), (p,n) etc.

N=Z Isol+In-flight

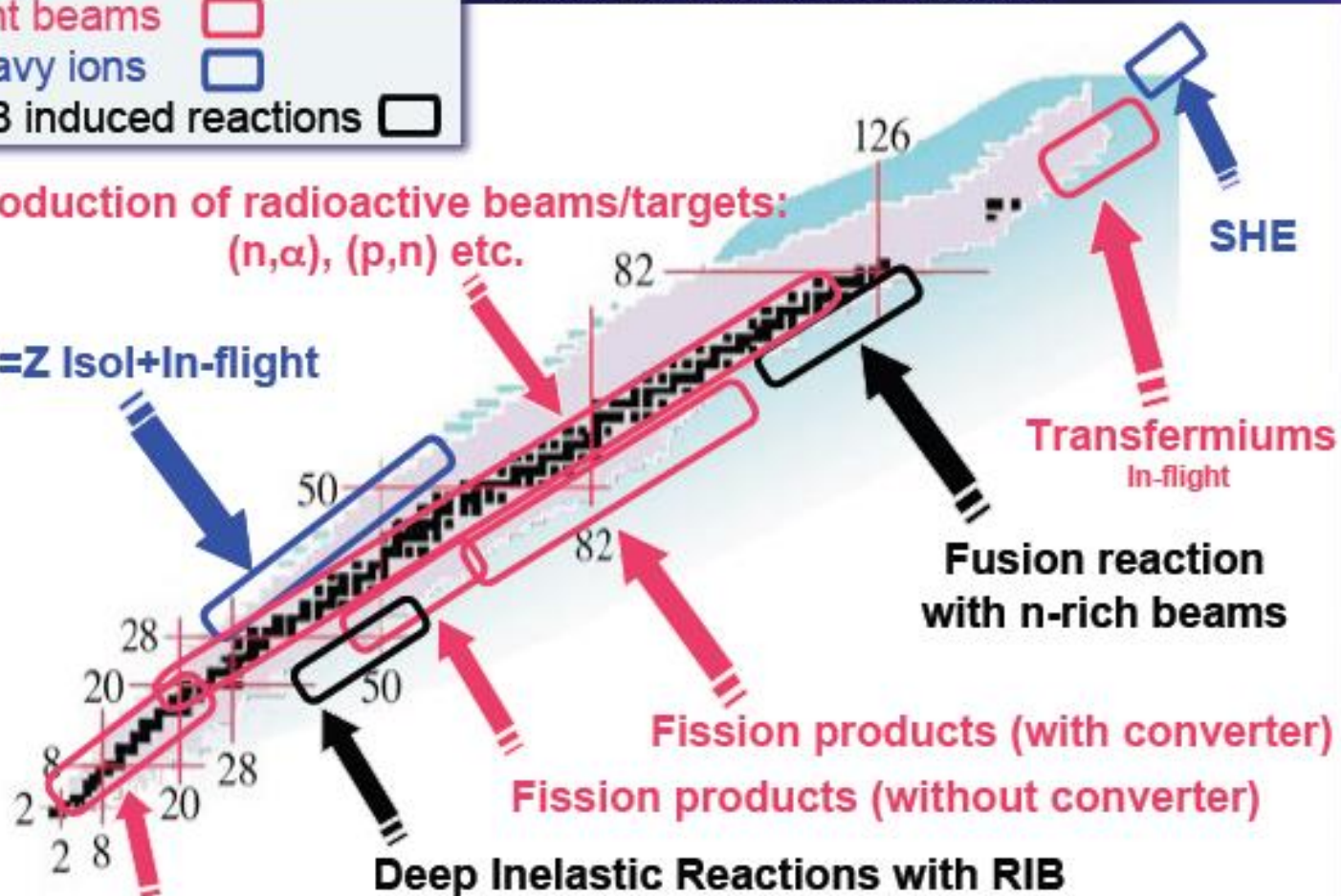

High Intensity Light RIB



# Spiral - 2 : the accelerator baseline configuration

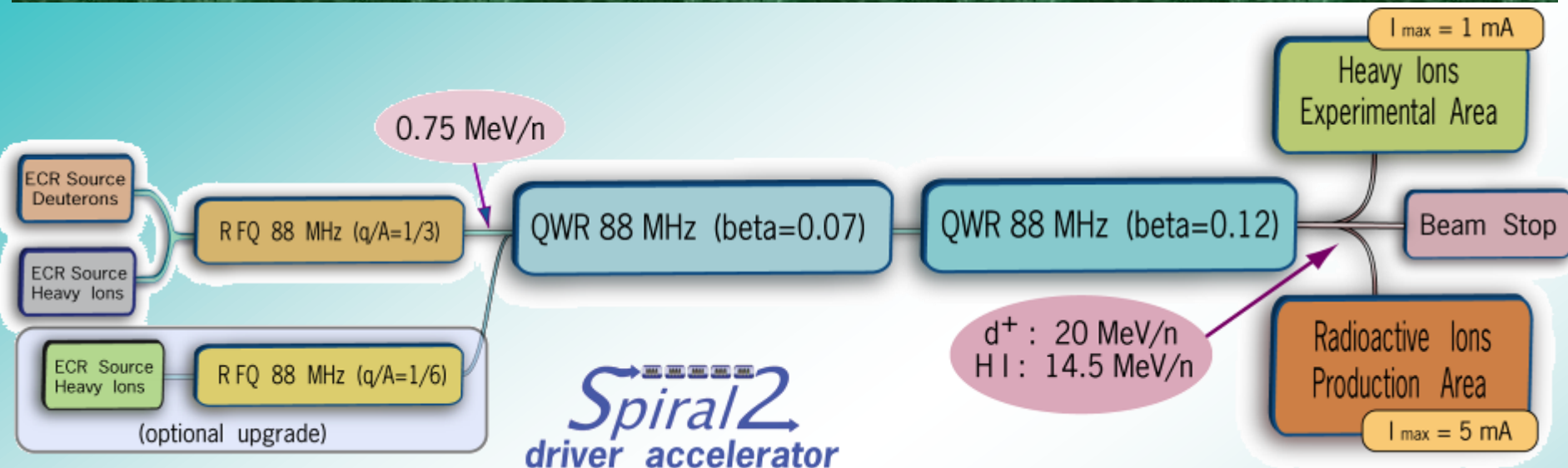

Particles	$p^+$	$D^+$	Ions	
Q/A	1	1/2	1/3	1/6
I (mA) max.	5	5	1	1
$W_0$ min. (Mev/A)	2	2	2	2
$W_0$ max. (Mev/A)	33	20	14.5	8.5
CW max. beam power (KW)	165	200	44	48

Total length: 65 m (without HE lines)

- $D^+$  : ECR ion source
- Heavy Ions : ECR Ion Source
- Slow and Fast Chopper
- RFQ (1/1, 1/2, 1/3) & 3 re-bunchers
- 12 QWR beta 0.07 (12 cryomodules)
- 14 (+2) QWR beta 0.12 (7+1 cryomodules)
- 1 kW Helium Liquifier (4.2 K)
- Room Temperature Q-poles
- Solid State RF amplifiers (10 & 20 KW)
- 6.5 MV/m max  $E_{acc} = V_{acd}/(\beta_{opt}\lambda)$  with  $V_{acc} = \int E_z(z) e^{i\omega z/c} dz$ .





# Spiral - 2 Linac : schematic view

## SPIRAL-2 Linac

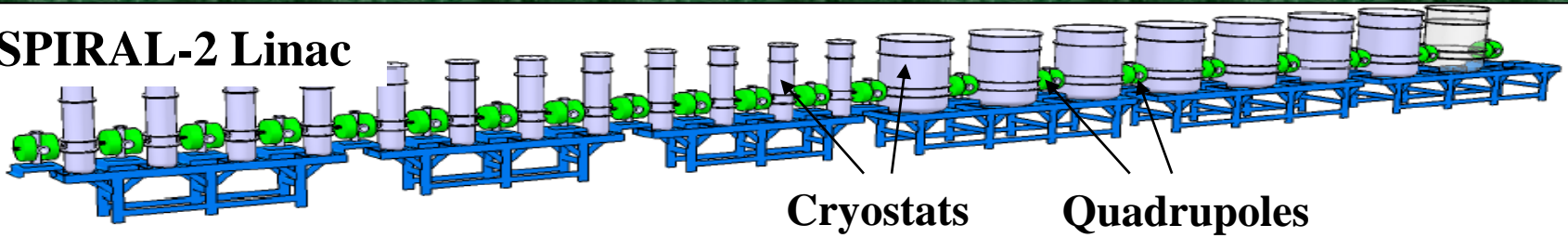

Cryostats

Quadrupoles

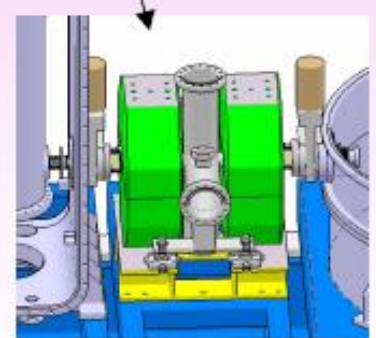
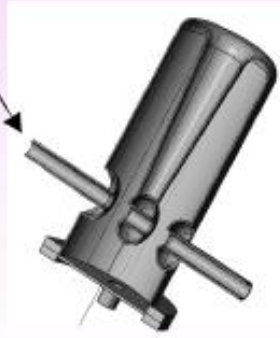
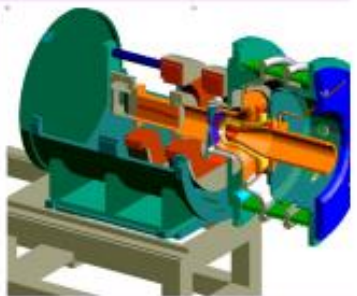
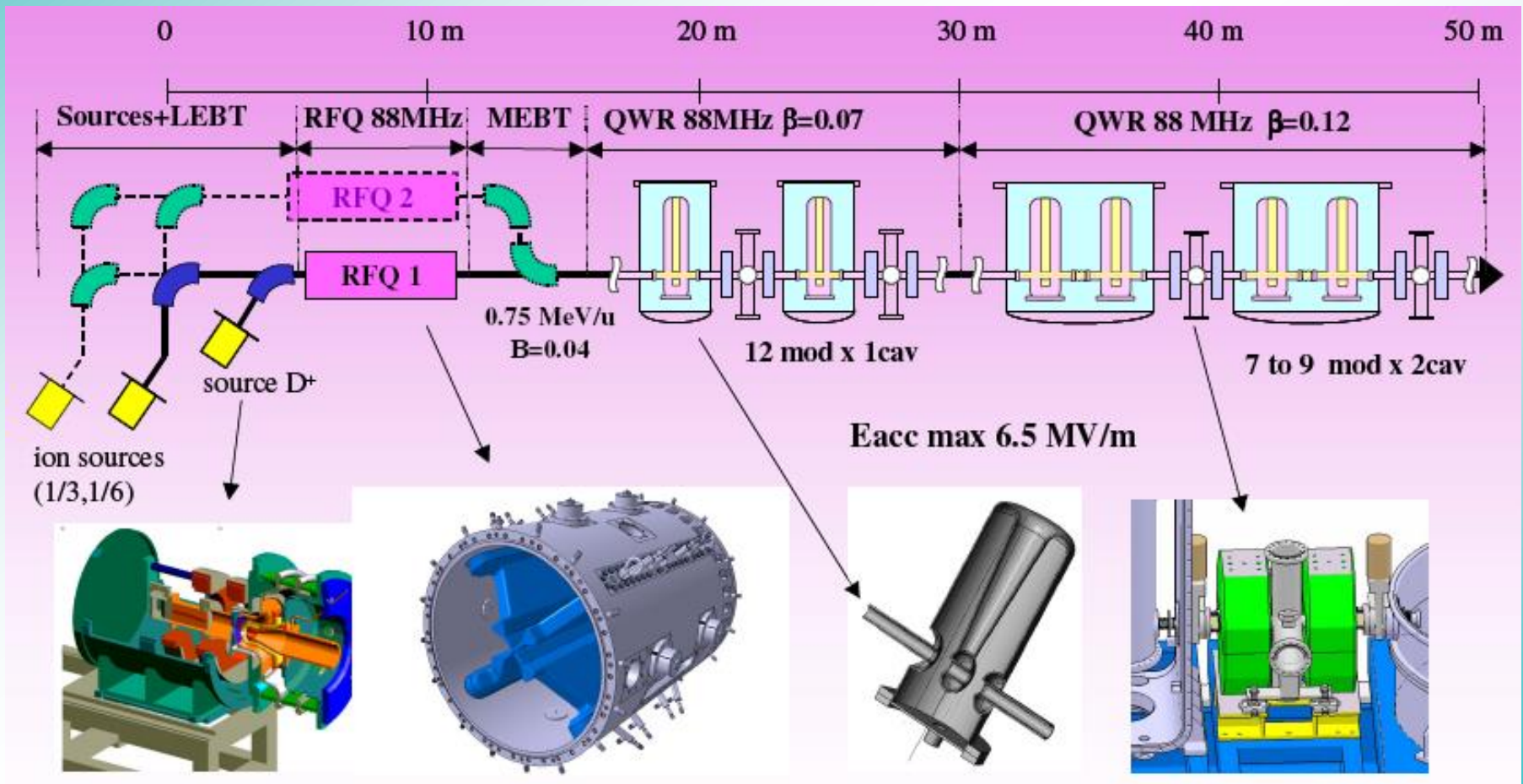



# Spiral - 2 Linac : High beta SC cavities

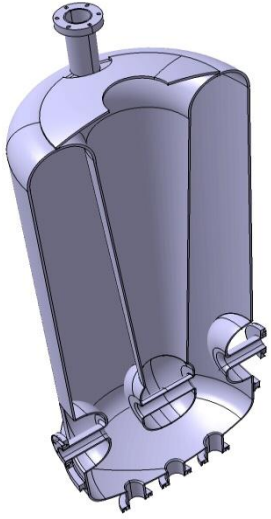

Frequency [MHz]	88.05
$\beta_{\text{optimal}}$	0.12
$E_{pk}/E_{\text{acc}}$	5.56
$B_{pk}/E_{\text{acc}}$ [mT/MV/m]	10.18
$r/Q$ [ $\Omega$ ]	518
$V_{\text{acc}}$ at 6.5 MV/m & $b_{\text{opt}}$ [MV]	2.65
$G$ [ $\Omega$ ]	38
Beam $\phi$ [mm]	38
Cavity ext. $\phi$ [mm]	380
$Q_{\text{ext}}$	$1.2 \cdot 10^6$

## QWR 88 MHz SC Cavities

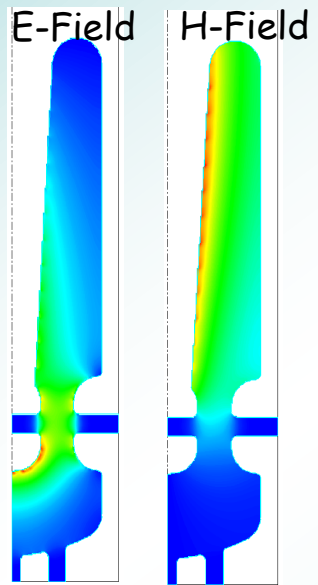



# Spiral - 2 Linac : High beta SC cryomodule

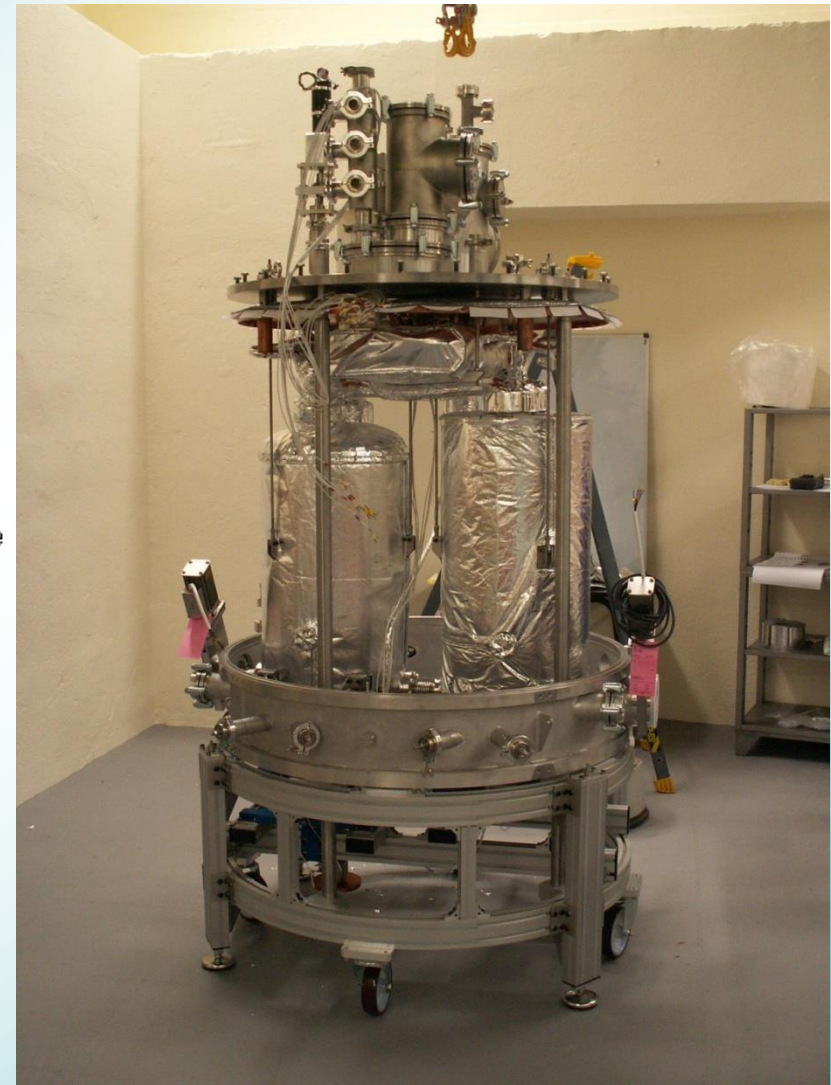
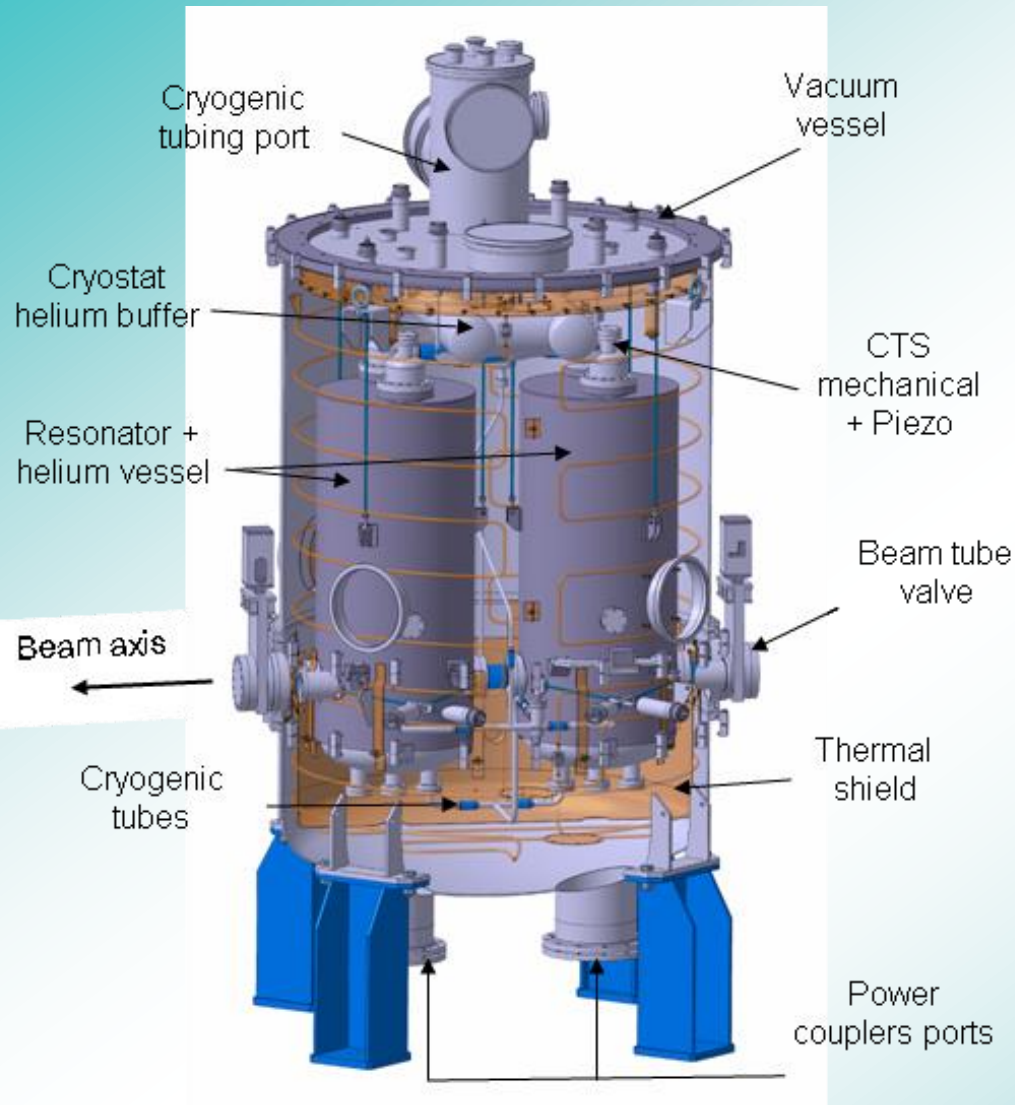



# SPIRAL-2 : high energy section cryomodule

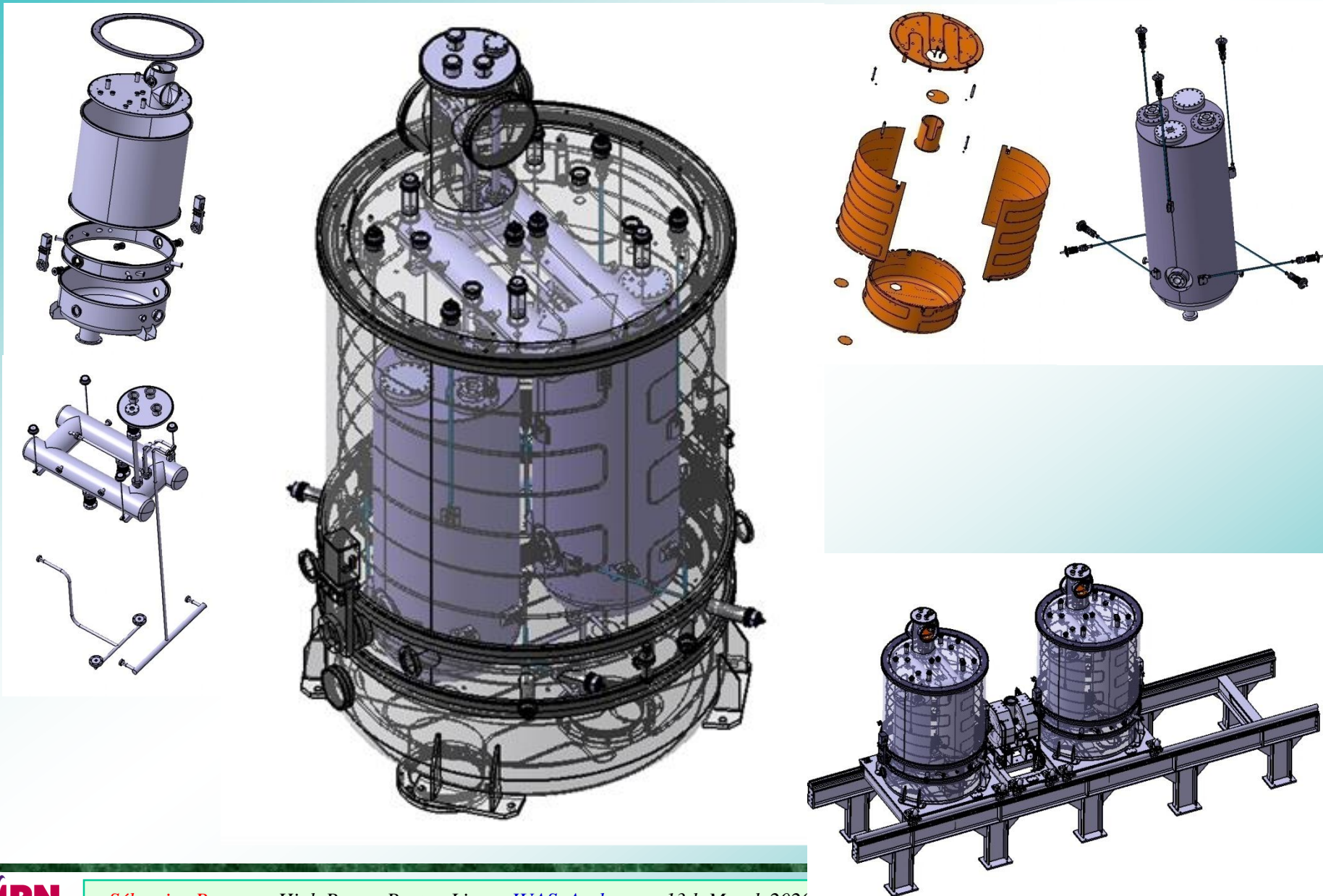



# SPIRAL-2 : High Beta Cavity RF Performances



QWR B, beta 0.12  
Vertical test results - T=4.2K

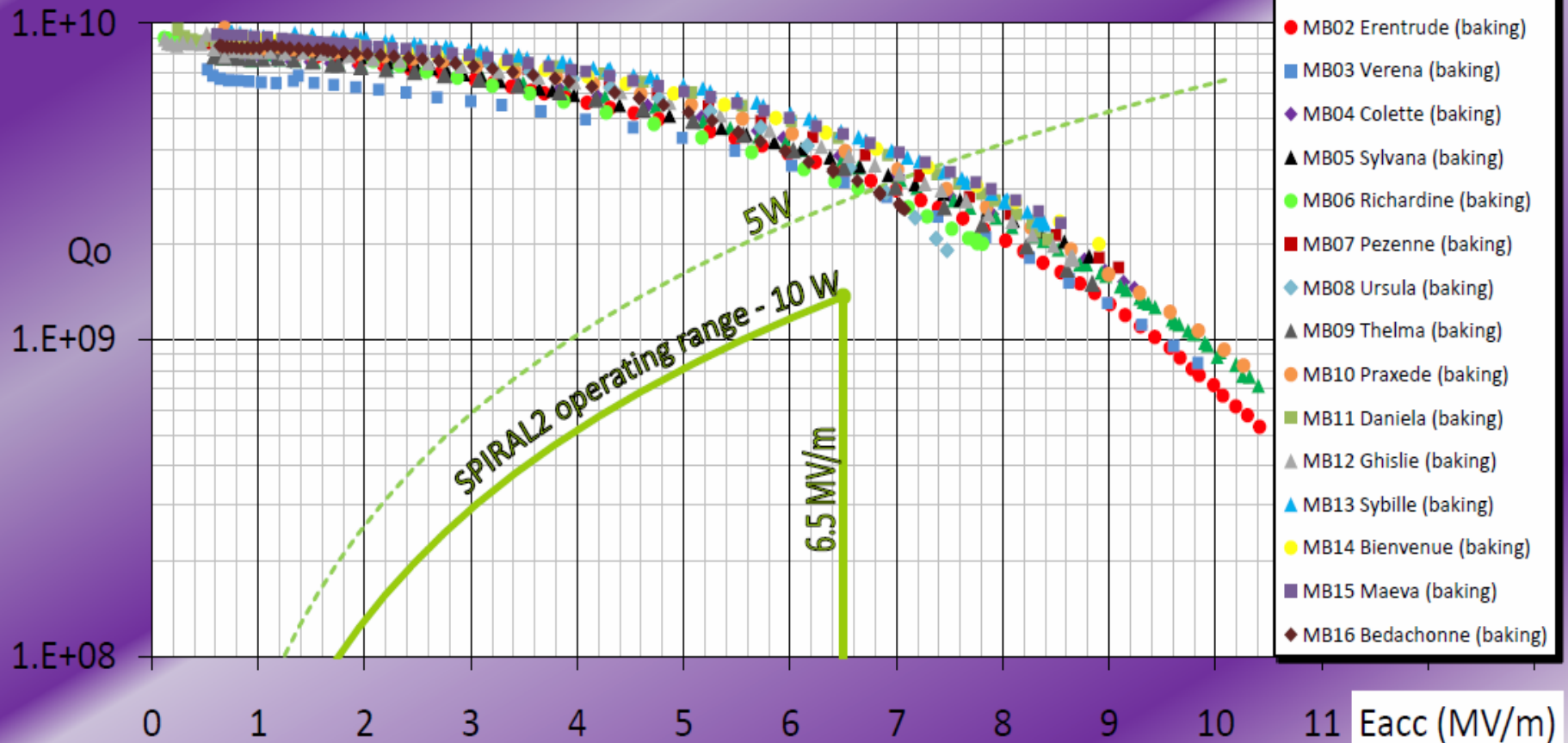



# SPIRAL-2 : High Beta Cavity RF Performances

Low  $\beta$

QWR A ( $\beta=0.07$ ) *Spiral2*

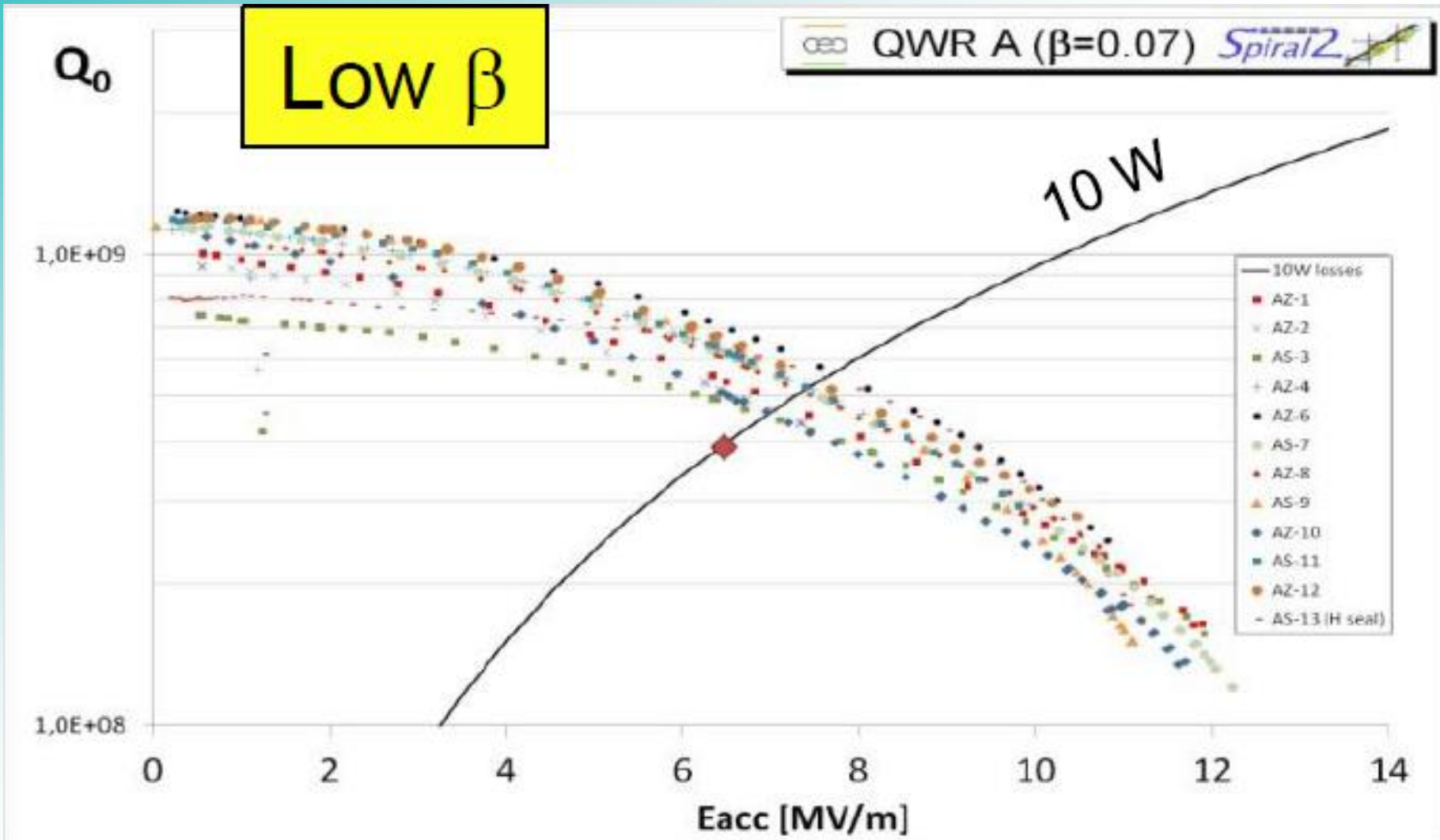



# SPIRAL-2 : Linac tunnel pictures





# SPIRAL-2 : Linac tunnel pictures



Spiral-2 commissioning has started in mid 2019. Power is being ramped up slowly. No major issues found up to now





EURISOL : Radioactive ion beam production  
(Project phase - site not yet chosen)

Under Design Study



EURISOL is the « next step after Spiral-2 » - Today, it's an European Research Program for a design study of a 5 MW radioactive ion beam production facility.

**1 GeV proton, 5 mA, 5 MW total power**  
Capabilities to accelerate also Deuterons and He3



# EURISOL PROJECT

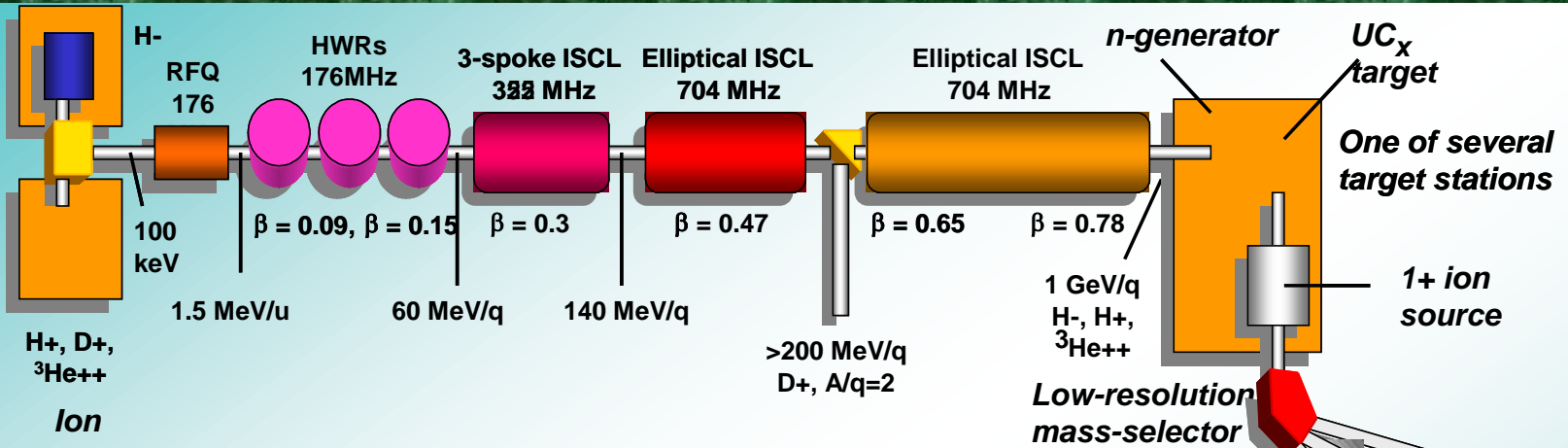

*A possible schematic layout for a EURISOL facility*

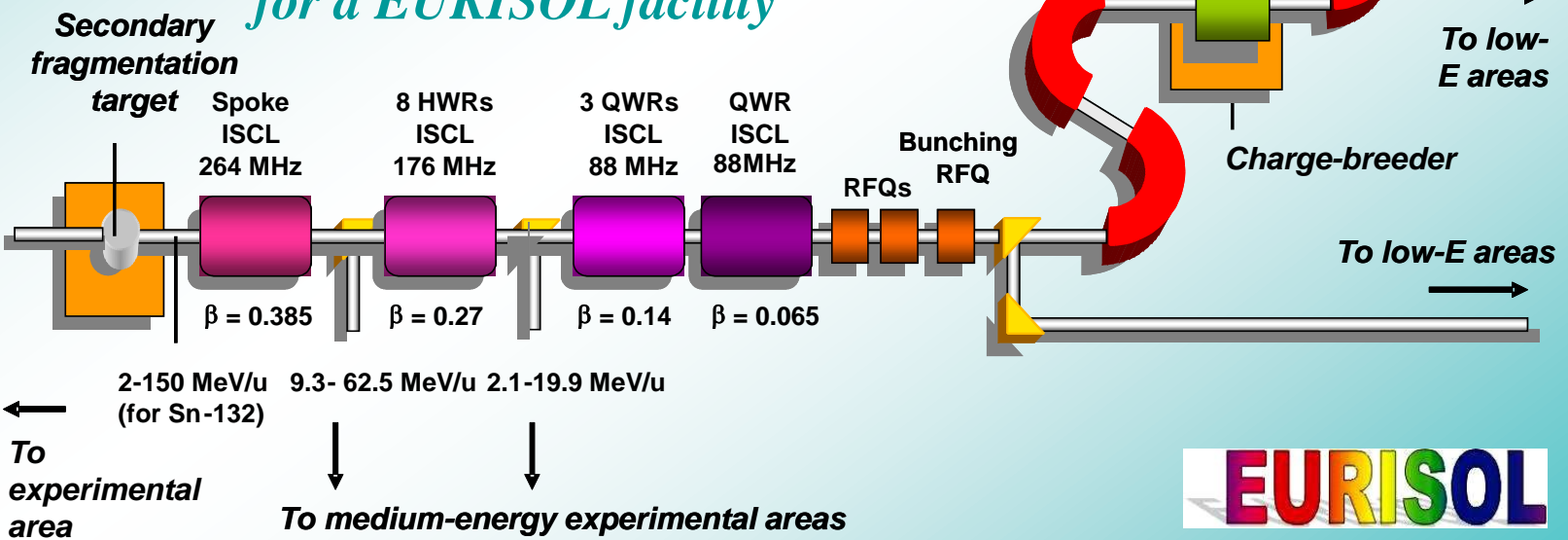



# Cost comparison

Option	beams in operation	length, m	extras required	cost M€	Δcost
#1 proton only	1 GeV p, 4 MW or 100 kW	203		199	+0 %
#2 $p + 100 \text{ MeV } d$	1 GeV p, 4 MW or 100 kW or 100 MeV d, 50 kW	203	176 MHz RFQ instead of 352	199	+0 %
#3a $p + 250 \text{ MeV } d$	1 GeV p, 4 MW or 100 kW or 200 MeV d, 125 kW	218	as #2 + low- $\beta$ to 140 MeV	211	+6 %
#3b $p + {}^3\text{He}$	1 GeV p, 4 MW or 100 kW or 2 GeV ${}^3\text{He}^{++}$ , 4 MW	223	as #2 + more $\beta=0.47$ cavities	220	+11 %
#4 $p + {}^3\text{He} + d$	1 GeV p, 4 MW or 100 kW or 200 MeV d, 100 kW or 2 GeV ${}^3\text{He}^{++}$ , 2 MW	231	as #3a + #3b	230	+16 %
#5 $p + {}^3\text{He} + d$ + multi-user p	1 GeV p, 1× 4 MW and 3×100 kW or 200 MeV d 125 kW or 2 GeV ${}^3\text{He}^{++}$ , 2 MW	231	H- injector+ 4 stripping stations	+3%	+19 %

# EURISOL : Low energy section : SARAF Scheme (Israel)

60 MeV, 5 mA p / d SC linac

Linac Length:  
~32 m

3<sup>rd</sup>– 9<sup>th</sup> cryostats  
7×8 SC HWR  
 $\beta_0=0.15$

1<sup>st</sup>, 2<sup>nd</sup> cryostat  
2×6 SC HWR,  
 $\beta_0=0.09$

176 MHz RFQ  
1.5 MeV/u  $A/q=2$   
3.8 m

**60÷140 MeV/q,  $1 \leq A/q \leq 2$**

- superconducting Triple-SPOKE cavities  $\beta=0.3$
- $E_{in} = 60 \text{ MeV/q}$
- $E_{out} = 140 \text{ MeV/q}$
- length  $\sim 30 \text{ m}$

IPNO cryostat design for SPOKE resonators

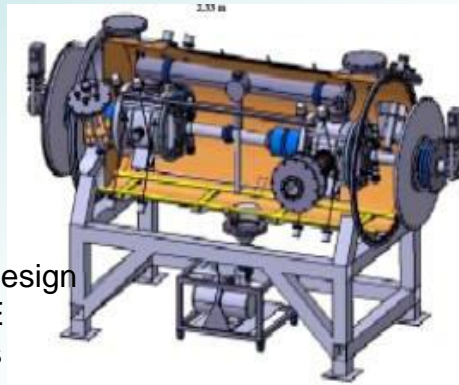

ANL 3-Spoke cavity

3-spoke cryomodule schematic

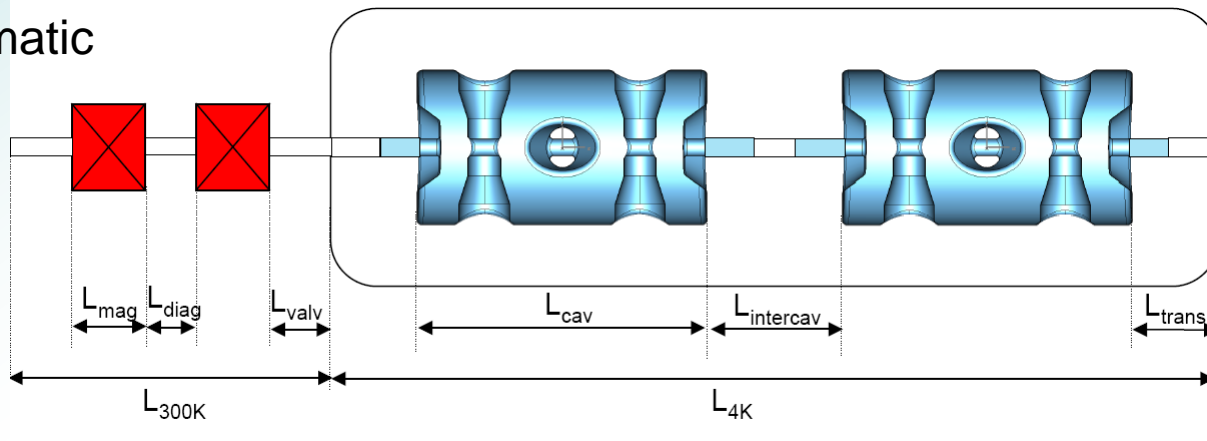



# EURISOL : High energy section : Elliptical cavities

140÷250 MeV/q,  $1 \leq A/q \leq 2$   
250÷1000 MeV/q,  $1 \leq A/q \leq 1.5$

- superconducting elliptical cavities
- $\beta=0.47, 0.65, 0.78$
- $E_{in}=140$  MeV/q
- $E_{out}=1000$  MeV/q
- section III+IV length  $\sim 160$  m

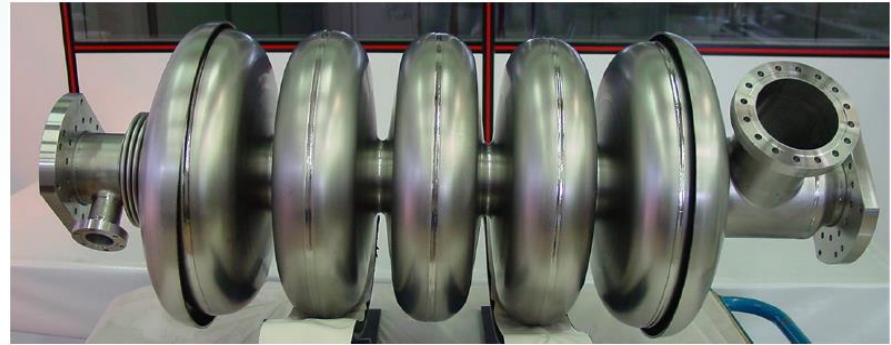

$\beta = 0.65, 704$  MHz elliptical cavity

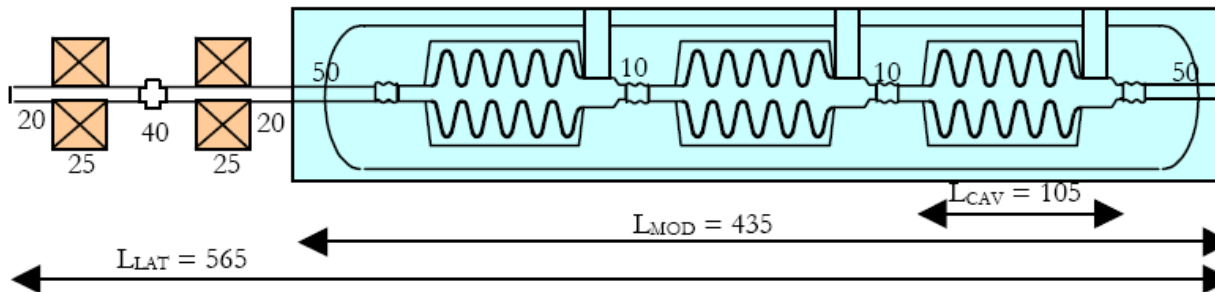

schematic of the  $\beta=0.47$  cryomodule



# High energy beam splitters

- magnetic stripping at 1 GeV of a small part of the  $H^-$  beam to  $H^0$
- bending of  $H^-$  with a magnetic dipole
- stripping of  $H^0$  to  $H^+$  by means of a stripper foil
- $H^-$  to target 1 and  $H^+$  to target 2(3,4).
- The spilled beam intensity can be controlled by adjusting the field strength of the magnetic stripper.

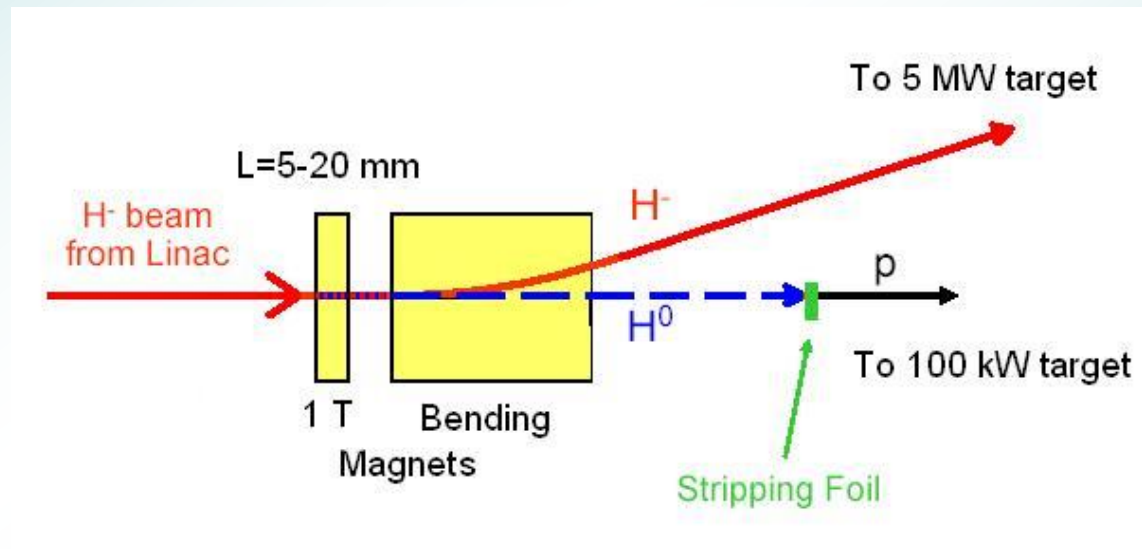





# Magnetic stripping probability

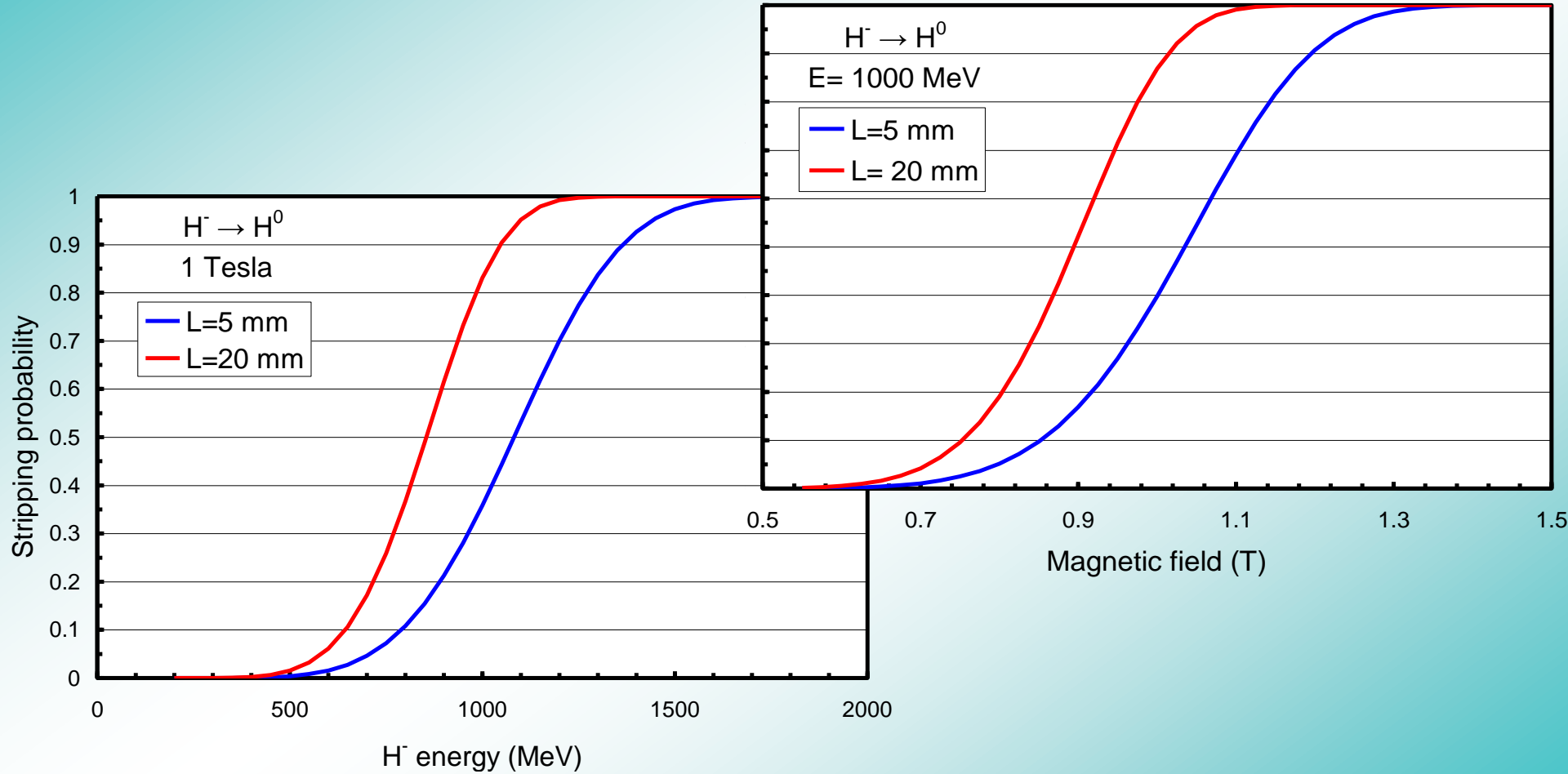



# 1 GeV Extraction possible scheme

- 3 splitting stations
- 4 simultaneous users of proton beams:
  - 1 × 4 MW line
  - 3 × 100 kW line
- 1 line specialized for 2 GeV,  $^3\text{He}^{++}$  (to be used alone)

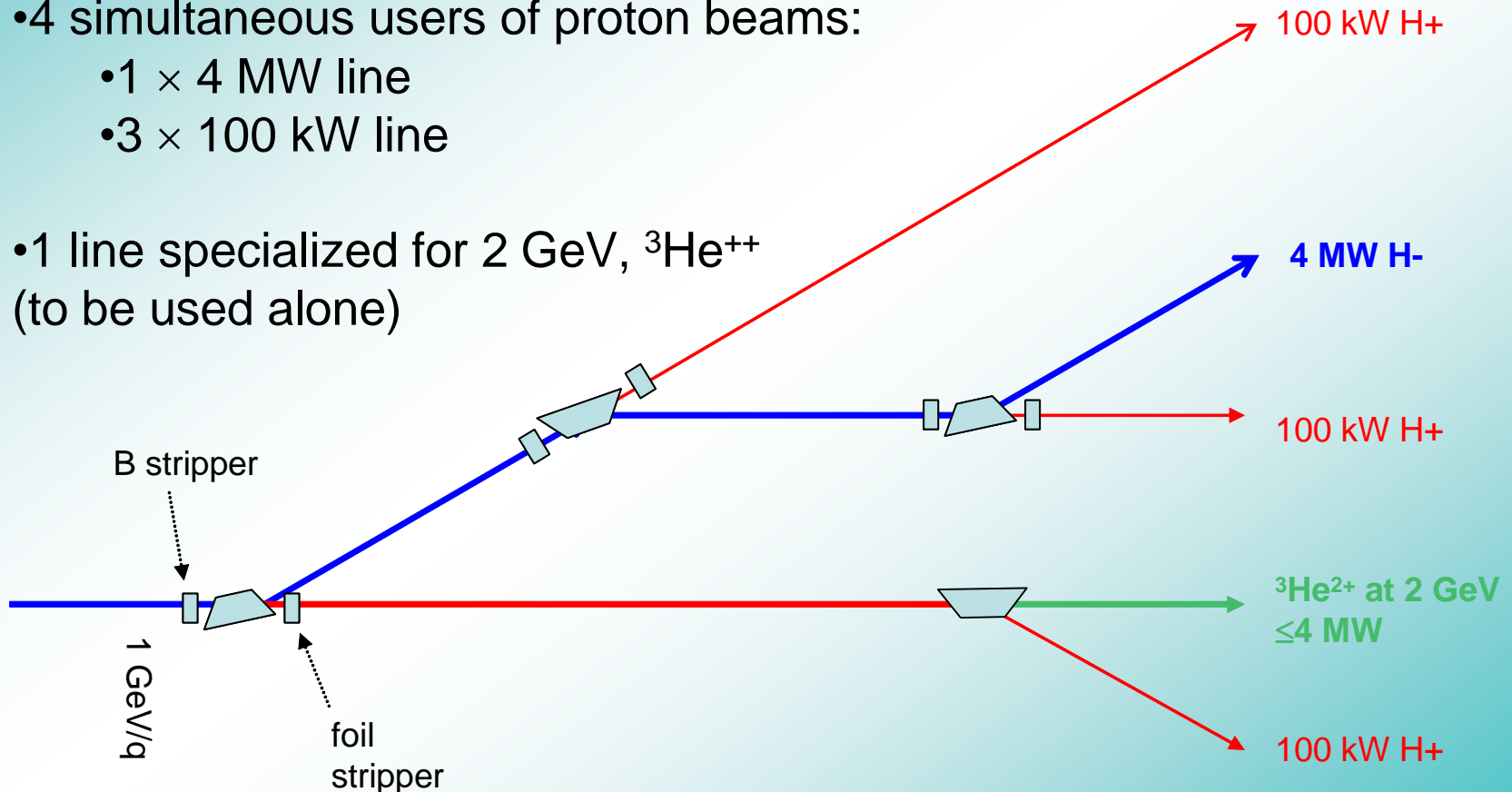



# High Power Proton Accelerator for Nuclear Waste Transmutation

# Transmutation of nuclear waste: Why & How

Probability of Fission/Neutron absorbed

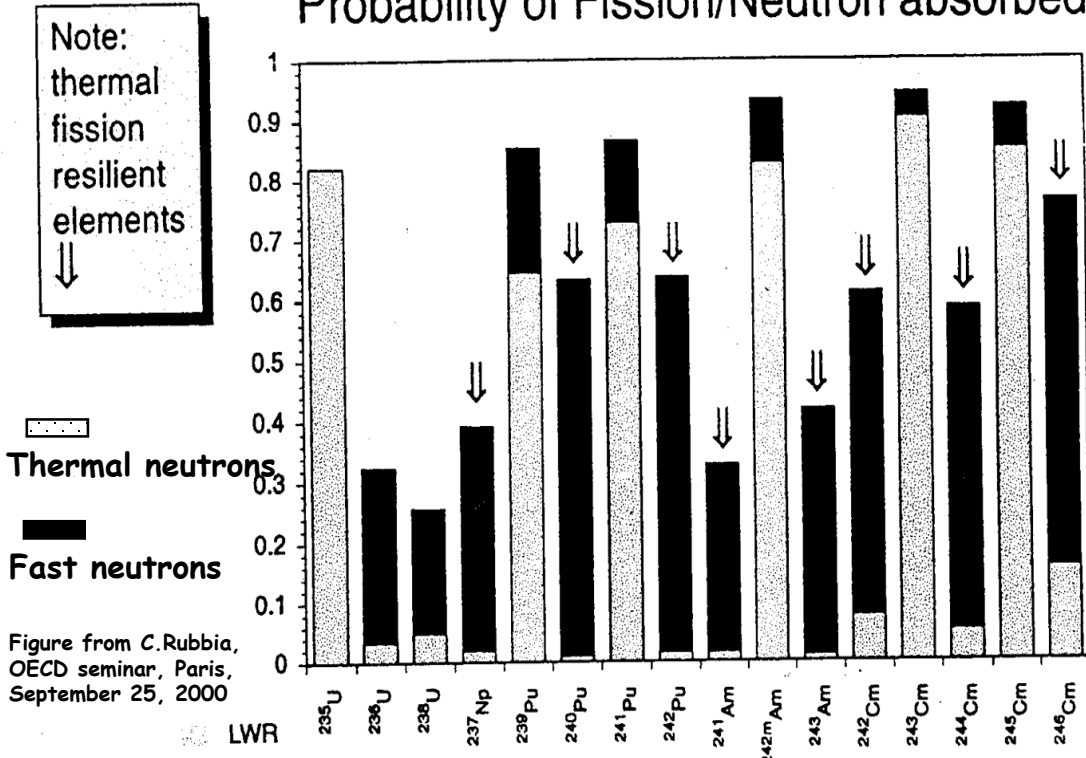

- 99.995% of the > 500 years lasting radiotoxic isotopes are concentrated in a few elements representing 1% of the spent fuel (300 kg/y/ 1GW<sub>el</sub> reactor)
- most of these are resilient to further burning in a LWR  
 → full transmutation needs fast neutrons
- fast breeder reactors like "SUPERPHENIX" ????

Alternative: use, for higher flexibility, safety and efficiency, (very) fast neutrons, produced by an accelerator, in combination with a subcritical reactor !

Note: Subcriticality is not virtue but necessity!

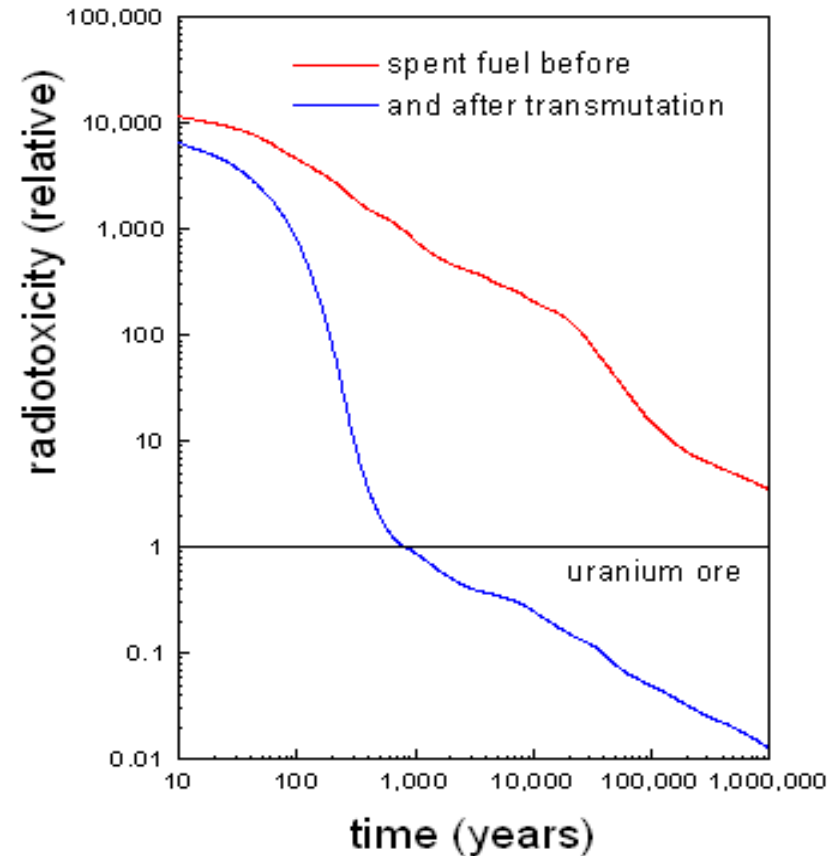
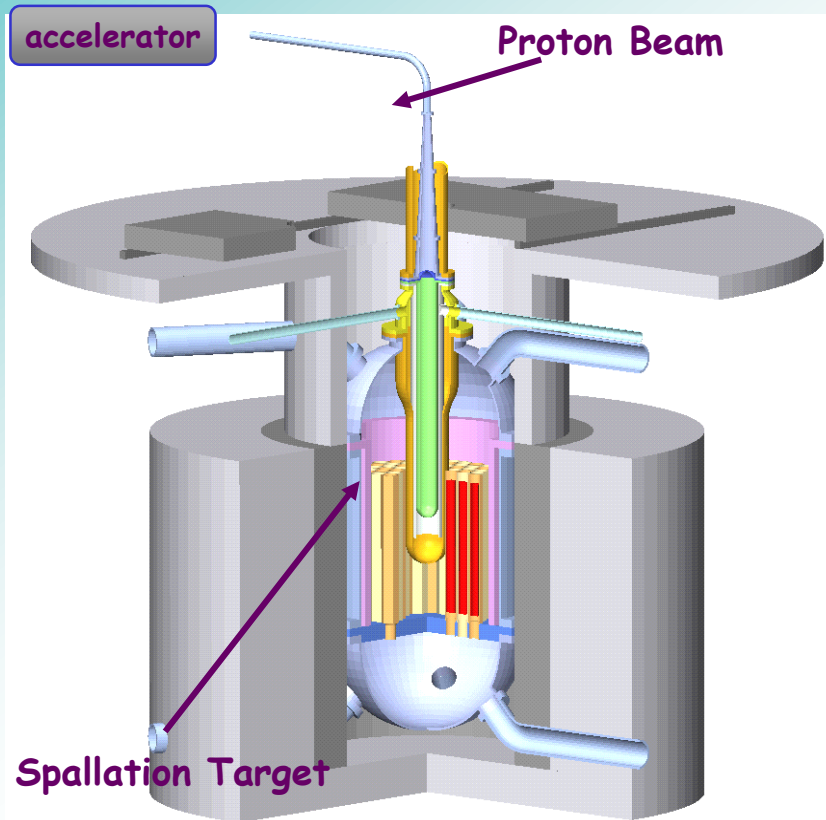



# European Transmutation Demonstration

## 1. XT-ADS (ADS prototype)

### Goals:

- **Demonstrate the concept** (coupling between accelerator, spallation target & reactor),
- **Demonstrate the transmutation**
- **Provide an irradiation facility** and an EFIT test bench

### Features:

- 50-100 MWth power
- Keff around 0.95
- 600 MeV, 2.5 mA proton beam (or 350 MeV, 5 mA)
- Conventional MOX fuel
- Lead-Bismuth Eutectic coolant

## 2. EFIT (Industrial Transmuter)

### Goals:

- Maximise the transmutation efficiency
- Easiness of operation and maintenance
- High level of availability for a cost-effective transmutation

### Features:

- Several 100 MWth power
- Keff around 0.97
- 800 MeV, 20 mA proton beam
- Minor Actinide fuel
- Lead coolant (gas as back-up solution)

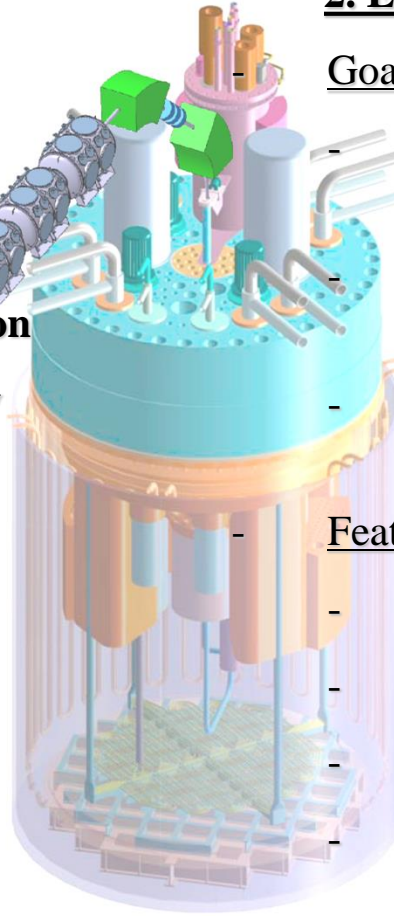



# Accelerator for an ADS : main specifications

## High-power proton CW beams

Table 1 – XT-ADS and EFIT proton beam general specifications

	XT-ADS	EFIT
Maximum beam intensity	2.5 – 4 mA	20 mA
Proton energy	600 MeV	800 MeV
Beam entry	Vertically from above	
Beam trip number	< 20 per year (exceeding 1 second)	< 3 per year (exceeding 1 second)
Beam stability	Energy: $\pm 1\%$ , Intensity: $\pm 2\%$ , Size: $\pm 10\%$	
Beam footprint on target	Circular $\varnothing$ 5 to 10 cm, “donut-shaped”	An area of up to 100 cm <sup>2</sup> must be “paintable” with any arbitrary selectable intensity profile
Beam time structure	CW, with 200 $\mu$ s zero-current holes every 10 <sup>-3</sup> to 1 Hz, + pulsed mode capability (repetition rate around 50 Hz)	

**Extrememely high reliability is required !!!**



# Most powerful proton accelerators

- **Linacs**
  - **LAMPF/LANSCE (~1970)**
    - 800 MeV
    - 1 mA H<sup>+</sup> average current
    - Peak H<sup>+</sup> current 16.5 mA @ 100 Hz and 625 μs pulse length
    - NC accelerator
- **Cyclotrons**
  - **PSI – separated sector (1974)**
    - Original design was for 100 μA
    - From 72 to 590 MeV
    - 1.8 mA average current
    - Beam losses at extraction < 1 μA
    - Plans for further upgrade (new cavities)
- **Both linac and cyclotrons were considered as possible ADS drivers**
  - **No fundamental obstacles** have been found so far **for a linac** to deliver ~100 mA at 1 GeV or more
  - **1 GeV and few mA** are considered as limiting values **for a cyclotron** (multistage): **possible for the demonstrator, not for the burner**





# "Unusual" Features needed by ADS-class accelerators

- A reactor should not have more than a hundred "scram's" in its life time
  - only "some" accelerator trips per year !!
  - a performance gain of 2 -3 orders of magnitude is needed !
- The beam losses in the accelerator should be very low in order to avoid activation
  - max some  $10 \mu\text{Sv/h}$ , one hour after shutdown, for hands-on maintenance
  - $\Delta I/I = 10^{-8} - 10^{-9} / \text{m} !!$

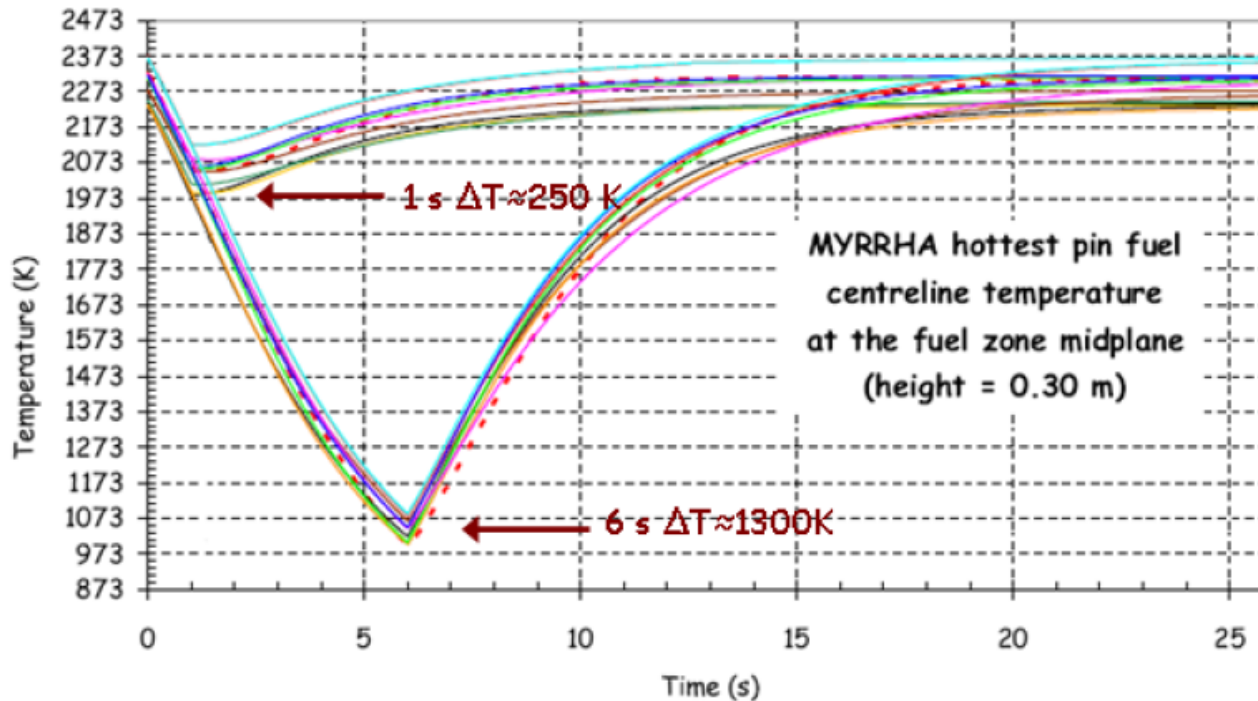

- All the reliability requirements for the ADS accelerator is linked to the need to avoid high thermal stresses in the reactor materials to minimize the fatigue and keep reasonable lifetime



# Reliability Example - CEBAF

## Lost Time Totals June '97-May '01

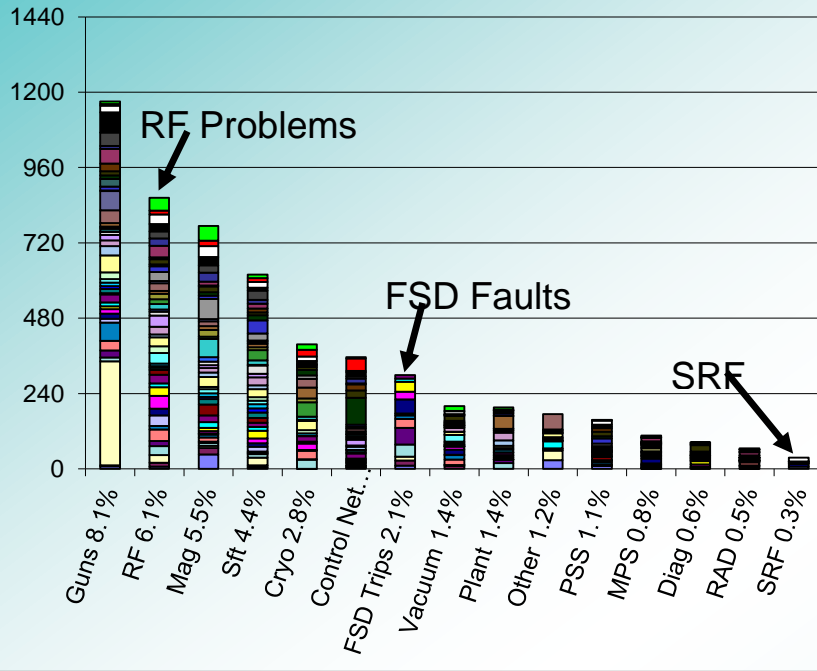

## Lost Time Totals FY 2001

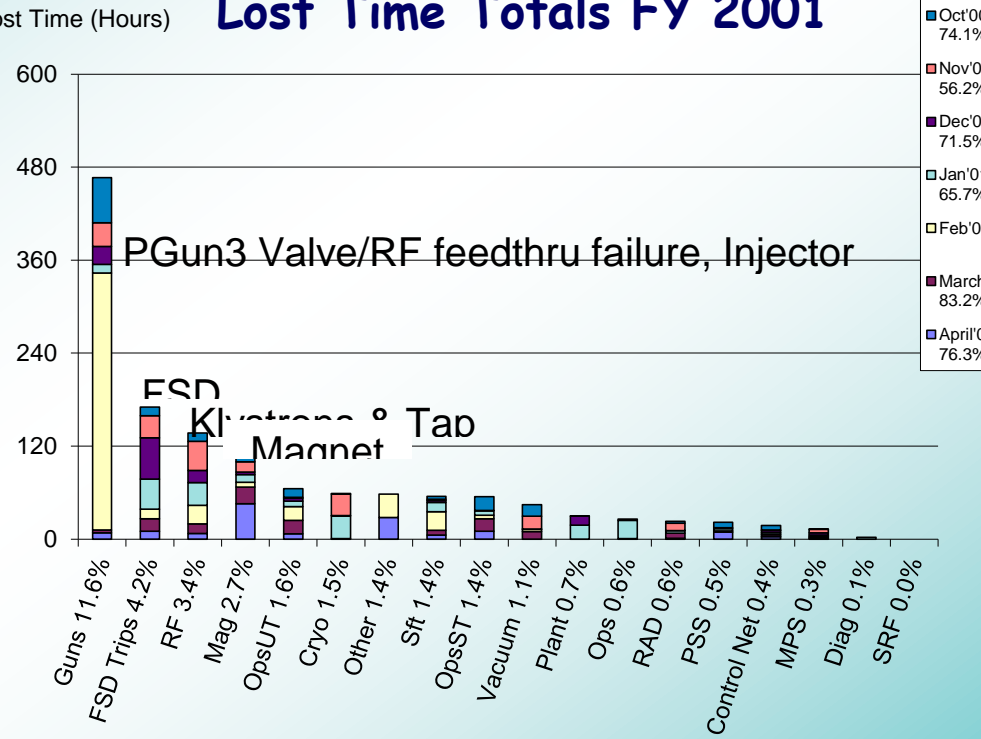

- Reliability must be improved for ADS applications
- The SC linac is modular and allows: overdesign, redundancy and "spare-on-line"
- Fast dedicated control electronics is crucial
- Beam can stay "on" when the linac is resetting itself to use spare-on line
- SC cavity technology proved to be the minor concern



# Reliability Example - SNS

## Down Time – Pareto Chart for FY09-1 & 2

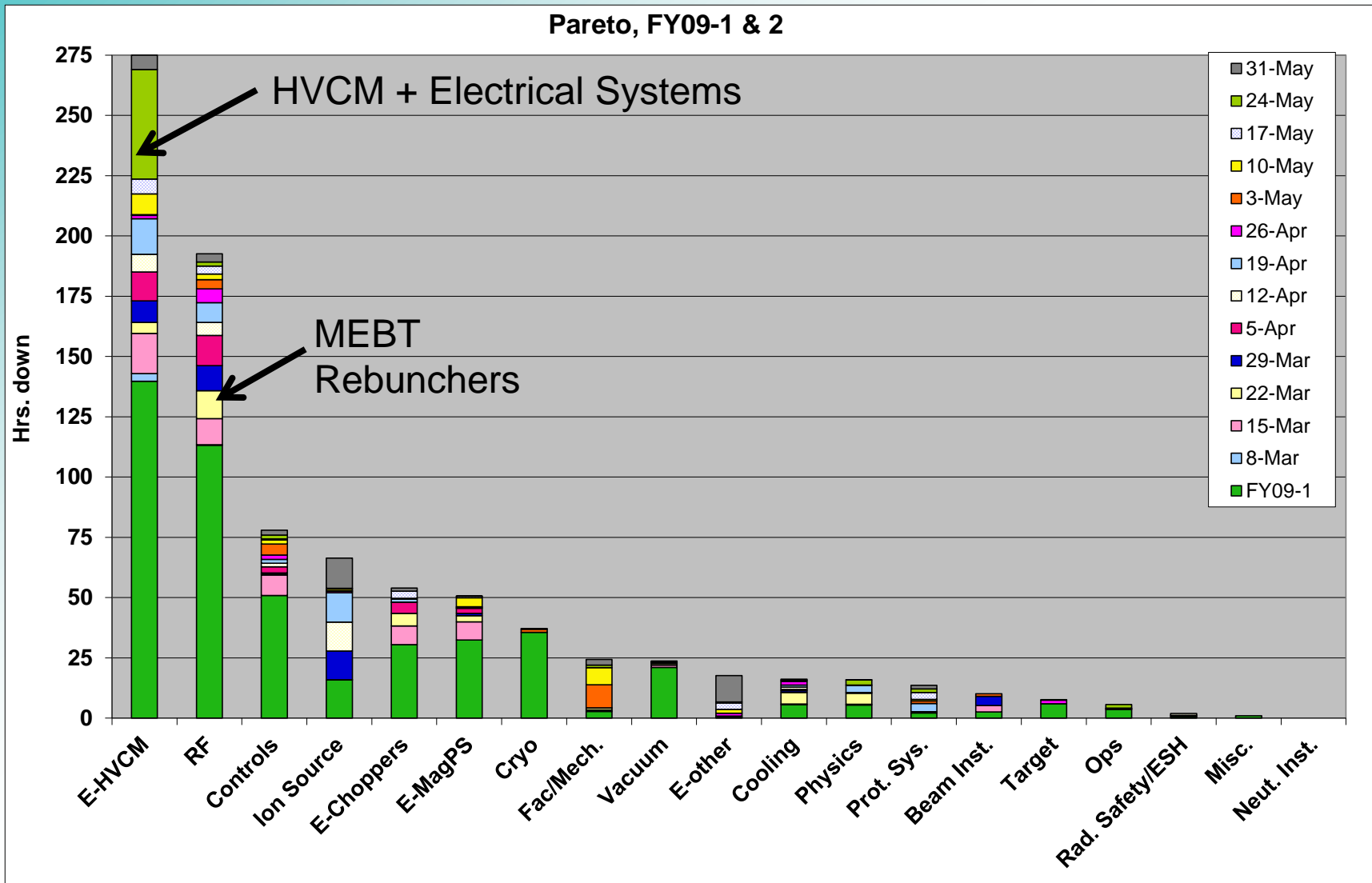



# Experimental ADS : reference design

**Superconducting linac:** Highly modular and upgradeable (same concept for prototype & industrial scale) ; Excellent potential for reliability ; High efficiency (optimized operation cost)

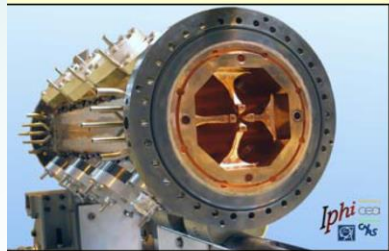
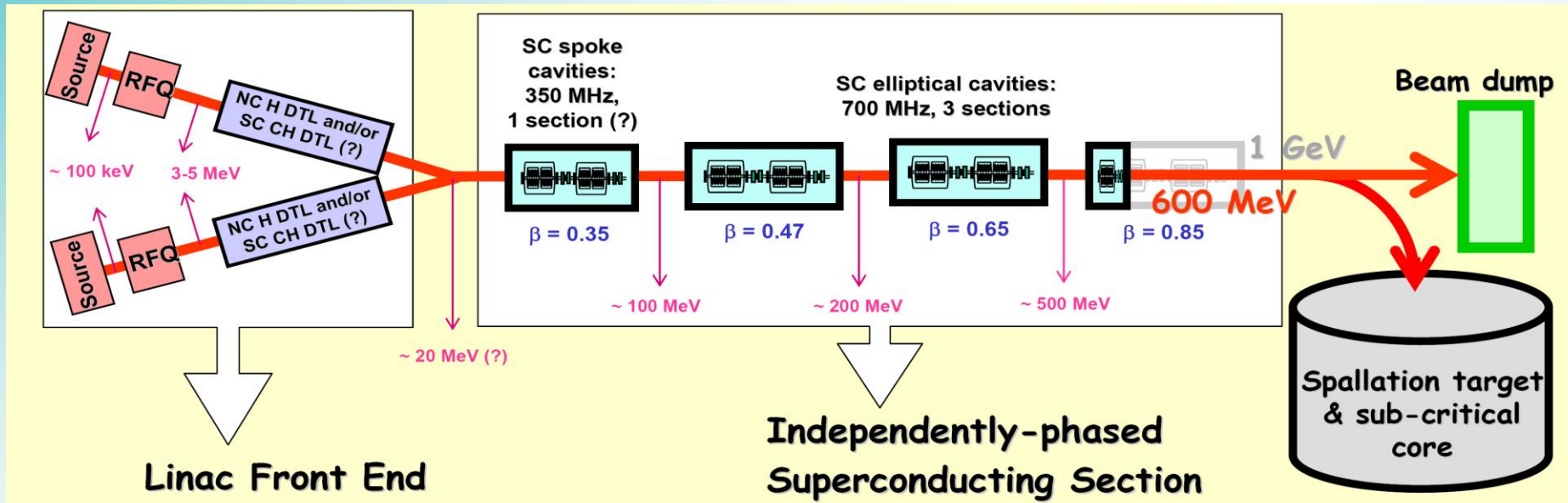



# Realibility guidelines

- **Beam trips longer than 1 sec are forbidden** to avoid thermal stresses & fatigue on the ADS target, fuel & assembly : less than 5 per 3-month operation cycle (XT-ADS)
  
- **Reliability guidelines have been followed during the ADS accelerator design**
  1. Strong component design & derating
    - All components are derated with respect to technological limitations
    - For every linac main component, a prototype is being designed, built and tested within the EUROTRANS programme
  2. Inclusion of redundancies in critical areas
    - Front-end duplication, solid-state RF power amplifiers where possible...
  3. Capability of fault-tolerant operation
    - Expected in the highly modular superconducting RF linac (from ~20 MeV)
    - Implies reliable and sophisticated digital RF control systems with preset set points for implementation



# Reliability Analysis in PDS-XADS

CONTRACT N°: FIKW-CT-2001-00179 ISSUE CERTIFICATE	FP5									
<b>PDS-XADS</b> <b>Preliminary Design Studies of an Experimental Accelerator-Driven System</b>										
<b>Workpackage N° 3</b> Identification: N° DEL/03/057                      Revision: 0 <b>Potential for Reliability Improvement and Cost Optimization of Linac and Cyclotron Accelerators</b>										
Dissemination level: RE Issued by: INFN Reference: INFN/TC_03/9 (July, 23 <sup>rd</sup> , 2003) Status: Final										
<b>Summary:</b> This document identifies the suitable design strategies that have been followed in order to meet the reliability and availability specifications for the XADS accelerator outlined in Deliverable 1. The document describes also how these strategies can be applied in the different components of the XADS accelerator design, and how design iterations can lead to reliability improvements. The Failure Mode and Effect Analysis (FMEA) methodology has been used on the suggested design for highlighting the reliability critical areas. Finally, a first rough cost estimation of the XADS accelerator is also provided.										
23/07/2003	<table border="1" style="width: 100%; border-collapse: collapse;"> <tr> <td style="width: 25%;">Paolo Pierini, INFN</td> <td style="width: 25%;">Alex C. Mueller, CNRS</td> <td style="width: 25%;">Bernard Carlucc, Framatome ANP SAS</td> </tr> <tr> <td style="text-align: center;"></td> <td style="text-align: center;"></td> <td style="text-align: center;"></td> </tr> <tr> <td style="text-align: center;">RESPONSIBLE Name/Company Signature</td> <td style="text-align: center;">WP LEADER Name/Company Signature</td> <td style="text-align: center;">COORDINATOR Name/Company Signature</td> </tr> </table>	Paolo Pierini, INFN	Alex C. Mueller, CNRS	Bernard Carlucc, Framatome ANP SAS				RESPONSIBLE Name/Company Signature	WP LEADER Name/Company Signature	COORDINATOR Name/Company Signature
Paolo Pierini, INFN	Alex C. Mueller, CNRS	Bernard Carlucc, Framatome ANP SAS								
RESPONSIBLE Name/Company Signature	WP LEADER Name/Company Signature	COORDINATOR Name/Company Signature								
DATE										

- Assessments using the « Failure Modes and Effects Analysis » (FMEA) method

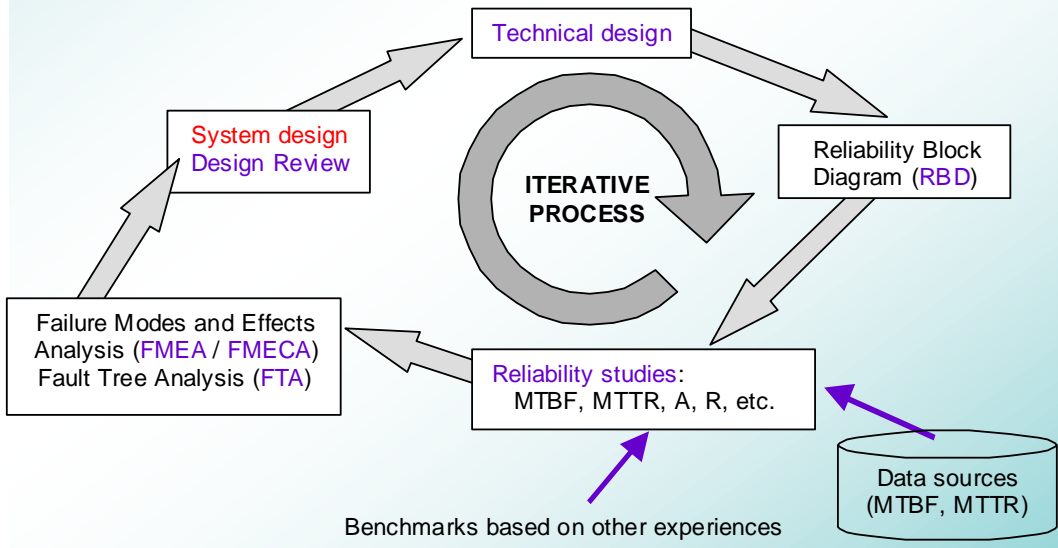

- Reliability engineering is a discipline for estimating, predicting and controlling the probability of occurrence of system faults



# Reliability Analysis going on in EUROTRANS

## Classical linac

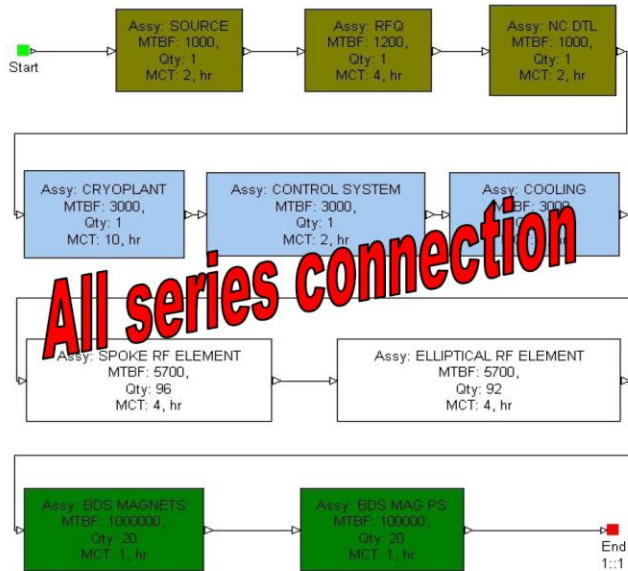

**All series connection**

System MTBF	31.19 hours
Nb of failures (3 months)	<b>70.23</b>
Steady State Availability	86.6 %

## ADS linac, optimized for reliability

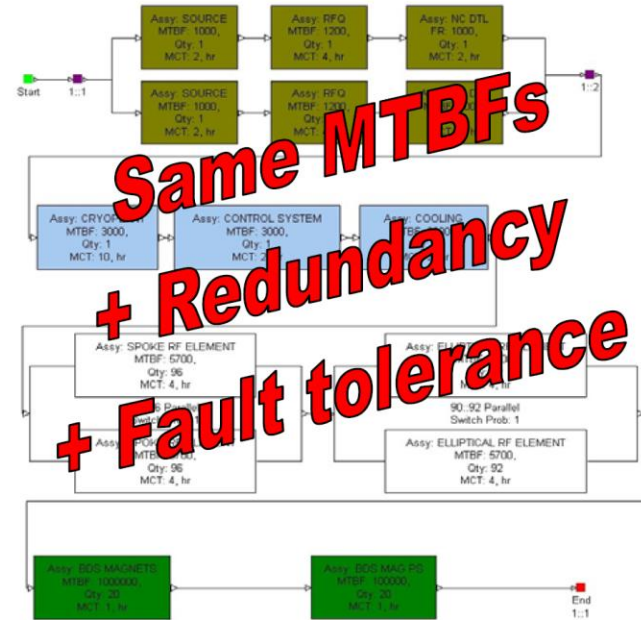

System MTBF	757.84 hours
Nb of failures (3 months)	<b>2.89</b>
Steady State Availability	99.5 %

*Preliminary reliability estimations by P. Pierini, INFN*



# The Fault Tolerant Accelerator

**Fault-tolerance = ability to loose a RF cavity (or Q-pole) without loosing the beam**

- Based on a fast local **compensation method**, possible thanks to the independently-phased linac

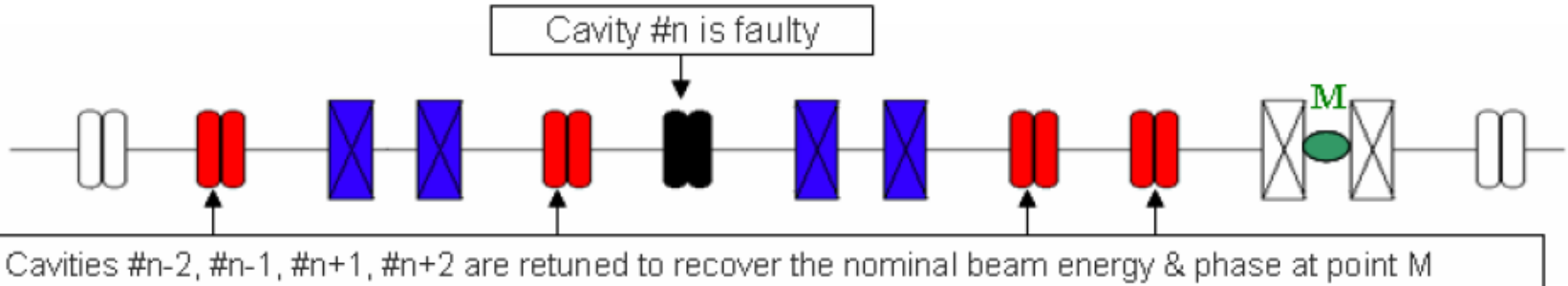

# faulty cavity	section	Final energy	Emittance growth (%)		# of retuned cavities (before + after)	Max $\Delta E_{acc}$ (%)	Max $E_{pk}$ (SP) or $B_{pk}$ (EL)	Max $\Delta Power$ (%)	# retuned quads (before + after)
			Trans.	Long.					
0	-	Nominal	+ 5 %	0 %	-	-	-	-	-
1	SP 0.15	Nominal	+ 7 %	+ 4 %	<b>0 + 4</b>	+ 67 %	19 MV/m	+ 67 %	0 + 4
4	SP 0.15	Nominal	+ 9 %	+ 4 %	<b>3 + 3</b>	+ 46 %	15 MV/m	+ 35 %	2 + 4
62	SP 0.35	Nominal	+ 6 %	0 %	<b>2 + 2</b>	+ 26 %	31 MV/m	+ 28 %	2 + 2
63	SP 0.35	Nominal	+ 5 %	+ 1 %	<b>3 + 2</b>	+ 25 %	31 MV/m	+ 27 %	2 + 2
98	EL 0.47	Nominal	+ 6 %	0 %	<b>3 + 2</b>	+ 23 %	62 mT	+ 31 %	4 + 2
109	EL 0.47	Nominal	+ 6 %	0 %	<b>3 + 3</b>	+ 20 %	60 mT	+ 28 %	4 + 2
174	EL 0.65	Nominal	+ 5 %	0 %	<b>3 + 3</b>	+ 18 %	59 mT	+ 22 %	4 + 2
175	EL 0.65	Nominal	+ 5 %	0 %	<b>4 + 4</b>	+ 17 %	59 mT	+ 18 %	4 + 2
186	EL 0.85	Nominal	+ 7 %	0 %	<b>6 + 1</b>	+ 21 %	61 mT	+ 33 %	2 + 2
187	EL 0.85	Nominal	+ 6 %	0 %	<b>7 + 0</b>	+ 25 %	63 mT	+ 37 %	2 + 2

**Capability of fault-tolerant operation** due to the highly modular superconducting RF linac (from ~20 MeV) and due to the availability of reliable and sophisticated digital RF control systems





# The Fault Tolerant Accelerator

- Two **fast failure recovery scenarios** ( $\ll 1$  sec) have been identified & checked on the beam dynamics point of view, both based on:
  - Fast fault detection
  - Fast update and tracking of the field/phase set-points (preset)
  - Adequate management of the tuner of the failed cavity
- Requires up to 30% **margins** on RF fields and powers
- **Requires the use of digital LLRF control systems**
  - Heavy R&D on-going on this topic

**Note -> Fault recovery system** in real operation at the SNS SC linac (US) (global compensation method, “high” energies, “slow” retuning)



**FPGA  
based  
DIGITAL  
SYSTEM**



# ADS : Reliability & Maintenance

- The maintenance strategy is presently under investigation, assuming 3 months of operation / 1 month of maintenance

PDS-XADS-WP3 Deliverable 48 Chapter 4 4.3.1 H+ source			Severity Ranking Tables										
			Local effect		Effect on beam								
			0: No effect		0: Beam with nominal parameters on target								
		1: Functioning with reduced performance		1: Beam with wrong parameters on target									
		2: Loss of function		2: No beam on target									
Main Items			Function	Failure Mode	Severity rank			Preventive action			Curative action		Rem.
					local	beam	action	freq.	time of int.	action	time of int.		
Boron nitride discs				Wear	1	1	Replace	6 months	24 H	Replace	24H		
Vacuum pumps				Wear	1	2	Regenerate	24 months					
				Out of order	2	2	-			Replace	8H		
Power supply filters				Get dirty	0	0	Clean	3 months	few min				
Power supply				Aging	0	0	Overhaul	24 months	few weeks			Use spare while overhauling	
Cooling (water): filters, pumps...				Wear / dirty	0	0	Clean						
Plasma electrode				Aging	1	1	Replace	12 months	24H				
Magnetron				Out of order	2	2	Replace	24 months	2H	Replace	2H	Replace "before MTBF"	
HV power supply				Out of order	2	2	Oil changing	24 months	8H	Replace	8H		
Extraction electrodes				Aging	1	1	Replace	24 months	48H				
Security devices :													
Water flow controller				get dirty			cleaning	12 months	30 min	Replace	2H		
Temperature controller				Out of order			Systematic tests	12 months	few min	Replace	8H	could be doubled	
Emergency stop				Out of order			Systematic tests	12 months	1 H	Replace	1 H		
DGPT				Out of order			Systematic tests	12 months	1 H	Replace	8 H		



# Prototyping of accelerator components



## Spoke cavities



## Elliptical cavities

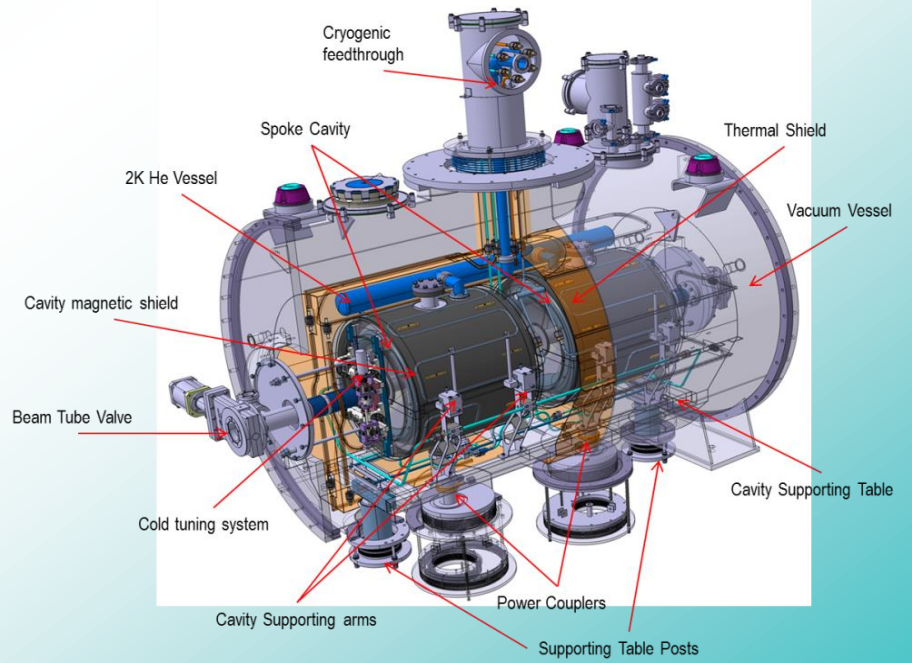
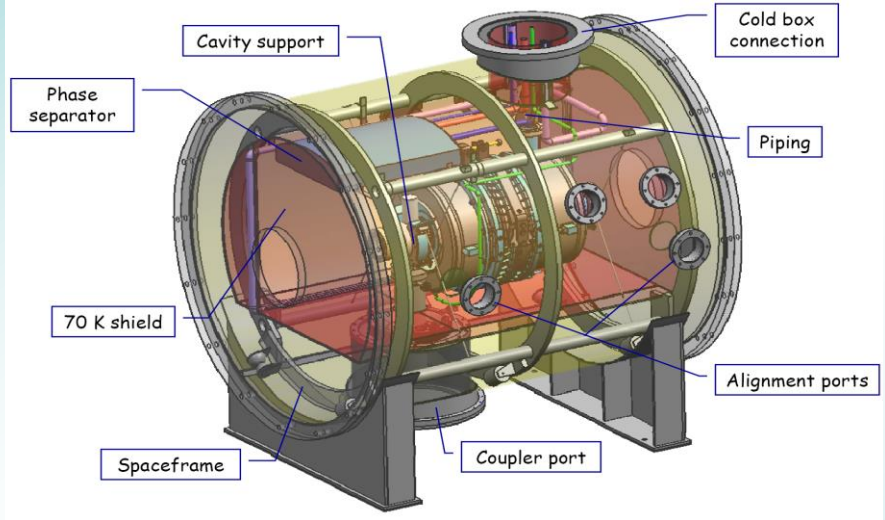



# Decision for the construction of MINERVA

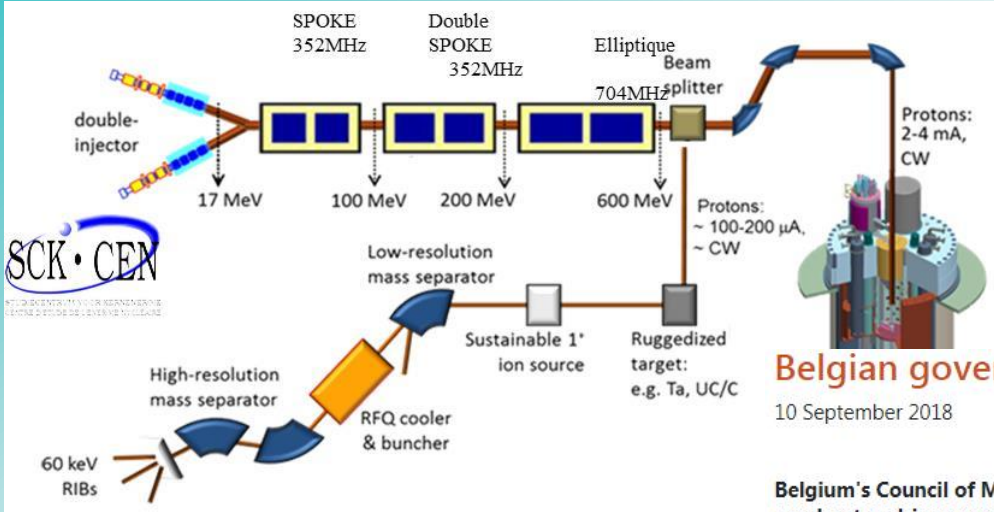

## Belgian government approves funding for Myrrha

10 September 2018



Belgium's Council of Ministers has approved EUR558 million (USD646 million) in funding for the Myrrha accelerator-driven research reactor at the Belgian Nuclear Research Centre's (SCK-CEN's) site in Mol.



An artistic impression of how Myrrha may appear (Image: SCK-CEN)

MINERVA = MYRRHA first stage (100 MeV)



# High Power Proton Accelerator as an irradiation tool for material testing: the IFMIF project



# The IFMIF accelerator

Objective of the IFMIF project: characterization of materials with intense neutrons flux ( $10^{17}$  n/s) for the future Fusion Reactor DEMO (~150 dpa)

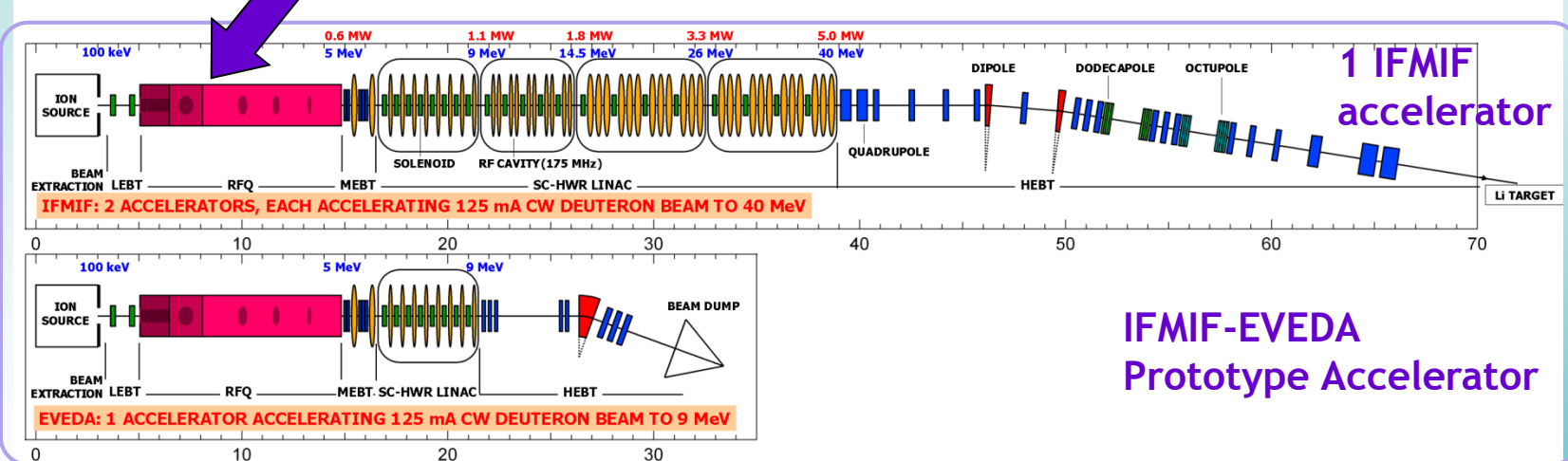
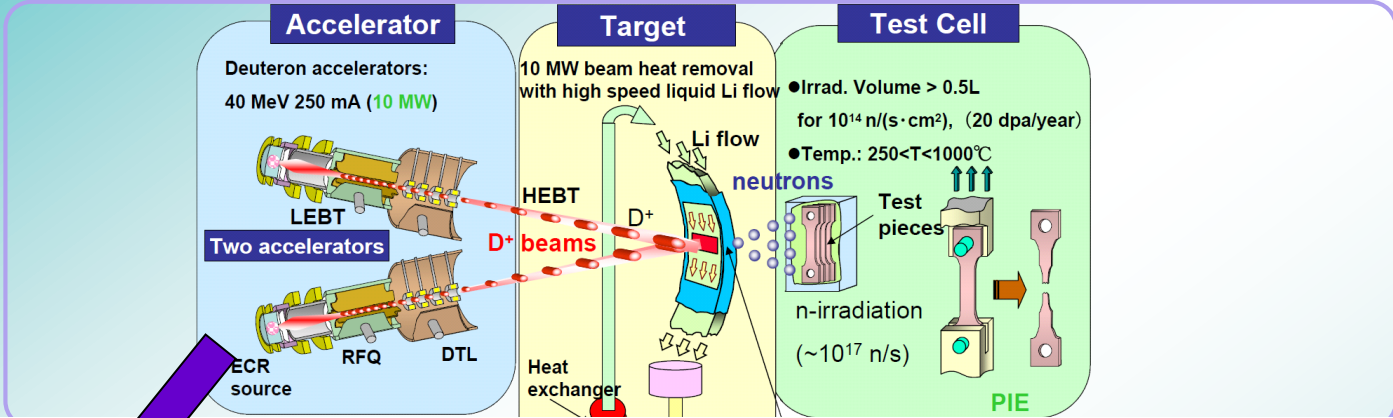

Collaboration for Accelerator: CEA (FR), INFN (IT), CIEMAT (SP), SCK-CEN (BE), JAEA (JA)  
In the framework of an agreement between Euratom & Government of Japan,  
the program IFMIF/EVEDA has been launched in June 2007



# The IFMIF accelerator

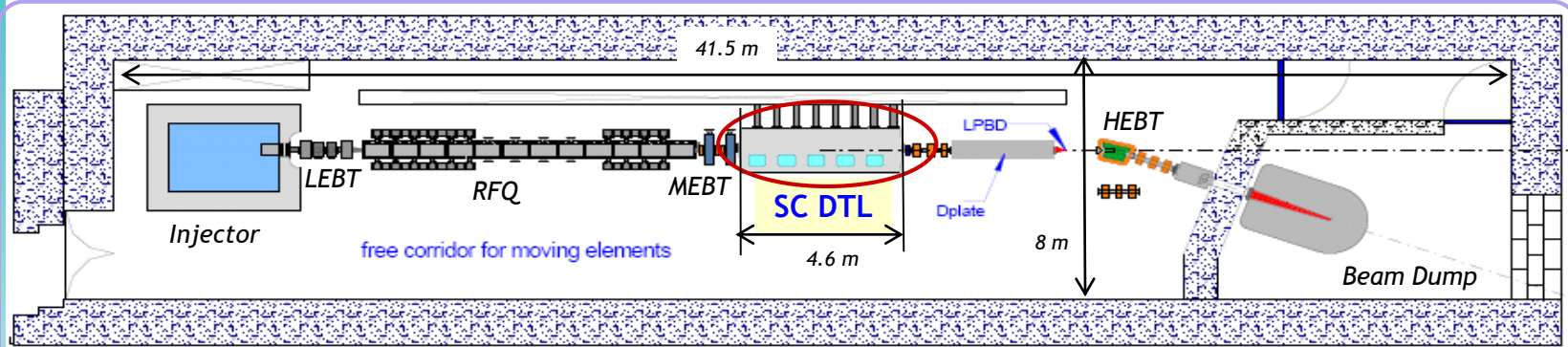

EVEDA General layout

## Objectives of the SC Drift Tube Linac

- Transport and accelerate a deuteron beam of  $I=125$  mA @ 175 MHz, CW,
- Energy from 5 MeV up to 9 MeV for EVEDA Acc. prototype, and up to 40 MeV for IFMIF,
- Good performances in terms of transverse and longitudinal emittances and w/o beam loss

### ⇒ SC DTL of 4.6 m long, equipped with:

- 8 superconducting Half Wave Resonator (HWR low- $\beta = 0.094$ ), working at 4 K, with a moderate accelerating field  $\sim 4.5$  MV/m max, and an appropriate tuning system (frequency range  $\pm 50$  kHz)
- 8 RF power couplers, working in TW, and providing to HWRs the RF power of 70 kW per coupler (EVEDA cryomodule) and 200 kW per coupler for IFMIF cryomodules
- 8 Solenoids Packages, including focusing solenoid, H&V steerers and Beam Position Monitors (BPMs)
- Cryostat: supports, cryogenic distribution, alignment, vacuum, shielding, instrumentation, etc ...



# The IFMIF accelerator

