

Dark Axion Portal

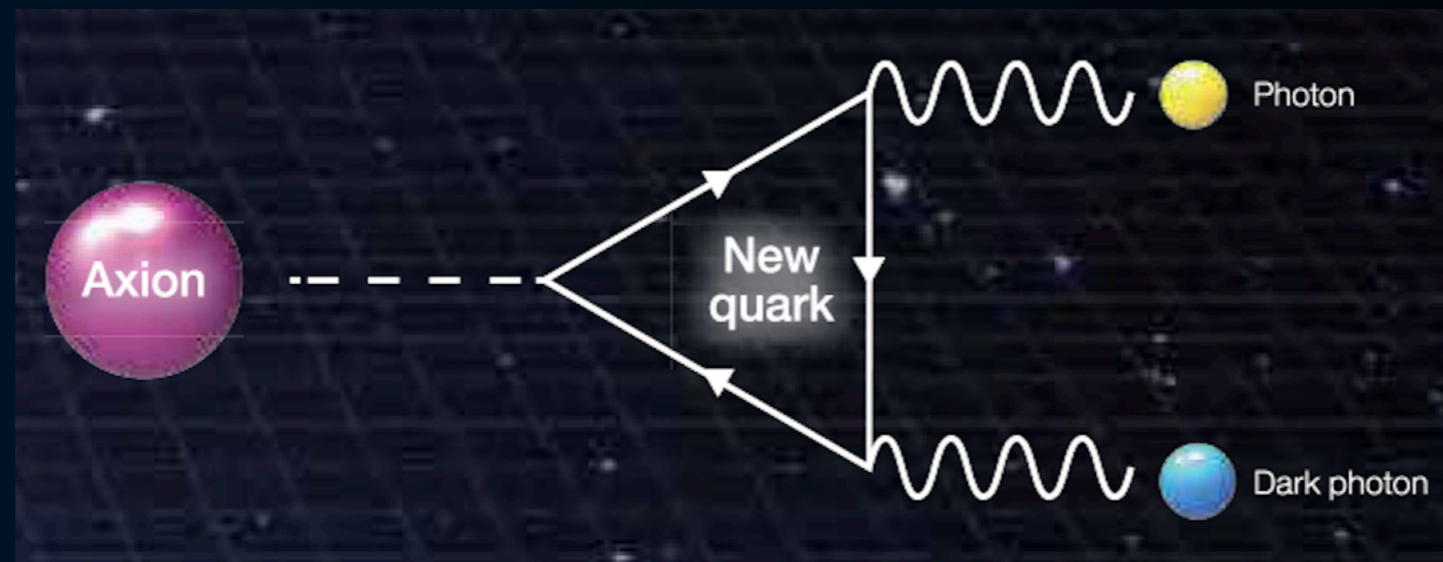

Hye-Sung Lee
KAIST

IBS-PNU Workshop on Physics beyond the Standard Model
Busan / December 4, 2019

We live in a Dark World

Total Universe Energy

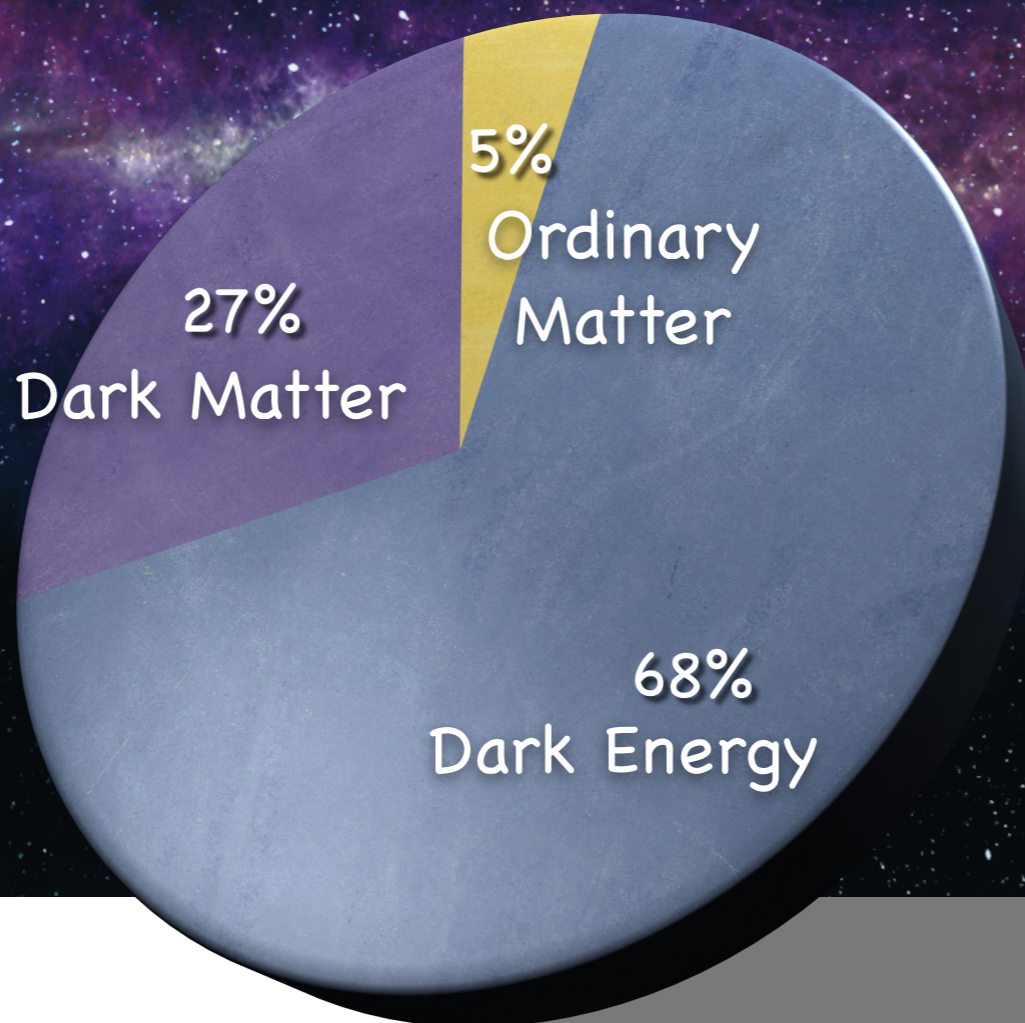

$$\begin{aligned}\nabla \cdot \vec{E} &= \rho \\ \nabla \times \vec{E} &= -\frac{\partial \vec{B}}{\partial t} \\ \nabla \cdot \vec{B} &= 0 \\ \nabla \times \vec{B} &= \vec{J} + \frac{\partial \vec{E}}{\partial t}\end{aligned}$$

Bright sector

Dark sector

We live in a Dark World

Total Universe Energy

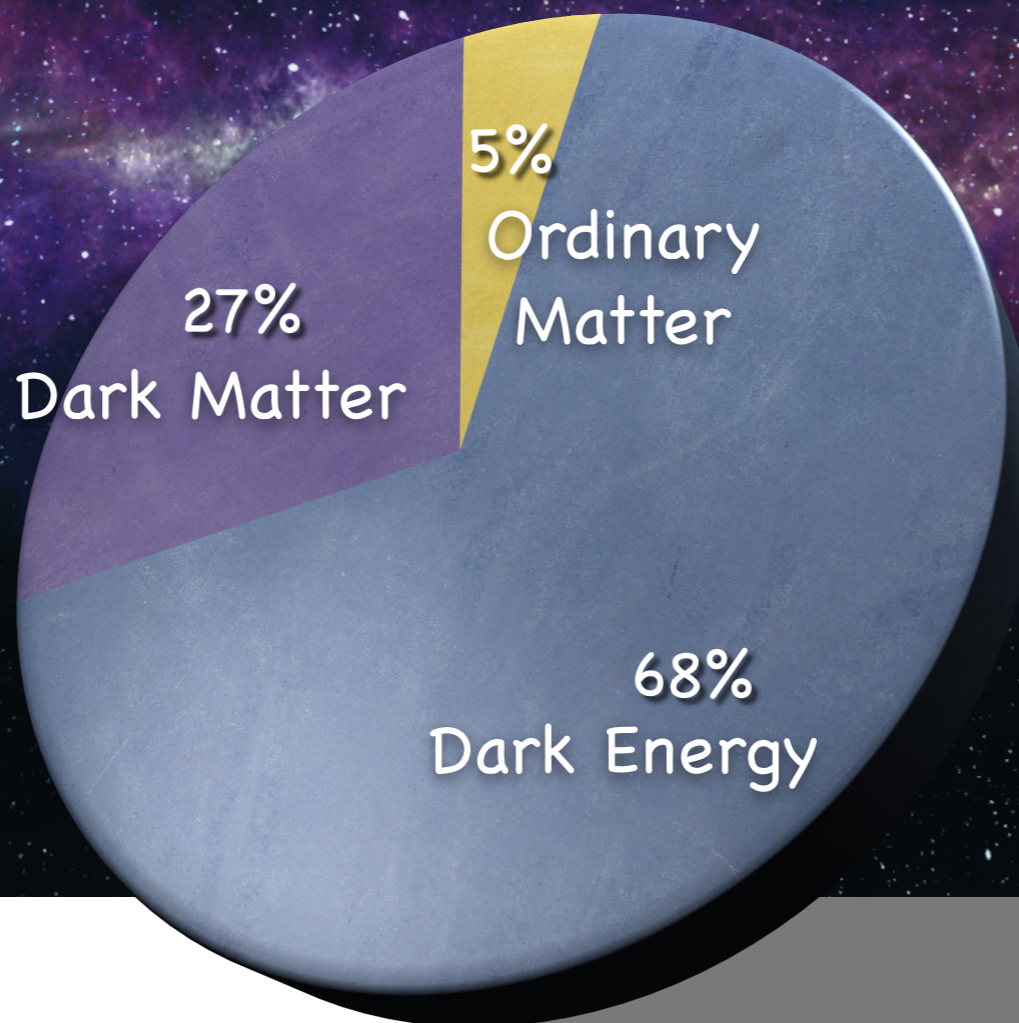

Dark Sector

Dark matter
 Dark Higgs
 Dark gauge boson
 ...

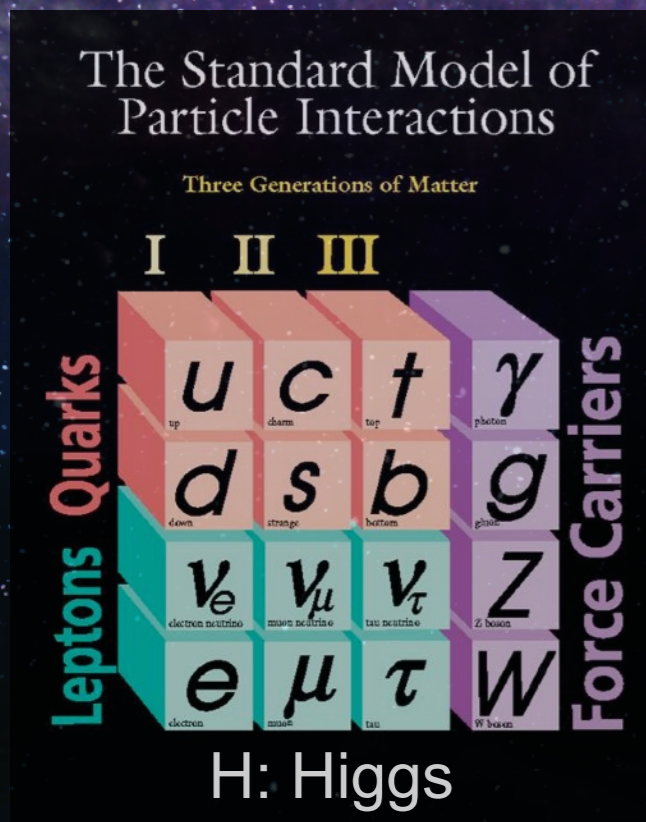

$$\begin{aligned} \nabla \cdot \vec{E} &= \rho \\ \nabla \times \vec{E} &= -\frac{\partial \vec{B}}{\partial t} \\ \nabla \cdot \vec{B} &= 0 \\ \nabla \times \vec{B} &= \vec{J} + \frac{\partial \vec{E}}{\partial t} \end{aligned}$$

Bright sector

Dark sector

The dark sector particles can be light.



Portals

Standard Model

Dark Sector

Dark matter
Dark gauge boson
Dark Higgs
RH neutrino
Axion
...

**Through the portal,
two separate sectors
can communicate
with each other.**

F, γ : photon
 Z', γ' : dark photon
 a : axion

Portals

(i) Vector Portal

$$\frac{\varepsilon}{2} F_{\mu\nu} Z'^{\mu\nu}$$

Photon (γ)  Dark photon (γ')

(ii) Axion Portal

$$\frac{G_{a\gamma\gamma}}{4} a F_{\mu\nu} \tilde{F}^{\mu\nu}$$

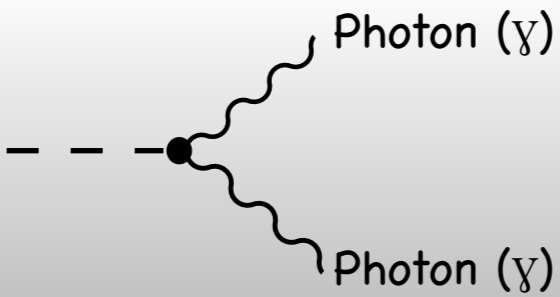
Axion (a)  Photon (γ)
Photon (γ)

(iii) Higgs Portal

$$\kappa |S|^2 |H|^2 + \mu S |H|^2$$

Higgs  Dark Higgs

(iv) Neutrino Portal

$$y LHN$$

Neutrino  Right-Handed neutrino



F, γ : photon
Z', γ' : dark photon
a : axion

Portals

(i) Vector Portal

$$\frac{\epsilon}{2} F_{\mu\nu} Z'^{\mu\nu}$$

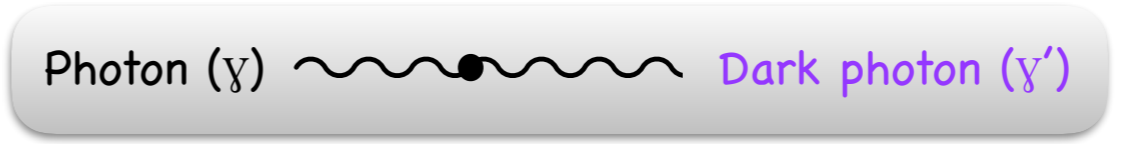

(ii) Axion Portal

$$\frac{G_{a\gamma\gamma}}{4} a F_{\mu\nu} \tilde{F}^{\mu\nu}$$

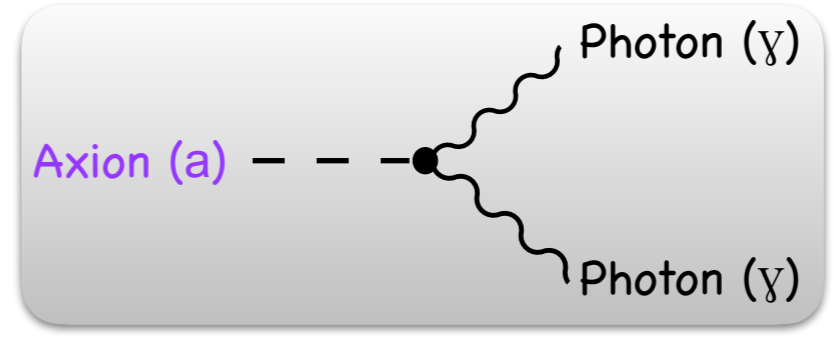

(iii) Higgs Portal

$$\kappa |S|^2 |H|^2 + \mu S |H|^2$$

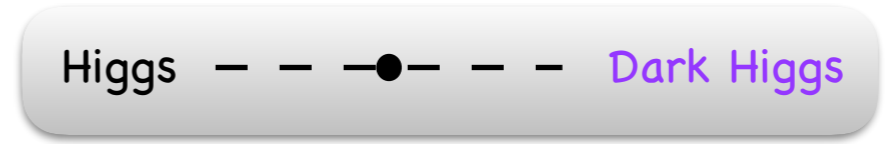

(iv) Neutrino Portal

$$y LHN$$



(v) Dark Axion Portal

[Kaneta, LEE, Yun (PRL 2017)]

$$\frac{G_{a\gamma\gamma'}}{4} a F_{\mu\nu} \tilde{Z}'^{\mu\nu} + \frac{G_{a\gamma'\gamma'}}{4} a Z'_{\mu\nu} \tilde{Z}'^{\mu\nu}$$

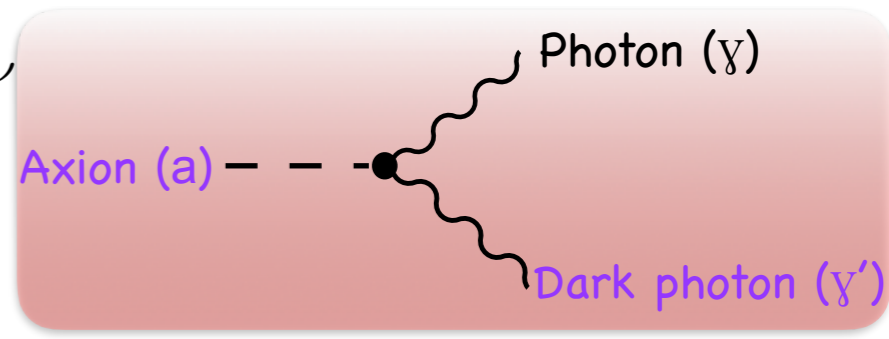

We introduce a new portal that connects Dark photon (Vector portal) and Axion (Axion portal) to our sector at the same time.

The new portal is not a simple product of Vector & Axion portals. (e.g. $G_{a\gamma\gamma'} \neq \epsilon G_{a\gamma\gamma}$)

Vector Portal

$$\frac{\varepsilon}{2} F_{\mu\nu} Z'^{\mu\nu}$$

Standard Model + Dark Force

Gauge symmetry = $SU(3)_C \times SU(2)_L \times U(1)_Y \times U(1)_{\text{dark}}$

It may interact with DM, but
SM particles have zero charges

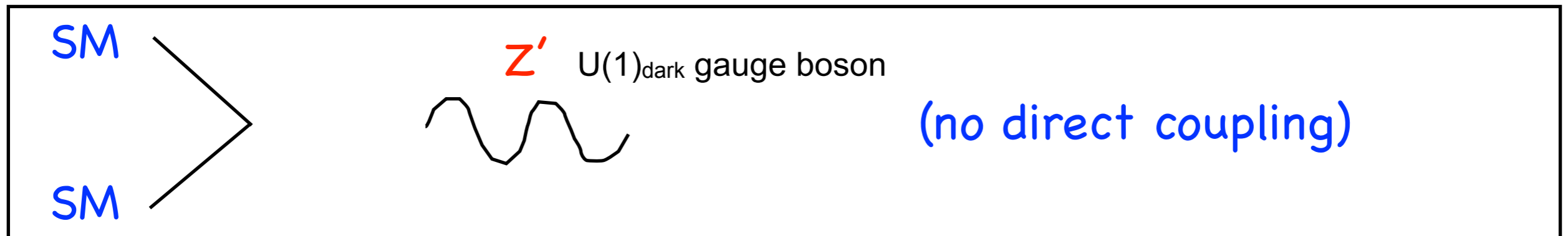

Z' can couple to SM particles **through kinetic mixing of $U(1)_Y$ & $U(1)_{\text{dark}}$.**

[Holdom (1986)]

$$\mathcal{L}_{\text{kin}} = -\frac{1}{4} B_{\mu\nu} B^{\mu\nu} + \frac{1}{2} \frac{\varepsilon}{\cos \theta_W} B_{\mu\nu} Z'^{\mu\nu} - \frac{1}{4} Z'_{\mu\nu} Z'^{\mu\nu}$$

$U(1)$ kinetic term (photon part)

→ **Maxwell's equations**

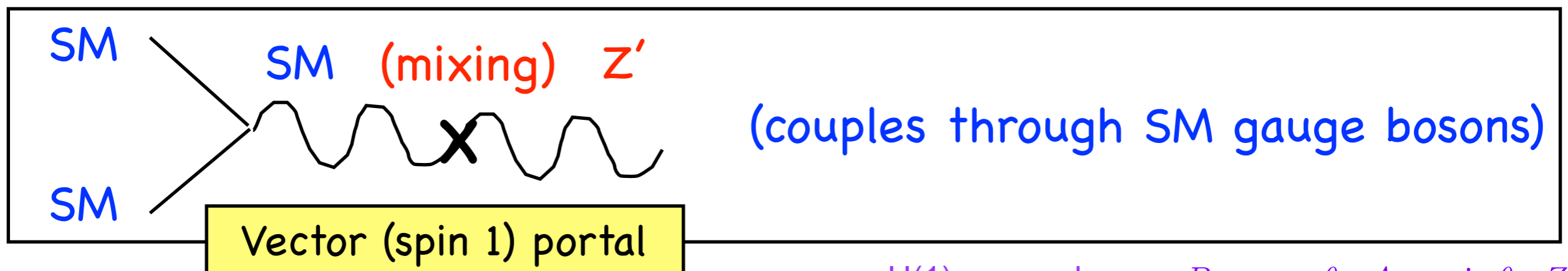

$U(1)_Y$ gauge boson: $B_\mu = \cos \theta_W A_\mu - \sin \theta_W Z_\mu$
(θ_W : Weinberg angle)

Visible/Invisible decay of Dark photon

2 main categories of Dark force search (in terms of the dominant decay modes) :

(i) “Dilepton Resonance” search Visible dark photon mode

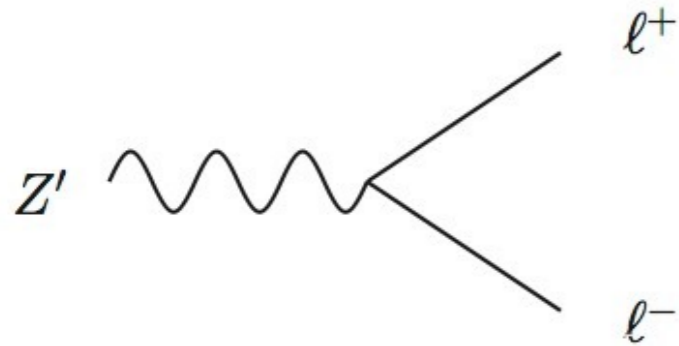

$Z' \rightarrow l^+l^-$ is the major decay mode in an ordinary scenario.

$$\Gamma(\gamma' \rightarrow e^+e^-) = \frac{\varepsilon^2 e^2}{12\pi} m_{\gamma'} \left(1 - \frac{4m_\chi^2}{m_{\gamma'}^2}\right)^{1/2}$$

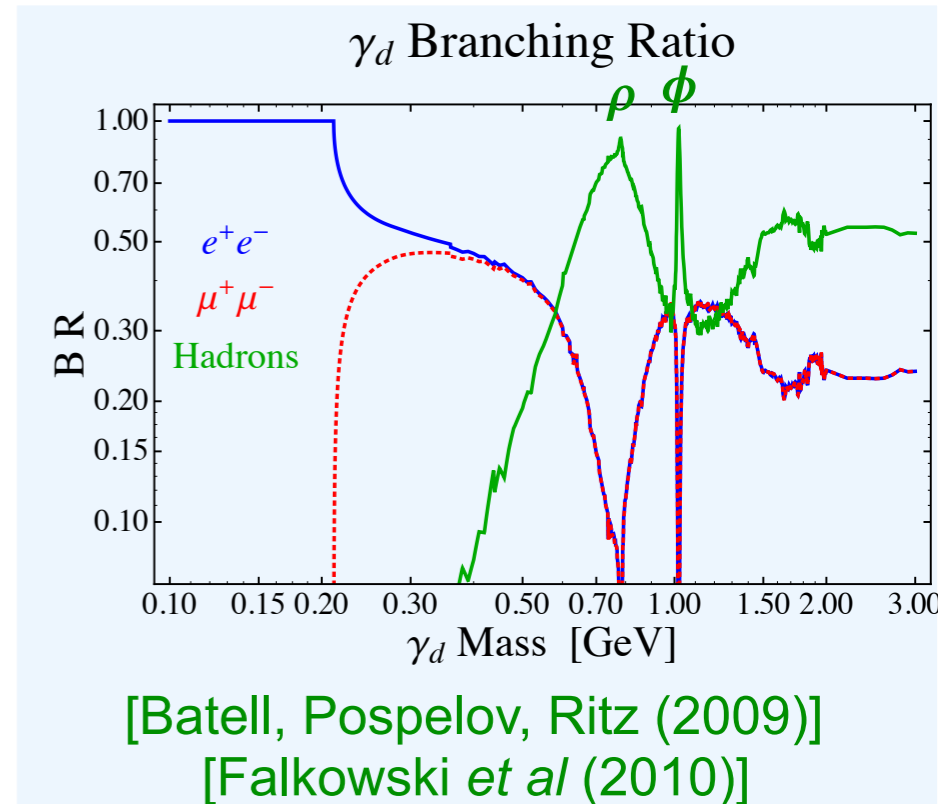

(ii) “Missing Energy” search Invisible dark photon mode

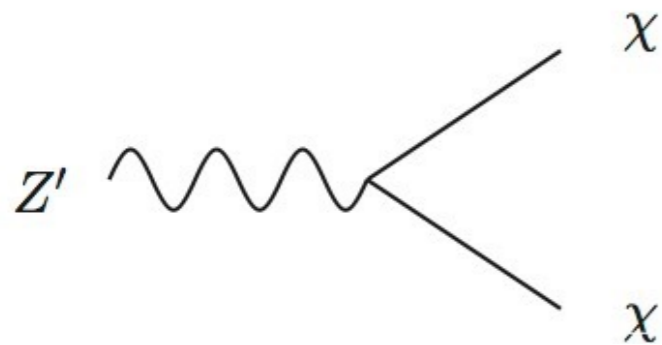

$Z' \rightarrow \chi\bar{\chi}$ is the major decay mode, if χ (**very light dark sector particle**) exists.

$\text{BR}(Z' \rightarrow \text{missing energy}) \approx 1$ is taken.

$$\Gamma(\gamma' \rightarrow \chi\bar{\chi}) = \frac{e'^2 D_\chi^2}{12\pi} m_{\gamma'} \left(1 - \frac{4m_\chi^2}{m_{\gamma'}^2}\right)^{1/2}$$

Dilepton searches for dark photon (Visible dark photon)

[Current constraints]

Photon (γ)  Dark photon (γ')

γ - γ' kinetic mixing
(vector portal)

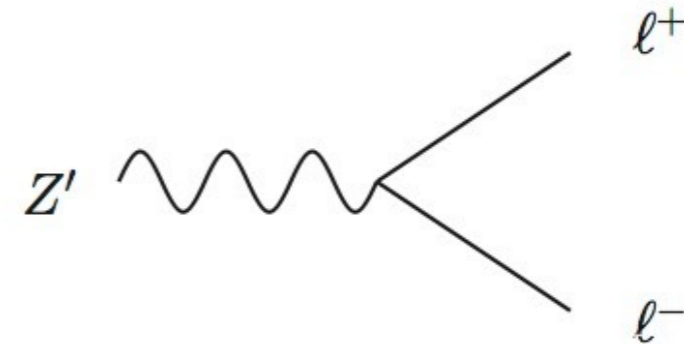
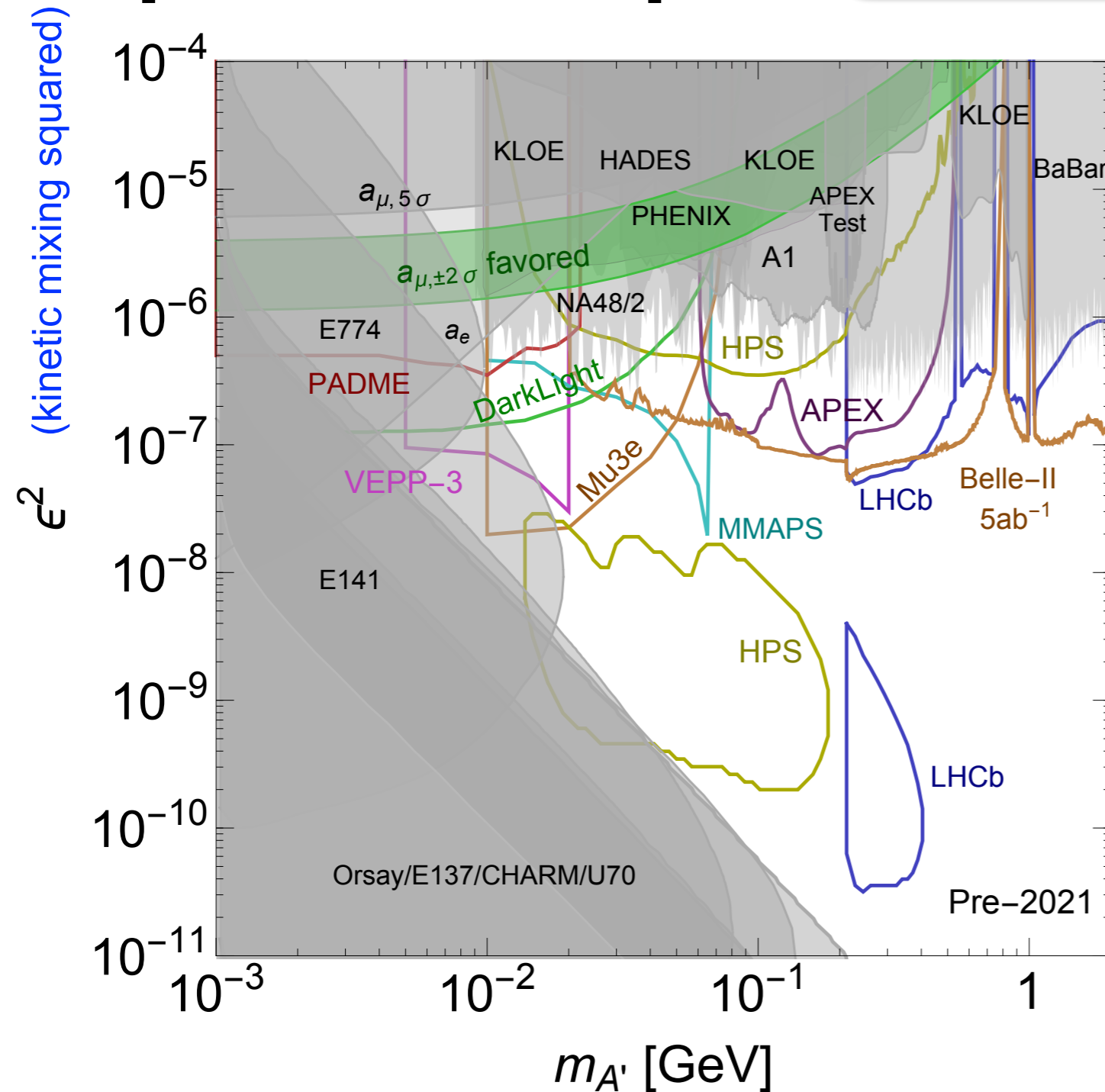

Mostly from the $Z' \rightarrow$ dilepton searches (e^+e^- or $\mu^+\mu^-$)

- (i) Electron, Muon $g-2$
- (ii) Beam-dumps
- (iii) Meson (quarkonium) decays
- (iv) e^+e^- collision (photon+ Z')
- (v) Fixed target experiments

The dark gauge boson is actively searched for in many experiments.

The vector portal is constrained to be small ($\epsilon \ll 1$).

Example: A' Experiment (APEX) at JLab - Hall A

[APEX Collaboration]

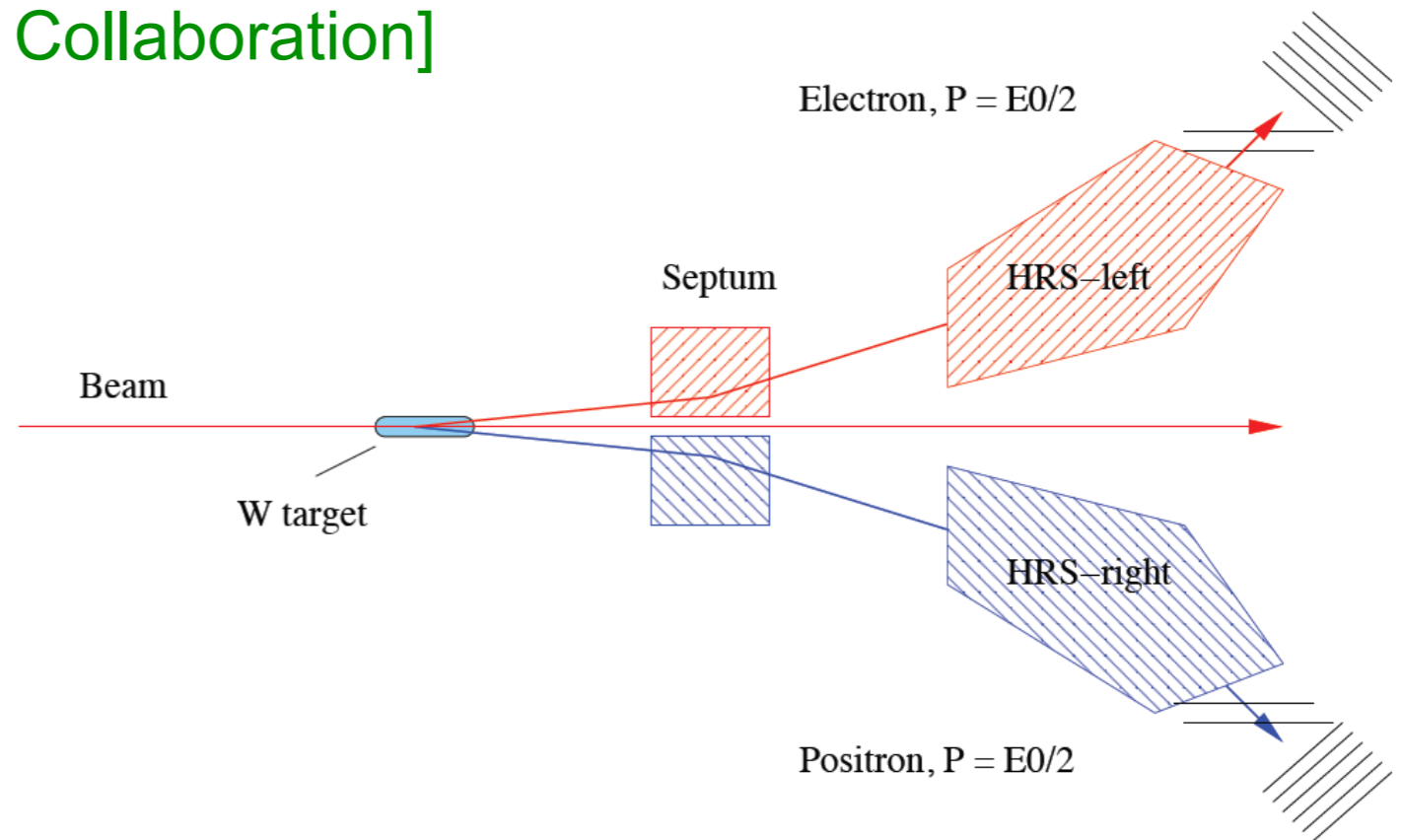
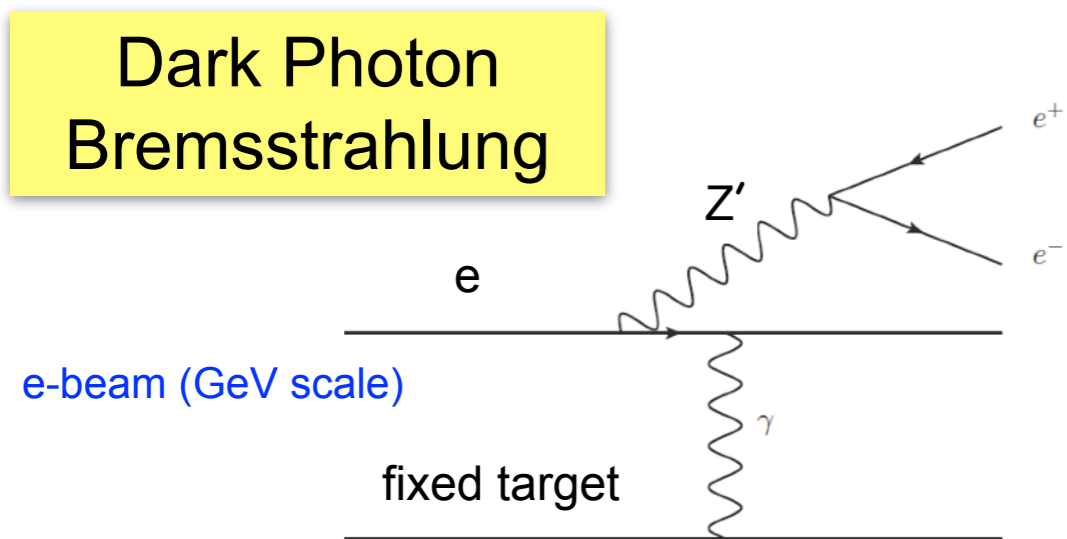

New Fixed target (Tantalium $Z=73$) experiment designed for direct Dark Photon production/detection.

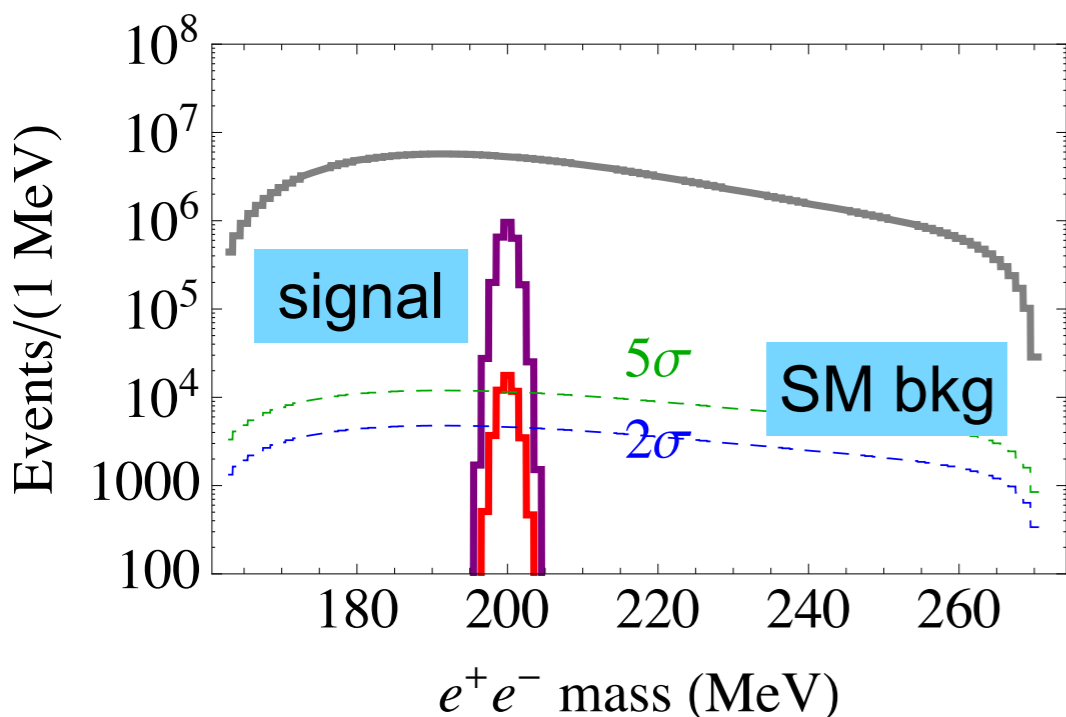

$Z' \rightarrow e^+e^-$ narrow resonance at Z' mass
(Direct bump search at Low-energy facility)

The *High Resolution Spectrometers (HRS)* at Hall A are used.

Missing energy searches for dark photon (Invisible dark photon)

[Current constraints]

Photon (γ)  Dark photon (γ')

γ - γ' kinetic mixing
(vector portal)

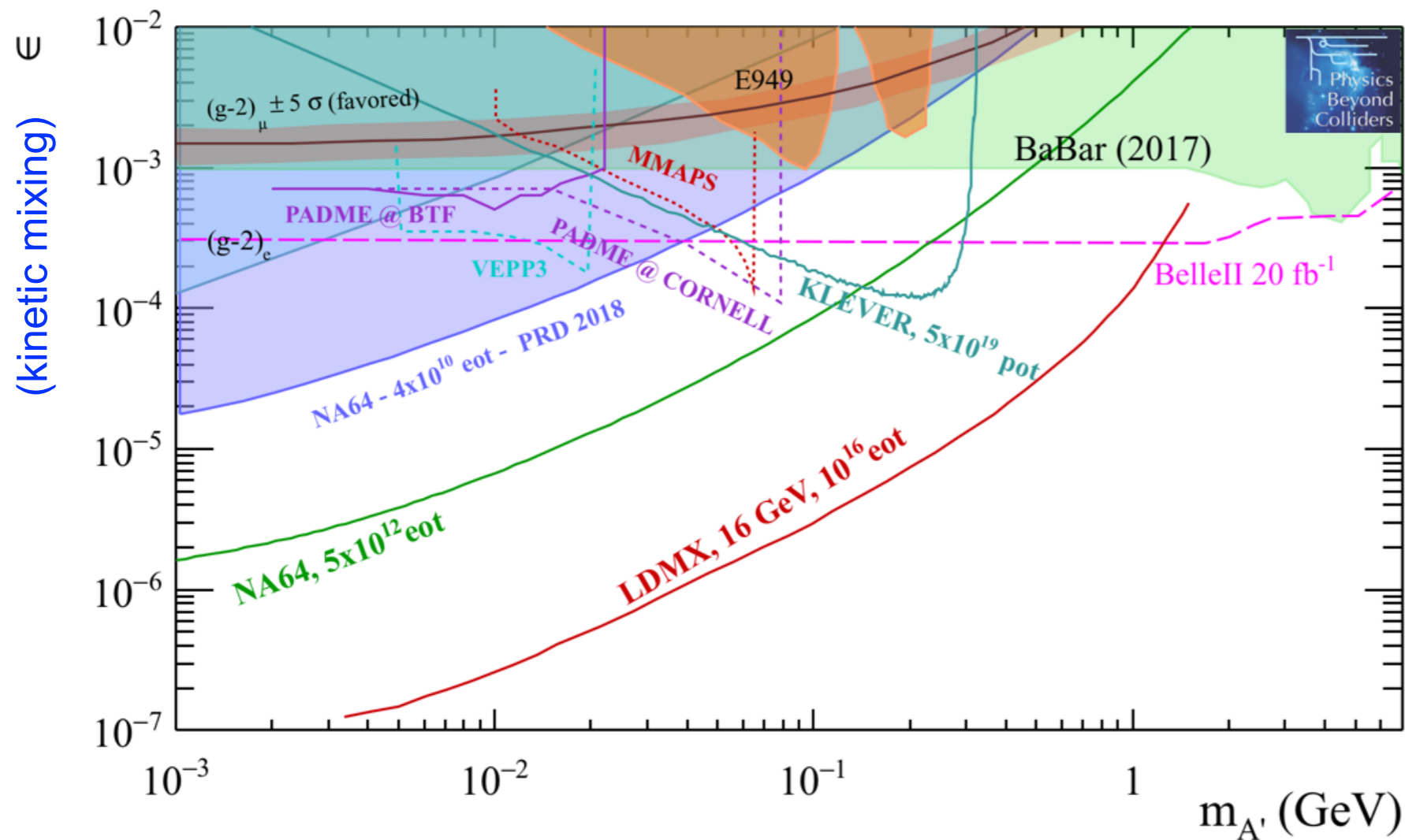

From Physics Beyond Colliders at CERN (arXiv:1901.09966)

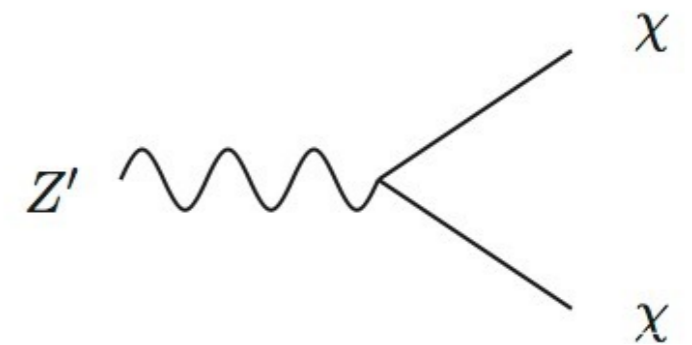

The invisible dark photon is also actively searched for in many experiments.

The vector portal is constrained to be small ($\epsilon \ll 1$) in this scenario too.

Example: NA64 (beam-dump for dark photon) at CERN SPS

[NA64 Collaboration]

CERN experiment
to test invisibly decaying Z'

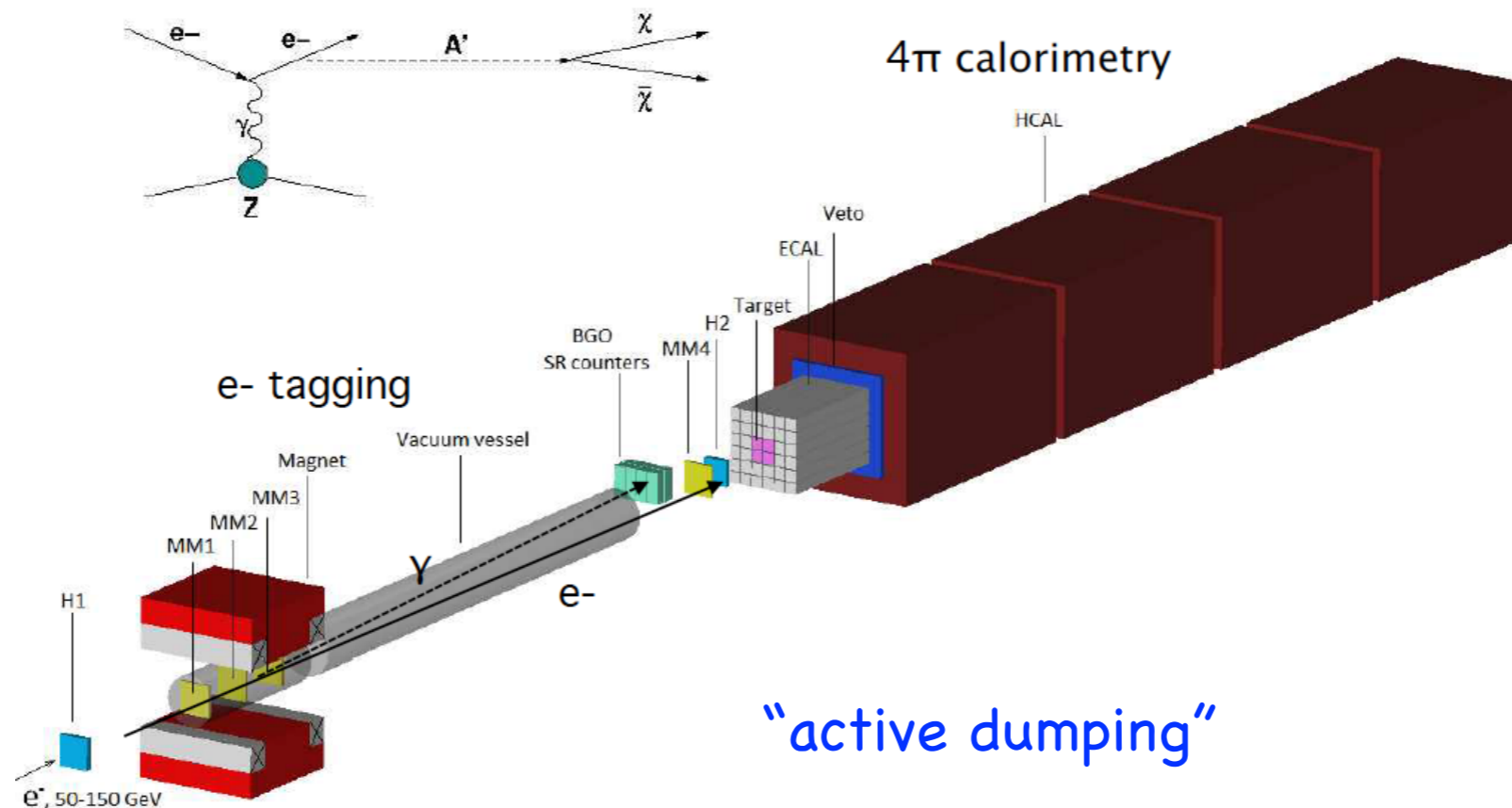

- (i) Primarily e^- -beam (~ 100 GeV). Ultimately EOT $\sim 10^{12}$.
- (ii) Detector is hermetic (catching all SM particles except for neutrinos) and measures total energy deposit.
- (iii) Test “energy loss” (Missing E) by invisibly decaying Z' . (Essentially BKG free.)
- (iv) Does not depend on unknown α_D (DM coupling).

Extended range of parameters of the Dark Photon

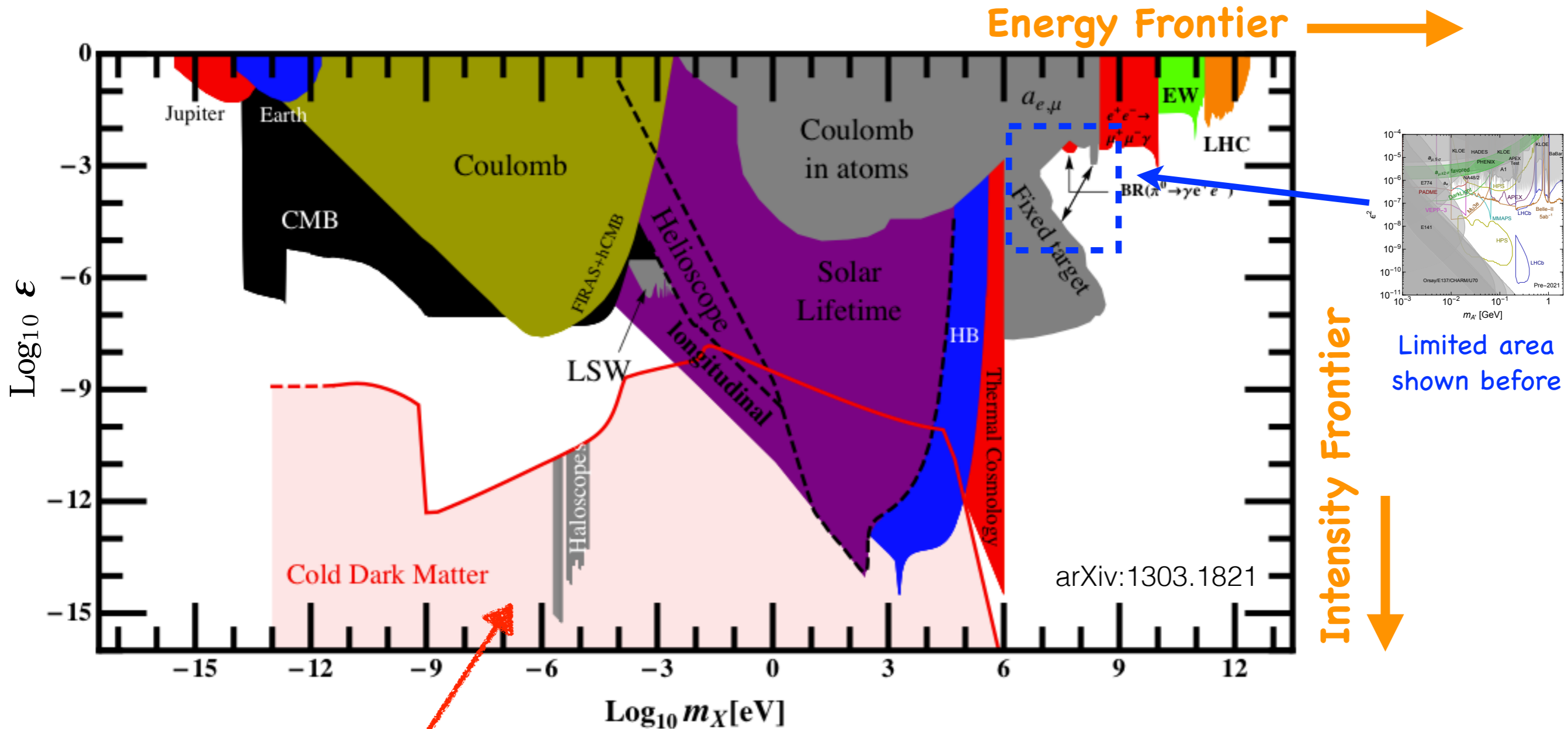

Dark photon is long-lived (compared to the Universe age, 14B years) and can be even a DM candidate. Pospelov, Ritz, Voloshin (2008)

Extremely large parameter space emerges once we accept the idea of a very small coupling.

Axion Portal

$$\frac{G_{a\gamma\gamma}}{4} a F_{\mu\nu} \tilde{F}^{\mu\nu}$$

Axion at a glance

Axion: Pseudo Nambu-Goldstone boson associated with Peccei-Quinn symmetry, a global U(1), introduced to address the strong CP problem

[Pseudo: the $U(1)_{PQ}$ is not exact, and gives a small mass to the axion]

[strong CP problem: Charge Parity symmetry breaking in the strong interaction sector is too small]

f_a (axion decay constant) = $U(1)_{PQ}$ symmetry breaking scale

$$m_a \approx \frac{\Lambda_{\text{QCD}}^2}{f_a} \approx \frac{10^{-2} \text{ GeV}^2}{f_a}, \quad G_{a\gamma\gamma} \approx \frac{\alpha_{\text{EM}}}{f_a} \mathcal{O}(1) \sim \frac{10^{-2}}{f_a}$$

Axion coupling is almost determined once its mass is given. $\frac{G_{a\gamma\gamma}}{m_a} \sim \frac{10^{-9} \text{ GeV}^{-1}}{\text{eV}}$

Axion-Like Particle (ALP): a generalized version of the axion (at the cost of original motivation from the strong CP problem). No direct relation between $G_{a\gamma\gamma}$ and mass.

Axion: practically, a very light scalar boson (with CP odd)

Current constraints on Axion and Axion-Like Particle (ALP)

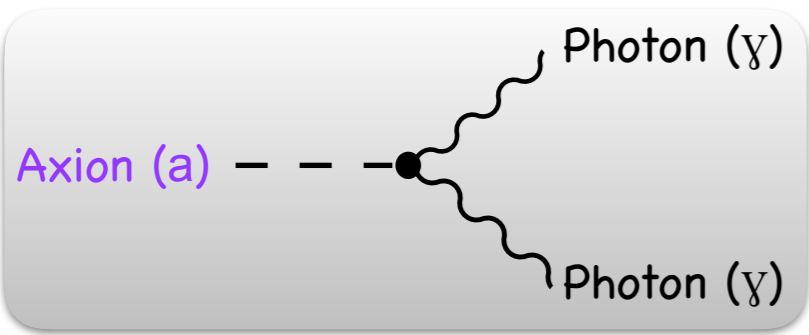

axion portal ($G_{a\gamma\gamma}$)

KAIST/IBS-CAPP experiments will test a good portion of the axion dark matter region using the axion portal.

Total Universe energy

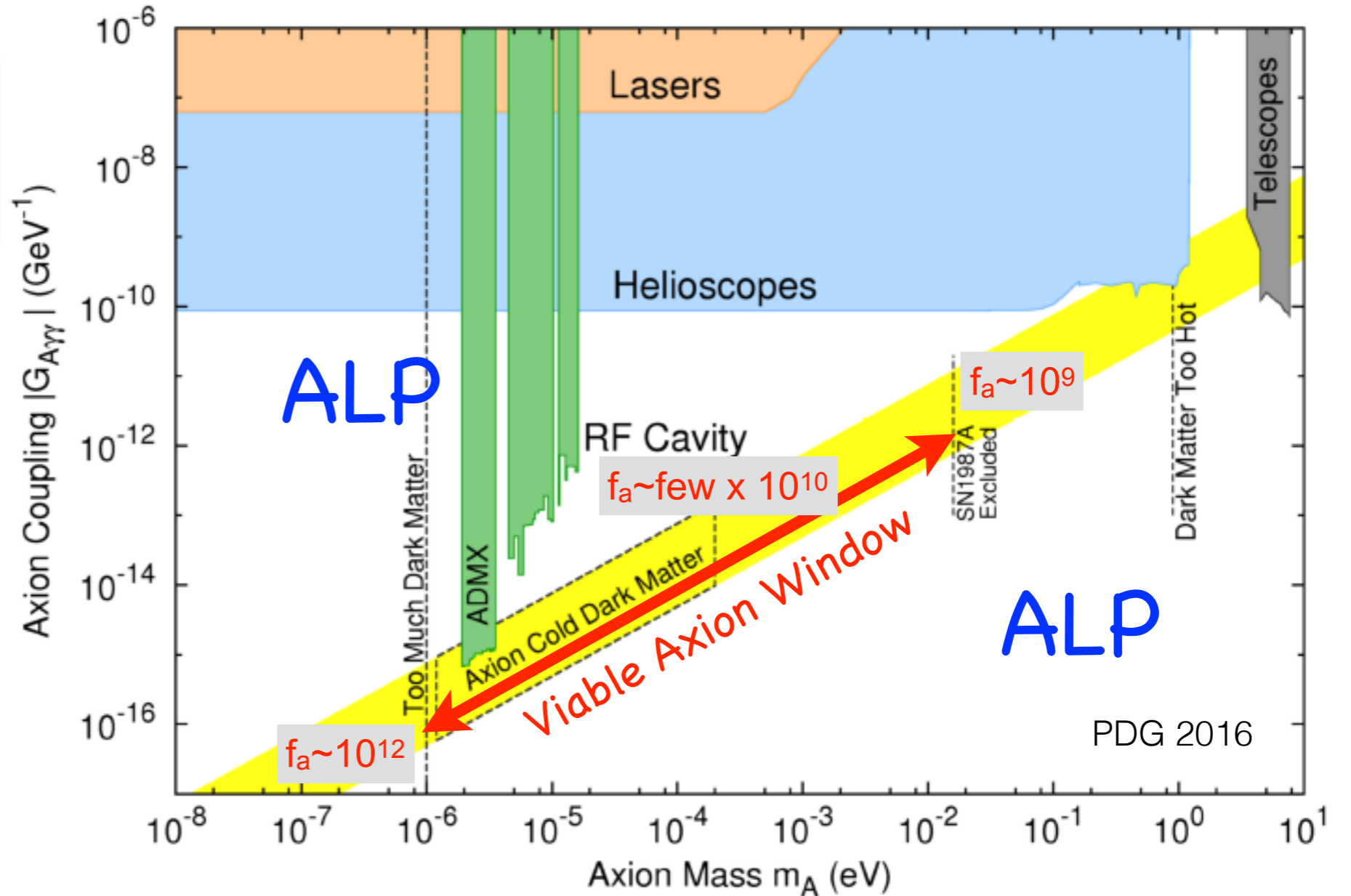
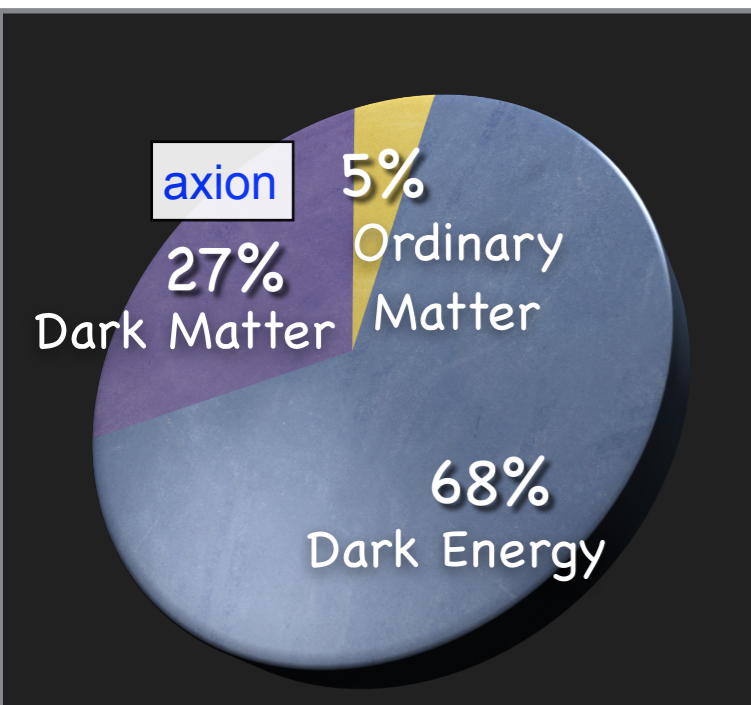

Axion suffers the relic density deficit problem for $f_a < \text{few} \times 10^{10}$ GeV : too small relic density to explain the data ($\Omega_{\text{DM}} = 22\%$)

Axion Case (Yellow band)

$$m_a \approx \frac{10^{-2} \text{ GeV}^2}{f_a}, \quad G_{a\gamma\gamma} \sim \frac{10^{-2}}{f_a}$$

f_a : $U(1)_{\text{PQ}}$ symmetry breaking scale

Dark Axion Portal

$$\frac{G_{a\gamma\gamma'}}{4} a F_{\mu\nu} \tilde{Z}'^{\mu\nu} + \frac{G_{a\gamma'\gamma'}}{4} a Z'_{\mu\nu} \tilde{Z}'^{\mu\nu}$$

“A hidden connection is stronger than an obvious one.”

- Heraclitus of Ephesus -

Dark KSVZ axion model (New axion model realizing the new portal)

[Kaneta, LEE, Yun (PRL 2017)]

To realize Dark Axion Portal, we construct **Dark KSVZ axion model**, which is a simple extension of the KSVZ axion model with the $U(1)_{\text{Dark}}$.

(KSVZ axion model: invisible axion model using exotic quarks) Kim (1979); Shifman, Vainshtein, Zakharov (1980)

Field	$SU(3)_C$	$SU(2)_L$	$U(1)_Y$	$U(1)_{\text{Dark}}$	$U(1)_{PQ}$
Q	3	2	1/6	0	0
u_R	3	1	2/3	0	0
d_R	3	1	-1/3	0	0
L	1	2	-1/2	0	0
e_R	1	1	-1	0	0
H	1	2	-1/2	0	0
ψ	3	1	Q_ψ	D_ψ	PQ_ψ
ψ^c	$\bar{3}$	1	$-Q_\psi$	$-D_\psi$	PQ_{ψ^c}
Φ_{PQ}	1	1	0	0	PQ_Φ
Φ_D	1	1	0	D_Φ	0

SM particles

Exotic heavy quarks

Extra scalars (to break PQ & Dark)

KSVZ axion model

Additional scalar for γ' mass

$$\left(\begin{array}{l} \mathcal{L} = y_\psi \Phi_{PQ} \psi \psi^c + h.c. \longrightarrow PQ_\Phi = -(PQ_\psi + PQ_{\psi^c}) \\ f_a^2 = PQ_\Phi^2 v_{PQ}^2, \quad m_a \simeq \frac{\sqrt{z}}{1+z} \frac{f_\pi m_\pi}{f_a} \quad (\text{with } z \equiv m_u/m_d \simeq 0.56) \\ G_{agg} = \frac{g_S^2}{8\pi^2} \frac{PQ_\Phi}{f_a} \\ m_{\gamma'}^2 = e'^2 D_\Phi^2 v_D^2 \end{array} \right. \quad \Phi_{PQ} \text{ is a pure gauge-singlet.}$$

Exotic colored fermions may decay into other particles through, e.g. $\Phi_D^\dagger \psi \bar{d}_R + h.c.$ for $PQ_\psi = 0$, $Q_\psi = -1/3$, $D_\psi = D_\Phi$.

It depends on the couplings of the Fermions in the triangle

In the KSVZ axion model, there are exotic quarks.

(i) Original KSVZ axion model: Exotic quarks have EM charges

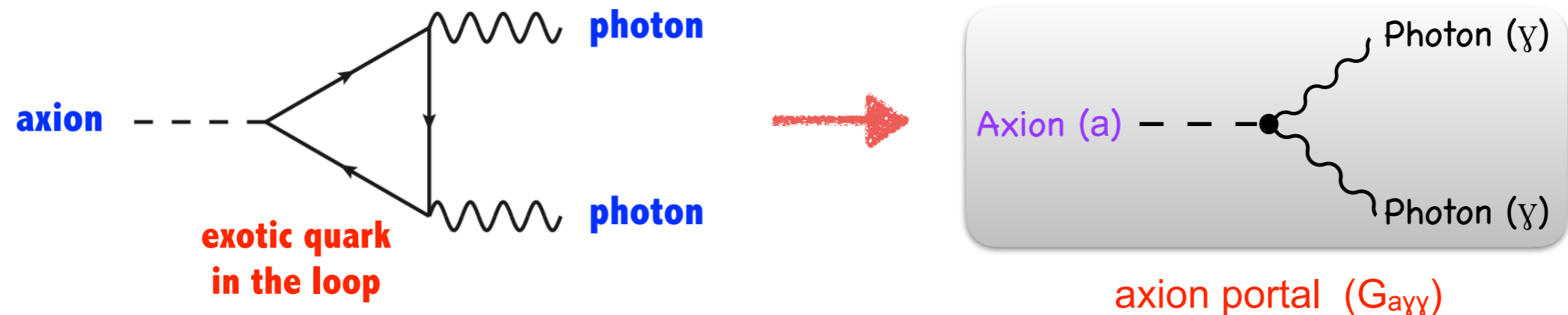

(ii) Dark KSVZ axion model: Exotic quarks have EM & Dark charges

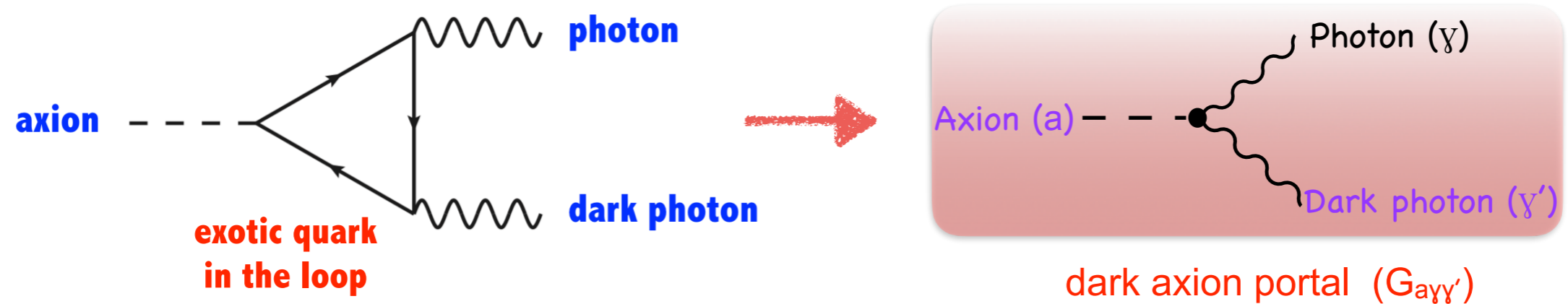

The new portal was not made just by combining two old portals [obvious connection].

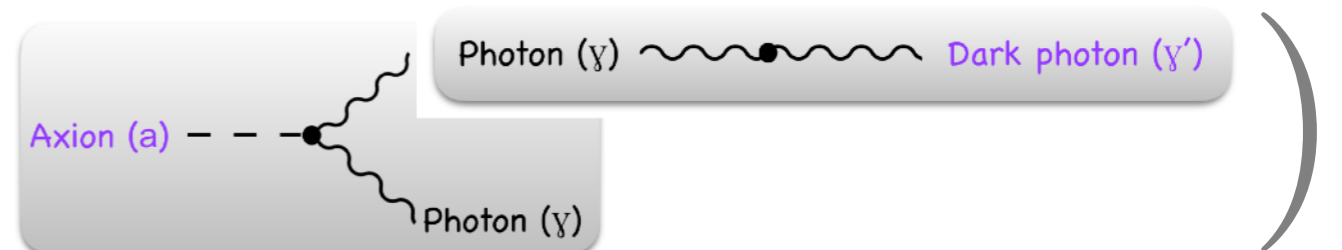

Dark Axion Portal (in Dark KSVZ axion model)

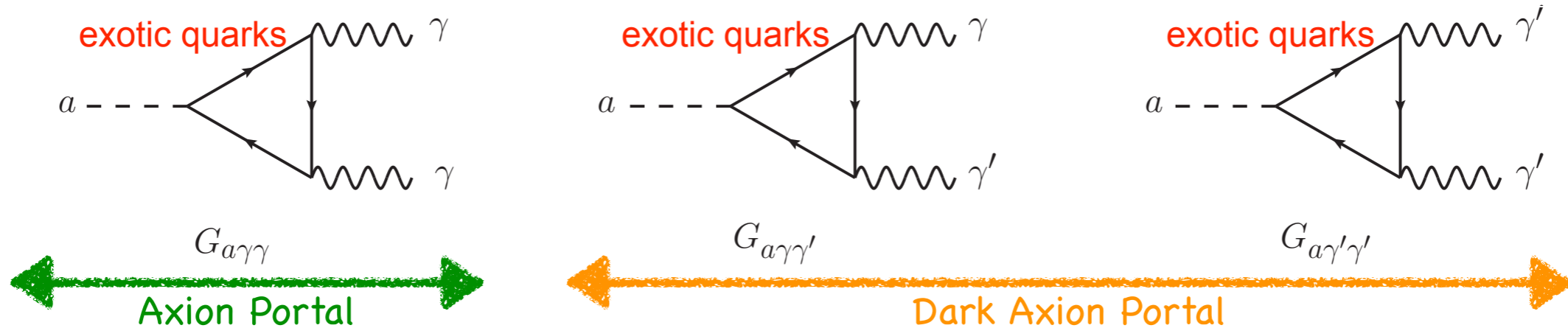

The portal interaction terms are given by

Above the QCD scale (~ 200 MeV)

$$G_{a\gamma\gamma} = \frac{e^2}{4\pi^2} \frac{PQ_\Phi}{f_a} N_C [Q_\psi^2]$$

$$G_{a\gamma\gamma'} = \frac{ee'}{4\pi^2} \frac{PQ_\Phi}{f_a} N_C [D_\psi Q_\psi] + \varepsilon G_{a\gamma\gamma}$$

$$G_{a\gamma'\gamma'} = \frac{e'^2}{4\pi^2} \frac{PQ_\Phi}{f_a} N_C [D_\psi^2] + 2\varepsilon G_{a\gamma\gamma'}$$

Q: electric charge
D: dark charge

e: EM coupling constant
e': Dark coupling constant

$N_C=3$ (color factor)

Vector portal (ε) \times Axion portal ($G_{a\gamma\gamma}$) part [obvious connection] should be **small** because $\varepsilon \ll 1$.

Dark Axion portal provides a New way to search for Dark gauge boson [using the hidden gauge coupling] even when Vector portal is closed ($\varepsilon = 0$).

Decay modes

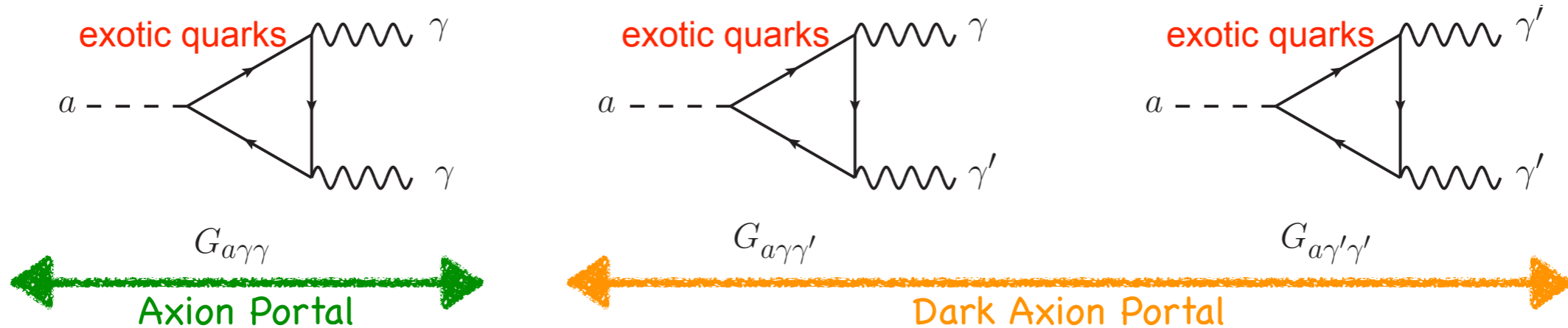

Dark photon decay

$$\Gamma(\gamma' \rightarrow e^+ e^-) = \frac{\varepsilon^2 e^2}{12\pi} m_{\gamma'} \left[1 - \frac{4m_e^2}{m_{\gamma'}^2} \right]^{1/2}$$

$$\Gamma(\gamma' \rightarrow \gamma a) = \frac{G_{a\gamma\gamma'}^2}{96\pi} m_{\gamma'}^3 \left[1 - \frac{m_a^2}{m_{\gamma'}^2} \right]^3$$

Axion decay

$$\Gamma(a \rightarrow \gamma\gamma) = \frac{G_{a\gamma\gamma}^2}{64\pi} m_a^3$$

$$\Gamma(a \rightarrow \gamma\gamma') = \frac{G_{a\gamma\gamma'}^2}{32\pi} m_a^3 \left[1 - \frac{m_{\gamma'}^2}{m_a^2} \right]^3$$

$$\Gamma(a \rightarrow \gamma'\gamma') = \frac{G_{a\gamma'\gamma'}^2}{64\pi} m_a^3 \left[1 - \frac{4m_{\gamma'}^2}{m_a^2} \right]^{3/2}$$

While typical dark photon search looks for dileptons,
its dominant decay could be into a photon + axion.

(Γ = partial decay width)

Implications of the Dark Axion Portal (Cosmic Frontier)

(i) New dark photon production mechanism

[Kaneta, LEE, Yun (2017)]

Very light dark photon
: DM candidate

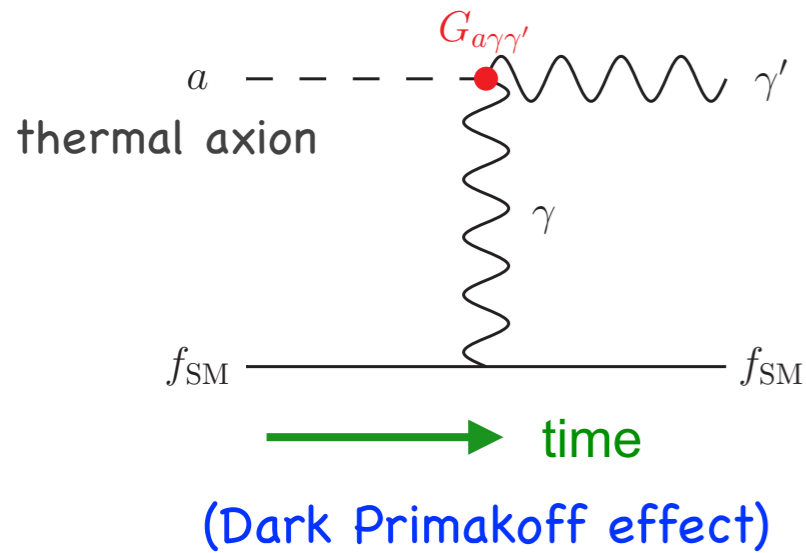

PQ symmetry breaking scale (axion physics)

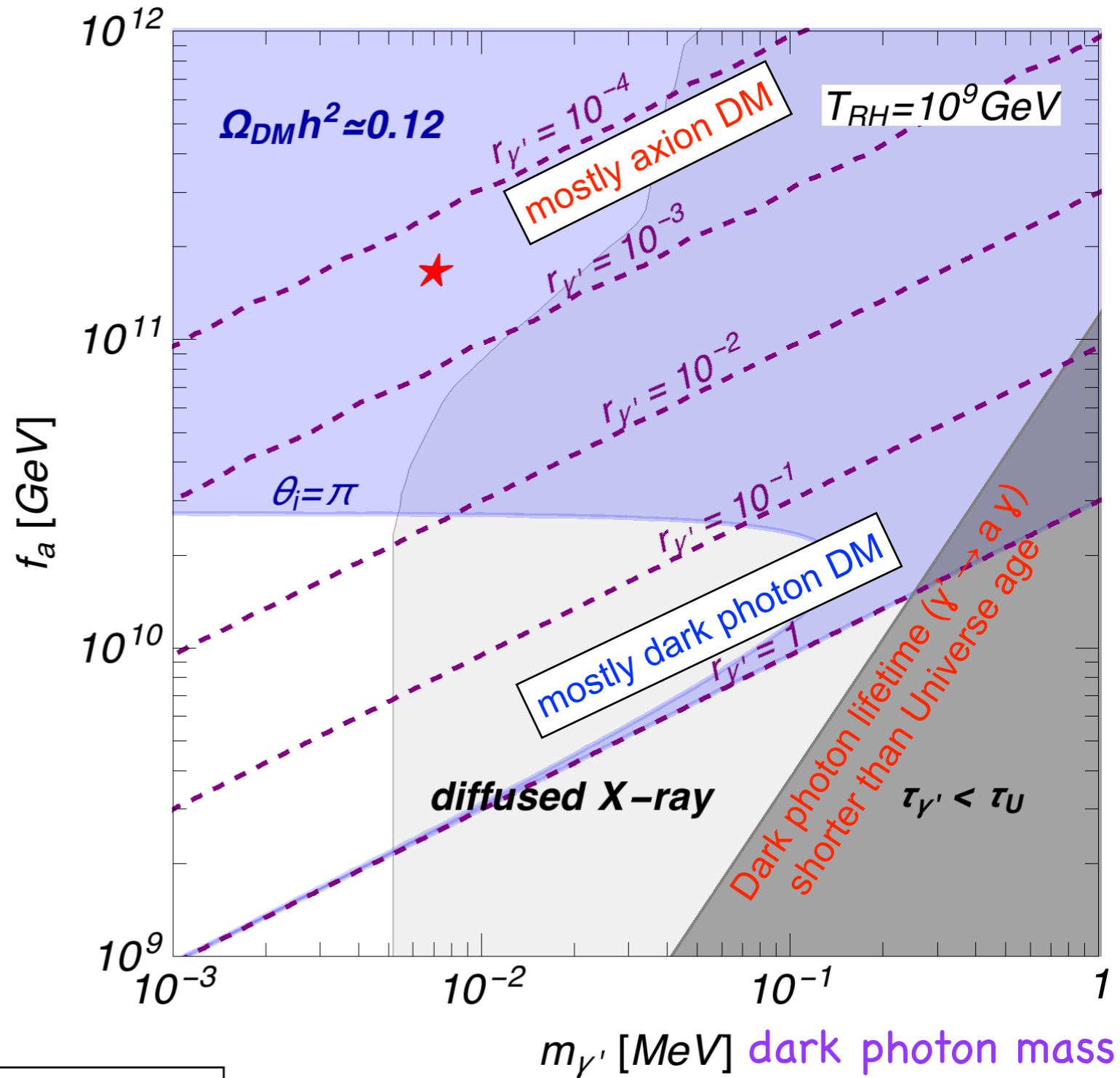

Dark photon decays slowly into axion + photon. ($\gamma' \rightarrow a \gamma$)

Purple region gives the correct total DM relic density ($\Omega_{DM} = 27\%$).

for $e' = 0.1$, $D_\psi = 0.1$, $Q_\psi = -1/3$

$r_{\gamma'}$ = fraction of dark photon (γ') in total DM

(ii) Explanation of the 3.5 keV X-ray puzzle

[Kaneta, LEE, Yun (2017)]

axion mass $\approx 10^{-4}$ eV
 γ' mass = 7 keV
 γ' lifetime = $r_{\gamma'} \times 10^{28}$ sec

3.5 keV X-ray excess explained

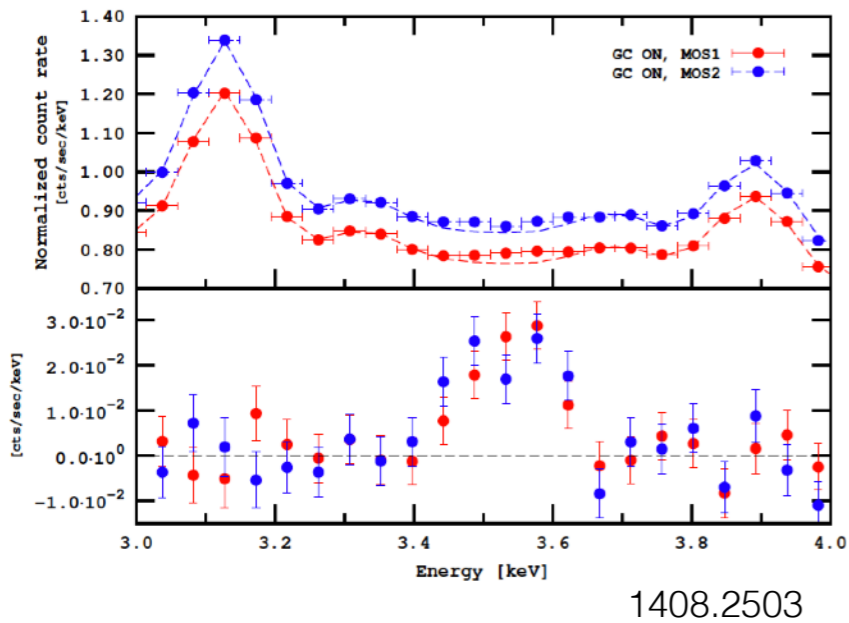

PQ symmetry breaking scale (axion physics)

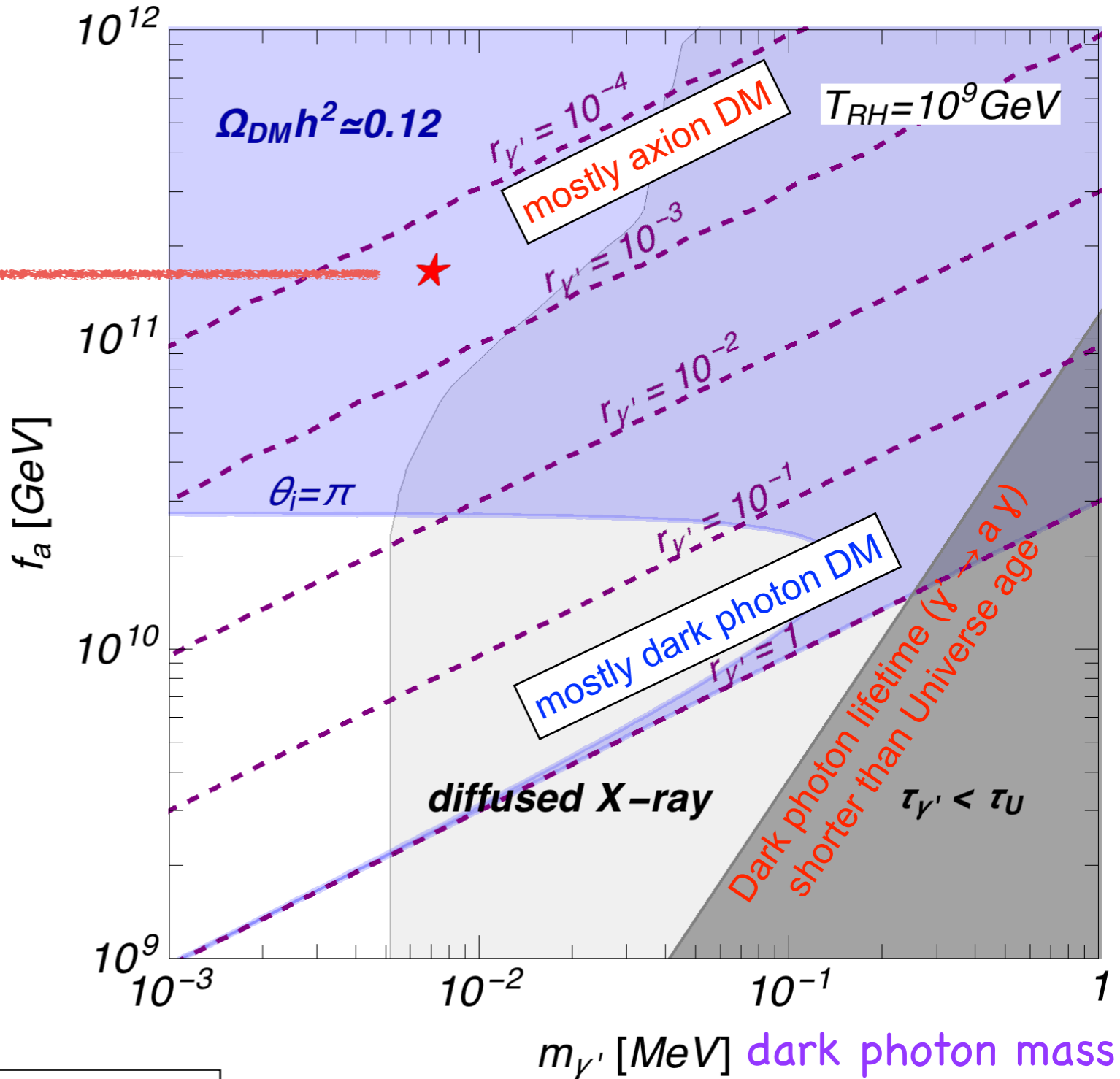

Dark photon decays slowly into axion + photon. ($\gamma' \rightarrow a \gamma$)

Interestingly, (from 2014) there is a reported 3.5 keV X-ray excess from the galaxies (roughly $3\sim 4\sigma$ C.L. depending on the source). Currently, under scrutiny by many studies.

$r_{\gamma'}$ = fraction of dark photon (γ') in total DM

Implications of the Dark Axion Portal (Intensity Frontier)

Visible/Invisible decay of Dark photon

New categories of Dark force search (in terms of the dominant decay modes) :

(i) “Dilepton Resonance” search

Visible dark photon mode

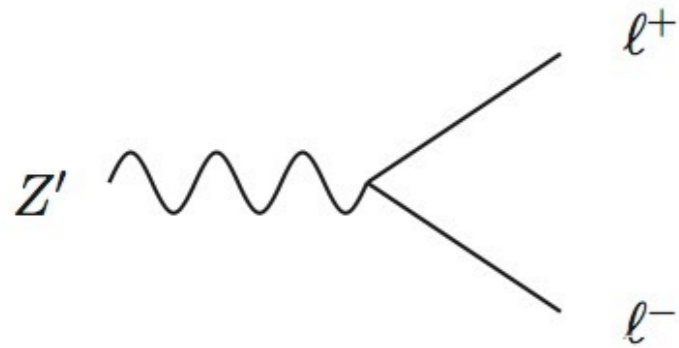

$$\Gamma(\gamma' \rightarrow e^+ e^-) = \frac{\varepsilon^2 e^2}{12\pi} m_{\gamma'} \left(1 - \frac{4m_\chi^2}{m_{\gamma'}^2}\right)^{1/2}$$

(ii) “Missing Energy” search

Invisible dark photon mode

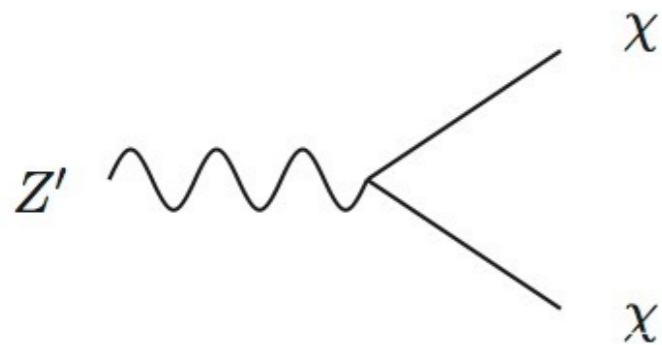

$$\Gamma(\gamma' \rightarrow \chi \bar{\chi}) = \frac{e'^2 D_\chi^2}{12\pi} m_{\gamma'} \left(1 - \frac{4m_\chi^2}{m_{\gamma'}^2}\right)^{1/2}$$

(iii) “Photon” search

“New” visible dark photon mode

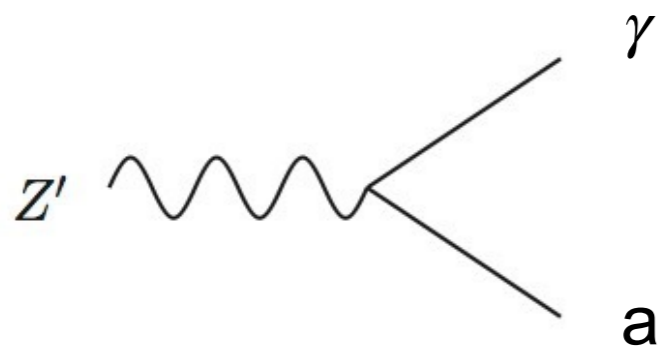

$$\Gamma(\gamma' \rightarrow \gamma a) = \frac{G_{a\gamma\gamma'}^2}{96\pi} m_{\gamma'}^3 \left(1 - \frac{m_a^2}{m_{\gamma'}^2}\right)^3$$

Photon searches for dark photon

[deNiverville, LEE, Seo (2018); deNiverville, LEE (2019)]

$G_{a\gamma\gamma'}$ only (model-independent way): We take axion as a very light particle carrying a missing energy, and neglect the effect of $G_{a\gamma\gamma}$ vertex. (Absence of exotic quarks signal impose additional constraints.)

dark axion portal ($G_{a\gamma\gamma'}$)

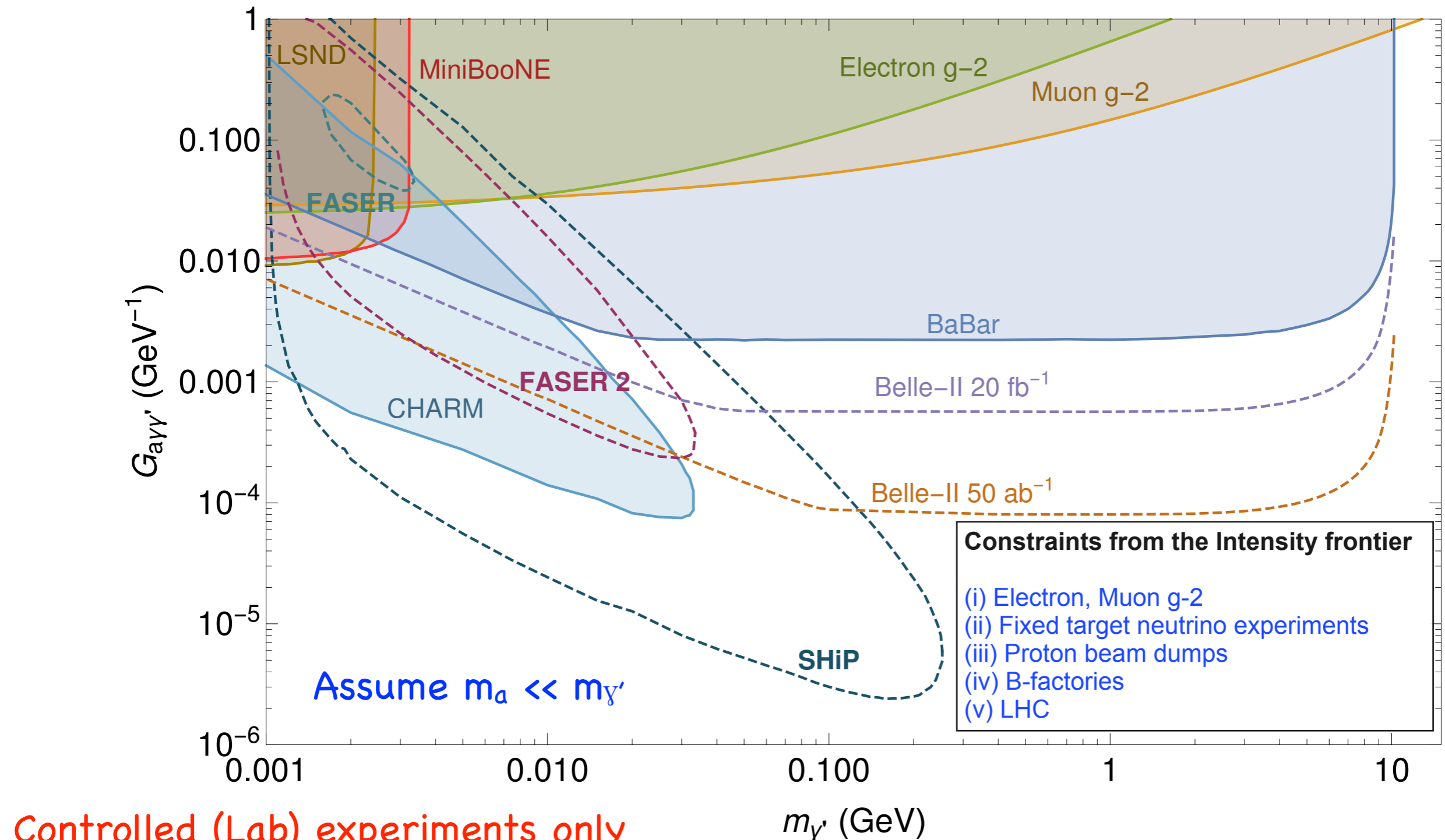

Controlled (Lab) experiments only

B-factories (BaBar, Belle II)

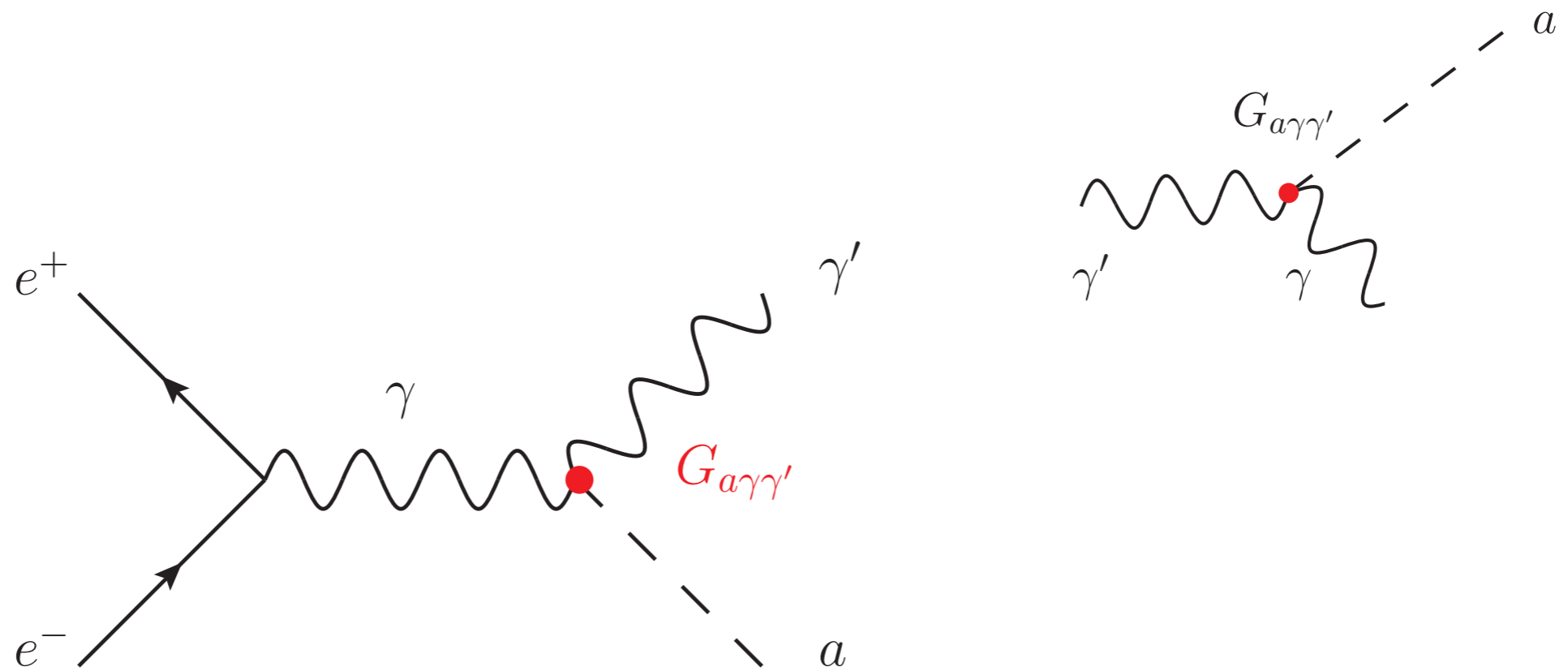

B-factories are asymmetric e^+e^- colliders of $E_{\text{CM}} \approx 10$ GeV.

e^+e^- can annihilate into a dark photon + axion, and the dark photon can decay into a photon + axion ($e^+e^- \rightarrow \gamma' a \rightarrow \gamma a a$). It is a **mono-photon** search.

Proton beam dumps (CHARM, SHiP future)

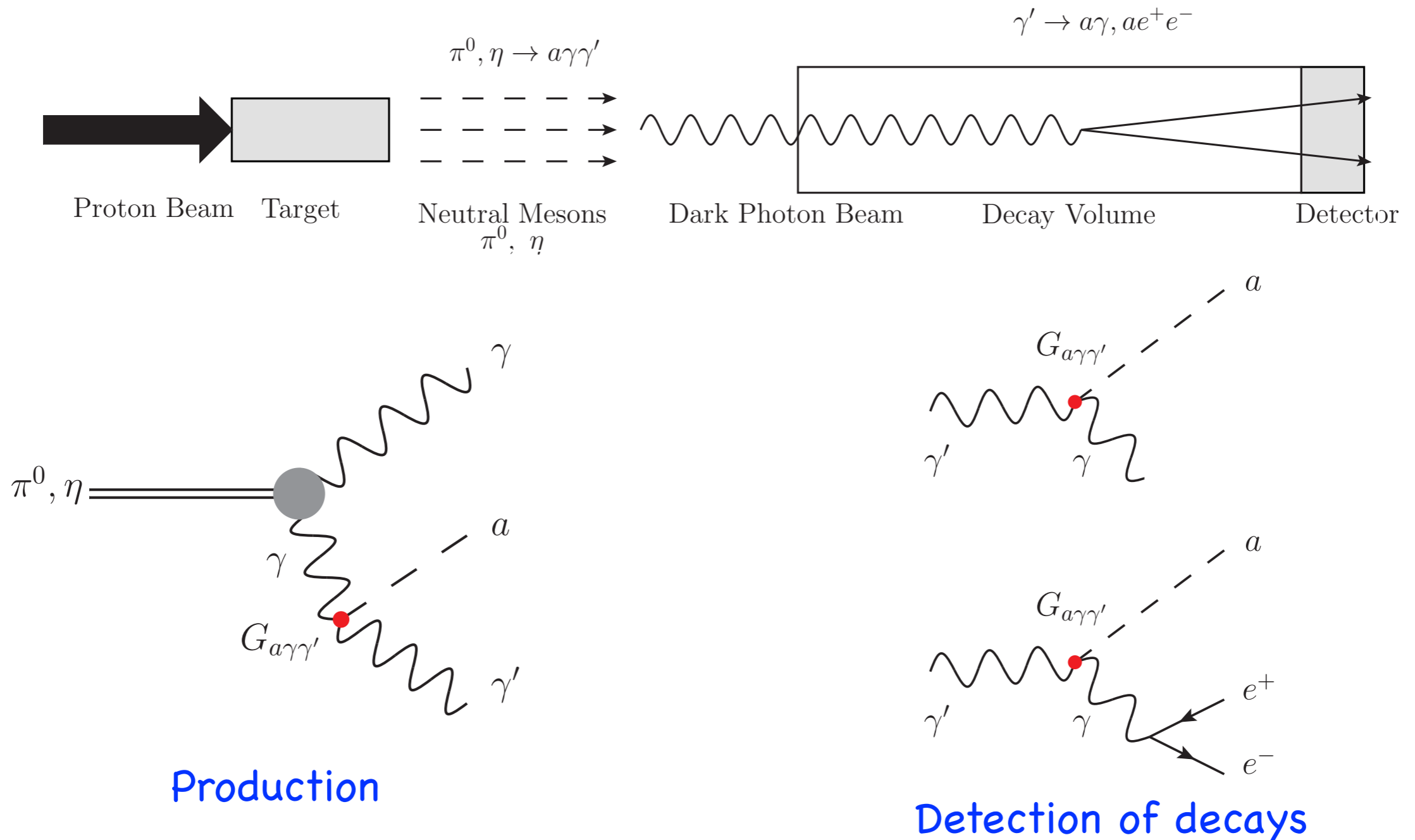

π (η) mesons decay into a photon + axion + dark photon.

Dark photons can **decay** into the **mono-photon** + axion (CHARM) or **2 charged tracks** + axion (SHiP).

Neutrino fixed target experiments (LSND, MiniBooNE)

(originally for $\pi^\pm, K^\pm \rightarrow \nu_\mu \mu^\pm$)

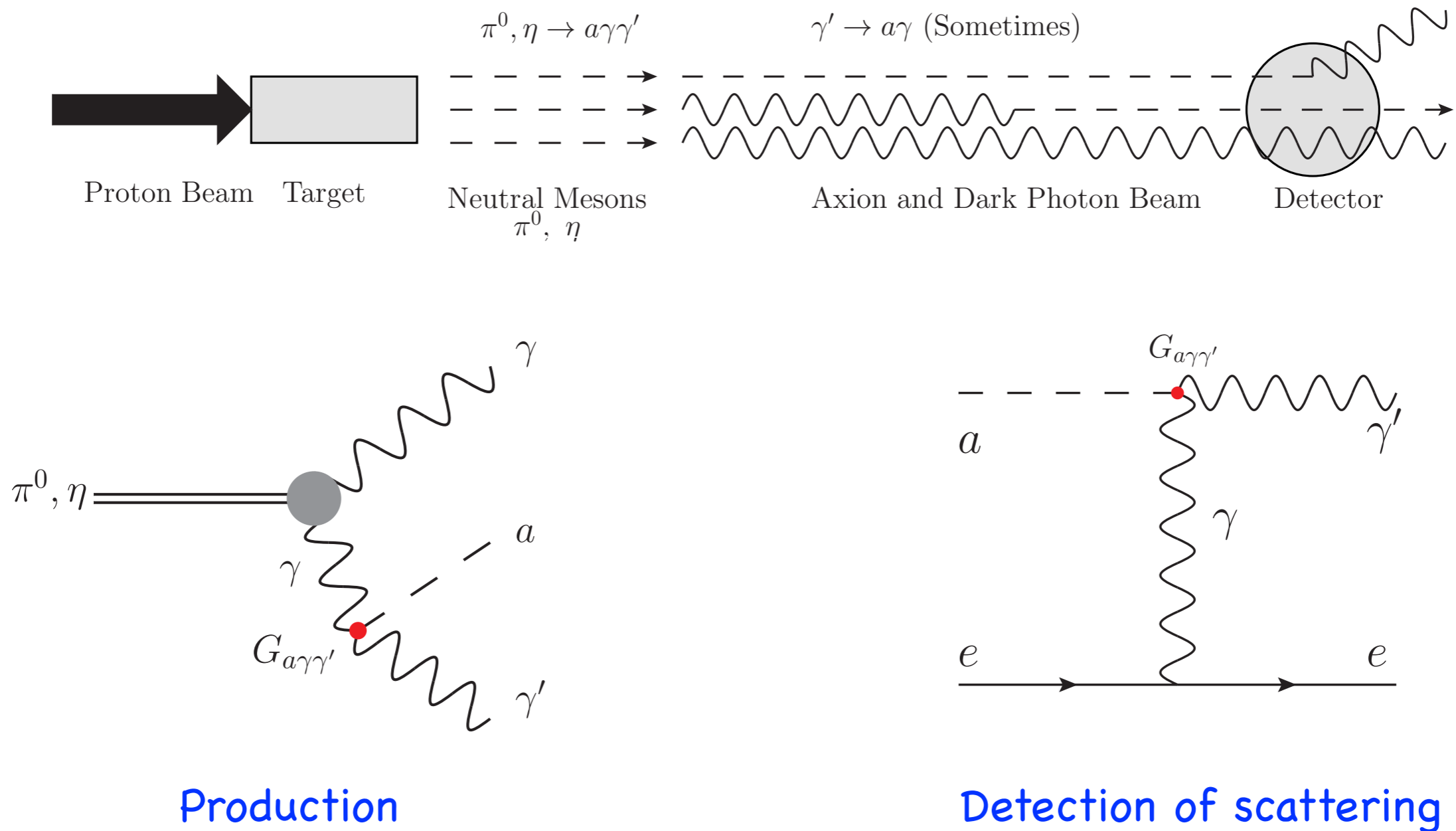

π (η) mesons decay into a photon + axion + dark photon.

Axion can **scatter** with the **electrons** in the detector (mineral oil, etc).

Signals are similar to the neutral current elastic (NCE) scattering of the neutrinos.

Photon searches for dark photon

[deNiverville, LEE, Seo (2018); deNiverville, LEE (2019)]

$G_{a\gamma\gamma'}$ only (model-independent way): We take axion as a very light particle carrying a missing energy, and neglect the effect of $G_{a\gamma\gamma}$ vertex. (Absence of exotic quarks signal impose additional constraints.)

dark axion portal ($G_{a\gamma\gamma'}$)

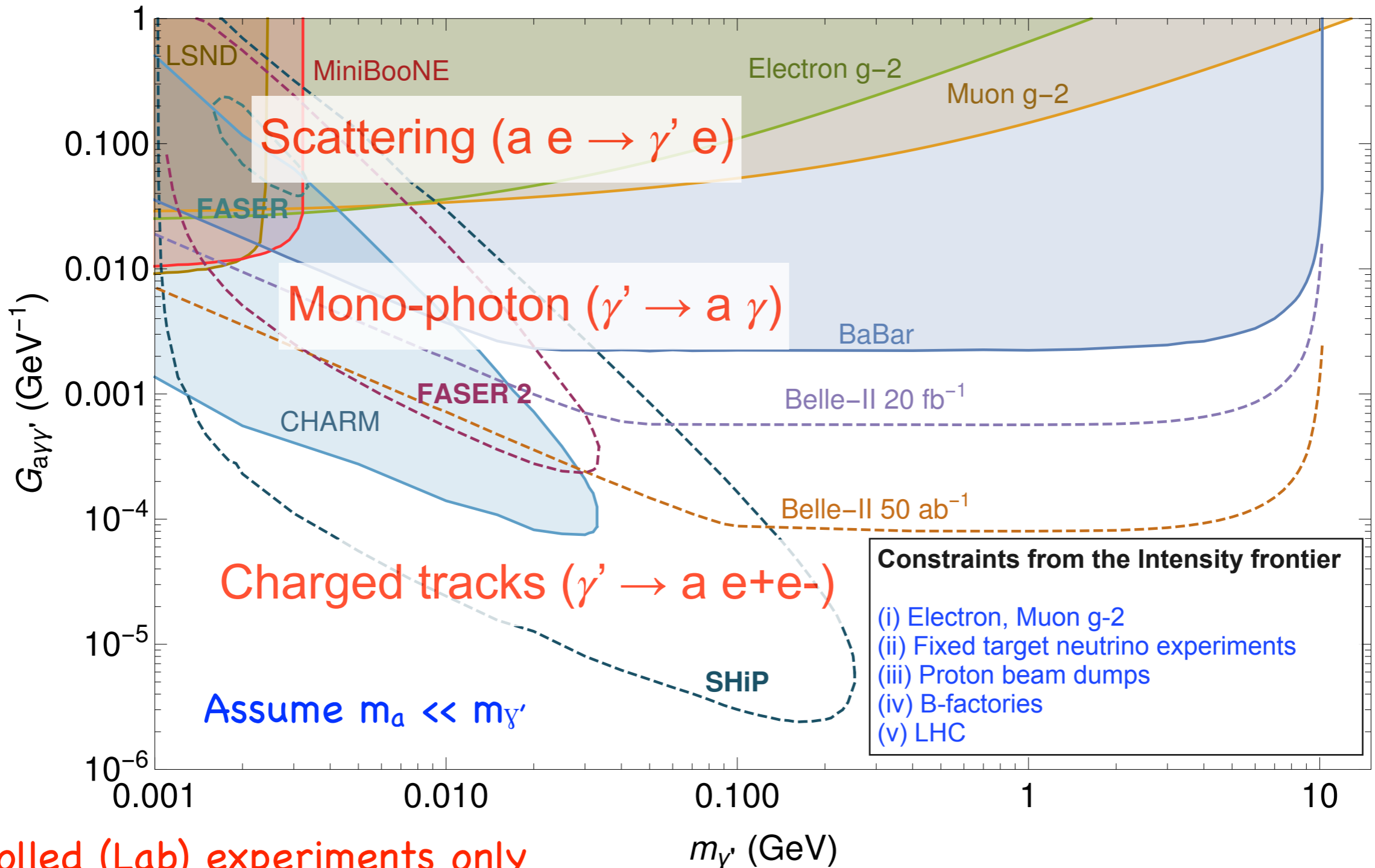

New possibility: Low-energy e-beam dump with photon signal

[deNiverville, LEE (2019)]

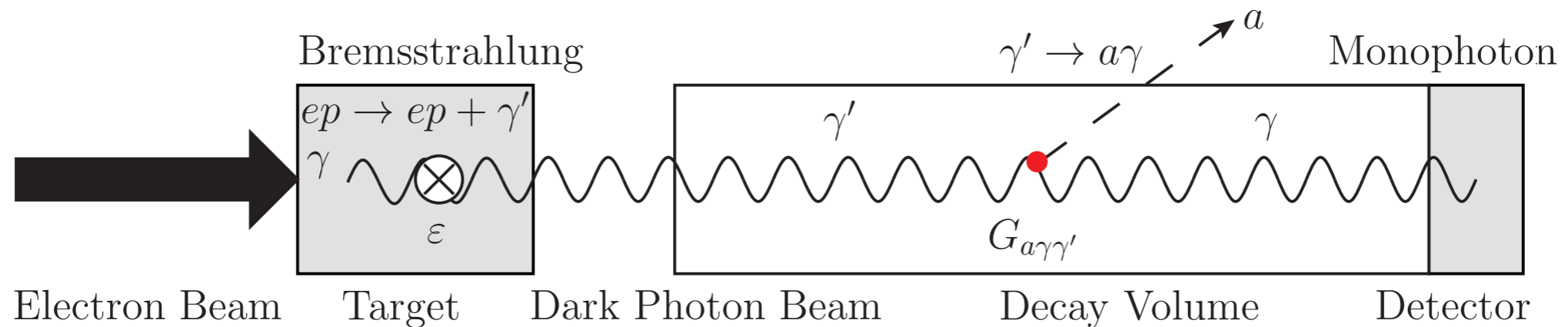

Major production of dark photon through the **vector portal (Bremsstrahlung)** at the **affordable e-beam facilities**, and the major decay to the **mono-photon** through the **dark axion portal ($\gamma' \rightarrow \gamma + a$)**.

The dominant $\gamma' \rightarrow \gamma + a$ can suppress the severe kinetic mixing constraints.

(Detailed design study is called for.)

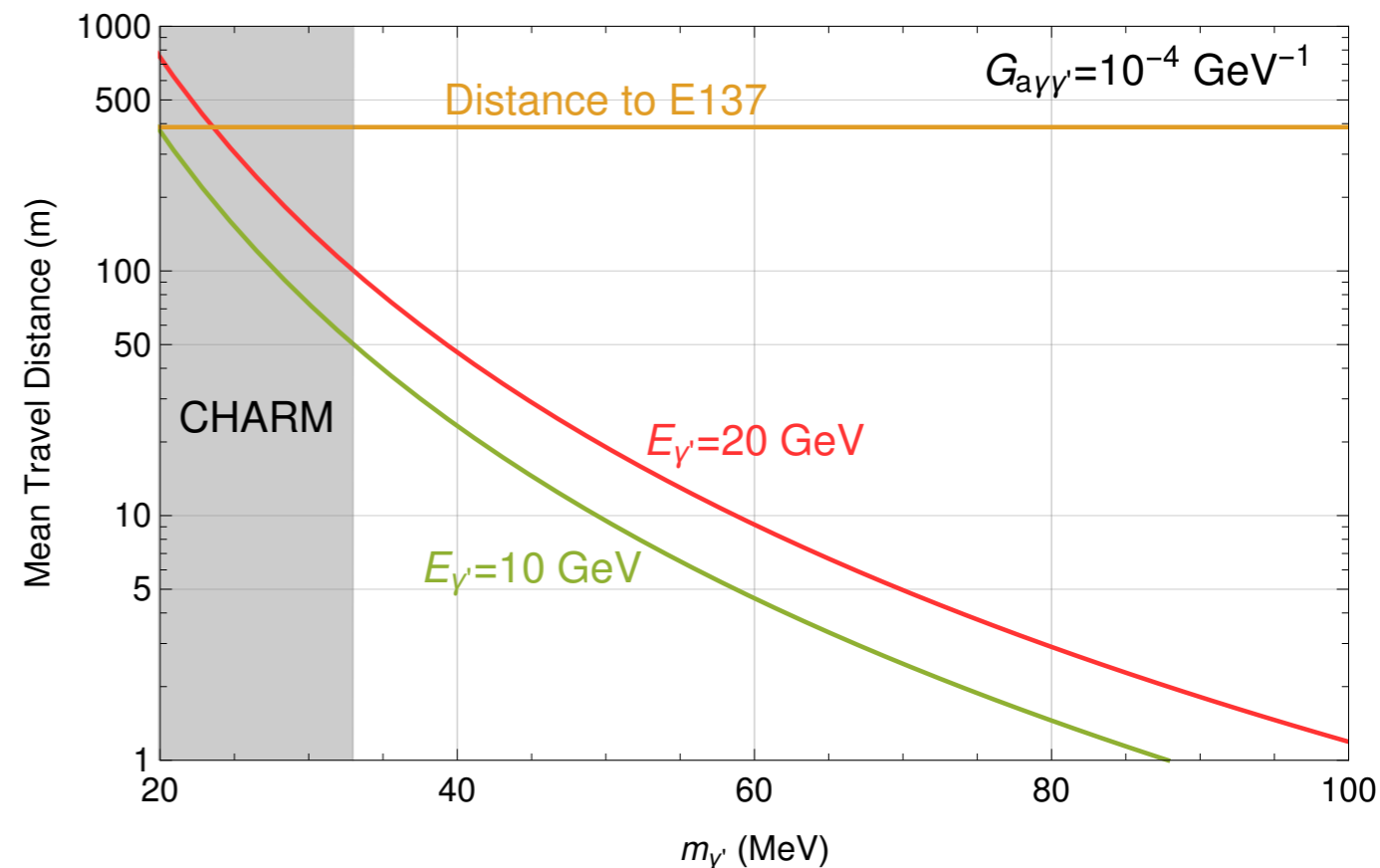

Dark Axion Portal at the LHC (Energy Frontier)?

There are models which have a dark photon (or its variant) in the final states.

Searched for as “Lepton-Jets” (highly collimated leptons. $\gamma' \longrightarrow \ell^+ \ell^-$) using vector portal.

(Currently, searching for dark photons at the LHC = searching for lepton-jets.)

(ex) rare Higgs decay

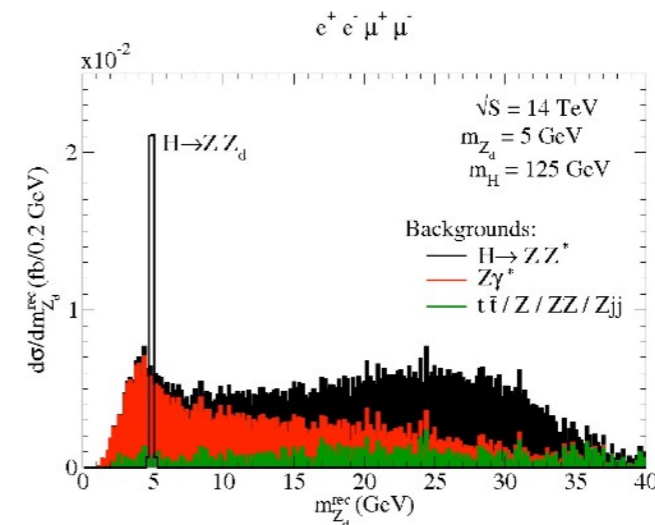
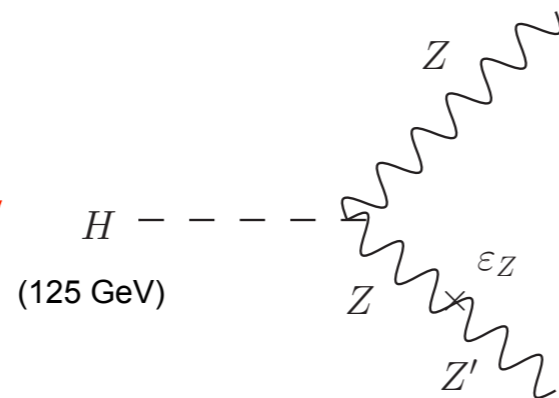

[Davoudiasl, LEE, Lewis, Marciano (2013)]

Depending on the model, the decay mode to dark photon can even dominate.

(ex) Top-partner \longrightarrow Top + γ' as the dominant decay mode (followed by $\gamma' \longrightarrow \ell^+ \ell^-$).

[Kim, Lane, LEE, Lewis, Sullivan (2019)]

In the presence of the dark axion portal ($G_{a\gamma\gamma'}$), one might need to search for “photons” ($\gamma' \longrightarrow \gamma a$), which can dominate the decay branching ratio.

Concluding Remarks

	<p>mass → $\approx 2.3 \text{ MeV}/c^2$</p> <p>charge → $2/3$</p> <p>spin → $1/2$</p> <p>u</p> <p>up</p>	<p>mass → $\approx 1.275 \text{ GeV}/c^2$</p> <p>charge → $2/3$</p> <p>spin → $1/2$</p> <p>c</p> <p>charm</p>	<p>mass → $\approx 173.07 \text{ GeV}/c^2$</p> <p>charge → $2/3$</p> <p>spin → $1/2$</p> <p>t</p> <p>top</p>	<p>mass → 0</p> <p>charge → 0</p> <p>spin → 1</p> <p>g</p> <p>gluon</p>	<p>mass → $\approx 126 \text{ GeV}/c^2$</p> <p>charge → 0</p> <p>spin → 0</p> <p>H</p> <p>Higgs boson</p>
QUARKS	<p>mass → $\approx 4.8 \text{ MeV}/c^2$</p> <p>charge → $-1/3$</p> <p>spin → $1/2$</p> <p>d</p> <p>down</p>	<p>mass → $\approx 95 \text{ MeV}/c^2$</p> <p>charge → $-1/3$</p> <p>spin → $1/2$</p> <p>s</p> <p>strange</p>	<p>mass → $\approx 4.18 \text{ GeV}/c^2$</p> <p>charge → $-1/3$</p> <p>spin → $1/2$</p> <p>b</p> <p>bottom</p>	<p>mass → 0</p> <p>charge → 0</p> <p>spin → 1</p> <p>γ</p> <p>photon</p>	
	<p>mass → $0.511 \text{ MeV}/c^2$</p> <p>charge → -1</p> <p>spin → $1/2$</p> <p>e</p> <p>electron</p>	<p>mass → $105.7 \text{ MeV}/c^2$</p> <p>charge → -1</p> <p>spin → $1/2$</p> <p>μ</p> <p>muon</p>	<p>mass → $1.777 \text{ GeV}/c^2$</p> <p>charge → -1</p> <p>spin → $1/2$</p> <p>τ</p> <p>tau</p>	<p>mass → $91.2 \text{ GeV}/c^2$</p> <p>charge → 0</p> <p>spin → 1</p> <p>Z</p> <p>Z boson</p>	GAUGE BOSONS
LEPTONS	<p>mass → $< 2.2 \text{ eV}/c^2$</p> <p>charge → 0</p> <p>spin → $1/2$</p> <p>ν_e</p> <p>electron neutrino</p>	<p>mass → $< 0.17 \text{ MeV}/c^2$</p> <p>charge → 0</p> <p>spin → $1/2$</p> <p>ν_μ</p> <p>muon neutrino</p>	<p>mass → $< 15.5 \text{ MeV}/c^2$</p> <p>charge → 0</p> <p>spin → $1/2$</p> <p>ν_τ</p> <p>tau neutrino</p>	<p>mass → $80.4 \text{ GeV}/c^2$</p> <p>charge → ± 1</p> <p>spin → 1</p> <p>W</p> <p>W boson</p>	

Standard Model

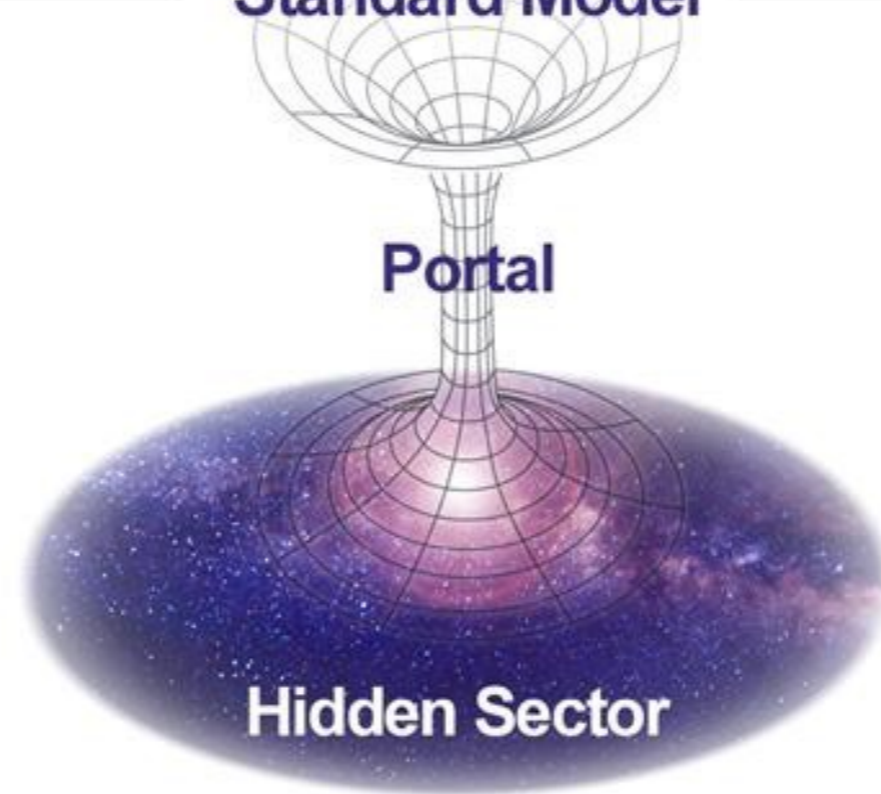

Dark sector could be investigated through portals.

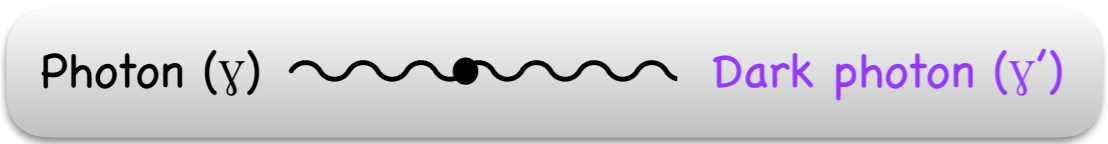

vector portal (ϵ)

(ex) Holdom (1986): 1100+ citations (used in actual searches)

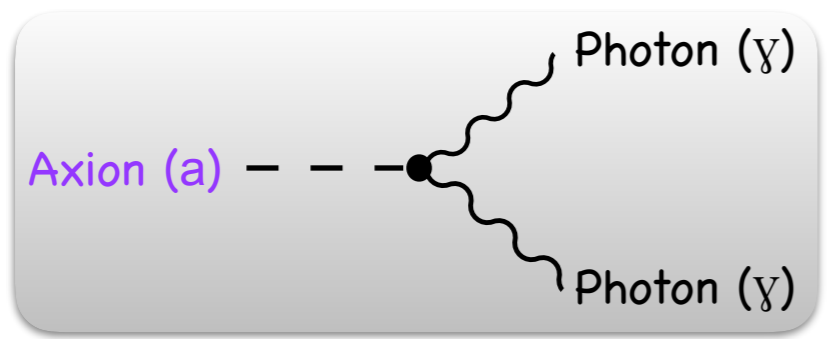
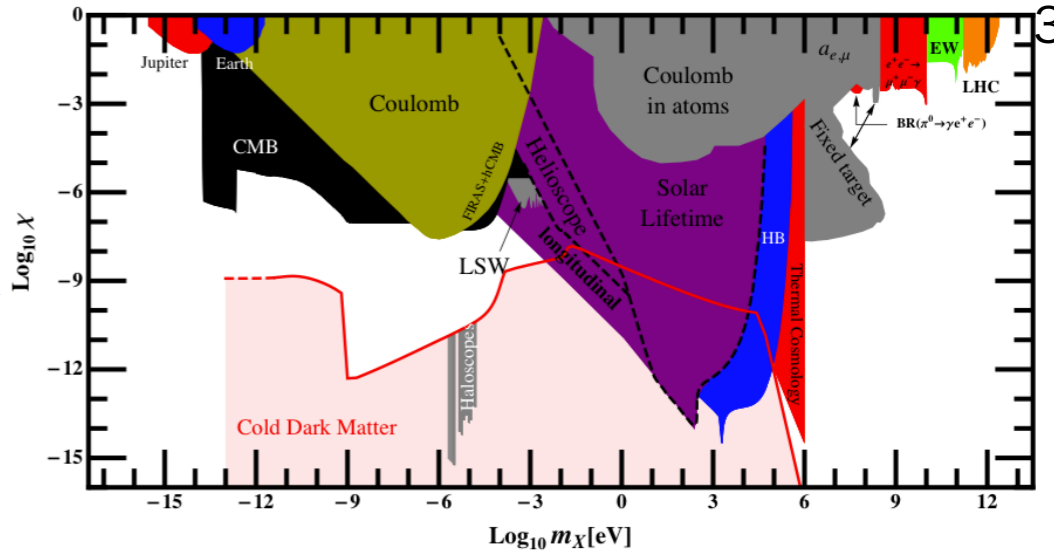

axion portal ($G_{A\gamma\gamma}$)

(ex) Sikivie (1983): 1000+ citations (used in actual searches)

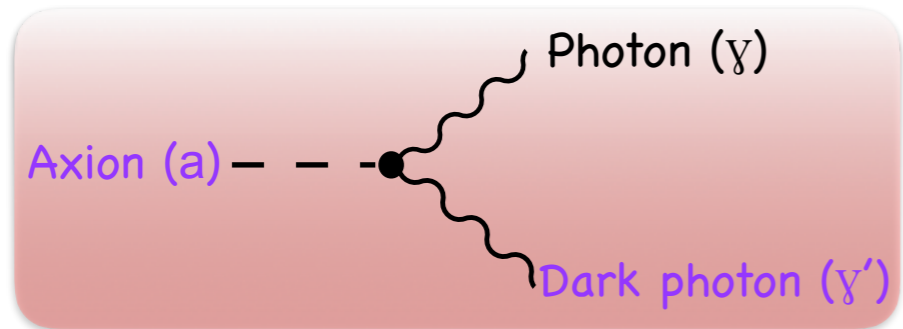
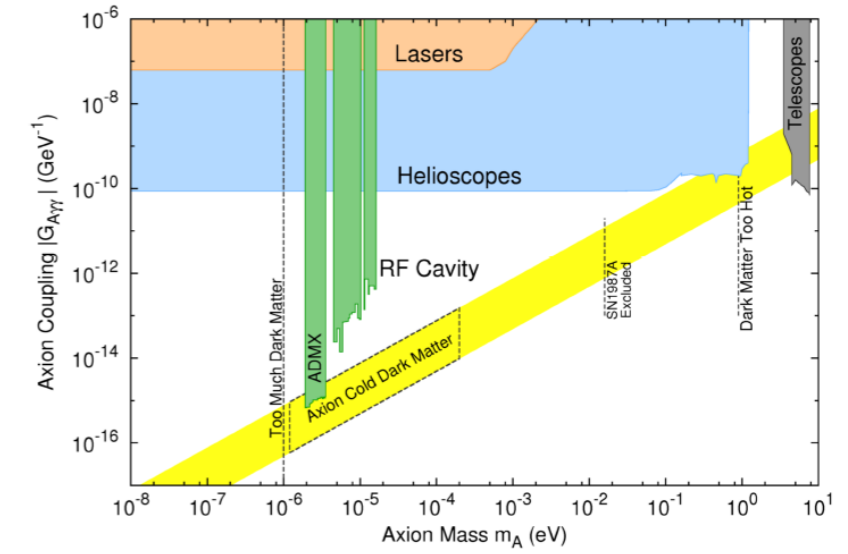

dark axion portal ($G_{A\gamma\gamma'}$)
Kaneta, LEE, Yun (2017)

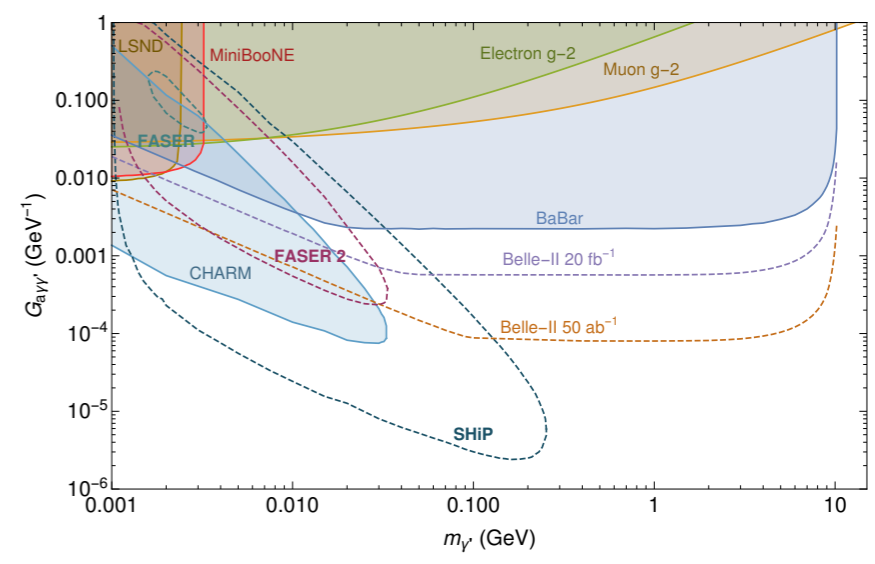

When a new portal is introduced,
there are a lot of physics we can explore with it

We live in a Dark World

Total Universe Energy

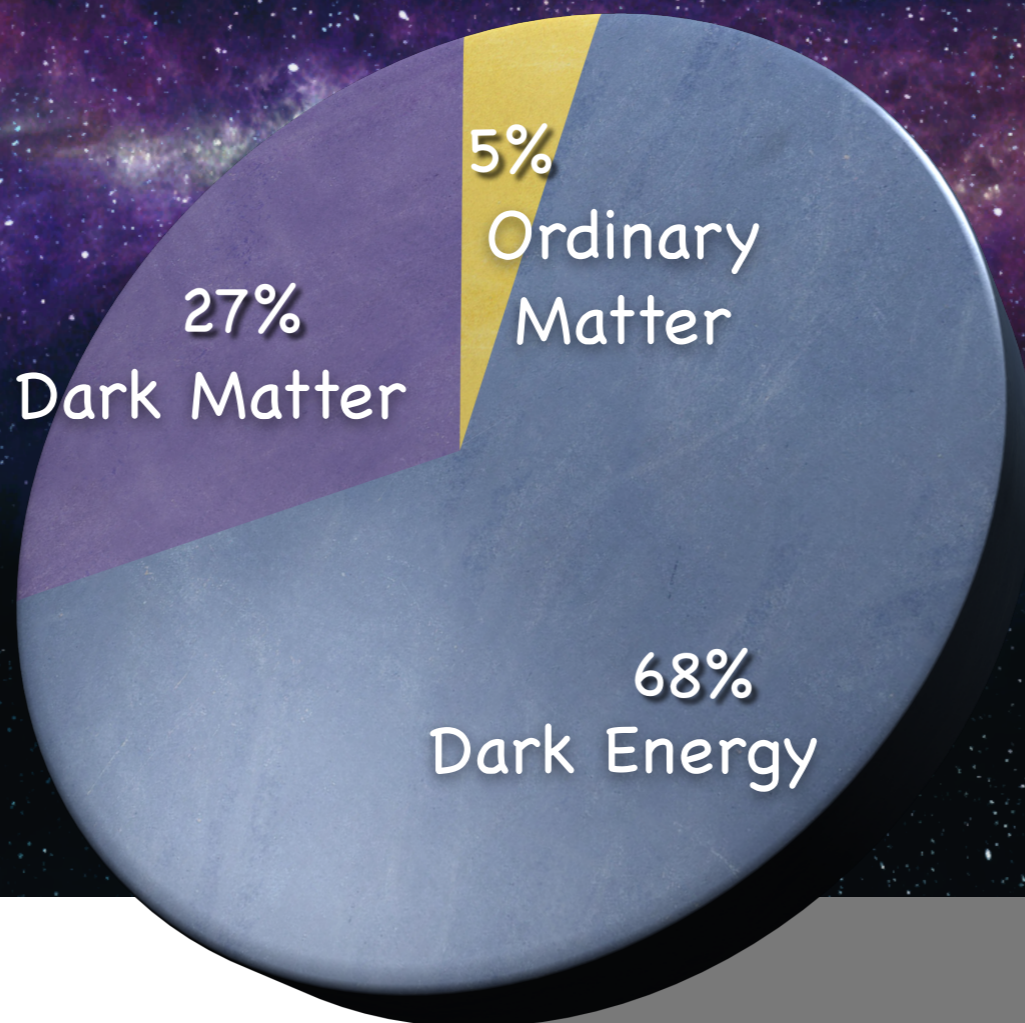

$$\nabla \cdot \vec{E} = \rho$$

$$\nabla \times \vec{E} = -\frac{\partial \vec{B}}{\partial t}$$

$$\nabla \cdot \vec{B} = 0$$

$$\nabla \times \vec{B} = \vec{J} + \frac{\partial \vec{E}}{\partial t}$$

Bright sector

Dark sector

We live in a Dark World

Total Universe Energy

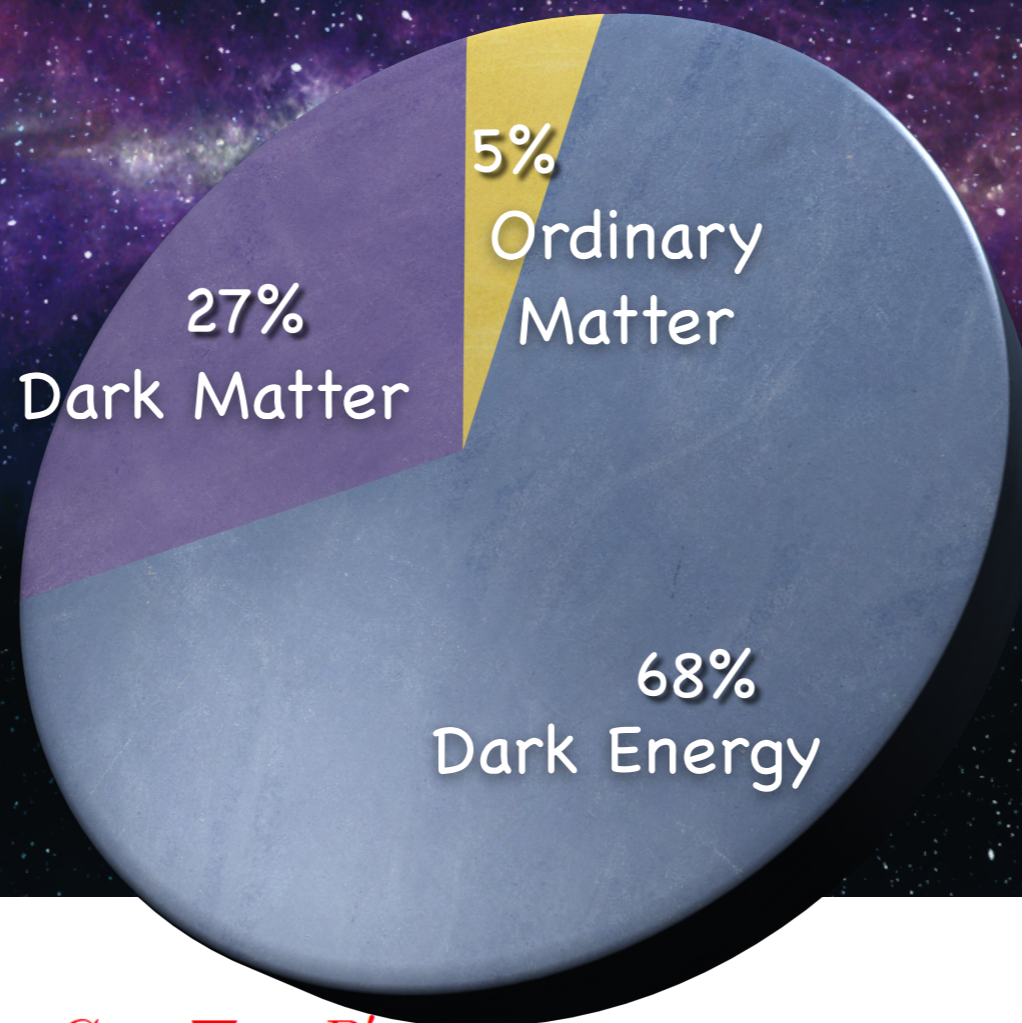

$$\nabla \cdot \vec{E} = \rho + G_{\alpha\gamma\gamma} \nabla a \cdot \vec{B} + G_{\alpha\gamma\gamma'} \nabla a \cdot \vec{B}'$$

$$\nabla \times \vec{E} = -\frac{\partial \vec{B}}{\partial t}$$

$$\nabla \cdot \vec{B} = 0$$

$$\nabla \times \vec{B} = \vec{J} + \frac{\partial \vec{E}}{\partial t} - G_{\alpha\gamma\gamma} \left(\frac{\partial a}{\partial t} \vec{B} + \nabla a \times \vec{E} \right) - G_{\alpha\gamma\gamma'} \left(\frac{\partial a}{\partial t} \vec{B}' + \nabla a \times \vec{E}' \right)$$

The future of the dark sector is bright.

- Thank you -