

Detector Simulation Geometry

Witek Pokorski
Alberto Ribon
CERN

10-11.02.2020



Challenge

- how to implement (efficiently) this in your computer program?
 - you need 'bricks'
 - 'solids', 'shapes'
 - you need to position them
 - you want to 'reuse' as much as possible the same 'templates'

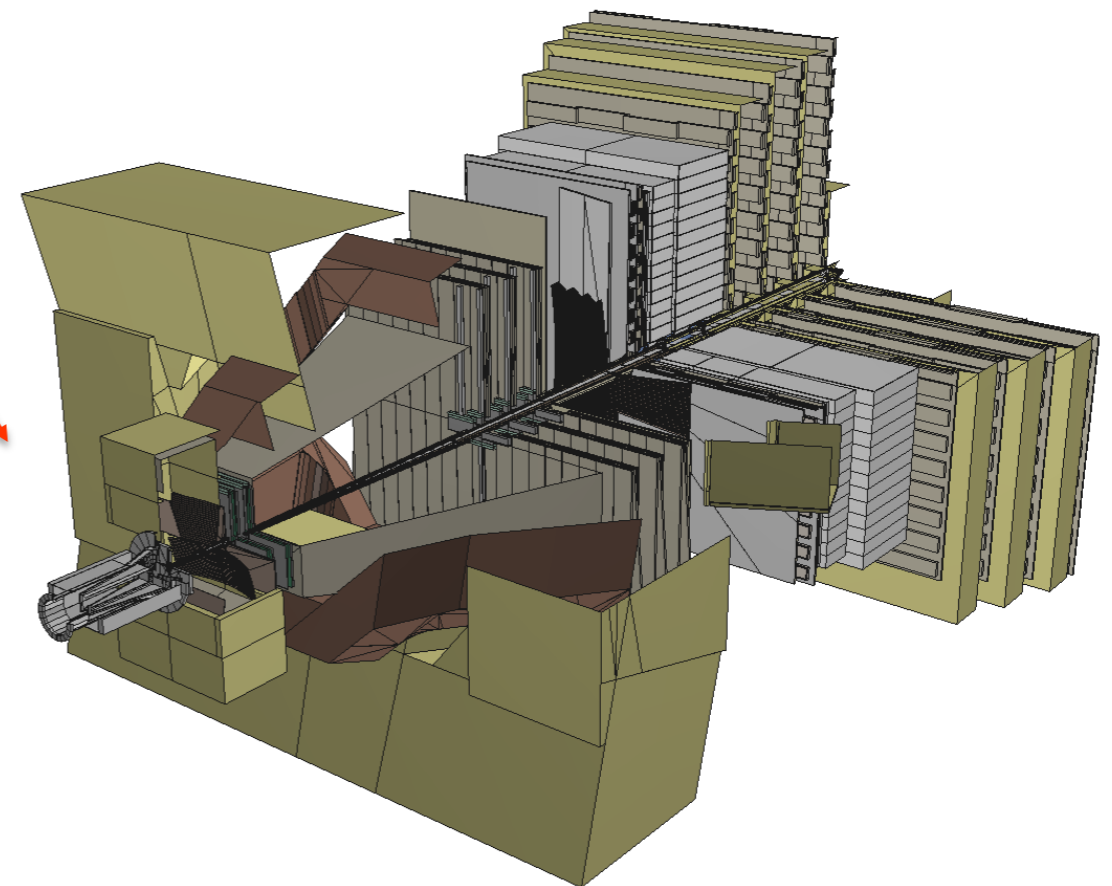
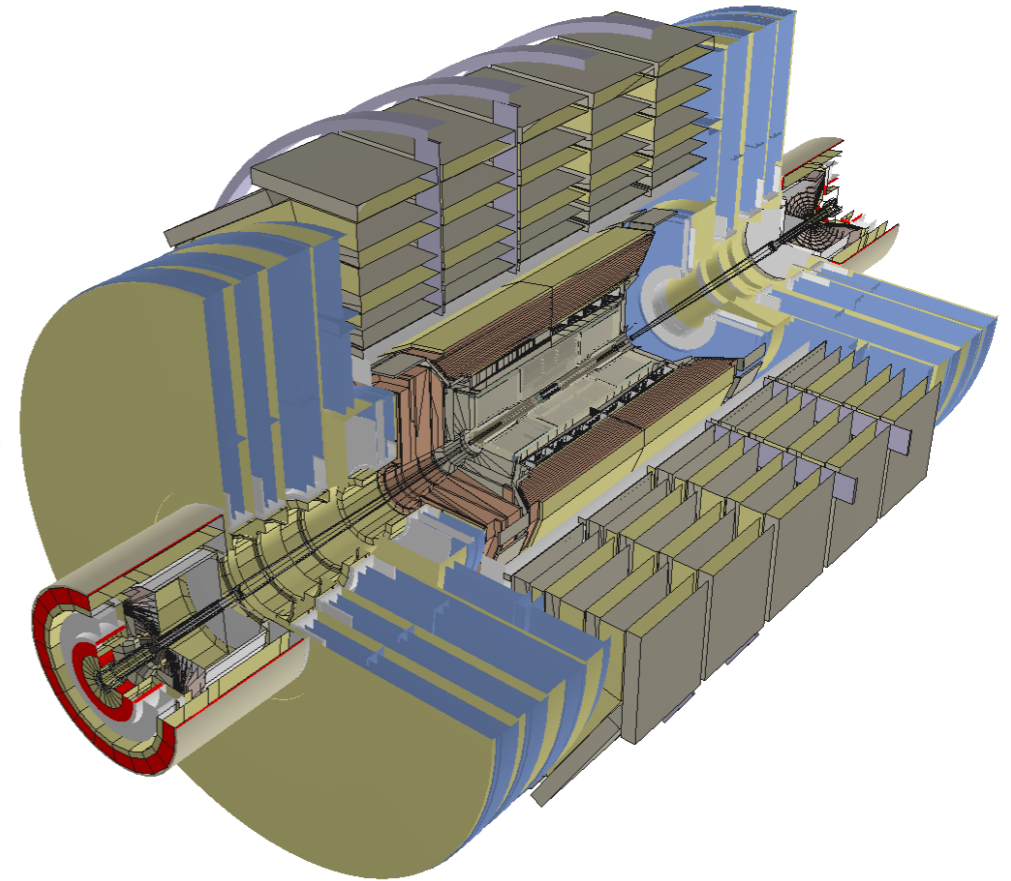

Building blocks

- set of **solids** (shapes) classes
 - box, sphere, tube, etc, etc...
 - boolean operations on solids
- **logical volumes**
 - unpositioned volumes with associated materials and possibly with 'daughter' volumes
 - unpositioned hierarchies of volumes
- **physical volumes**
 - concrete 'placements' of logical volumes
 - can reuse the same logical volume several times

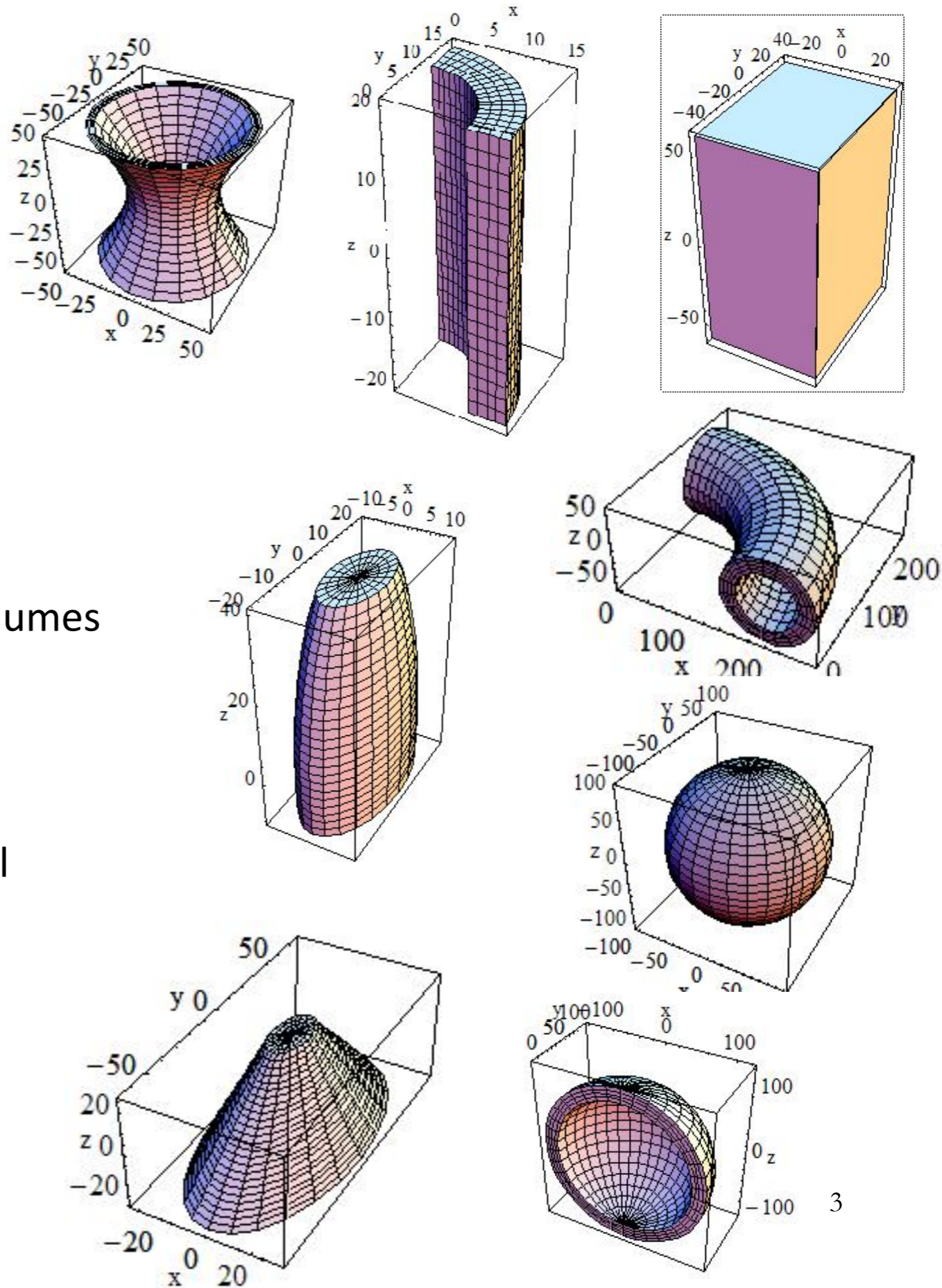

Volumes

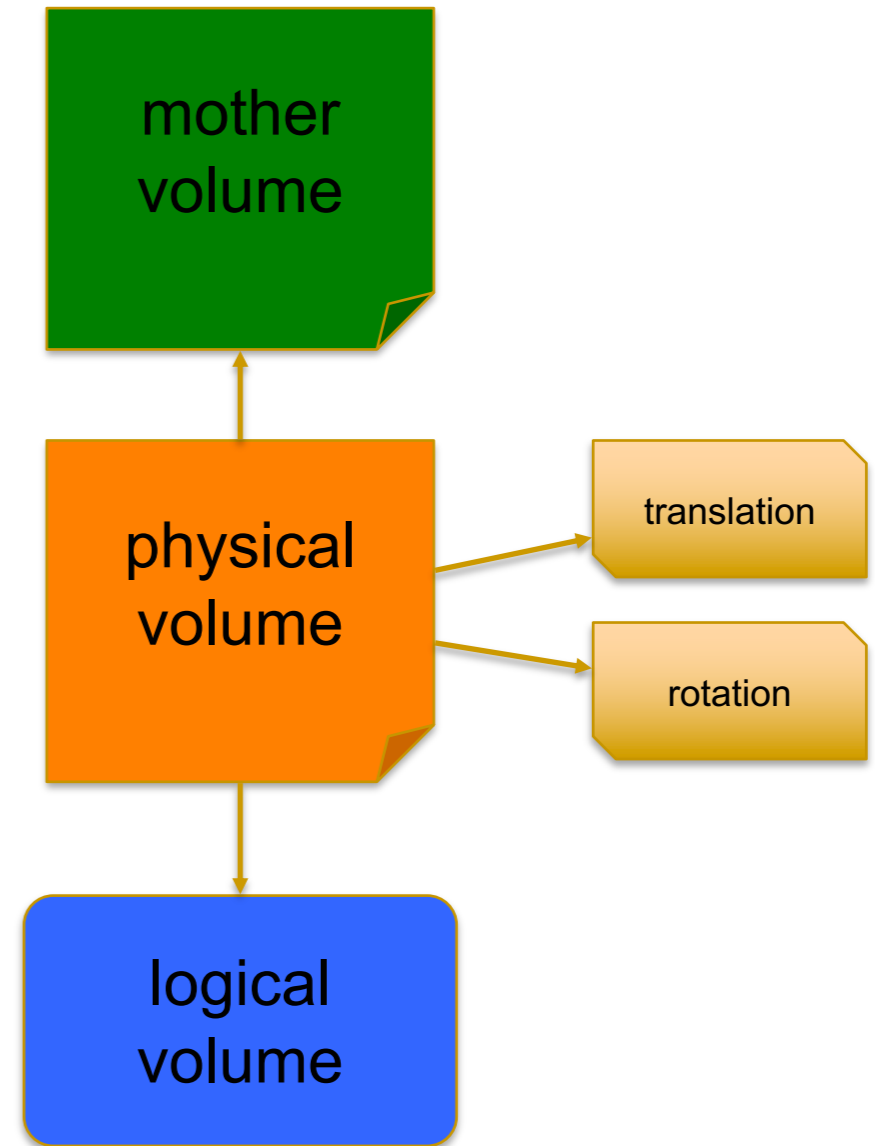
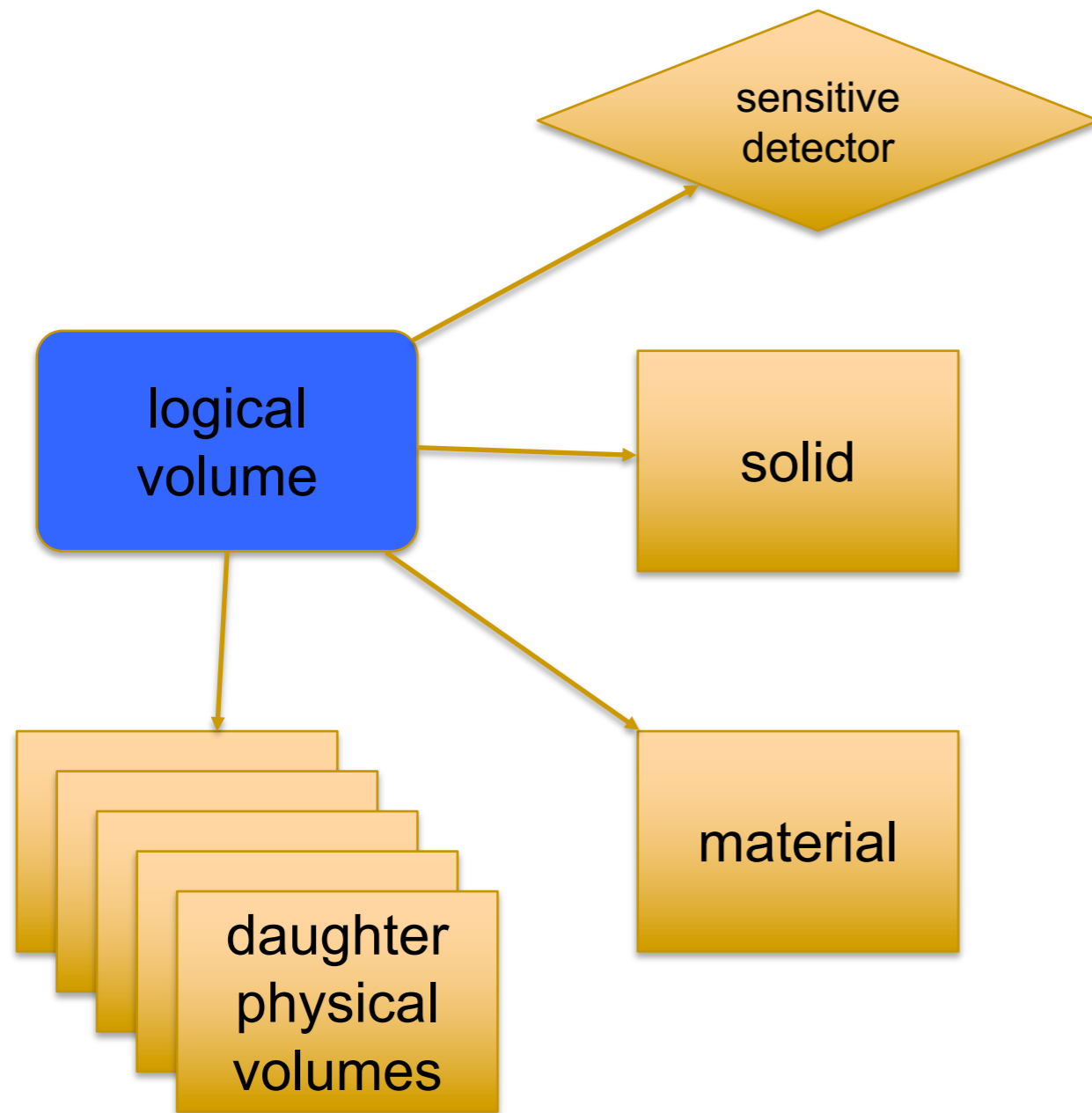

Hierarchy

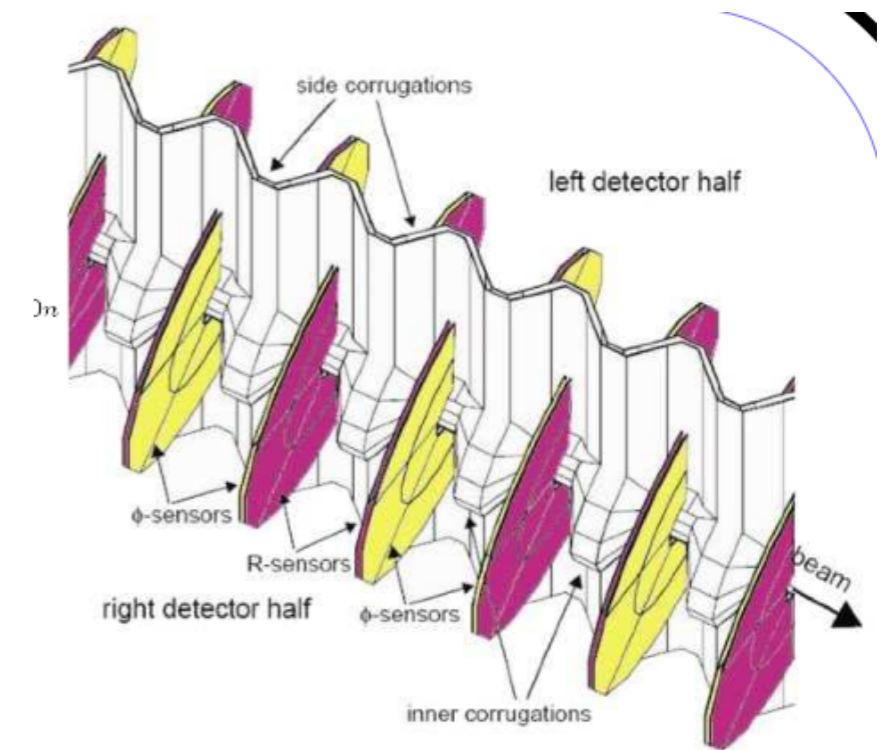
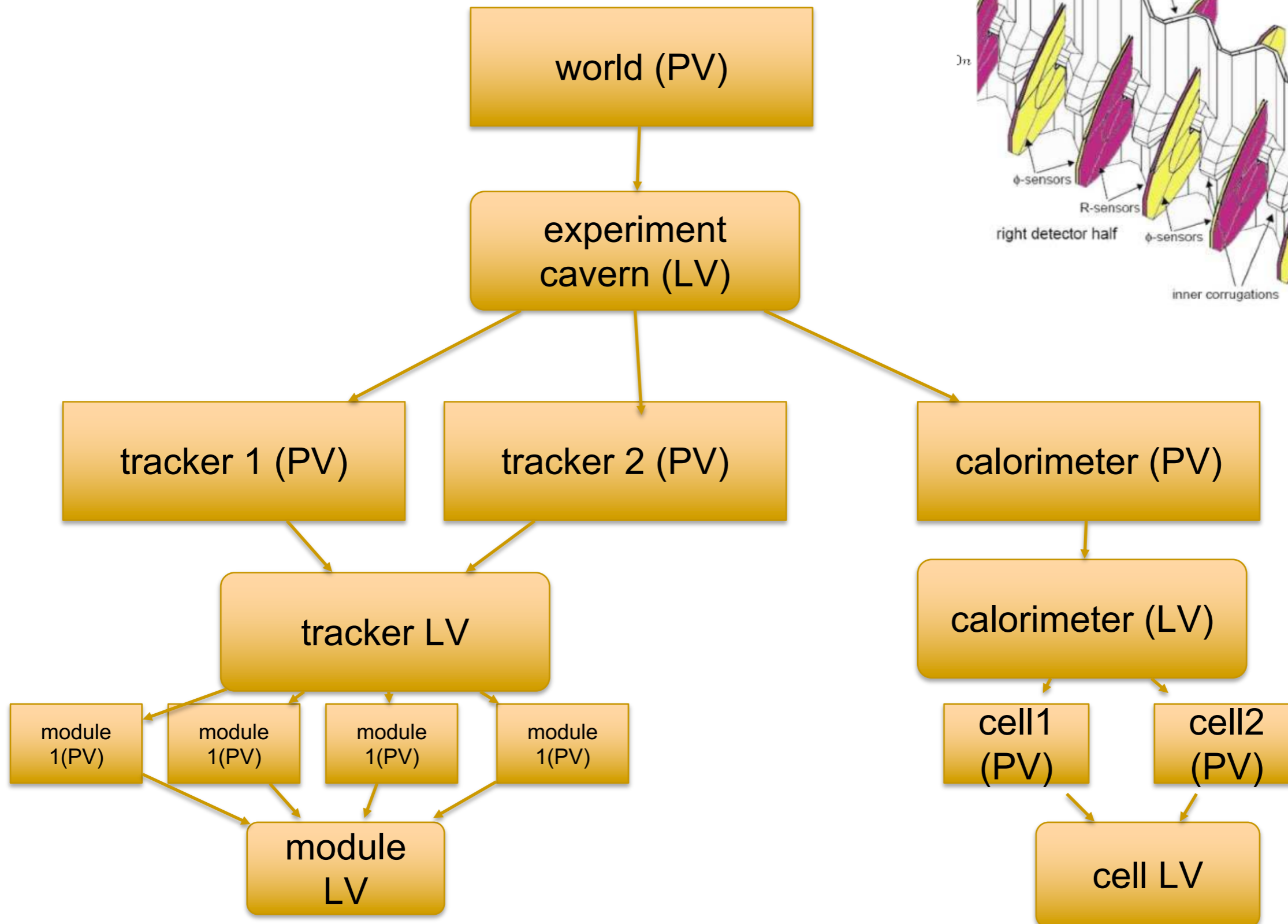

Units

- In Geant4 quantities should be explicitly multiplied by units

- for example :

```
G4double width = 12.5*m;
```

```
G4double density = 2.7*g/cm3;
```

- If no unit is specified, the *internal* G4 unit will be used, but this is discouraged !

- Almost all commonly used units are available.

- The user can define new units.

- Refer to CLHEP: `SystemOfUnits.h`

- Divide a variable by a unit you want to get.

```
G4cout << dE / MeV << “ (MeV)” << G4endl;
```

Describe your detector

- Derive your own concrete class from `G4VUserDetectorConstruction` abstract base class.
- Implementing the method `construct()`:
 - Modularize it according to each detector component or sub-detector:
 1. Construct all necessary materials
 2. Define shapes/solids required to describe the geometry
 3. Construct and place volumes of your detector geometry
 - Define sensitive detectors and identify detector volumes which to associate them
 - Associate magnetic field to detector regions
 - Define visualization attributes for the detector elements

Definition of Materials

- Different kinds of materials can be defined:
 - isotopes <> **G4Isotope**
 - elements <> **G4Element**
 - molecules<> **G4Material**
 - compounds and mixtures <> **G4Material**
- Attributes associated:
 - temperature, pressure, state, density

Isotopes, Elements and Materials

- **G4Isotope** and **G4Element** describe the properties of the *atoms*:
 - Atomic number, number of nucleons, mass of a mole, shell energies
 - Cross-sections per atoms, etc...
- **G4Material** describes the *macroscopic* properties of the matter:
 - temperature, pressure, state, density
 - Radiation length, absorption length, etc...
- **G4Material** is the class used for geometry definition

Elements & Isotopes

- Isotopes can be assembled into elements

```
G4Isotope (const G4String& name,  
          G4int      z,      // atomic number  
          G4int      n,      // number of nucleons  
          G4double   a );   // mass of mole
```

- ... building elements as follows:

```
G4Element (const G4String& name,  
          const G4String& symbol, // element symbol  
          G4int      nIso ); // # of isotopes  
G4Element::AddIsotope (G4Isotope* iso, // isotope  
                      G4double relAbund); // fraction of atoms  
                                          // per volume
```

Material of one element

- Single element material

```
G4double density = 1.390*g/cm3;
```

```
G4double a = 39.95*g/mole;
```

```
G4Material* lAr =
```

```
  new G4Material("liquidArgon", z=18., a, density);
```

Material: molecule

- A Molecule is made of several elements (composition by number of atoms):

```
a = 1.01*g/mole;  
G4Element* e1H =  
    new G4Element("Hydrogen", symbol="H", z=1., a);  
a = 16.00*g/mole;  
G4Element* e1O =  
    new G4Element("Oxygen", symbol="O", z=8., a);  
density = 1.000*g/cm3;  
G4Material* H2O =  
    new G4Material("Water", density, ncomp=2);  
H2O->AddElement(e1H, natoms=2);  
H2O->AddElement(e1O, natoms=1);
```

Material: compound

- Compound: composition by fraction of mass

```
a = 14.01*g/mole;  
G4Element* e1N =  
    new G4Element(name="Nitrogen", symbol="N", z= 7., a);  
a = 16.00*g/mole;  
G4Element* e1O =  
    new G4Element(name="Oxygen", symbol="O", z= 8., a);  
density = 1.290*mg/cm3;  
G4Material* Air =  
    new G4Material(name="Air", density, ncomponents=2);  
Air->AddElement(e1N, 70.0*perCent);  
Air->AddElement(e1O, 30.0*perCent);
```

Material: mixture

- Composition of compound materials

```
G4Element* e1C = ...; // define "carbon" element
G4Material* SiO2 = ...; // define "quartz" material
G4Material* H2O = ...; // define "water" material

density = 0.200*g/cm3;
G4Material* Aerog =
    new G4Material("Aerogel", density, ncomponents=3);
Aerog->AddMaterial(SiO2, fractionmass=62.5*perCent);
Aerog->AddMaterial(H2O, fractionmass=37.4*perCent);
Aerog->AddElement(e1C, fractionmass=0.1*perCent);
```

Example: gas

- It may be necessary to specify temperature and pressure
– (dE/dx computation affected)

```
G4double density = 27.*mg/cm3;  
G4double temperature = 325.*kelvin;  
G4double pressure = 50.*atmosphere;
```

```
G4Material* CO2 =  
    new G4Material("CarbonicGas", density, ncomponents=2  
                  kStateGas, temperature, pressure);  
CO2->AddElement(C,natoms = 1);  
CO2->AddElement(O,natoms = 2);
```

Example: vacuum

- Absolute vacuum does not exist. It is a gas at very low density !
 - Cannot define materials composed of multiple elements through **Z** or **A**, or with $\rho=0$

```
G4double atomicNumber = 1.;
G4double massOfMole = 1.008*g/mole;
G4double density = 1.e-25*g/cm3;
G4double temperature = 2.73*kelvin;
G4double pressure = 3.e-18*pascal;
G4Material* Vacuum =
    new G4Material("interGalactic", atomicNumber,
                  massOfMole, density, kStateGas,
                  temperature, pressure);
```

NIST Manager & Messenger

- NIST database for materials is imported inside Geant4
 - <http://physics.nist.gov/PhysRefData>
- Additional interfaces defined
- UI commands specific for handling materials
- **The best accuracy for the most relevant parameters guaranteed:**
 - Density
 - Mean excitation potential
 - Chemical bounds
 - Element composition
 - Isotope composition
 - Various corrections

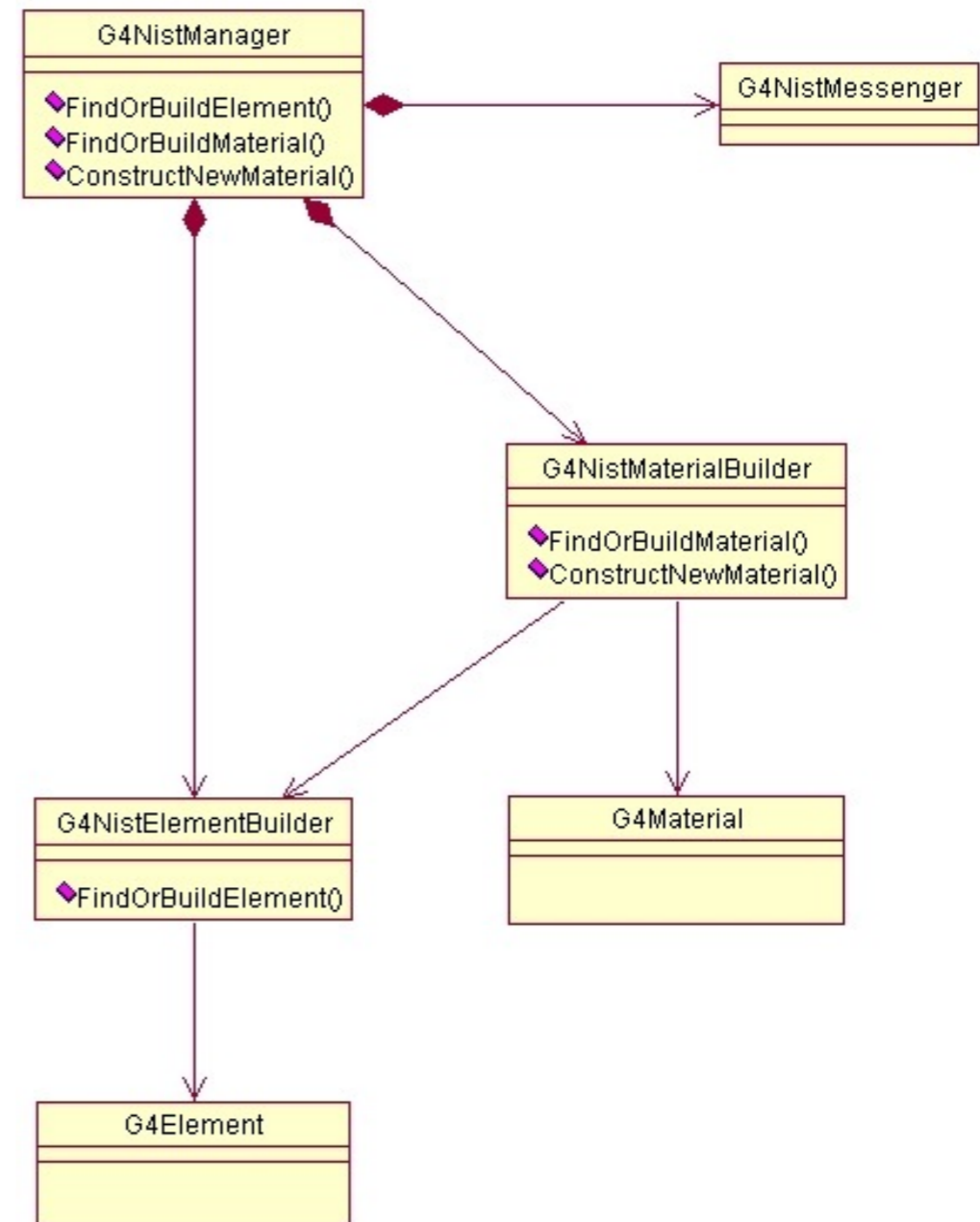

NIST Elements & Isotopes

Z	A	m	error (%)	A_{eff}	
14	Si	22	22.03453	(22)	28.0855(3)
		23	23.02552	(21)	
		24	24.011546	(21)	
		25	25.004107	(11)	
		26	25.992330	(3)	
		27	26.98670476	(17)	
		28	27.9769265327	(20)	92.2297 (7)
		29	28.97649472	(3)	4.6832 (5)
		30	29.97377022	(5)	3.0872 (5)
		31	30.97536327	(7)	
		32	31.9741481	(23)	
		33	32.978001	(17)	
		34	33.978576	(15)	
		35	34.984580	(40)	
		36	35.98669	(11)	
		37	36.99300	(13)	
		38	37.99598	(29)	
		39	39.00230	(43)	
		40	40.00580	(54)	
		41	41.01270	(64)	
		42	42.01610	(75)	

- Natural isotope compositions
- More than 3000 isotope masses
 - Used for elements definition

=====
 ### Elementary Materials from the NIST Data Base
 =====

Z	Name	ChFormula	density(g/cm ³)	I(eV)
1	G4_H	H_2	8.3748e-05	19.2
2	G4_He		0.000166322	41.8
3	G4_Li		0.534	40
4	G4_Be		1.848	63.7
5	G4_B		2.37	76
6	G4_C		2	81
7	G4_N	N_2	0.0011652	82
8	G4_O	O_2	0.00133151	95
9	G4_F		0.00158029	115
10	G4_Ne		0.000838505	137
11	G4_Na		0.971	149
12	G4_Mg		1.74	156
13	G4_Al		2.6989	166
14	G4_Si		2.33	173

NIST Materials

- NIST Elementary materials:
 - H -> Cf (Z = 1 -> 98)
- NIST compounds:
 - e.g. "G4_ADIPOSE_TISSUE_IRCP"
- HEP and Nuclear materials:
 - e.g. Liquid Ar, PbWO
- It is possible to build mixtures of NIST and user-defined materials

=====
 ### Compound Materials from the NIST Data Base
 =====

N	Name	ChFormula	density(g/cm ³)	I(eV)
13	G4_Adipose_Tissue		0.92	63.2
	1	0.119477		
	6	0.63724		
	7	0.00797		
	8	0.232333		
	11	0.0005		
	12	2e-05		
	15	0.00016		
	16	0.00073		
	17	0.00119		
	19	0.00032		
	20	2e-05		
	26	2e-05		
	30	2e-05		
4	G4_Air		0.00120479	85.7
	6	0.000124		
	7	0.755268		
	8	0.231781		
	18	0.012827		
2	G4_CsI		4.51	553.1
	53	0.47692		
	55	0.52308		

How to use the NIST DB

- No need to predefine elements and materials
- Retrieve materials from NIST manager:

```
G4NistManager* manager = G4NistManager::Instance();
```

```
G4Material* H2O = manager->FindOrBuildMaterial("G4_WATER");
```

```
G4Material* mat = manager->ConstructNewMaterial("name",  
                                             const std::vector<G4String>& elements,  
                                             const std::vector<G4double>& weights,  
                                             G4double density, G4bool isotopes);
```

```
G4double isotopeMass = manager->GetMass(G4int Z, G4int N);
```

- Some UI commands ...

```
/material/nist/printElement ← print defined elements
```

```
/material/nist/listMaterials ← print defined materials
```

Creating a Detector Volume

- Start with its Shape & Size
 - Box 3x5x7 cm, sphere R=8m
 - Add properties:
 - material, B/E field,
 - make it sensitive
 - Place it in another volume
 - in one place
 - repeatedly using a function
- *Solid*
- *Logical-Volume*
- *Physical-Volume*

Solids

- Solids defined in Geant4:
 - CSG (Constructed Solid Geometry) solids
 - G4Box, G4Tubs, G4Cons, G4Trd, ...
 - Analogous to simple GEANT3 CSG solids
 - Specific solids (CSG like)
 - G4Polycone, G4Polyhedra, G4Hype, ...
 - G4TwistedTubs, G4TwistedTrap, ...
 - Boolean solids
 - G4UnionSolid, G4SubtractionSolid, ...

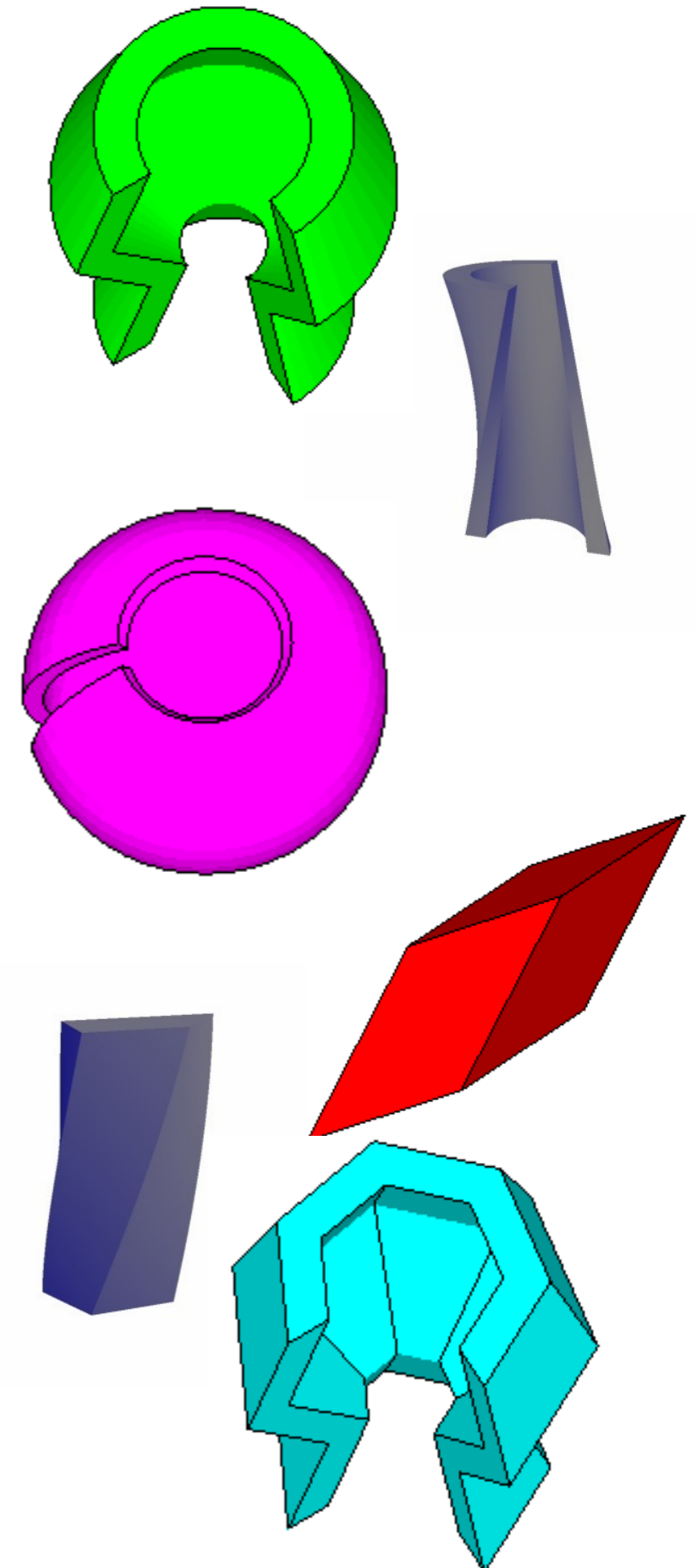

CSG: G4Tubs, G4Cons

```
G4Tubs (const G4String& pname, // name
         G4double pRmin, // inner radius
         G4double pRmax, // outer radius
         G4double pDz, // z half length
         G4double pSphi, // starting Phi
         G4double pDphi); // segment angle
```

```
G4Cons (const G4String& pname, // name
         G4double pRmin1, // inner radius -pDz
         G4double pRmax1, // outer radius -pDz
         G4double pRmin2, // inner radius +pDz
         G4double pRmax2, // outer radius +pDz
         G4double pDz, // z half length
         G4double pSphi, // starting Phi
         G4double pDphi); // segment angle
```

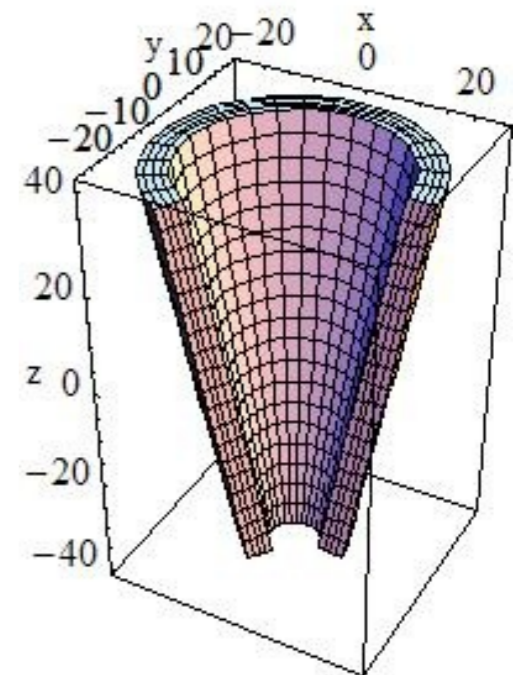
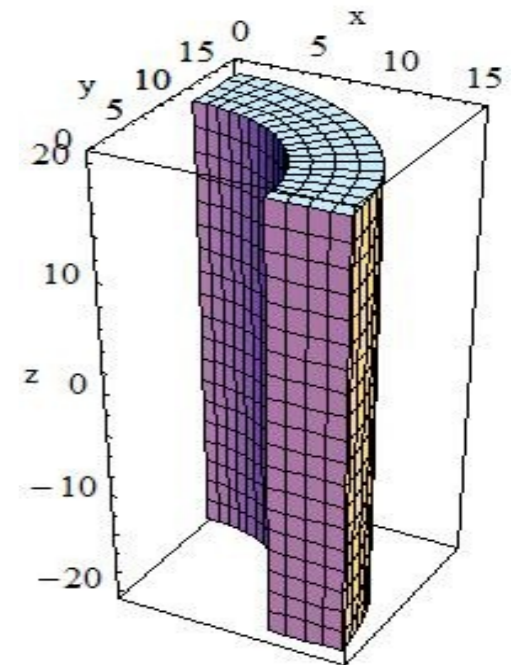

Specific CSG Solids: G4Polycone

```
G4Polycone(const G4String& pName,  
           G4double phiStart,  
           G4double phiTotal,  
           G4int numRZ,  
           const G4double r[],  
           const G4double z[]);
```

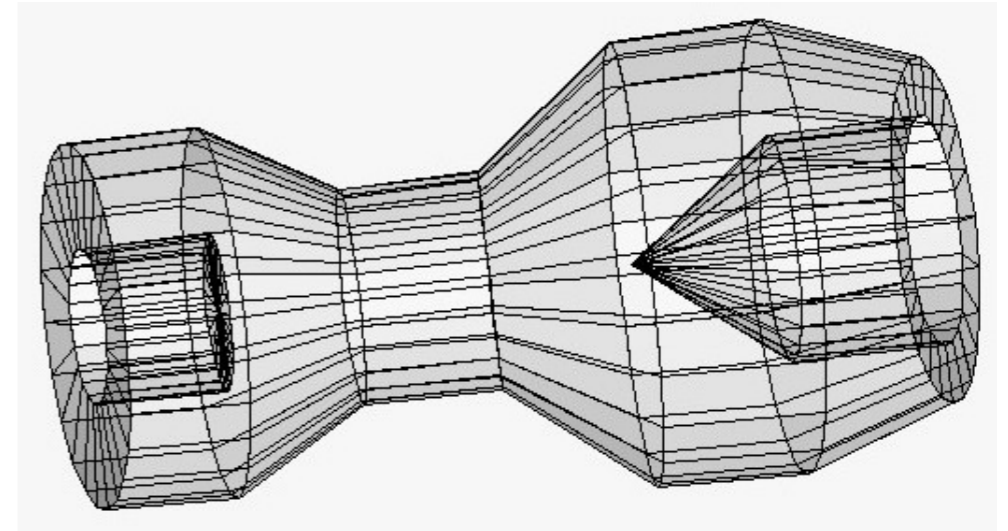

- `numRZ` - numbers of corners in the r, z space
- r, z - coordinates of corners
- Also available additional constructor using planes

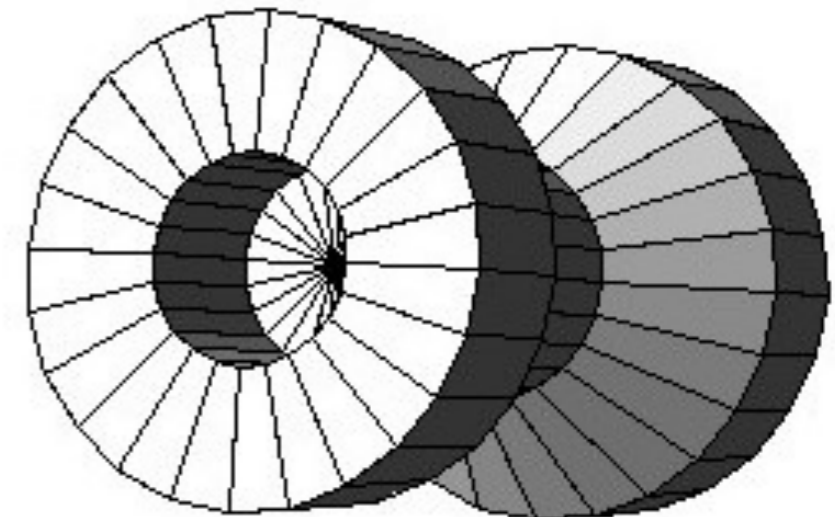

Boolean Solids

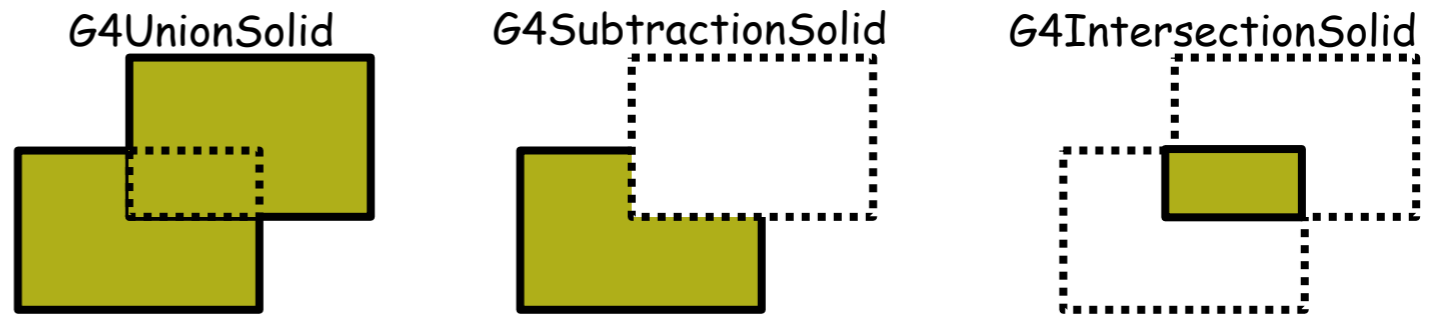

- Solids can be combined using boolean operations:
 - **G4UnionSolid, G4SubtractionSolid, G4IntersectionSolid**
 - Requires: 2 solids, 1 boolean operation, and an (optional) transformation for the 2nd solid
 - 2nd solid is positioned relative to the coordinate system of the 1st solid
 - Component solids must not be disjoint and must well intersect

```
G4Box box("Box", 20, 30, 40);
G4Tubs cylinder("Cylinder", 0, 50, 50, 0, 2*M_PI); // r: 0 -> 50
                                                    // z: -50 -> 50
                                                    // phi: 0 -> 2 pi
G4UnionSolid union("Box+Cylinder", &box, &cylinder);
G4IntersectionSolid intersect("Box Intersect Cylinder", &box, &cylinder);
G4SubtractionSolid subtract("Box-Cylinder", &box, &cylinder);
```

- Solids can be either CSG or other Boolean solids
- Note: tracking cost for the navigation in a complex Boolean solid is proportional to the number of constituent solids

G4LogicalVolume

```
G4LogicalVolume(G4VSolid* pSolid, G4Material* pMaterial,  
               const G4String& name, G4FieldManager* pFieldMgr=0,  
               G4VSensitiveDetector* pSDetector=0,  
               G4UserLimits* pULimits=0,  
               G4bool optimise=true);
```

- Contains all information of volume except position:
 - Shape and dimension (G4VSolid)
 - Material, sensitivity, visualization attributes
 - Position of daughter volumes
 - Magnetic field, User limits
 - Shower parameterisation
- Physical volumes of same type can share a logical volume.
- The pointers to solid and material must be NOT null
- Once created it is automatically entered in the LV store
- It is not meant to act as a base class

Geometrical hierarchy

- Mother and daughter volumes
 - A volume is placed in its mother volume
 - Position and rotation of the daughter volume is described with respect to the local coordinate system of the mother volume
 - The origin of the mother's local coordinate system is at the center of the mother volume
 - Daughter volumes cannot protrude from the mother volume
 - Daughter volumes cannot overlap
 - One or more volumes can be placed in a mother volume

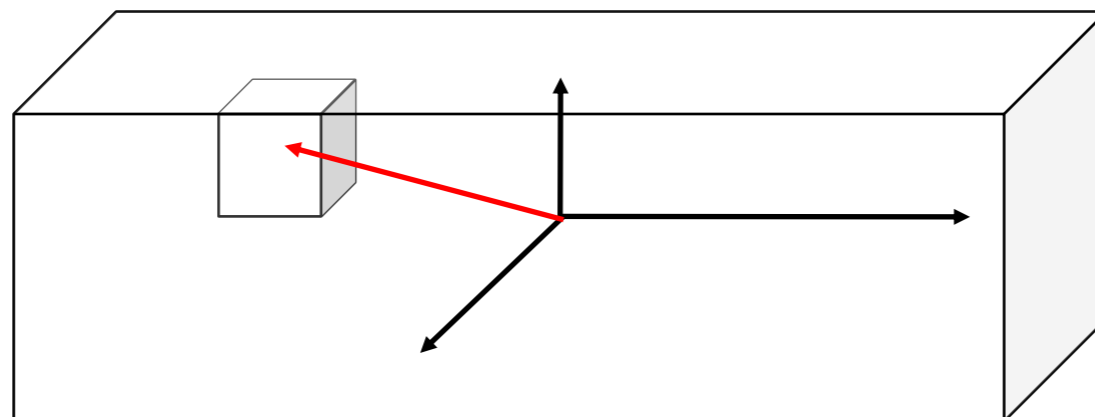

Geometrical hierarchy

- Note that the mother-daughter relationship is an information of **G4LogicalVolume**
 - If the mother volume is placed more than once, all daughters by definition appear in each placed physical volume
- The **world volume** must be a unique physical volume which fully contains with some margin all the other volumes
 - The world volume defines the **global coordinate system**. The origin of the global coordinate system is at the center of the world volume
 - Position of a track is given with respect to the global coordinate system

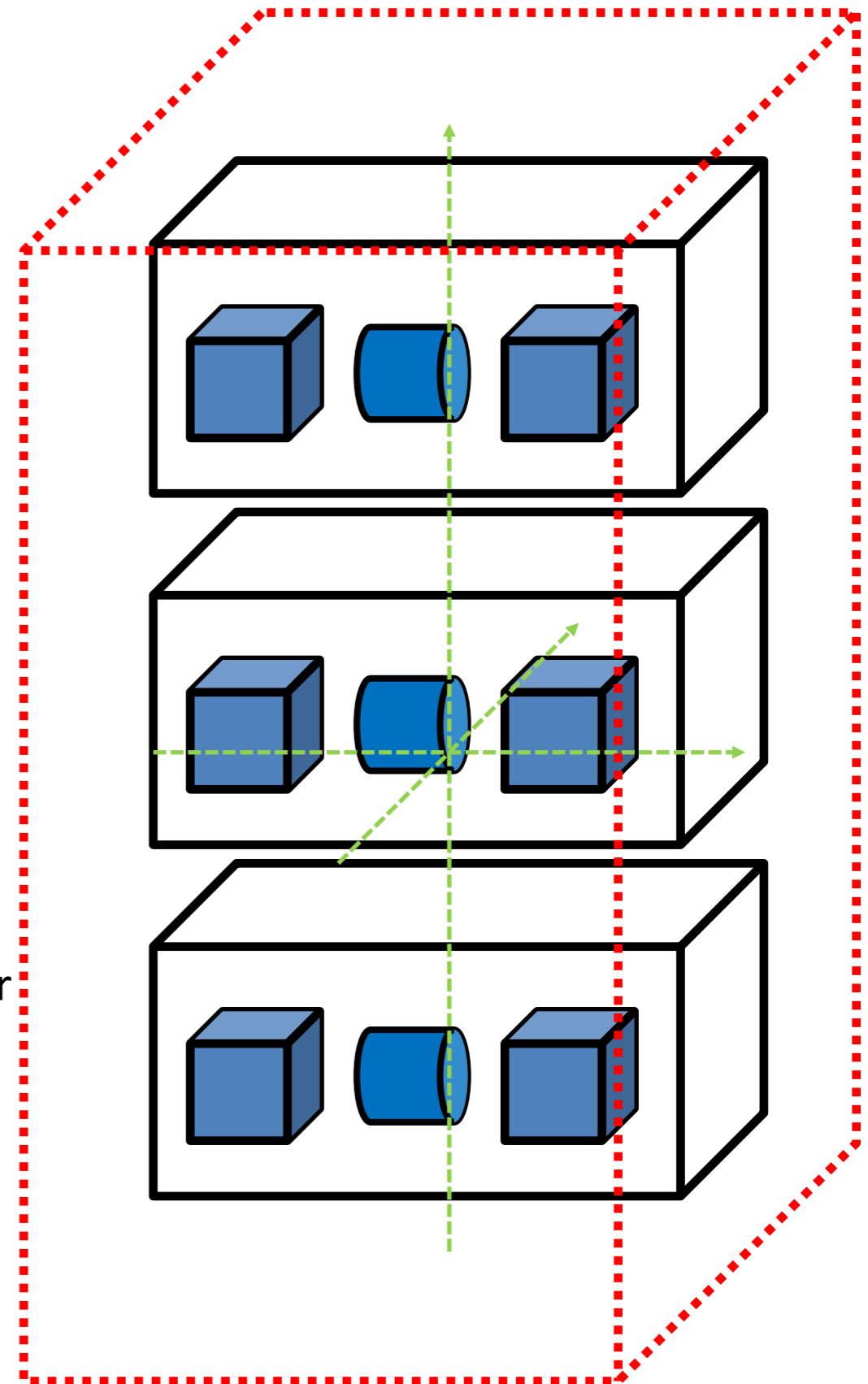

G4PVPlacement

```
G4PVPlacement(G4RotationMatrix* pRot,          // rotation of mother frame
              const G4ThreeVector& tlate,     // position in rotated frame
              G4LogicalVolume* pCurrentLogical,
              const G4String& pName,
              G4LogicalVolume* pMotherLogical,
              G4bool pMany,                   // not used. Set it to false...
              G4int pCopyNo,                 // unique arbitrary index
              G4bool pSurfChk=false);       // optional overlap check
```

- Single volume positioned relatively to the mother volume
 - In a frame rotated and translated relative to the coordinate system of the mother volume
- Three additional constructors:
 - A simple variation: specifying the mother volume as a pointer to its physical volume instead of its logical volume.
 - Using **G4Transform3D** to represent the direct rotation and translation of the solid instead of the frame (*alternative constructor*)
 - The combination of the two variants above

G4PVPlacement

Rotation of mother frame ...

```
G4PVPlacement(G4RotationMatrix* pRot,          // rotation of mother frame
              const G4ThreeVector& tlate,     // position in mother frame
              G4LogicalVolume* pCurrentLogical,
              const G4String& pName,
              G4LogicalVolume* pMotherLogical,
              G4bool pMany,                   // not used. Set it to false..
              G4int pCopyNo,                  // unique arbitrary index
              G4bool pSurfChk=false );       // optional overlap check
```

- Single volume positioned relatively to the mother volume

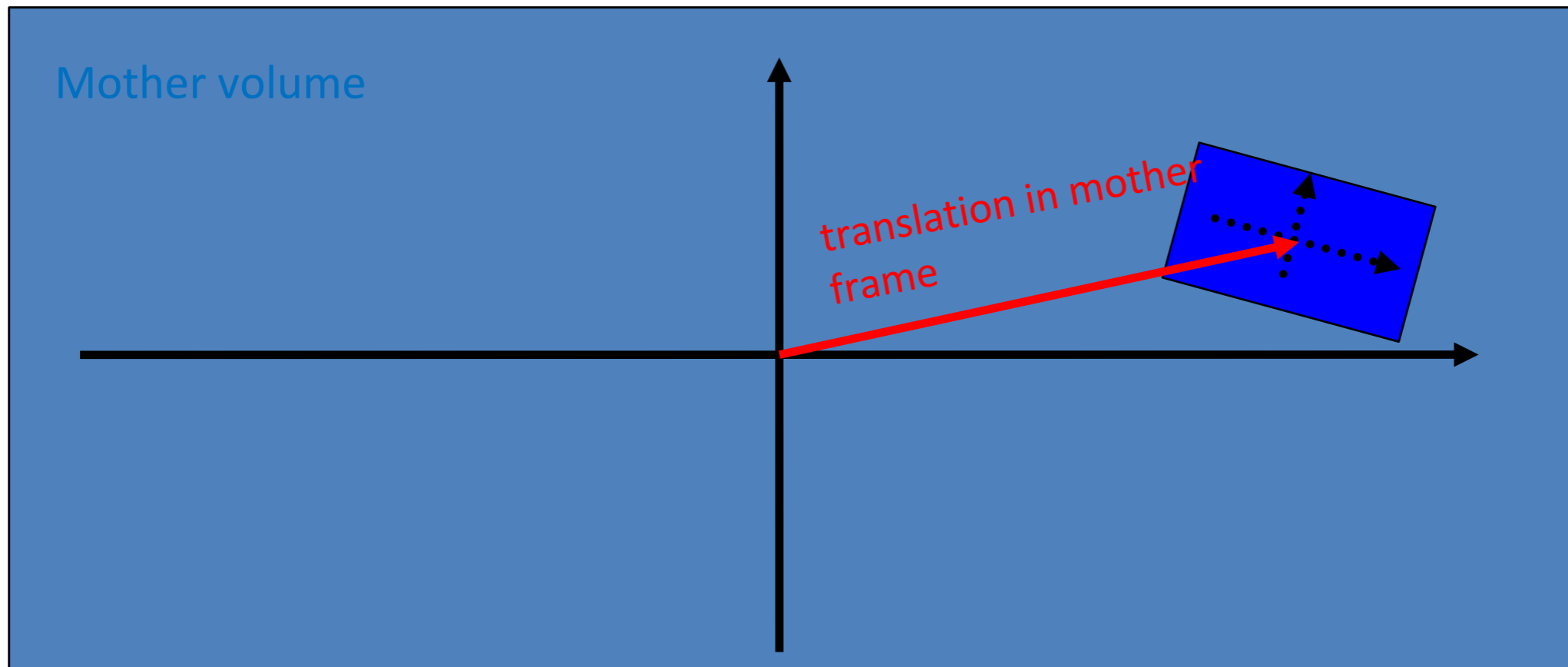

G4PVPlacement

Rotation in mother frame ...

```
G4PVPlacement( G4Transform3D( G4RotationMatrix &pRot,          // rotation of daughter frame
                          const G4ThreeVector &tlate), // position in mother frame
              G4LogicalVolume *pDaughterLogical,
              const G4String &pName,
              G4LogicalVolume *pMotherLogical,
              G4bool pMany,          // not used, set it to false...
              G4int pCopyNo,        // unique arbitrary integer
              G4bool pSurfChk=false ); // optional overlap check
```

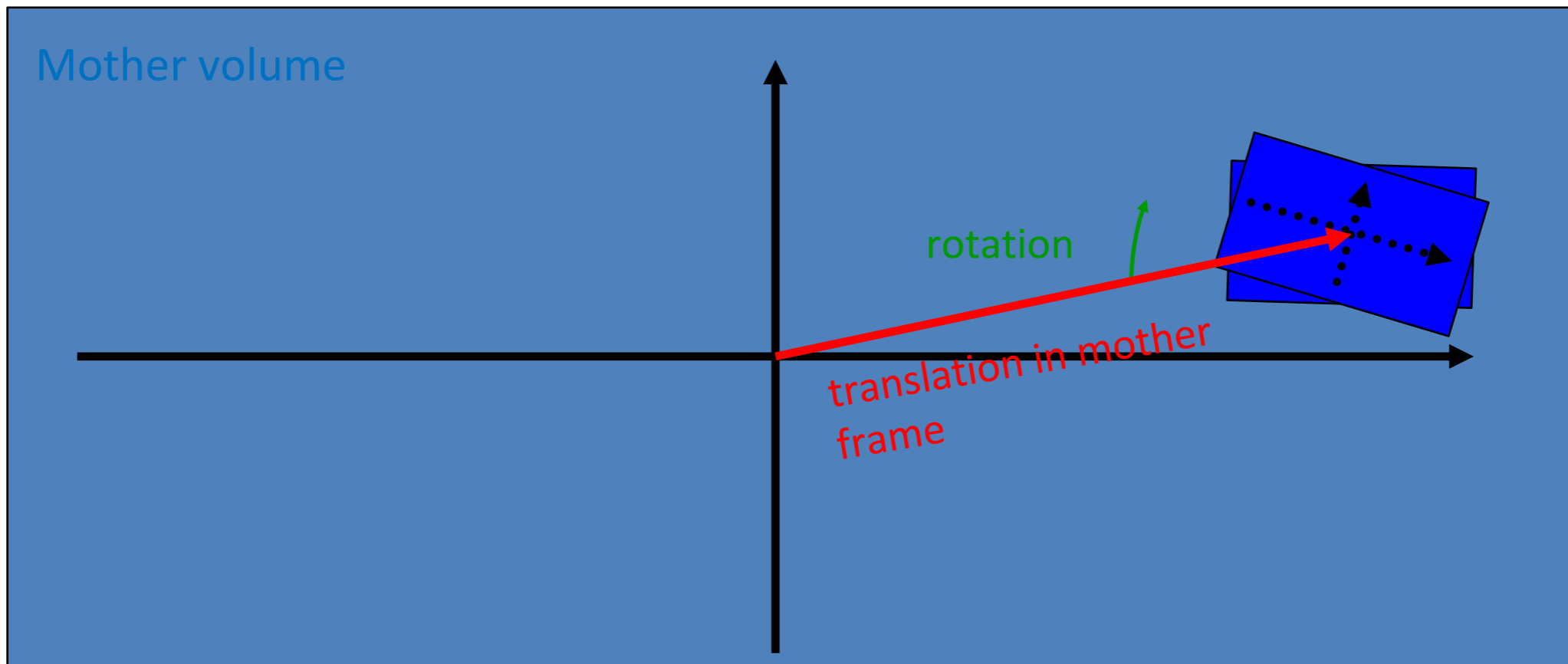

Detector geometry components

- Basic strategy

```
G4Material* pBoxMaterial = new G4Material(...);
```

```
G4VSolid* pBoxSolid =  
  new G4Box("aBoxSolid", 1.*m, 2.*m, 3.*m);
```

```
G4LogicalVolume* pBoxLog =  
  new G4LogicalVolume( pBoxSolid, pBoxMaterial,  
                      "aBoxLog", 0, 0, 0);
```

```
G4VPhysicalVolume* aBoxPhys =  
  new G4PVPlacement( pRotation,  
                    G4ThreeVector(posX, posY, posZ),  
                    pBoxLog, "aBoxPhys", pMotherLog,  
                    0, copyNo);
```

- A unique physical volume which represents the experimental area must exist and fully contains all other components

➤ The world volume

Step 1

Create the geom.
object : box

Step 2

Assign properties
to object : material

Step 3

Place it in the
coordinate system of
mother volume

Conclusion

- we know know how to describe our detector geometry
 - we create materials
 - instantiate solids
 - build the volumes hierarchy

Backup

System of Units

- System of units are defined in CLHEP, based on:
 - millimetre (**mm**), nanosecond (**ns**), Mega eV (**MeV**), positron charge (**eplus**) degree Kelvin (**kelvin**), the amount of substance (**mole**), luminous intensity (**candela**), radian (**radian**), steradian (**steradian**)
- All other units are computed from the basic ones
- In output, Geant4 can choose the most appropriate unit to use. Just specify the *category* for the data (**Length**, **Time**, **Energy**, etc...):

```
G4cout << G4BestUnit(StepSize, "Length");
```

`StepSize` will be printed in **km**, **m**, **mm** or ... **fermi**, depending on its value

Defining new units

- New units can be defined directly as constants, or (suggested way) via `G4UnitDefinition`
 - `G4UnitDefinition` (name, symbol, category, value)
- Example (mass thickness):
 - `G4UnitDefinition` ("grampercm2", "g/cm2",
"MassThickness", g/cm2);
 - The new category "**MassThickness**" will be registered in the kernel in `G4UnitsTable`
- To print the list of units:
 - From the code
`G4UnitDefinition::PrintUnitsTable()`;
 - At run-time, as UI command:
`Idle> /units/list`

Kinds of G4VPhysicalVolume

- G4PVPlacement 1 Placement = One Volume
 - A volume instance positioned once in a mother volume
- G4PVParameterised 1 Parameterised = Many Volumes
 - Parameterised by the copy number
 - Shape, size, material, position and rotation can be parameterised, by implementing a concrete class of **G4VPVParameterisation**.
 - Reduction of memory consumption
 - Parameterisation can be used only for volumes that either a) have no further daughters or b) are identical in size & shape.
- G4PVReplica 1 Replica = Many Volumes
 - Slicing a volume into smaller pieces (if it has a symmetry)

Physical Volumes

- **Placement:** it is one positioned volume
- **Repeated:** a volume placed many times
 - can represent any number of volumes
 - reduces use of memory.
 - Replica
 - simple repetition, similar to G3 divisions
 - Parameterised
- A **mother** volume can contain **either**
 - **many placement** volumes OR
 - **one repeated** volume

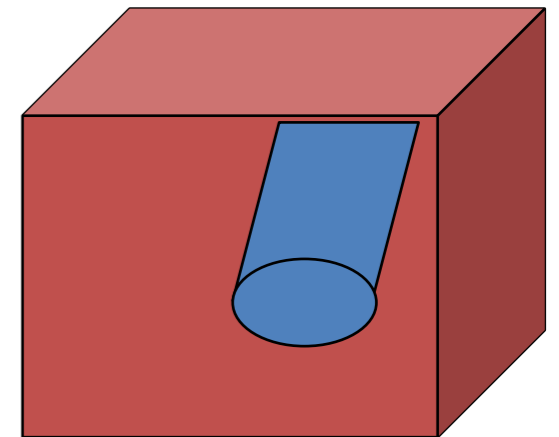

placement

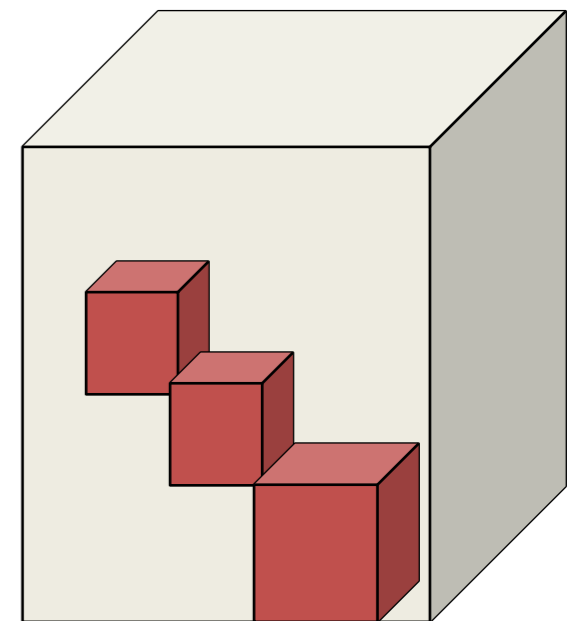

repeated

Parameterised Physical Volumes

- User written functions define:
 - the size of the solid (dimensions)
 - Function **ComputeDimensions (...)**
 - where it is positioned (transformation)
 - Function **ComputeTransformations (...)**
- Optional:
 - the type of the solid
 - Function **ComputeSolid (...)**
 - the material
 - Function **ComputeMaterial (...)**
- Limitations:
 - Applies to a limited set of solids
 - Daughter volumes allowed only for special cases
- Very powerful
 - Consider parameterised volumes as “leaf” volumes

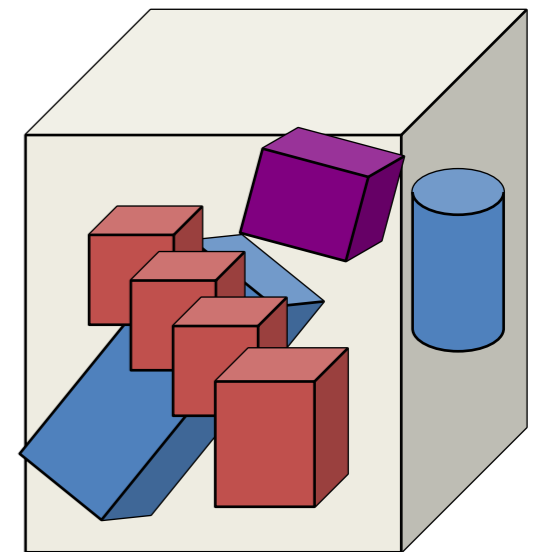

Uses of Parameterised Volumes

- Complex detectors
 - with large repetition of volumes
 - regular or irregular
- Medical applications
 - the material in animal tissue is measured
 - cubes with varying material

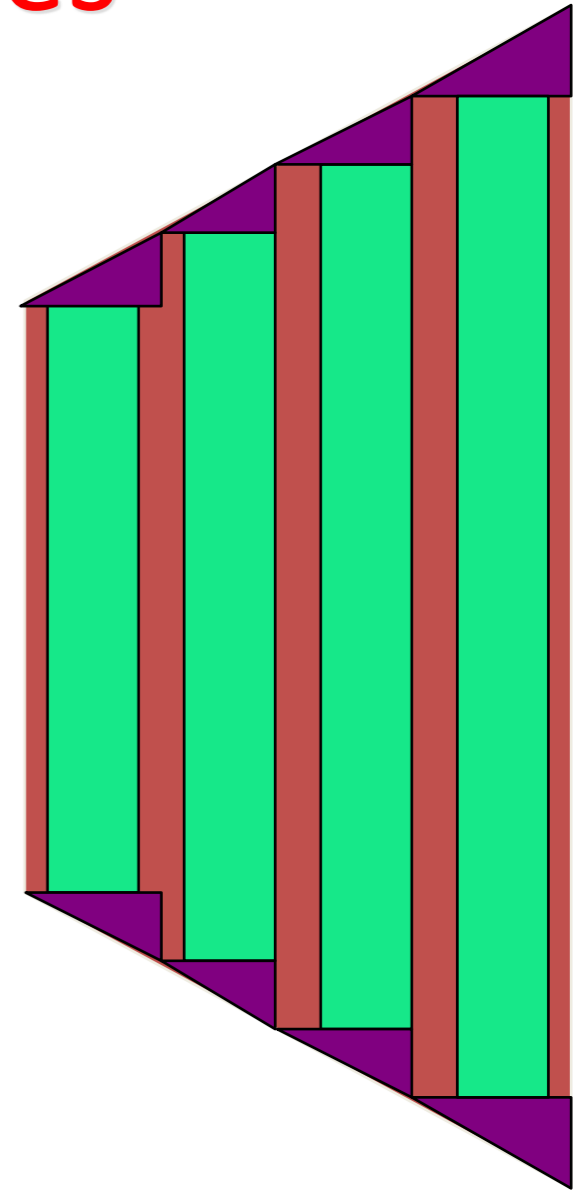

G4PVParameterised

```
G4PVParameterised(const G4String& pName,  
                  G4LogicalVolume* pCurrentLogical,  
                  G4LogicalVolume* pMotherLogical,  
                  const EAxis pAxis,  
                  const G4int nReplicas,  
                  G4VPVParameterisation* pParam,  
                  G4bool pSurfChk=false);
```

- Replicates the volume `nReplicas` times using the parameterisation `pParam`, within the mother volume
- The positioning of the replicas is dominant along the specified Cartesian axis
 - If `kUndefined` is specified as axis, 3D voxelisation for optimisation of the geometry is adopted
- Represents many touchable detector elements differing in their positioning and dimensions. Both are calculated by means of a `G4VPVParameterisation` object
- Alternative constructor using pointer to physical volume for the mother

Parameterisation

example - 1

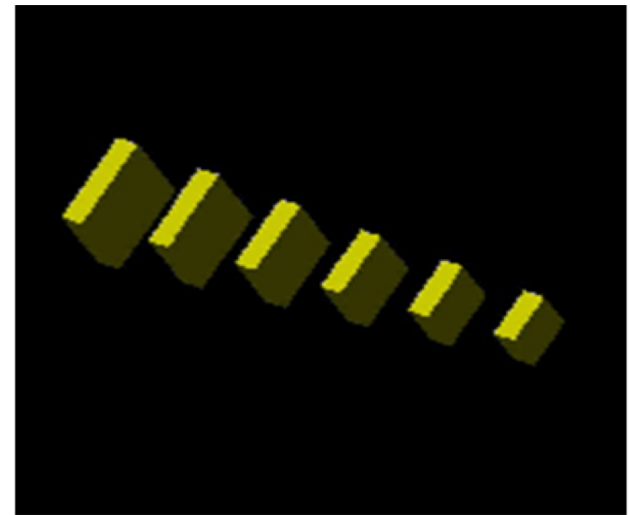

```
G4VSolid* solidChamber = new G4Box("chamber", 100*cm, 100*cm, 10*cm);
G4LogicalVolume* logicChamber =
    new G4LogicalVolume(solidChamber, ChamberMater, "Chamber", 0, 0, 0);
G4double firstPosition = -trackerSize + 0.5*ChamberWidth;
G4double firstLength = fTrackerLength/10;
G4double lastLength = fTrackerLength;
G4VPVParameterisation* chamberParam =
    new ChamberParameterisation( NbOfChambers, firstPosition,
                                ChamberSpacing, ChamberWidth,
                                firstLength, lastLength);
G4VPhysicalVolume* physChamber =
    new G4PVParameterised( "Chamber", logicChamber, logicTracker,
                           kZAxis, NbOfChambers, chamberParam);
```

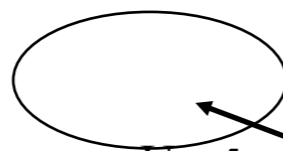

Use **kUndefined** for activating 3D voxelisation for optimisation

Parameterisation

example - 2

```
class ChamberParameterisation : public G4VPVParameterisation
{
public:
    ChamberParameterisation( G4int NoChambers, G4double startZ,
                            G4double spacing, G4double widthChamber,
                            G4double lenInitial, G4double lenFinal );
    ~ChamberParameterisation();
    void ComputeTransformation (const G4int copyNo,
                               G4VPhysicalVolume* physVol) const;
    void ComputeDimensions (G4Box& trackerLayer, const G4int copyNo,
                            const G4VPhysicalVolume* physVol) const;
}
```

Parameterisation

example - 3

```
void ChamberParameterisation::ComputeTransformation
(const G4int copyNo, G4VPhysicalVolume* physVol) const
{
    G4double Zposition= fStartZ + (copyNo+1) * fSpacing;
    G4ThreeVector origin(0, 0, Zposition);
    physVol->SetTranslation(origin);
    physVol->SetRotation(0);
}
void ChamberParameterisation::ComputeDimensions
(G4Box& trackerChamber, const G4int copyNo,
const G4VPhysicalVolume* physVol) const
{
    G4double halfLength= fHalfLengthFirst + copyNo * fHalfLengthIncr;
    trackerChamber.SetXHalfLength(halfLength);
    trackerChamber.SetYHalfLength(halfLength);
    trackerChamber.SetZHalfLength(fHalfWidth);
}
```

Replicated Physical Volumes

- The mother volume is sliced into replicas, all of the same size and dimensions.
- Represents many touchable detector elements differing only in their positioning.
- Replication may occur along:
 - Cartesian axes (X, Y, Z) – slices are considered perpendicular to the axis of replication
 - Coordinate system at the center of each replica
 - Radial axis (Rho) – cons/tubs sections centered on the origin and un-rotated
 - Coordinate system same as the mother
 - Phi axis (Phi) – phi sections or wedges, of cons/tubs form
 - Coordinate system rotated such as that the X axis bisects the angle made by each wedge

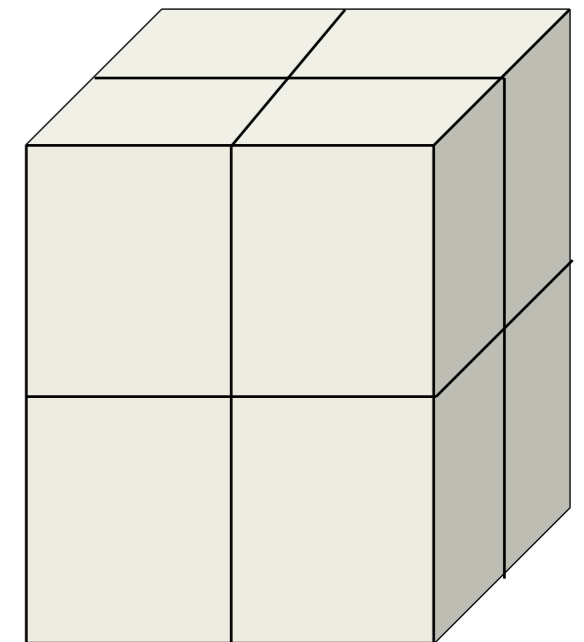
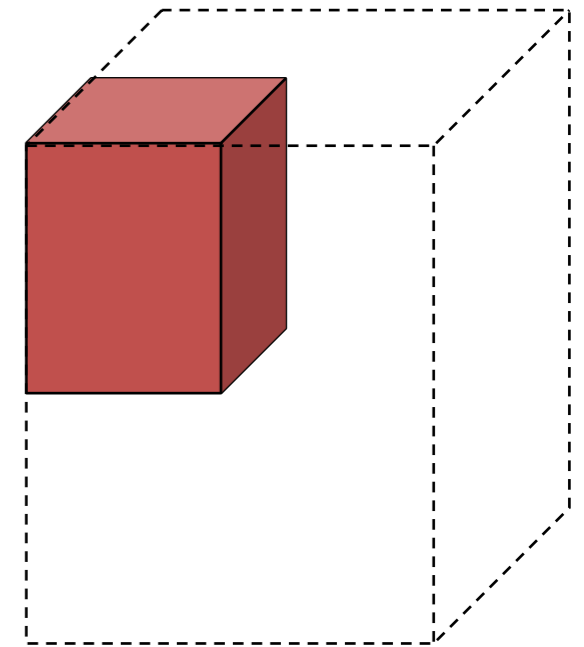

repeated

G4PVReplica

```
G4PVReplica(const G4String& pName,  
            G4LogicalVolume* pCurrentLogical,  
            G4LogicalVolume* pMotherLogical,  
            const EAxis pAxis,  
            const G4int nReplicas,  
            const G4double width,  
            const G4double offset=0);
```

- Alternative constructor:
 - Using pointer to physical volume for the mother
- An **offset** can be associated
 - Only to a mother offset along the axis of replication
- Features and restrictions:
 - Replicas can be placed inside other replicas
 - Normal placement volumes can be placed inside replicas, assuming no intersection or overlaps with the mother volume or with other replicas
 - No volume can be placed inside a *radial* replication
 - Parameterised volumes cannot be placed inside a replica

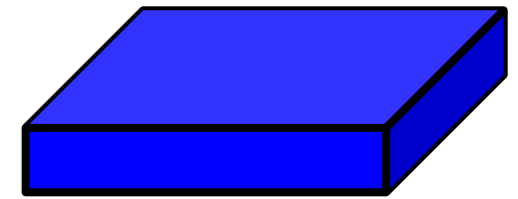

a daughter logical
volume to be
replicated

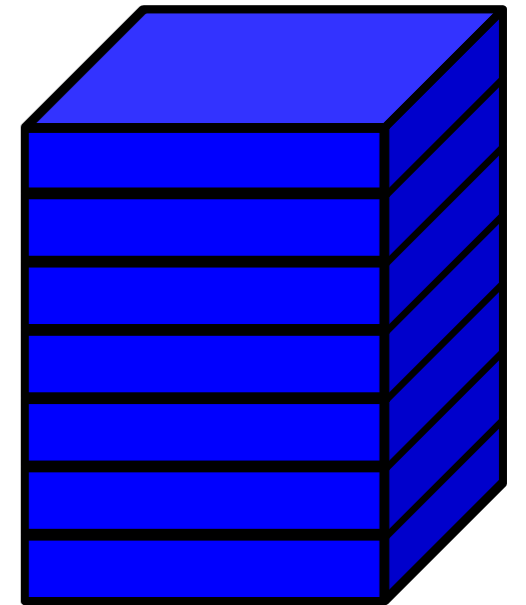

mother volume

Replica – axis, width, offset

- Cartesian axes - **kXaxis**, **kYaxis**, **kZaxis**

- offset shall not be used

- Center of n-th daughter is given as

$$-width * (nReplicas - 1) * 0.5 + n * width$$

- Radial axis - **kRaxis**

- Center of n-th daughter is given as

$$width * (n + 0.5) + offset$$

- Phi axis - **kPhi**

- Center of n-th daughter is given as

$$width * (n + 0.5) + offset$$

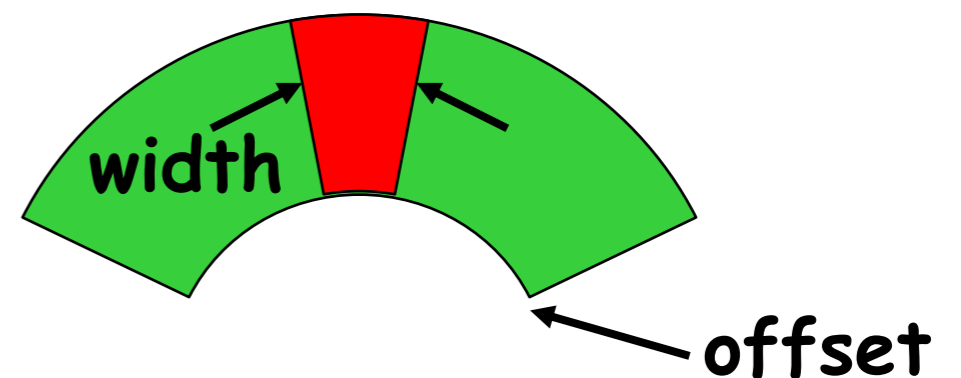
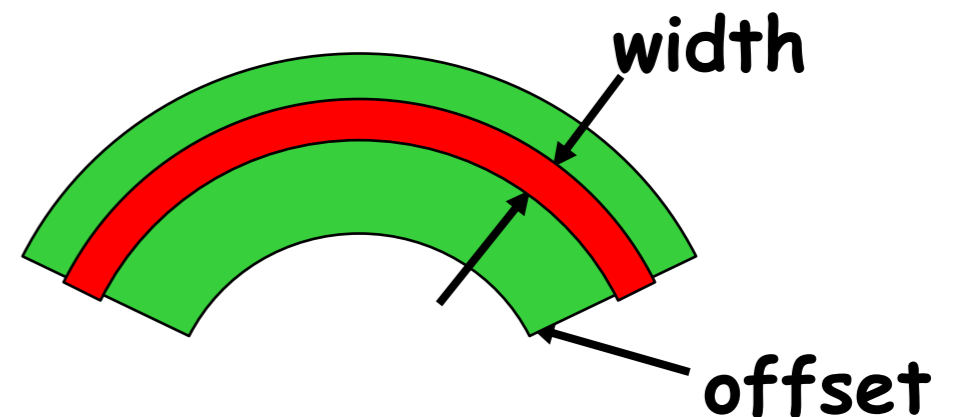
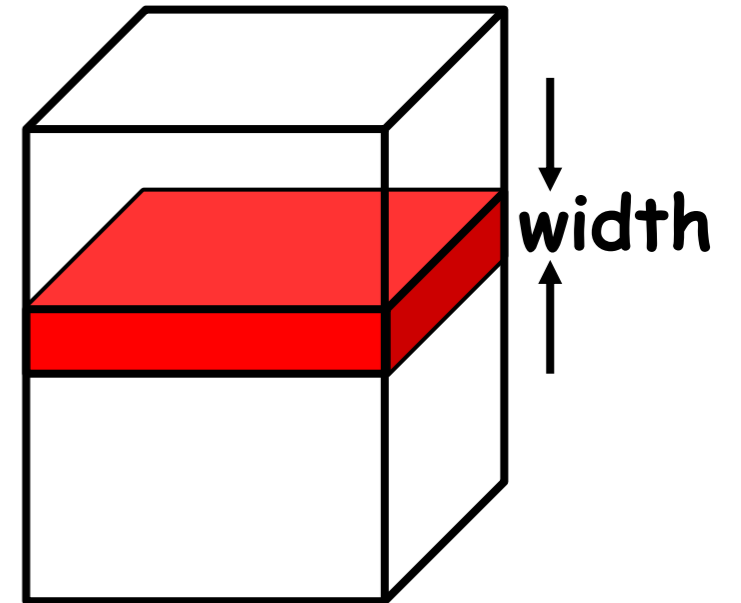

Replication example

```
G4double tube_dPhi = 2.* M_PI * rad;
G4VSolid* tube =
    new G4Tubs("tube",20*cm,50*cm,30*cm,0.,tube_dPhi);
G4LogicalVolume * tube_log =
    new G4LogicalVolume(tube, Air, "tubeL", 0, 0, 0);
G4VPhysicalVolume* tube_phys =
    new G4PVPlacement(0,G4ThreeVector(-200.*cm,0.,0.),
        "tubeP", tube_log, world_phys, false, 0);
G4double divided_tube_dPhi = tube_dPhi/6.;
G4VSolid* div_tube =
    new G4Tubs("div_tube", 20*cm, 50*cm, 30*cm,
        -divided_tube_dPhi/2., divided_tube_dPhi);
G4LogicalVolume* div_tube_log =
    new G4LogicalVolume(div_tube,Pb,"div_tubeL",0,0,0);
G4VPhysicalVolume* div_tube_phys =
    new G4PVReplica("div_tube_phys", div_tube_log,
        tube_log, kPhi, 6, divided_tube_dPhi);
```

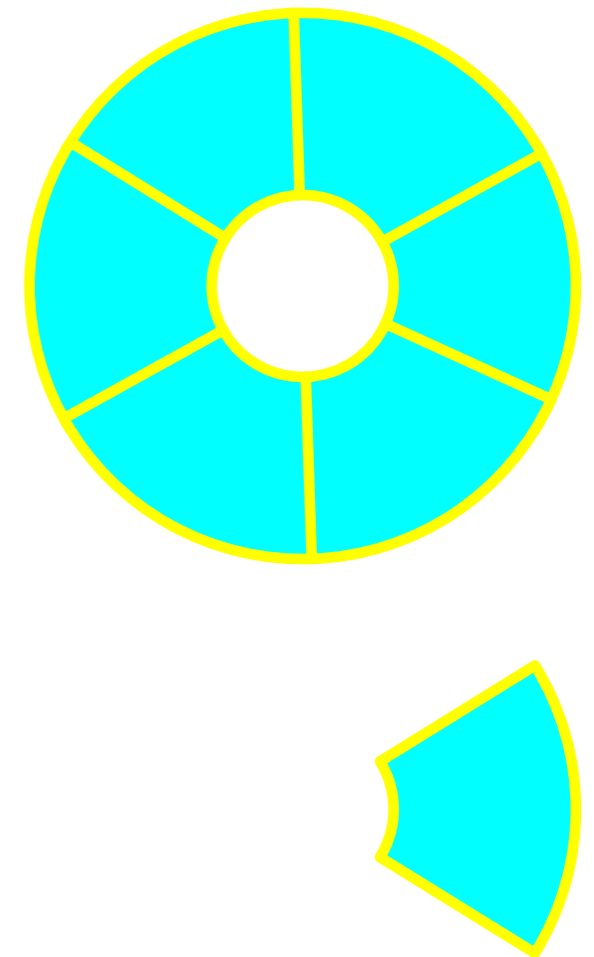

Divided Physical Volumes

- Implemented as “special” kind of parameterised volumes
 - Applies to CSG-like solids only (box, tubs, cons, para, trd, polycone, polyhedra)
 - Divides a volume in identical copies along one of its axis (copies are not strictly identical)
 - e.g. - a tube divided along its radial axis
 - Offsets can be specified
- The possible axes of division vary according to the supported solid type
- Represents many touchable detector elements differing only in their positioning
- **G4PVDivision** is the class defining the division
 - The parameterisation is calculated automatically using the values provided in input

Divided Volumes - 2

- **G4PVDivision** is a special kind of parameterised volume
 - The parameterisation is **automatically generated** according to the parameters given in **G4PVDivision**.
- Divided volumes are similar to replicas but ...
 - **Allowing for gaps in between** mother and daughter volumes
 - *Planning to allow also gaps between daughters and gaps on side walls*
- Shape of all daughter volumes must be **same shape as the mother volume**
 - Solid (to be assigned to the daughter logical volume) must be the same type, but different object.
- Replication must be aligned along one axis
- If no gaps in the geometry, **G4PVReplica** is recommended
 - For identical geometry, navigation in pure replicas is faster

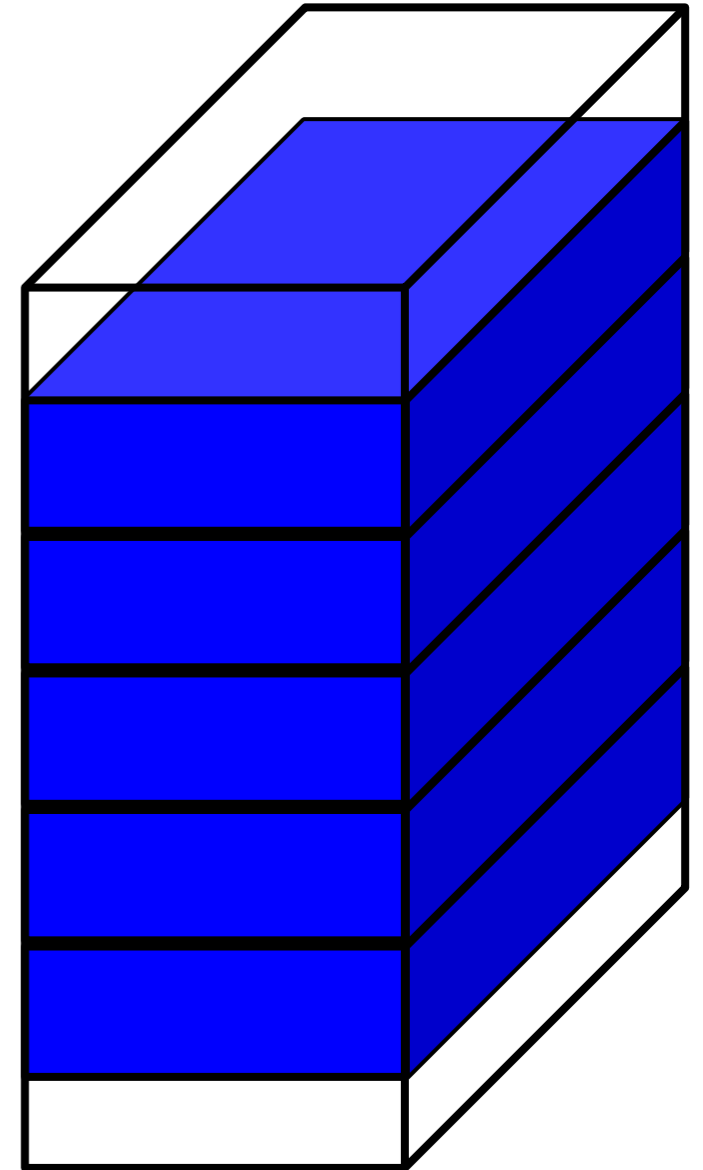

mother volume

Divided Volumes - 3

```
G4PVDivision(const G4String& pName,  
             G4LogicalVolume* pDaughterLogical,  
             G4LogicalVolume* pMotherLogical,  
             const EAxis pAxis,  
             const G4int nDivisions, // number of division is given  
             const G4double offset);
```

- The size (width) of the daughter volume is calculated as
 $(\text{size of mother} - \text{offset}) / \text{nDivisions}$

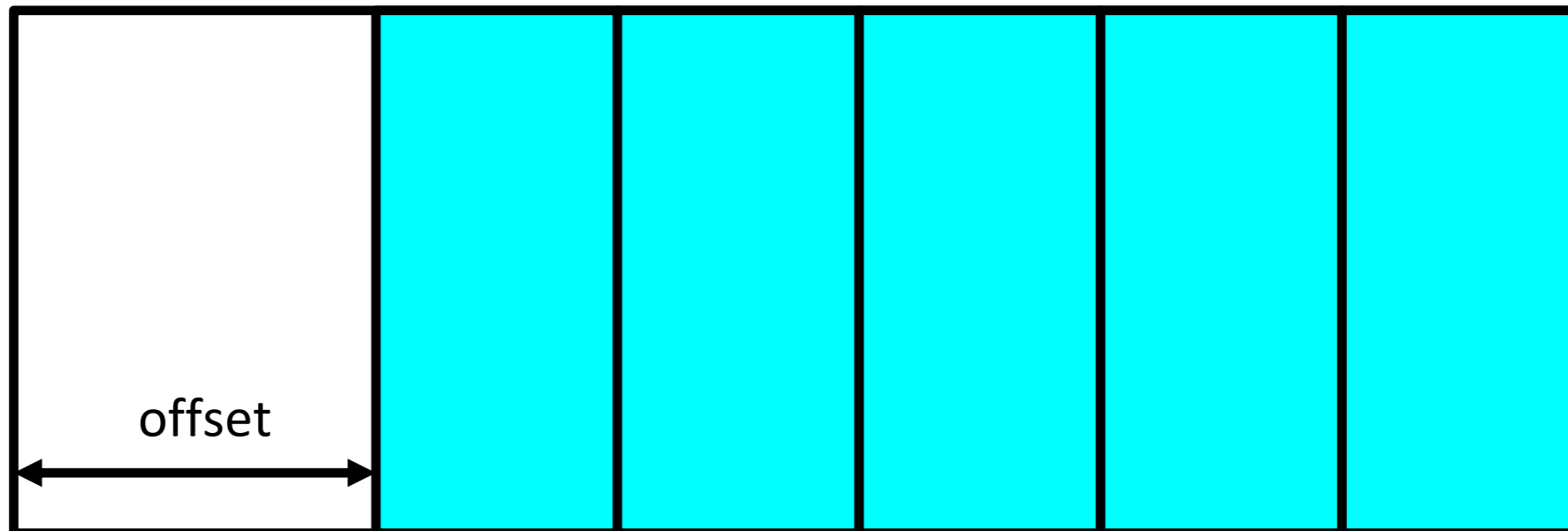

Divided Volumes - 4

```
G4PVDivision(const G4String& pName,  
             G4LogicalVolume* pDaughterLogical,  
             G4LogicalVolume* pMotherLogical,  
             const EAxis pAxis,  
             const G4double width, // width of daughter volume is given  
             const G4double offset);
```

- The number of daughter volumes is calculated as
 $\text{int}((\text{size of mother}) - \text{offset}) / \text{width}$
- As many daughters as width and offset allow

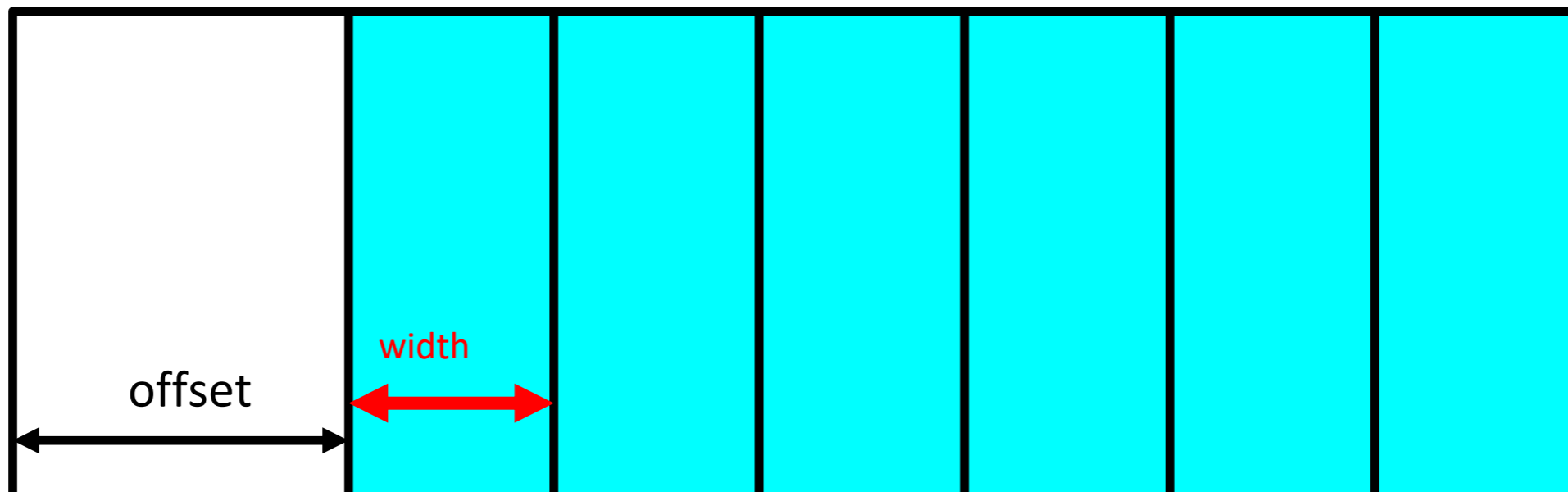

Divided Volumes - 5

```
G4PVDivision(const G4String& pName,  
             G4LogicalVolume* pDaughterLogical,  
             G4LogicalVolume* pMotherLogical,  
             const EAxis pAxis,  
             const G4int nDivisions, // both number of divisions  
             const G4double width, // and width are given  
             const G4double offset);
```

- *nDivisions* daughters of *width* thickness

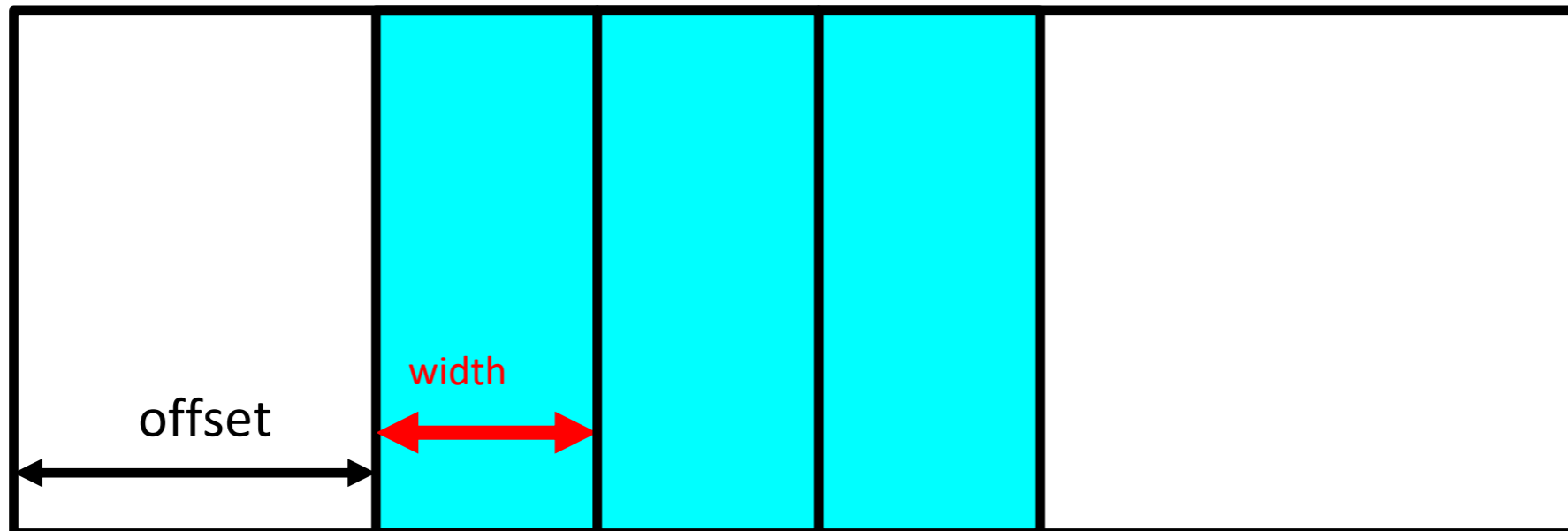

Divided Volumes - 6

- Divisions are allowed for the following shapes / axes:
 - **G4Box** : **kXAxis**, **kYAxis**, **kZAxis**
 - **G4Tubs** : **kRho**, **kPhi**, **kZAxis**
 - **G4Cons** : **kRho**, **kPhi**, **kZAxis**
 - **G4Trd** : **kXAxis**, **kYAxis**, **kZAxis**
 - **G4Para** : **kXAxis**, **kYAxis**, **kZAxis**
 - **G4Polycone** : **kRho**, **kPhi**, **kZAxis**
 - **G4Polyhedra** : **kRho**, **kPhi**, **kZAxis**
 - **kPhi** - the number of divisions has to be the same as solid sides, (i.e. **numSides**), the width will **not** be taken into account
- In the case of division along **kRho** of **G4Cons**, **G4Polycone**, **G4Polyhedra**, if width is provided, it is taken as the width at the **-Z** radius; the width at other radii will be scaled to this one

GDML

- *Importing and exporting detector descriptions*

GDML components

- GDML (Geometry Description Markup Language) is defined through XML Schema (XSD)
 - XSD = XML based alternative to Document Type Definition (DTD)
 - defines document structure and the list of legal elements
 - XSD are in XML -> they are extensible
- GDML can be written by hand or generated automatically in Geant4
 - 'GDML writer' allows exporting a GDML file
- GDML needs a “reader”, integrated in Geant4
 - 'GDML reader' imports and creates 'in-memory' the representation of the geometry description

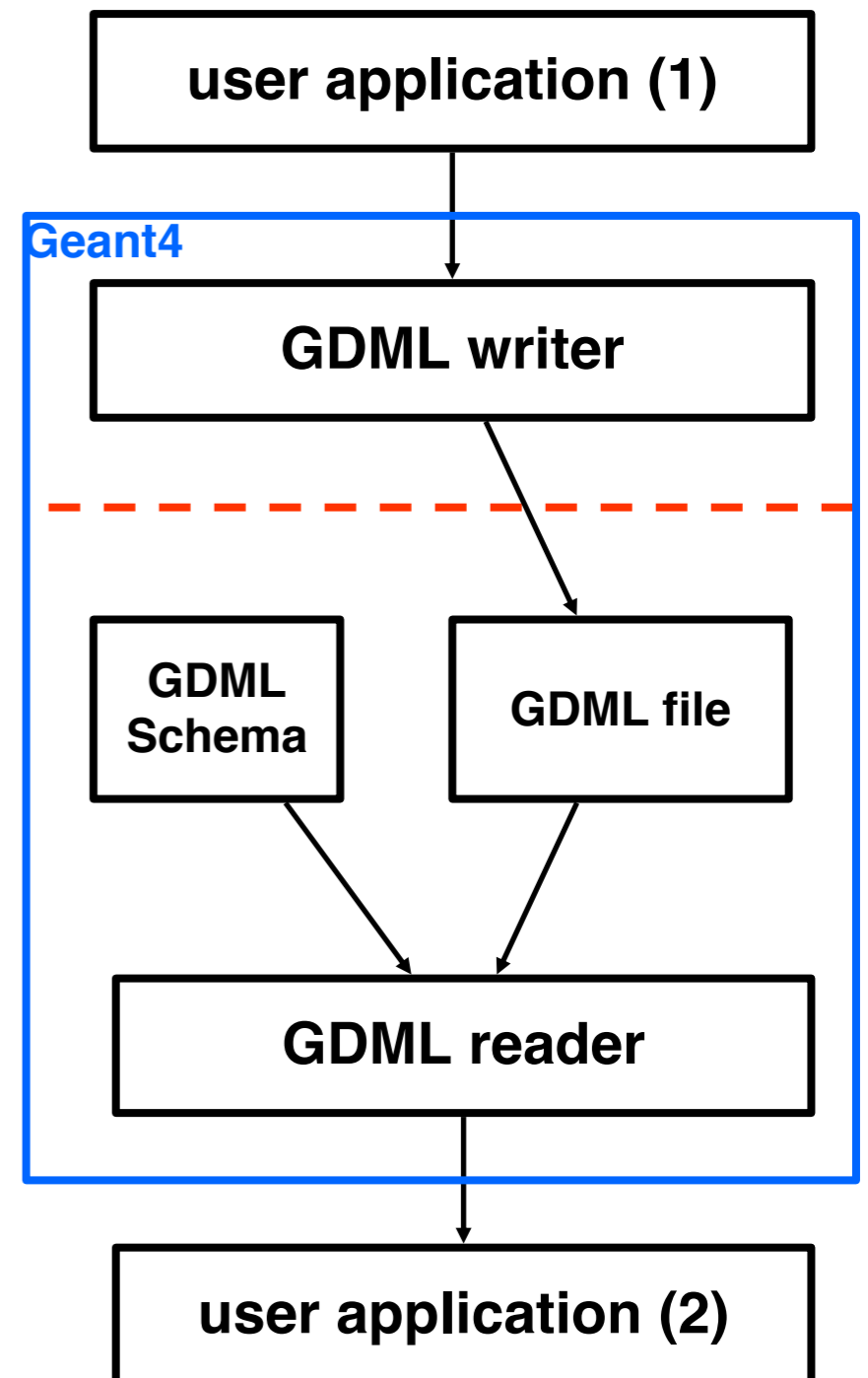

GDML Schema

- defines document structure and the list of legal elements
 - materials
 - material, isotope, element, mixture
 - solids
 - box, sphere, tube, cone, polycone, parallepiped, trapezoid, torus, polyhedra, hyperbolic tube, elliptical tube, ellipsoid
 - boolean solids
 - volumes
 - assembly volumes and reflections
 - replicas and divisions
 - parameterised volumes (position, rotation and size)
 - first implementation

GDML document

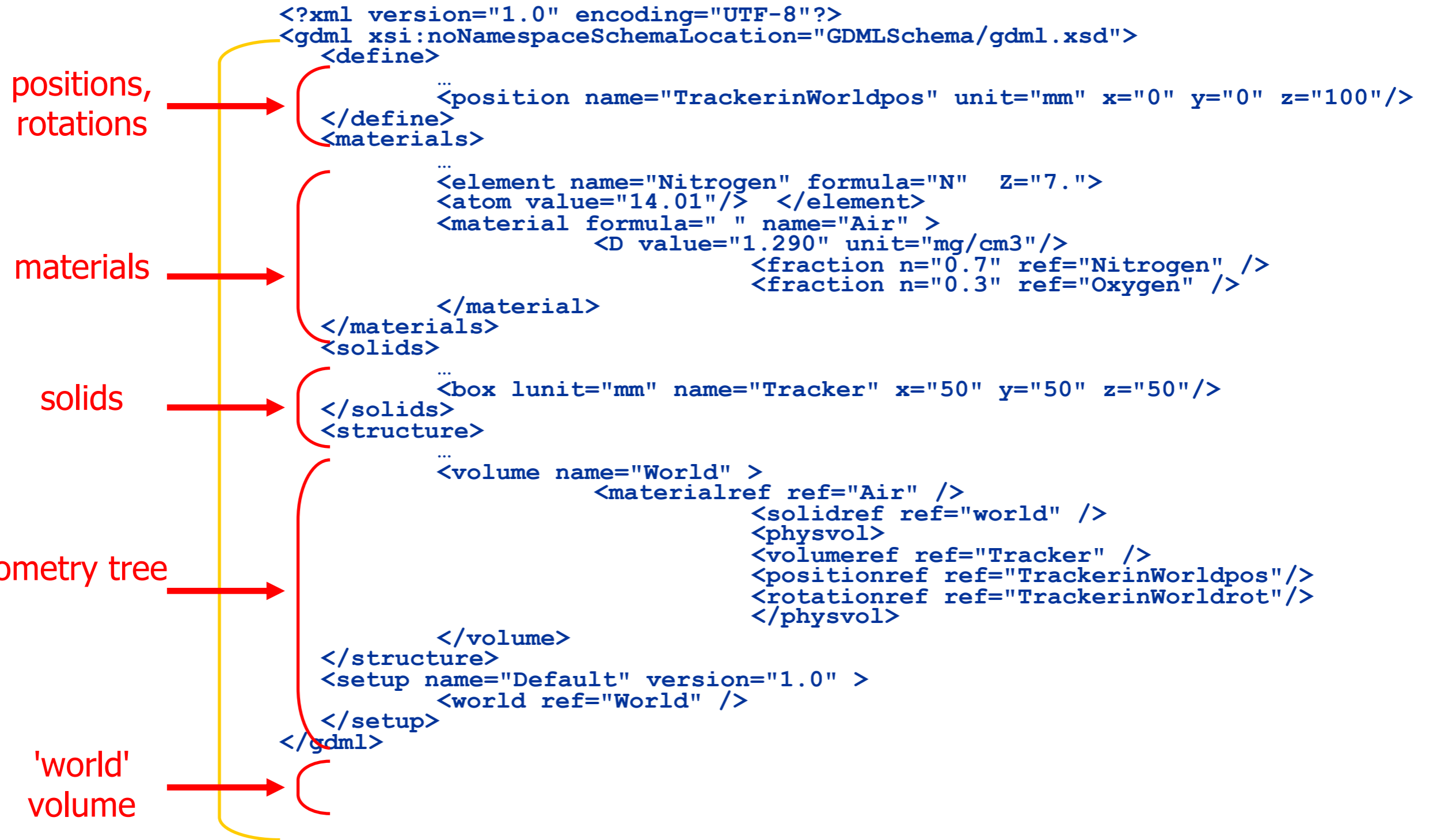

GDML – Geant4 binding

- XML schema available from <http://cern.ch/gdml>
 - Also available within Geant4 distribution
 - See in `geant4/source/persistency/gdml/schema/`
 - Latest schema release GDML_3_0_0 (as from 9.2 release)
- Requires XercesC++ XML parser
 - Available from: <http://xerces.apache.org/xerces-c>
 - Tested with versions 2.8.0 and 3.0.1
- Optional package to be linked against during build
 - `G4LIB_BUILD_GDML` and `XERCESCROOT` variables
 - Examples available: `geant4/examples/extended/persistency/gdml`

CMS detector through GDML

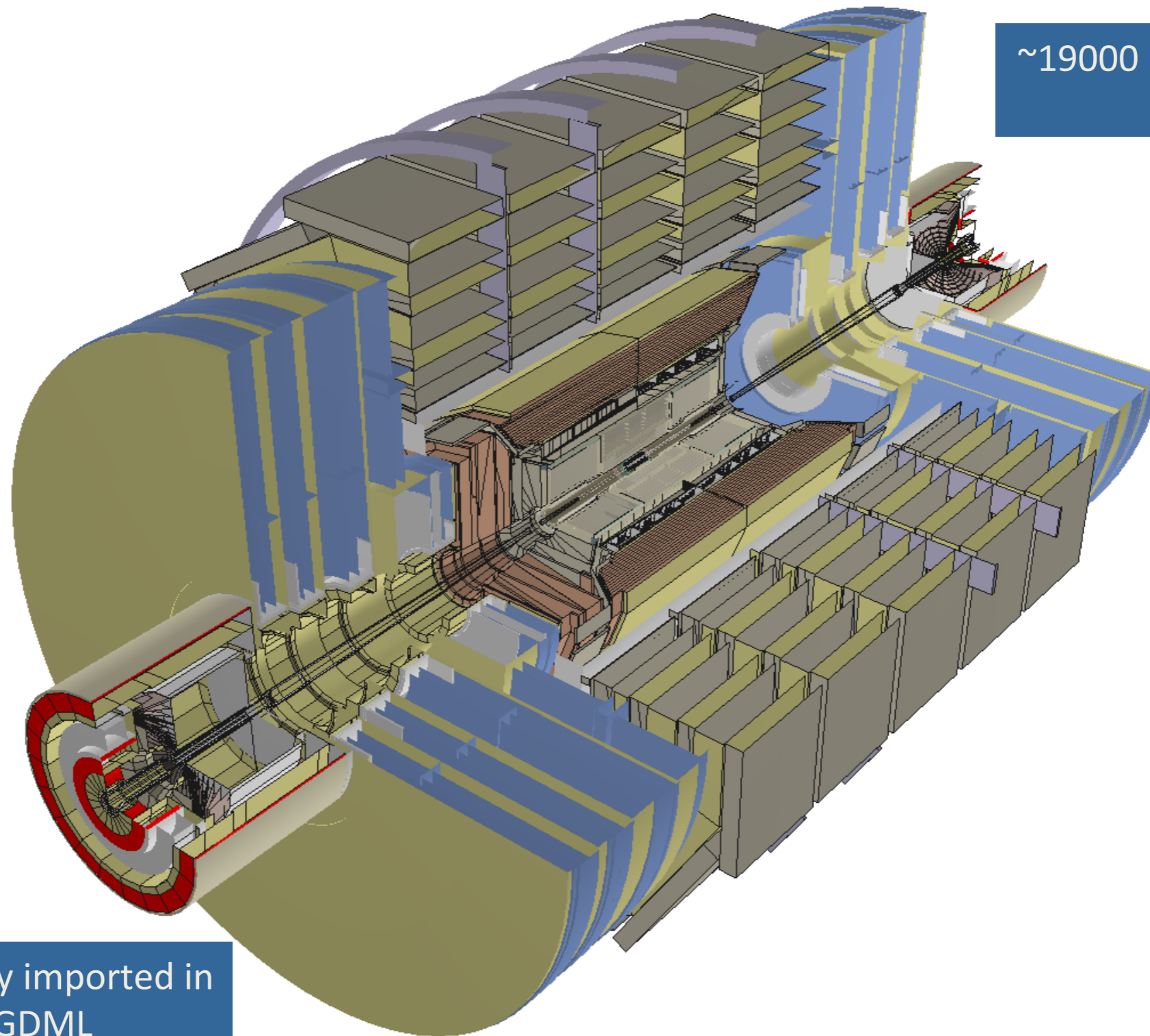

~19000 physical volumes

Geant4 CMS geometry imported in
Root through GDML

LHCb detector through GDML

~5000 physical volumes

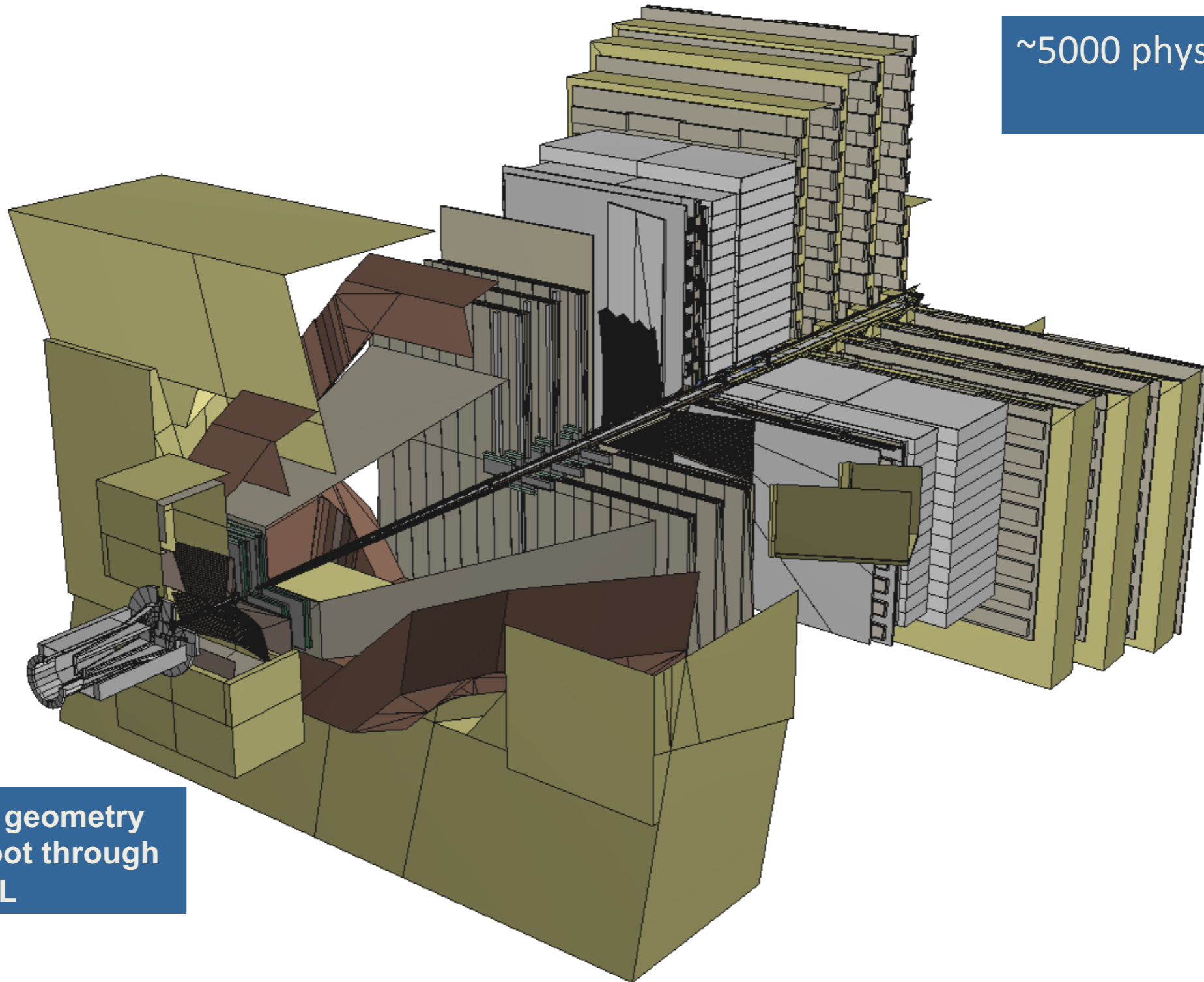

Geant4 LHCb geometry imported in Root through GDML

Using GDML in Geant4

to write:

```
#include "G4GDMLParser.hh"  
G4GDMLParser parser;  
parser.Write("g4test.gdml", pWorld, true, "path_to_schema/gdml.xsd");
```

instantiate GDML parser

Concatenate or not pointers to entity names

to read:

```
parser.Read("g4test.gdml", true);
```

pass the 'top' volume to the writer

Activate or de-activate schema validation

```
pWorld = GDMLProcessor::GetInstance()->GetWorldVolume();
```

get pointer to 'top' world volume

Using GDML in Geant4 - 2

- Any geometry tree can be dumped to file
 - ... just provide its physical volume pointer (**pVol**):
`parser.Write("g4test.gdml", pVol);`
- A geometry setup can be split in modules
 - ... starting from a geometry tree specified by a physical volume:
`parser.AddModule(pVol);`
 - ... indicating the depth from which starting to modularize:
`parser.AddModule(depth);`
- Provides facility for importing CAD geometries generated through STEP-Tools
- Allows for easy extensions of the GDML schema and treatment of auxiliary information associated to volumes
- Full coverage of materials, solids, volumes and simple language constructs (variables, loops, etc...)

Importing CAD geometries with GDML

- CAD geometries generated through STEP-Tools (`stFile.geom`, `stFile.tree` files) can be imported through the GDML reader:

- `parser.ParseST("stFile", WorldMaterial, GeomMaterial);`

- Example provided in `examples/extended/persistence/gdml/G02`

- To

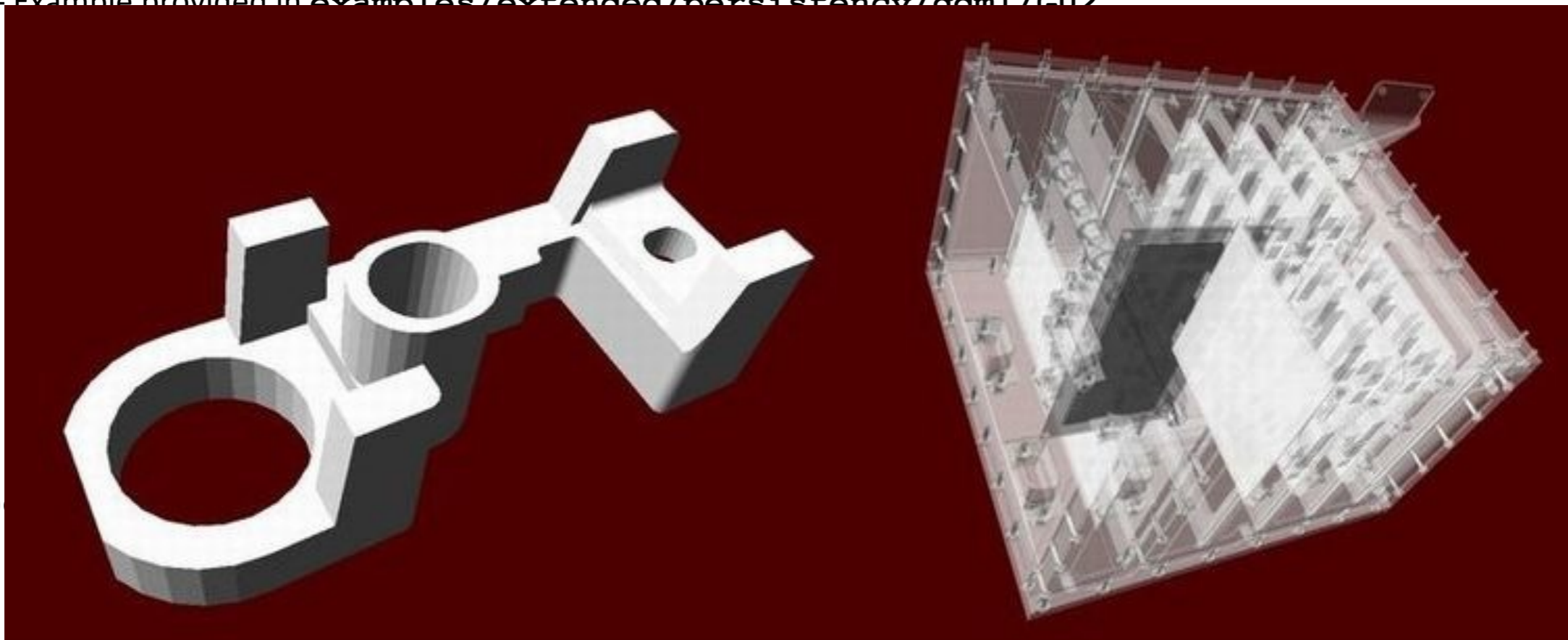

GDML processing performance

- GDML reader/writer tested on
 - complete LHCb and CMS geometries
 - parts of ATLAS geometry
 - full ATLAS geometry includes custom solids
- for LHCb geometry (~5000 physical volumes)
 - writing out ~10 seconds (on P4 2.4GHz)
 - reading in ~ 5 seconds
 - file size ~2.7 Mb (~40k lines)
- for CMS geometry (~19000 physical volumes)
 - writing out ~30 seconds
 - reading in ~15 seconds
 - file size ~7.9 Mb (~120k lines)

GDML as primary geometry source

- Linear Collider
 - Linear Collider Detector Description (LCDD) extends GDML with Geant4-specific information (sensitive detectors, physics cuts, etc)
 - GDML/LCDD is generic and flexible
 - several different full detector design concepts, including SiD, GLD, and LDC, where simulated using the same application

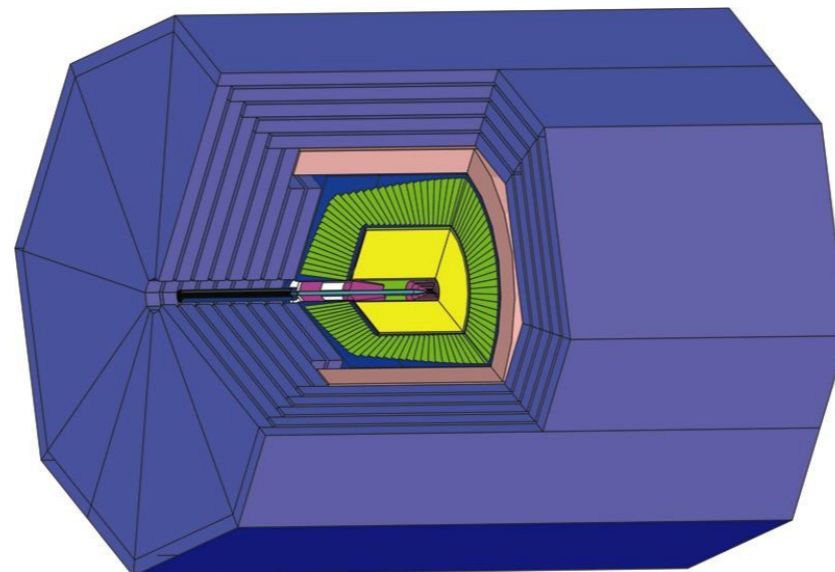
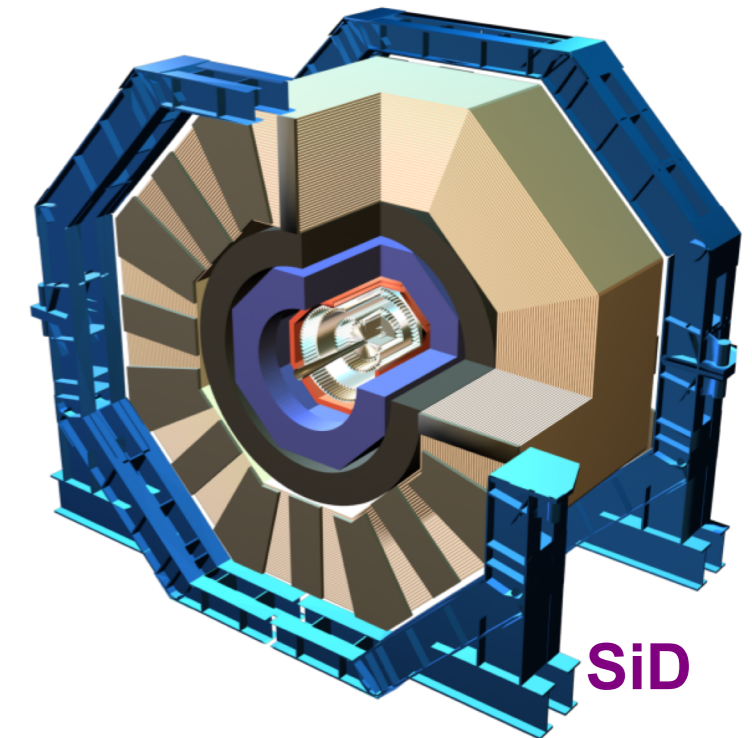

GLD

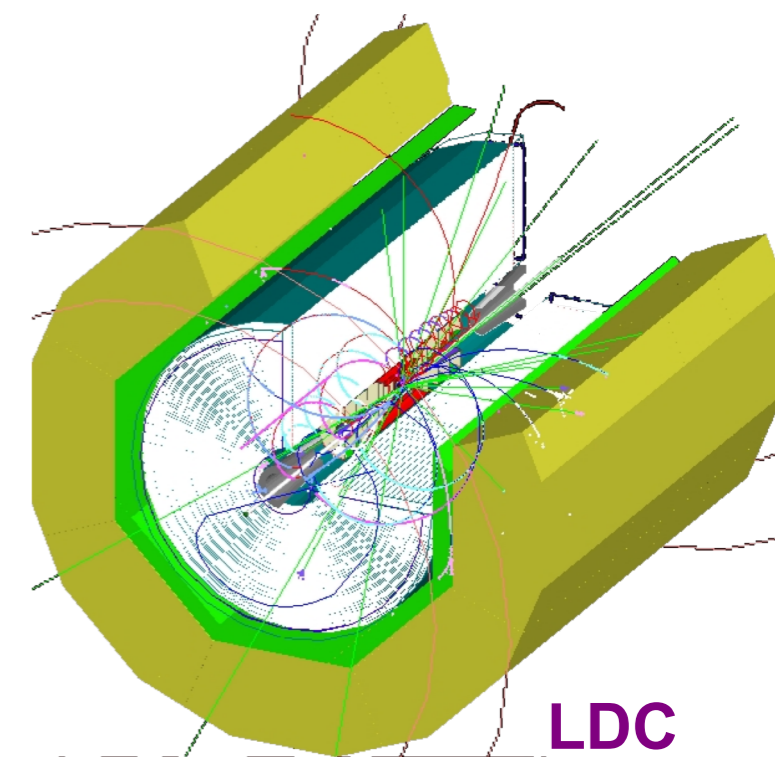

LDC

GDML as primary geometry source - 2

- Space Research @ ESA
 - Geant4 geometry models
 - component degradation studies (JWST, ConeXpress,...)
 - GRAS (Geant4 Radiation Analysis for Space)
 - enables flexible geometry configuration and changes
 - main candidate for CAD to Geant4 exchange format

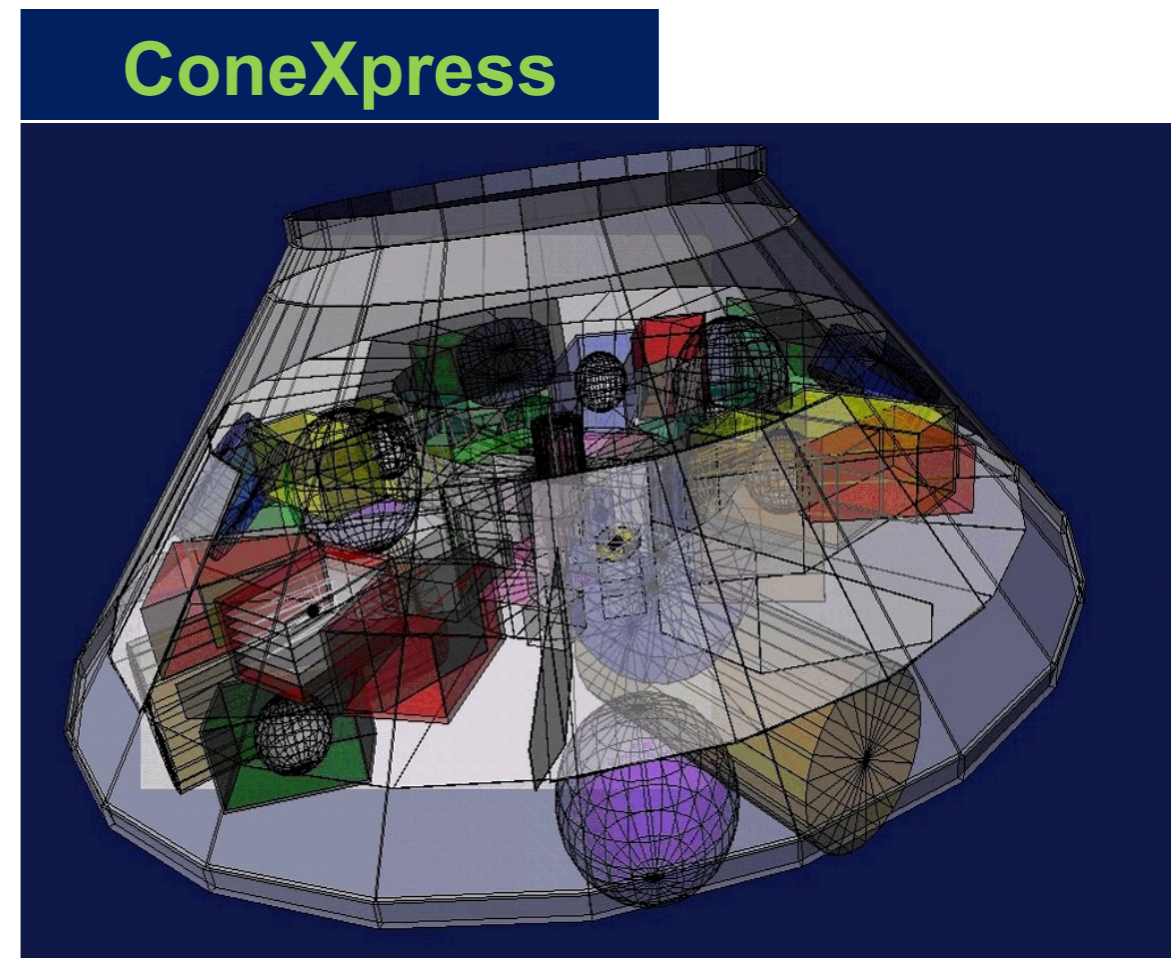

GDML as primary geometry source - 3

- Anthropomorphic Phantom
 - Modeling of the human body and anatomy for radioprotection studies
 - no hard-coded geometry, flexible configuration

