

Three-body dynamics of the $a_1(1260)$ resonance from lattice QCD

2107.03973 [hep-lat]

Maxim Mai, A. Alexandru, R. Brett, C. Culver,

M. Döring, F. Lee, D. Sadasivan

[GWQCD]

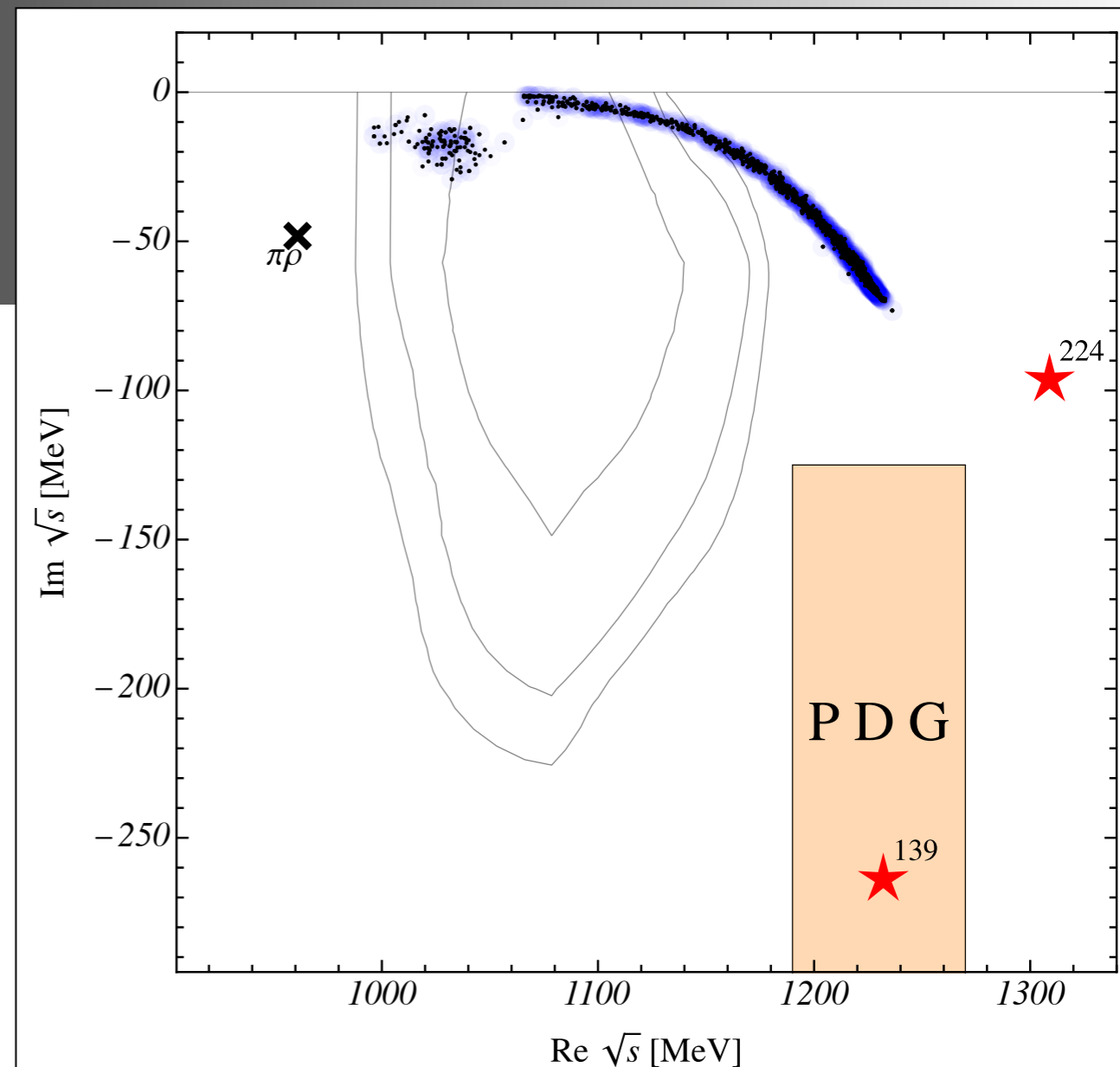

DE-SC0016582
DE-FG02-95ER40907



PHY-2012289

Deutsche
Forschungsgemeinschaft

DFG

MA-7156

Pattern and production mechanisms of many excited hadrons are unresolved issues

Many questions are related to the hadronic 3-body problem

- Roper resonance $N^*(1440)$
- exotic mesons: $\pi_1(1600)$, ...
- $\omega(782)$, $a_1(1260)$, ...

experimental searches
@COMPASS, GlueX

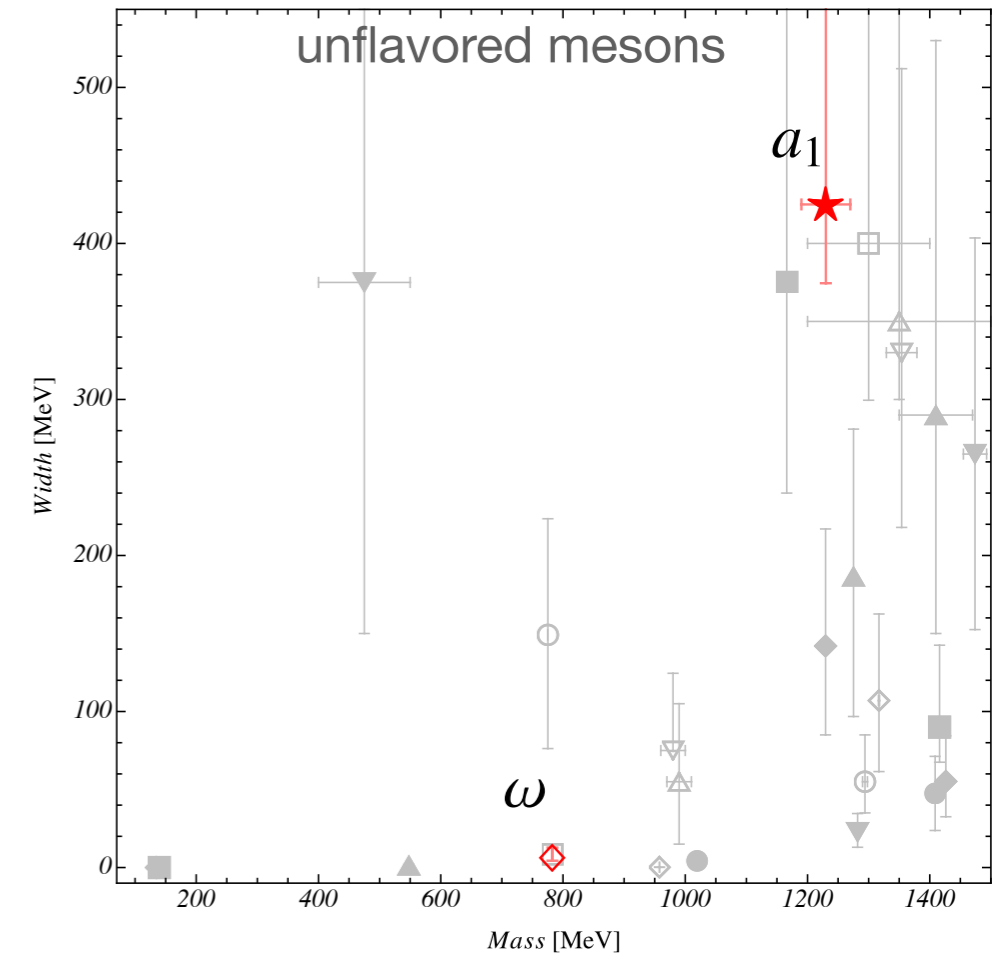

Pattern and production mechanisms of many excited hadrons are unresolved issues

Many questions are related to the hadronic 3-body problem

- Roper resonance $N^*(1440)$
- exotic mesons: $\pi_1(1600)$, ...
- $\omega(782)$, $a_1(1260)$, ...

experimental searches
@COMPASS, GlueX

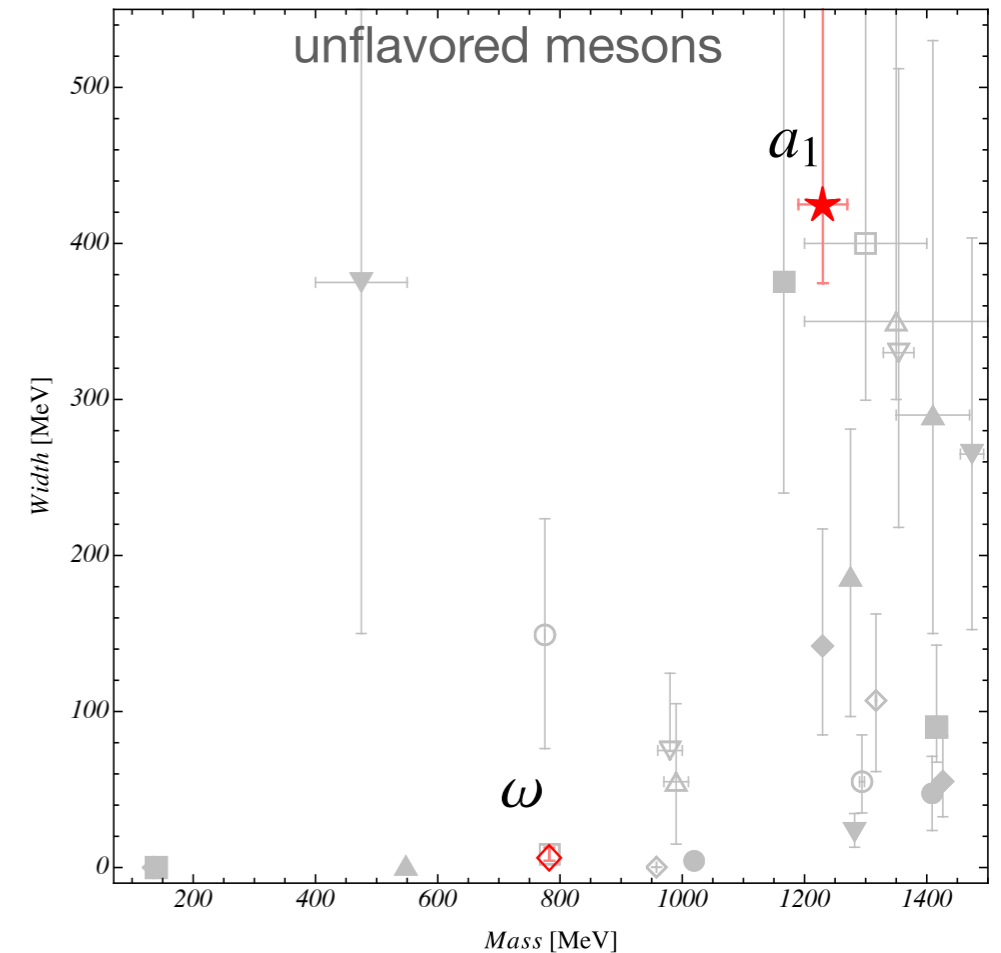

This work: $a_1(1260)$ from lattice QCD

- Goal #1: Resonant three-body system in lattice QCD.
- Goal #2: First-ever determination of parameters of three-body resonance from QCD.

Universal parameters of resonances from poles on Riemann surface

- 3-step procedure:

Universal parameters of resonances from poles on Riemann surface

- 3-step procedure:

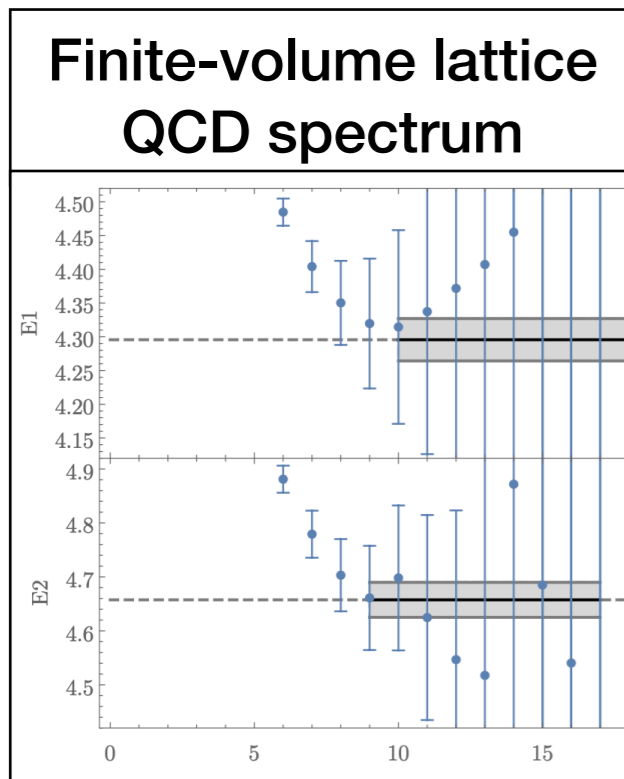

Universal parameters of resonances from poles on Riemann surface

- 3-step procedure:

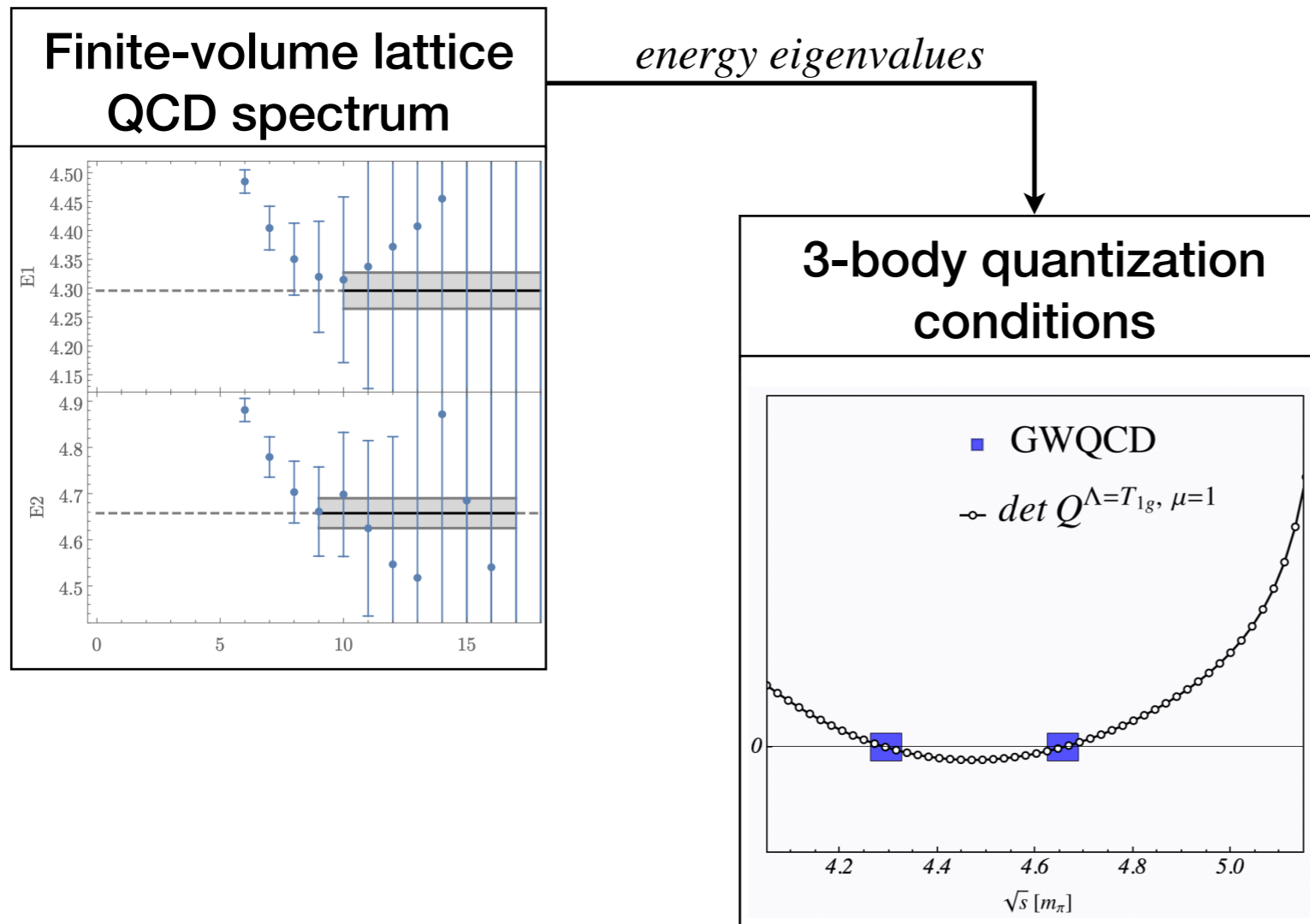

Universal parameters of resonances from poles on Riemann surface

- 3-step procedure:

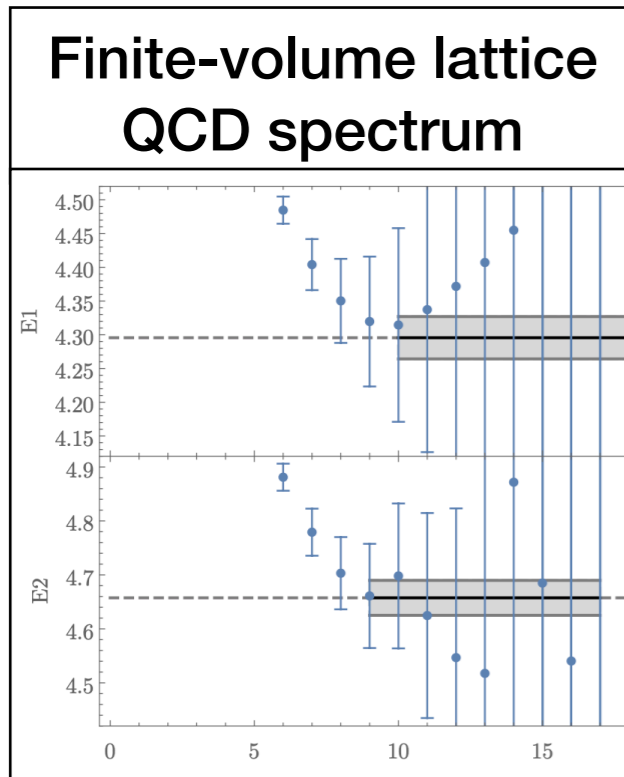

energy eigenvalues

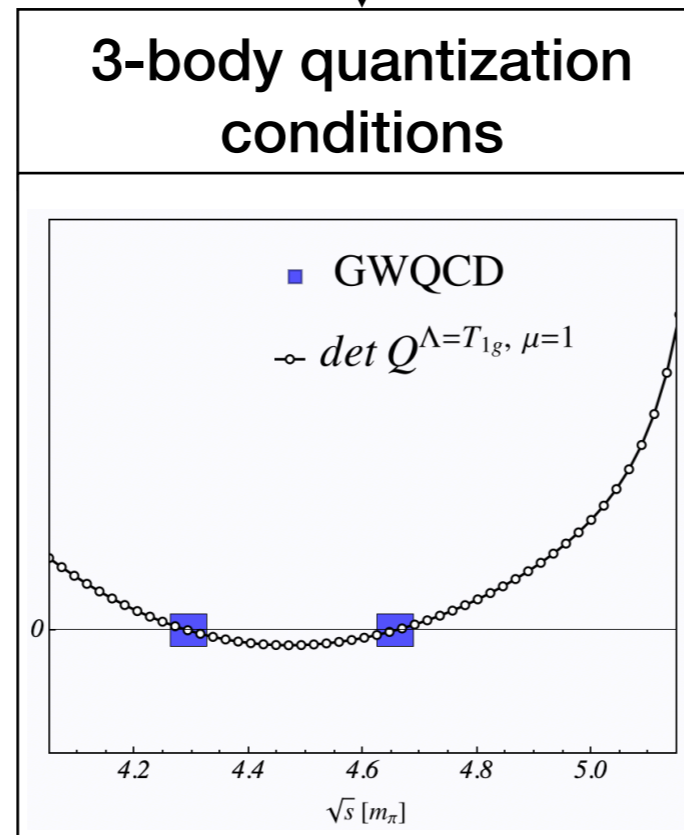

volume-independent quantities

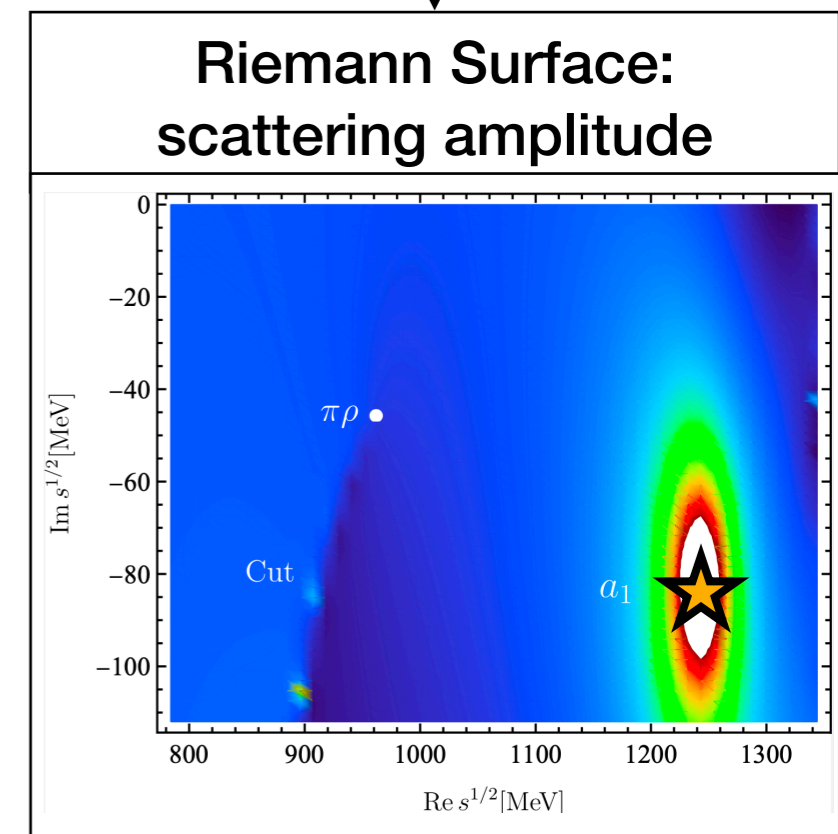

Phenomenological studies

- A clean way: $a_1(1260)$ from τ -decays (ALEPH@CERN)

Mikhashenko et al. [JPAC] (2018) Sadasivan/MM/Döring(2020)

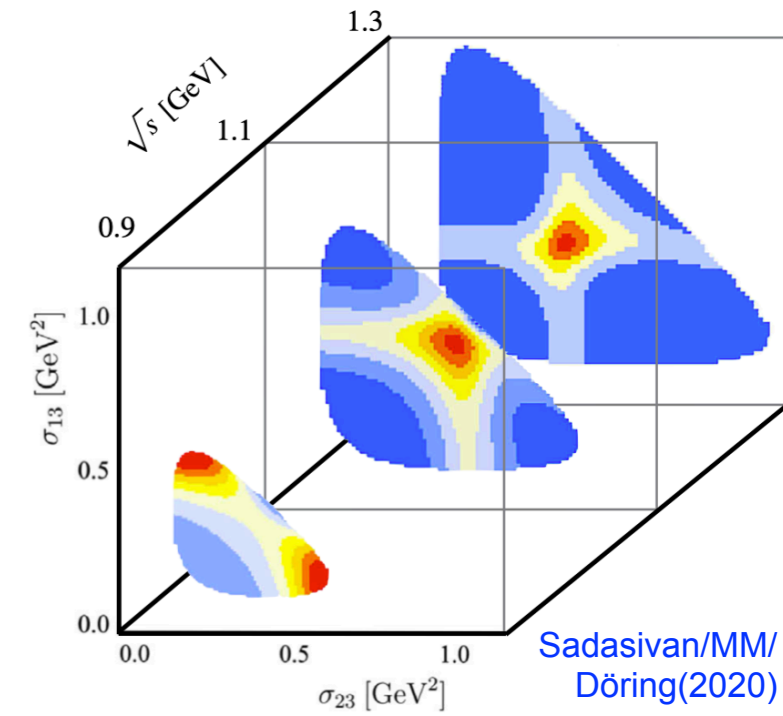

Phenomenological studies

- A clean way: $a_1(1260)$ from τ -decays (ALEPH@CERN)

Mikhasenko et al. [JPAC] (2018) Sadasivan/MM/Döring(2020)

Theoretical ab-initio access: lattice QCD

- full quark-gluon dynamics with some technical issues

1. Discretized Euclidean space-time >> continuum limit
2. Unphysical pion mass >> chiral extrapolations
3. Finite Volume >> quantization condition

- many studies of 2-body systems

[NPLQCD], [RQCD], [ETMC], [HadSpec], ... **Review: Rev.Mod.Phys. 90 (2018) 2**

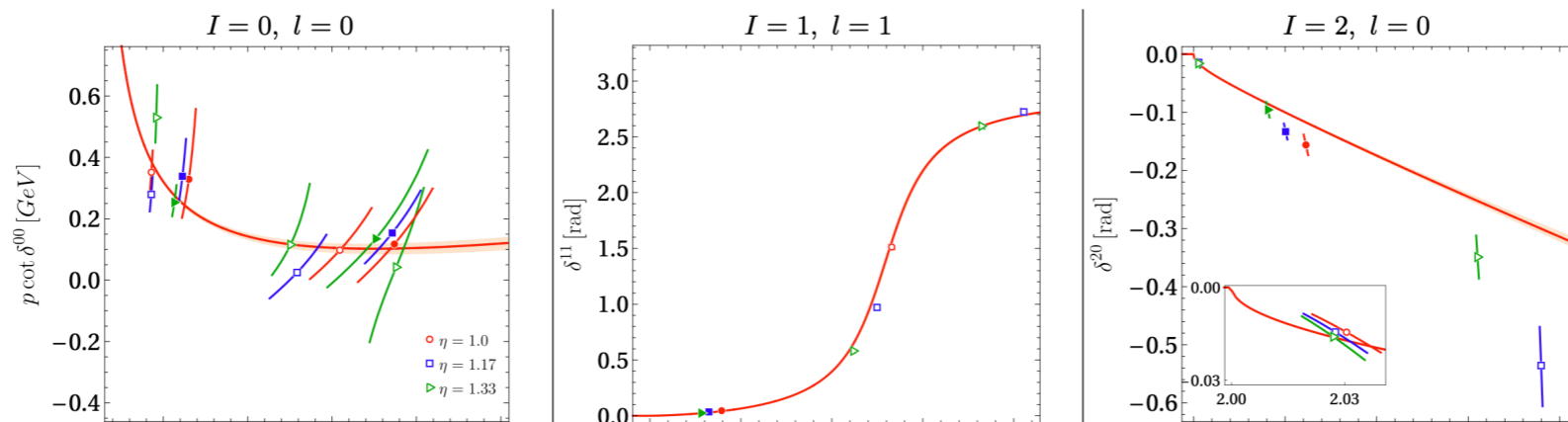

e.g. MM et al. [GWQCD] (2019)

- new calculations of non-resonant 3-body systems with maximal isospin: $\pi^+\pi^+\pi^+$, $K^-K^-K^-$, ...

[NPLQCD]; Hörz/Hanlon; [GWQCD]; [HadSpec]; Blanton et al.

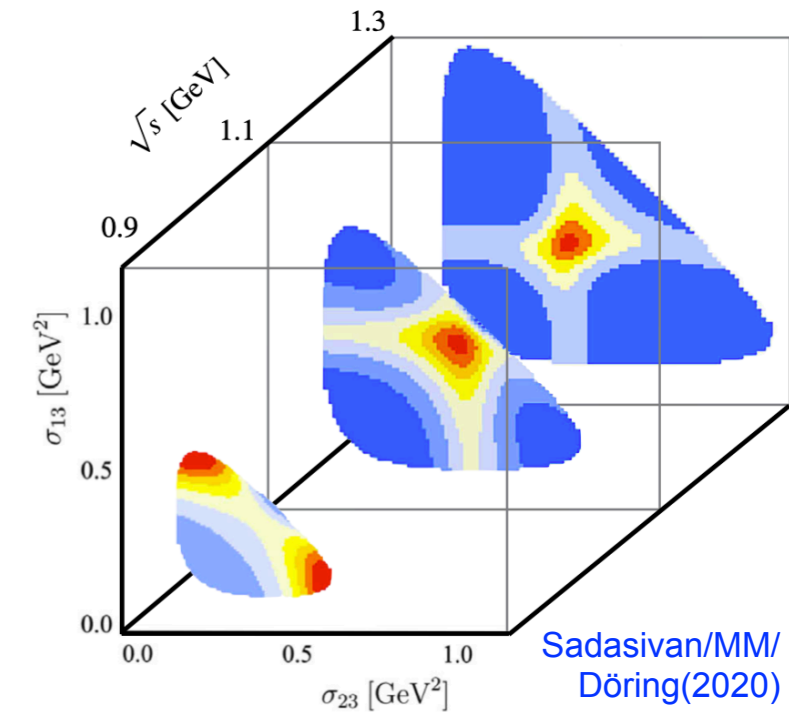

Key details of GWQCD lattice QCD calculation

- $N_f = 2$ dynamical fermions, LapH smearing
- $\mathbf{P}=(0,0,0)$, $m_\pi=224$ MeV, $m_\pi L=3.3$
- GEVP with one-/two-/three-meson operators
- Relevant irrep(O_h) for $\mathbf{a}_1(1260)$ $I^G (J^P C) = 1^- (1^{++})$:

Alexandru, Brett, Culver, Guo, Lee, Pelissier (2013-2021)
PRD87,PRD94,PRD98,PRD96,PRL117,PRD100

\mathbf{P}	Λ	$J^P (I^G = 1^-)$
$\mathbf{P} = (0, 0, 0)$	T_{1g}	$1^+, 3^+, \dots$
	A_{1u}	$0^-, 4^-, \dots$

Key details of GWQCD lattice QCD calculation

- $N_f = 2$ dynamical fermions, LapH smearing
- $\mathbf{P}=(0,0,0)$, $m_\pi=224$ MeV, $m_\pi L=3.3$
- GEVP with one-/two-/three-meson operators
- Relevant irrep(O_h) for $a_1(1260)$ $I^G (J^P C) = 1^- (1^{++})$:

Alexandru, Brett, Culver, Guo, Lee, Pelissier (2013-2021)
PRD87,PRD94,PRD98,PRD96,PRL117,PRD100

\mathbf{P}	Λ	$J^P (I^G = 1^-)$
$\mathbf{P} = (0, 0, 0)$	T_{1g}	$1^+, 3^+, \dots$
	A_{1u}	$0^-, 4^-, \dots$

Key results:

- 3π operators essential for the excited-state extraction
c.f. $\rho\pi$ operators in previous 2-meson a_1 calculation

Lang et al. JHEP 04, 162 (2014)

- high-momentum states are required:
 $\pi(0,0,0)\pi(+1,+1,0)\pi(-1,-1,0)$ etc..

- two levels exist below 5π threshold

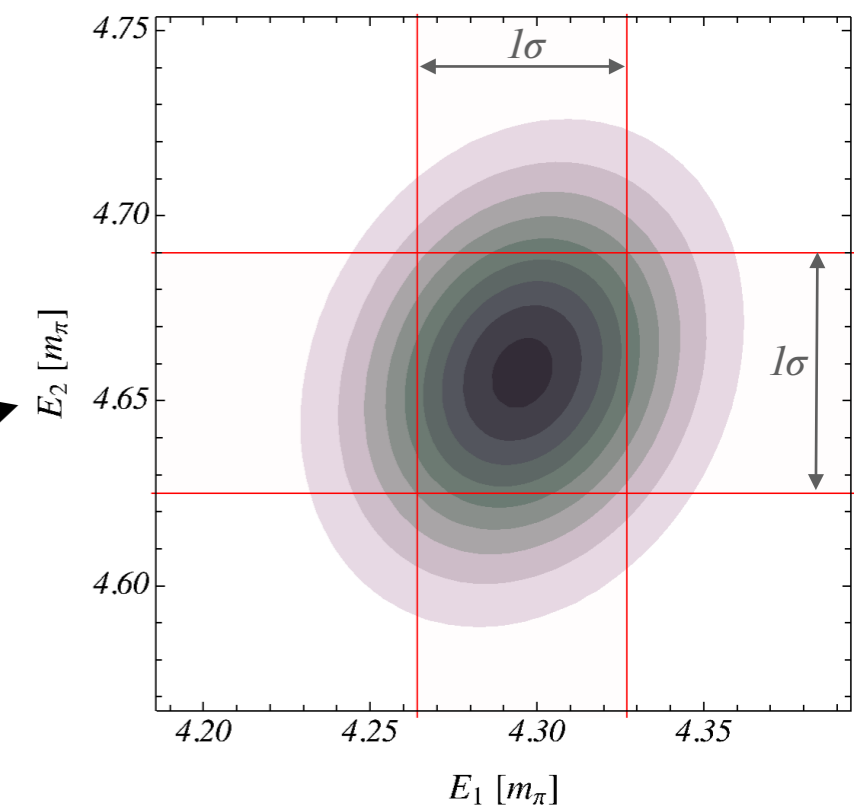

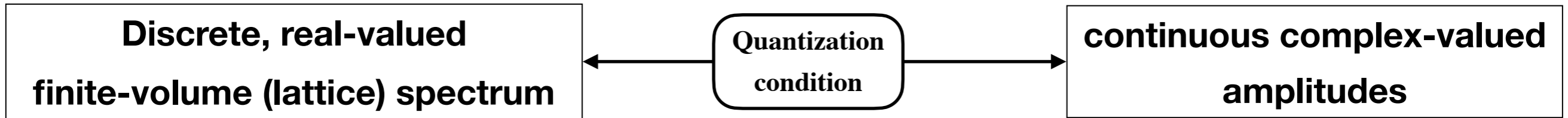

- established in 2-body: Lüscher's method, extensions... [Lüscher, Gottlieb, Rummukainen, Feng, Li, Liu, Döring, Briceño, Bernard, Meißner, Rusetsky...](#)

- 3-body methods matured [Bedaque, Blanton, Briceño, Davoudi, Döring, Grieshammer, Guo, Hammer, Hansen, MM, Meißner, Müller, Pang, Polejaeva, Romero-López, Rusetsky, Sharpe, Wu](#)

Reviews: Hansen/Sharpe(2019) MM/Döring/Rusetsky(2021)

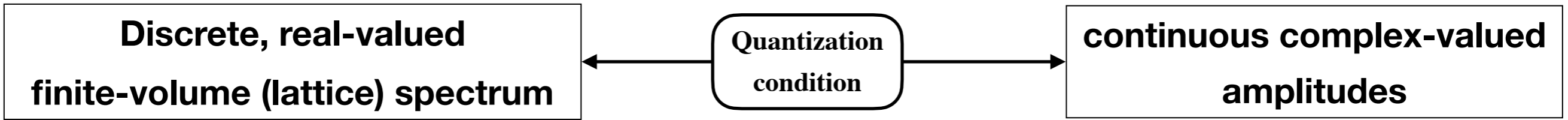

- established in 2-body: Lüscher's method, extensions... [Lüscher, Gottlieb, Rummukainen, Feng, Li, Liu, Döring, Briceño, Bernard, Meißner, Rusetsky..](#)

- 3-body methods matured [Bedaque, Blanton, Briceño, Davoudi, Döring, Grißhammer, Guo, Hammer, Hansen, MM, Meißner, Müller, Pang, Polejaeva, Romero-López, Rusetsky, Sharpe, Wu](#)

Reviews: Hansen/Sharpe(2019) MM/Döring/Rusetsky(2021)

Finite Volume Unitarity (FVU) [MM, Döring EPJA \(2017\) PRL \(2019\)](#)

- extended to higher spin and coupled-channels: new degree of freedom (helicity, λ)

$$0 = \det \left[B(s) + C(s) - 2L^3 E_{\mathbf{p}} \left(\tilde{K}_2^{-1}(s) - \Sigma_2^L(s) \right) \right]_{(\lambda'\lambda)(\mathbf{p}'\mathbf{p})}^{\Lambda}$$

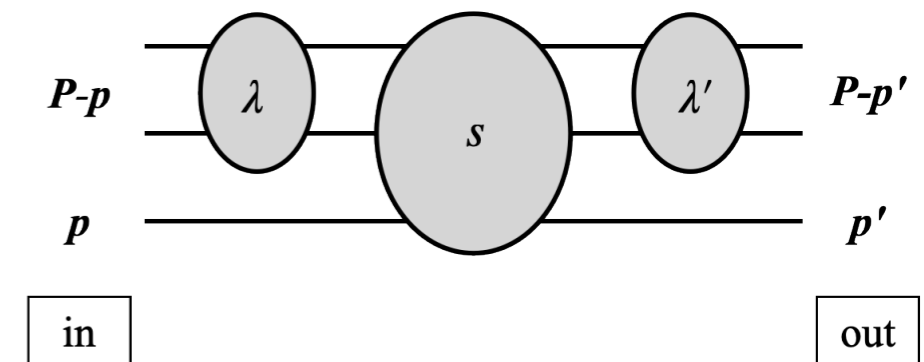

- ∞ -dim. determinant equation in $\mathbf{p} \in \frac{2\pi}{L} \mathbf{Z}^3 \rightarrow$ practical applications require truncation
- \rightarrow common to all quantization conditions

$$0 = \det \left[B(s) + C(s) - 2L^3 E_{\mathbf{p}} \left(\tilde{K}_2^{-1}(s) - \Sigma_2^L(s) \right) \right]_{(\lambda'\lambda)(\mathbf{p}'\mathbf{p})}^{\Lambda}$$

MM, Döring EPJA (2017)
PRL (2019)

$$0 = \det \left[B(s) + C(s) - 2L^3 E_{\mathbf{p}} \left(\tilde{K}_2^{-1}(s) - \Sigma_2^L(s) \right) \right]_{(\lambda'\lambda)(\mathbf{p}'\mathbf{p})}^{\Lambda}$$

MM, Döring EPJA (2017)
PRL (2019)

one-particle exchange

- fixed by 3b-unitarity

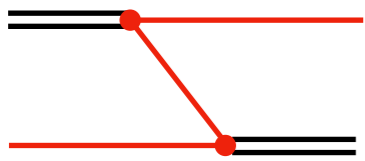

- no free parameters

two-body self-energy

- fixed by 2b-unitarity

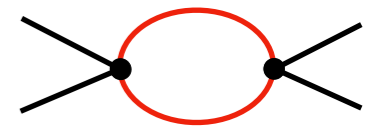

- no free parameters

$$0 = \det \left[B(s) + C(s) - 2L^3 E_p \left(\tilde{K}_2^{-1}(s) - \Sigma_2^L(s) \right) \right]_{(\lambda'\lambda)(\mathbf{p}'\mathbf{p})}^\Lambda$$

MM, Döring EPJA (2017)
PRL (2019)

one-particle exchange

- fixed by 3b-unitarity

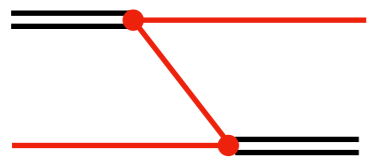

- no free parameters

two-body kernel

- dynamics of $l=1$ $\pi\pi$ system

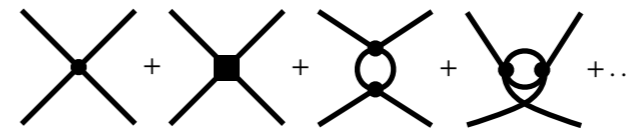

$$\tilde{K}_n^{-1}(s) = \sum_{i=0}^{n-1} a_i \cdot \sigma_p^i$$

- regular function \Rightarrow polynomial

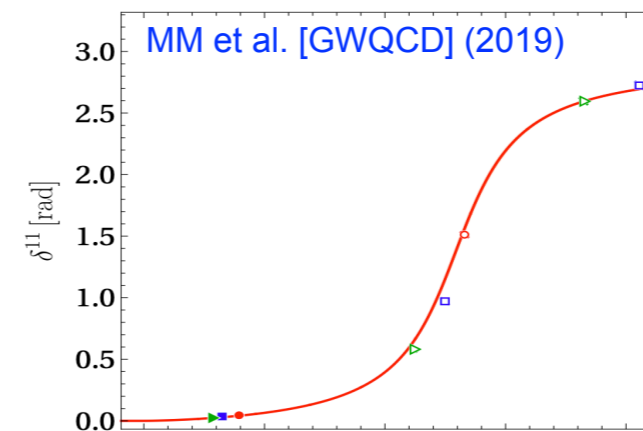

- parameters (a_0, a_1) from cross-channel fit to $\pi\pi$ GWQCD levels

two-body self-energy

- fixed by 2b-unitarity

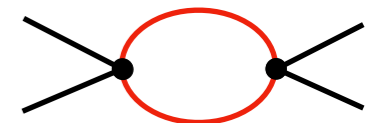

- no free parameters

$$0 = \det \left[B(s) + C(s) - 2L^3 E_{\mathbf{p}} \left(\tilde{K}_2^{-1}(s) - \Sigma_2^L(s) \right) \right]_{(\lambda'\lambda)(\mathbf{p}'\mathbf{p})}^{\Lambda}$$

MM, Döring EPJA (2017)
PRL (2019)

one-particle exchange

- fixed by 3b-unitarity

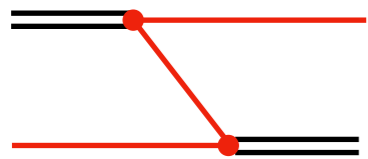

- no free parameters

three-body force

- dynamics of $\rho\pi$ system

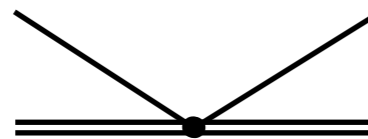

- regular function \Rightarrow Laurent series

$$C_{\ell'\ell}(s, \mathbf{p}', \mathbf{p}) = \sum_{i=-1}^{\infty} c_{\ell'\ell}^{(i)}(\mathbf{p}', \mathbf{p})(s - \mathbf{m}_{a_1}^2)^i$$

- fit to 3-body levels \rightarrow next slide

two-body kernel

- dynamics of $l=1$ $\pi\pi$ system

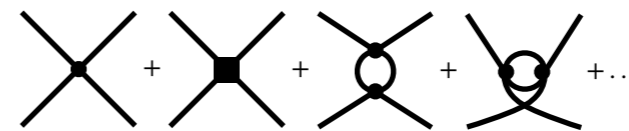

$$\tilde{K}_n^{-1}(s) = \sum_{i=0}^{n-1} a_i \cdot \sigma_p^i$$

- regular function \Rightarrow polynomial

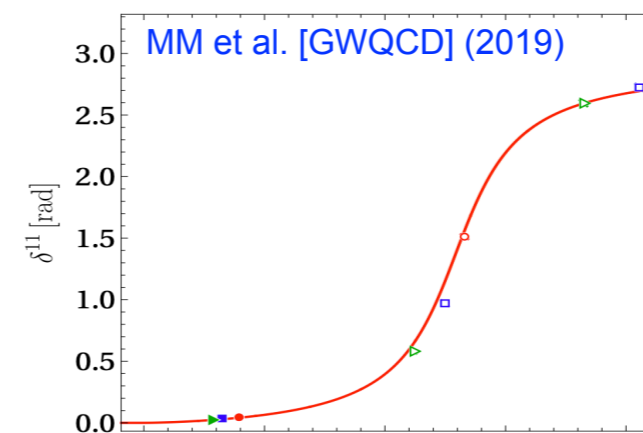

- parameters (a_0, a_1) from cross-channel fit to $\pi\pi$ GWQCD levels

two-body self-energy

- fixed by 2b-unitarity

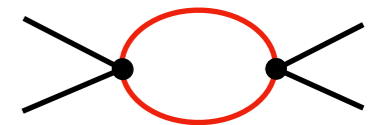

- no free parameters

Last unknown (volume-independent) quantity: 3-body term C

- a_1 pole is generated with/without explicit pole-term
- best description (with large correlations)

$$C_{\ell'\ell} = g_{\ell'} |\mathbf{p}'|^{\ell'} \frac{1}{s - \mathbf{m}_{a_1}^2} g_{\ell} |\mathbf{p}|^{\ell} + \mathbf{c} \delta_{\ell'0} \delta_{\ell 0}$$

- full resampling... accessing statistical errors

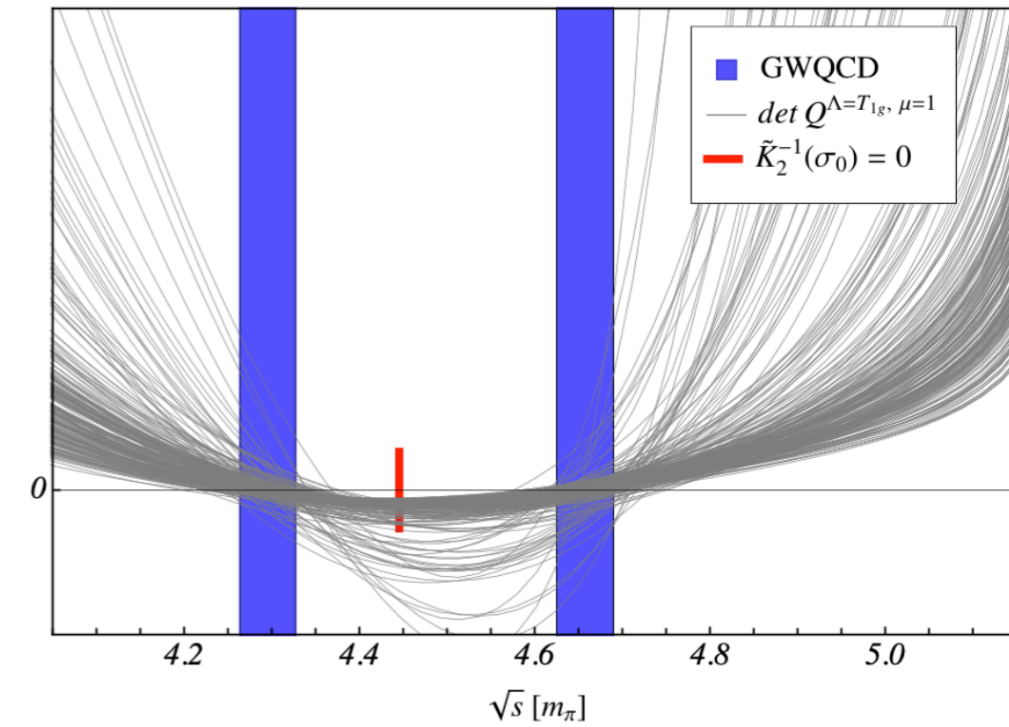

Last unknown (volume-independent) quantity: 3-body term C

- a_1 pole is generated with/without explicit pole-term
- best description (with large correlations)

$$C_{\ell'\ell} = g_{\ell'} |\mathbf{p}'|^{\ell'} \frac{1}{s - m_{a_1}^2} g_{\ell} |\mathbf{p}|^{\ell} + c \delta_{\ell'\ell} \delta_{\ell 0}$$

- full resampling... accessing statistical errors

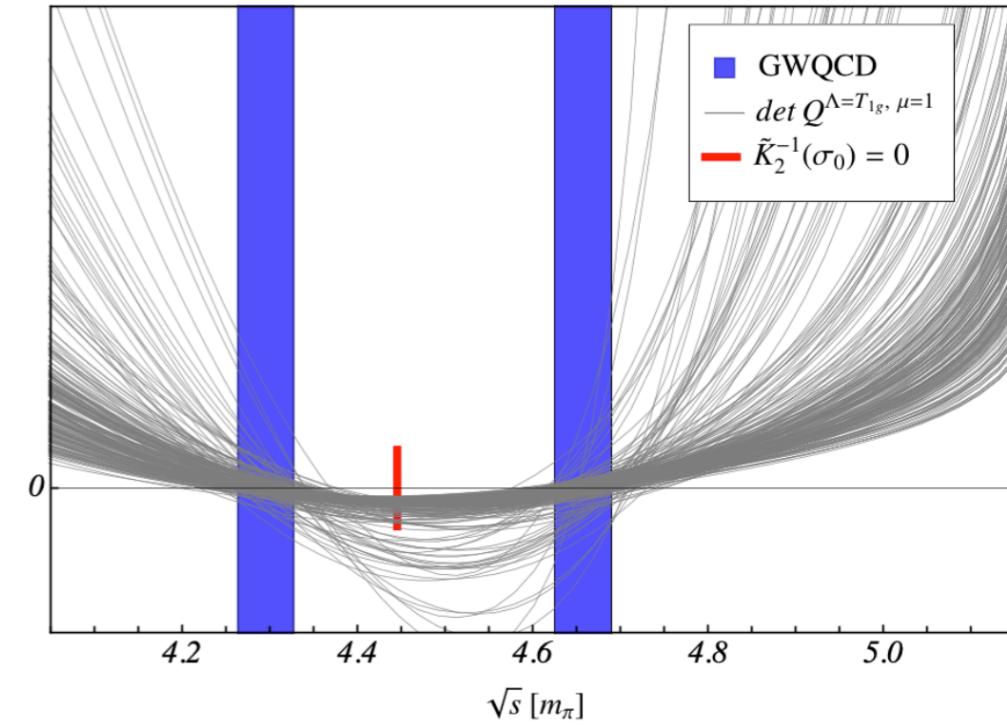

Infinite-volume scattering amplitude

- integral equation with all inputs fixed from lattice QCD results

$$T^c = B + C + \int \frac{d^3\ell}{(2\pi)^3} \frac{(B + C)}{2E_\ell} \frac{1}{\tilde{K}_n^{-1} - \Sigma_n} T^c$$

- contour deformation of spectator momenta
- analytic continuation to 2.Riemann sheet

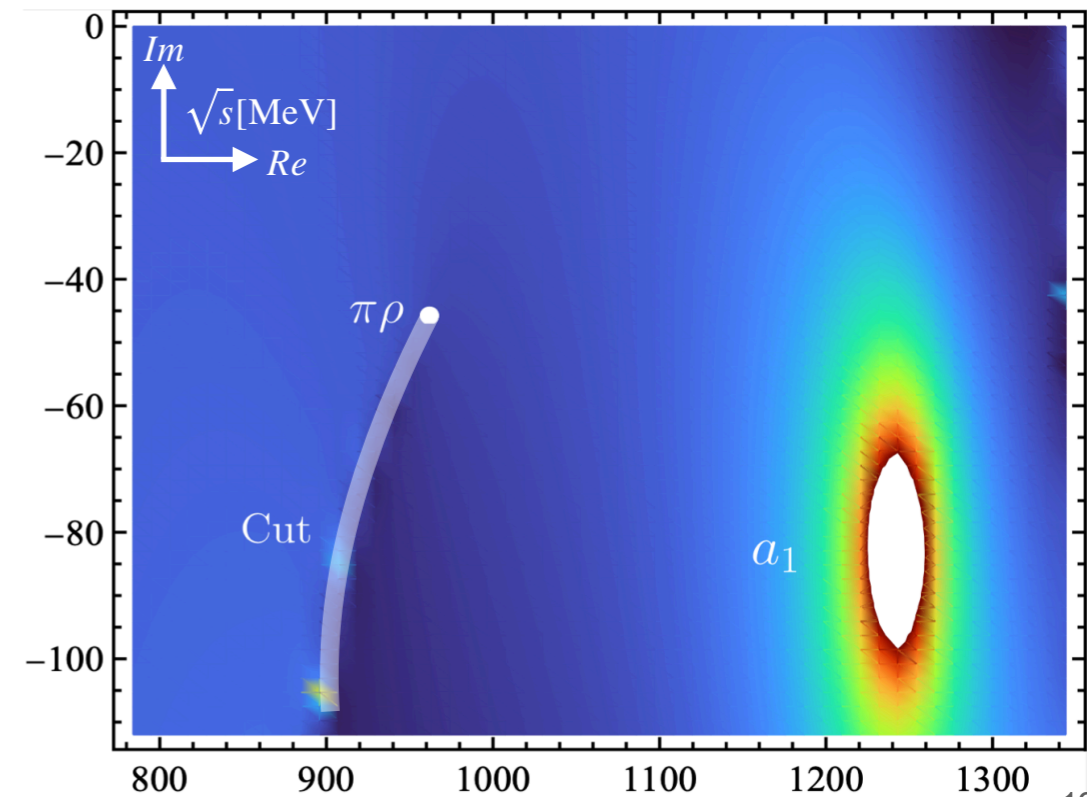

PARAMETERS OF $a_1(1260)$

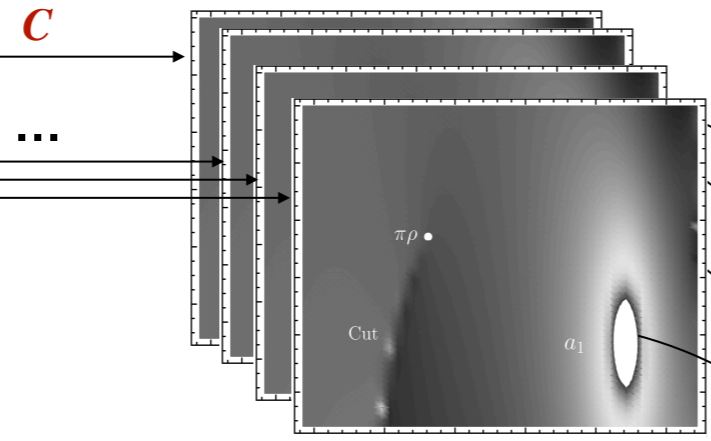
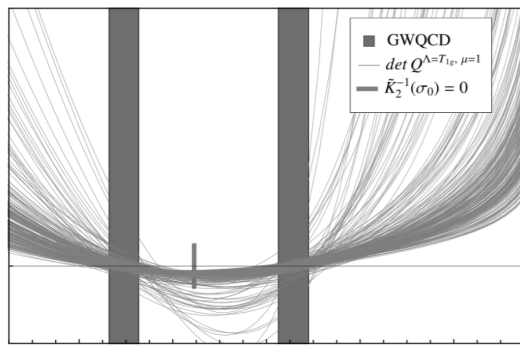

- $m_\pi=224$ MeV
- 2000 resampling sets
- distribution of poles is finite
- 90% @ $\sim((1110..1210) - (20..70)i)$ MeV

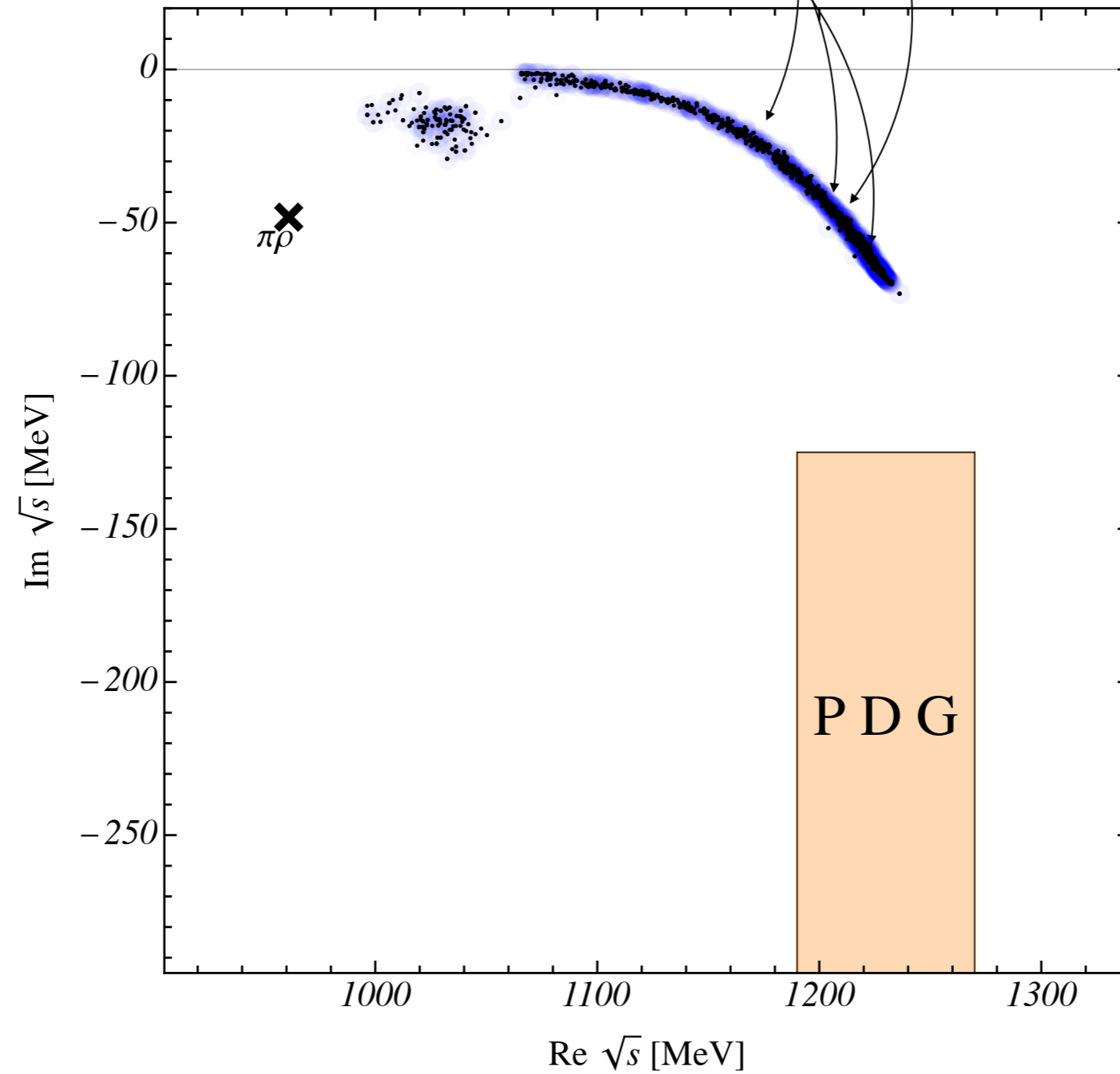

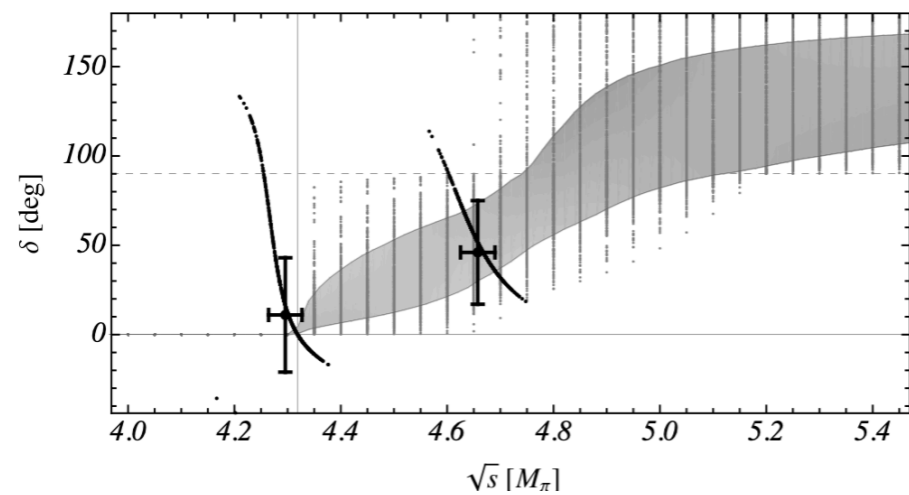

Can one use two-body approximation?

- Breit-Wigner parametrization
 - 2-body Lüscher quantization condition
- \Rightarrow very crude approximation!

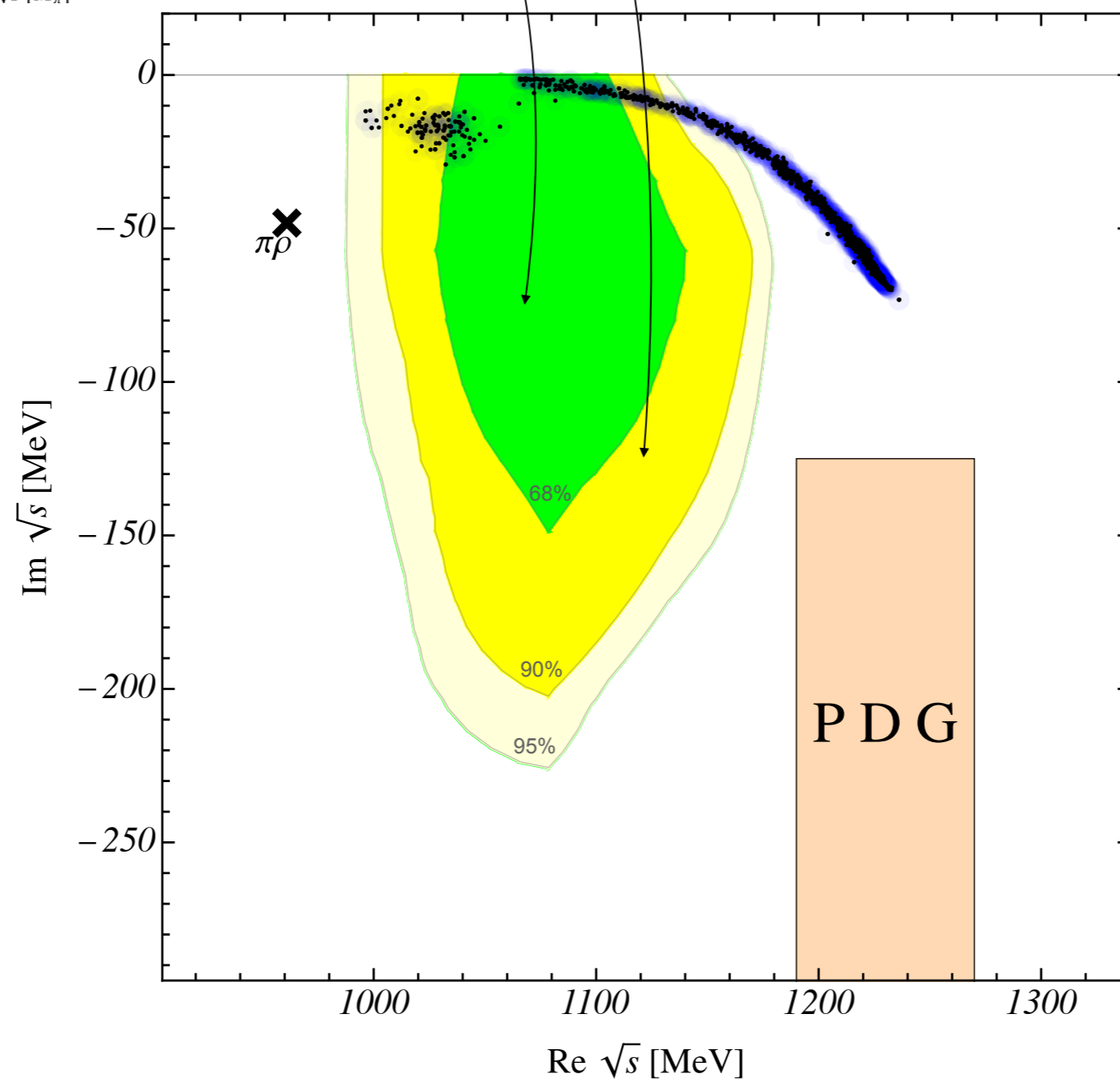

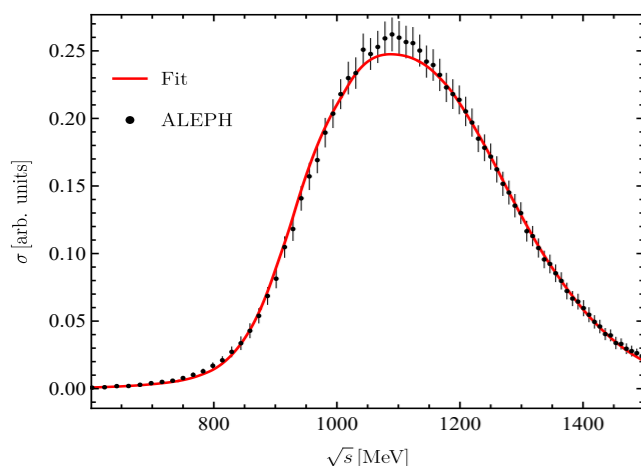

C

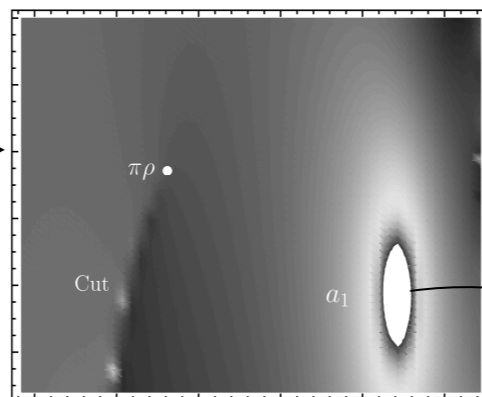

What does phenomenology says?

- $\tau \rightarrow (\pi\pi\pi)\nu_\tau$ from ALEPH@CERN
- fit to line shape to fix C

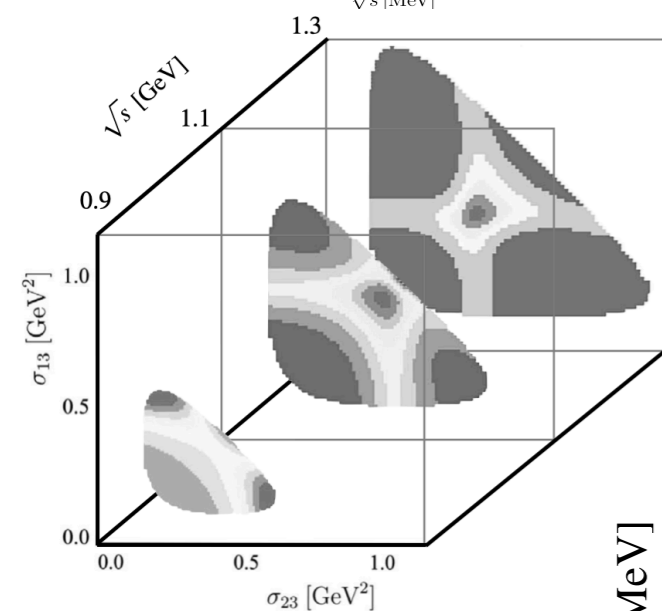

cf. Sadasivan/
MM/Döring(2020)

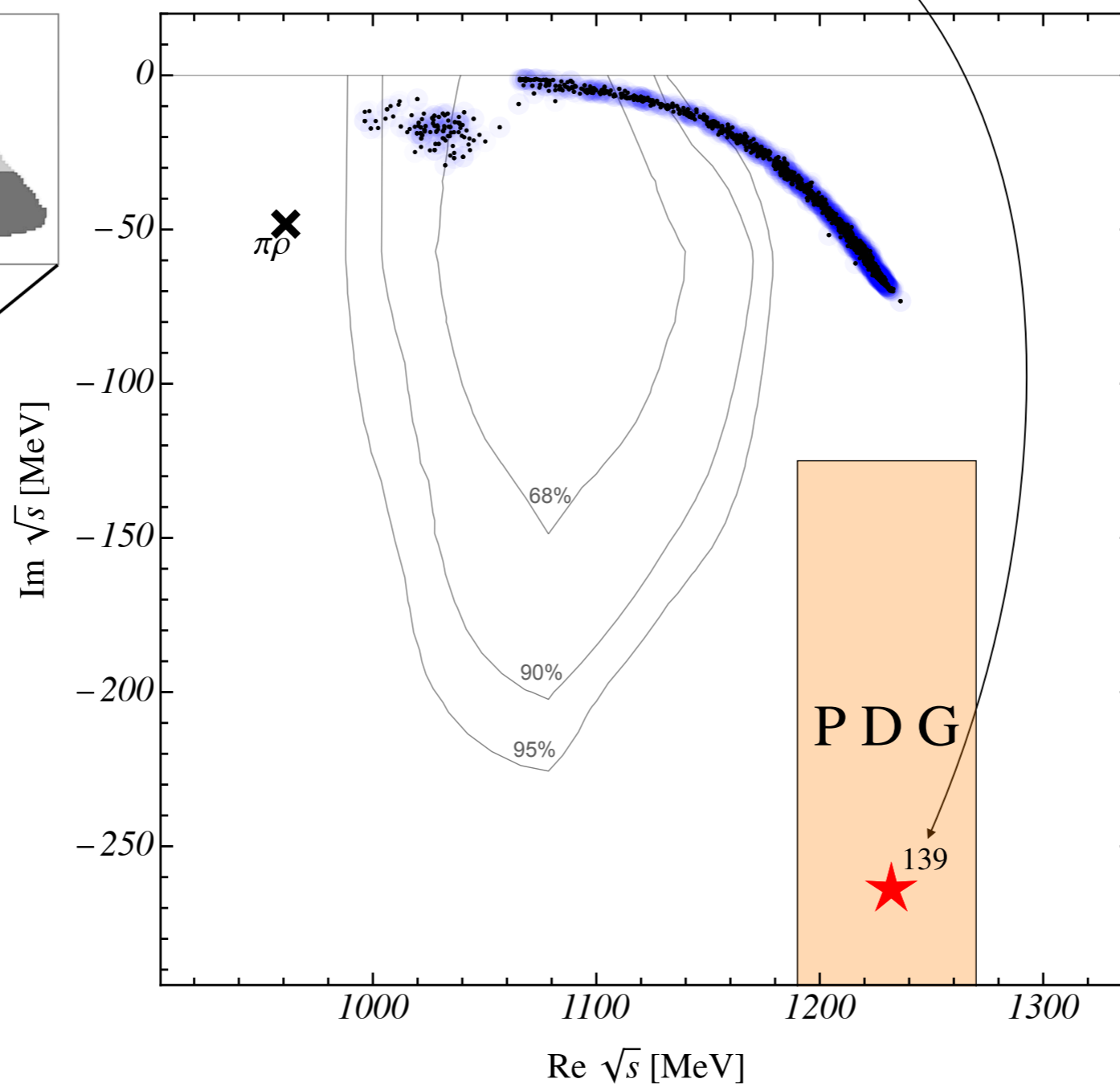

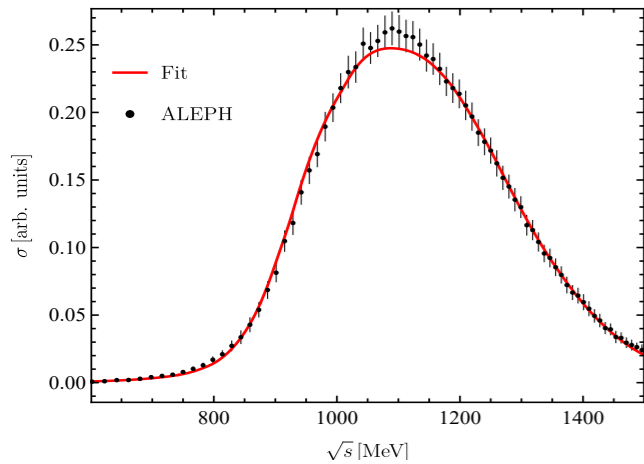

C

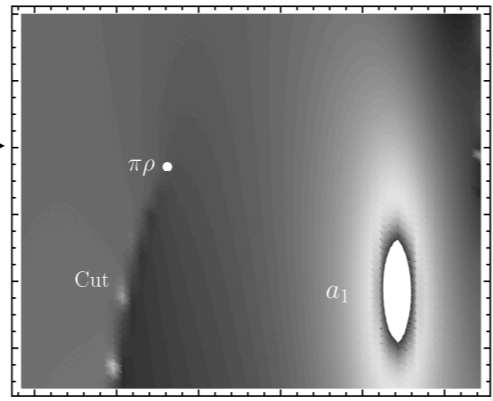

What does phenomenology says?

- $\tau \rightarrow (\pi\pi\pi)\nu_\tau$ from ALEPH@CERN
- fit to line shape to fix C

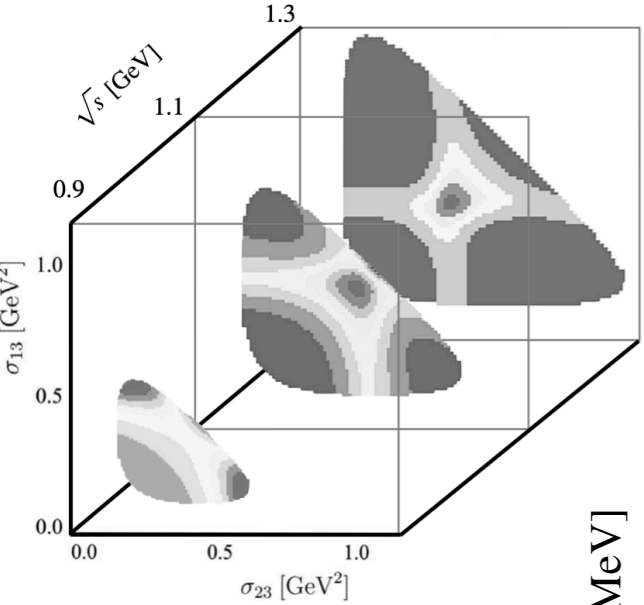

cf. Sadasivan/
MM/Döring(2020)

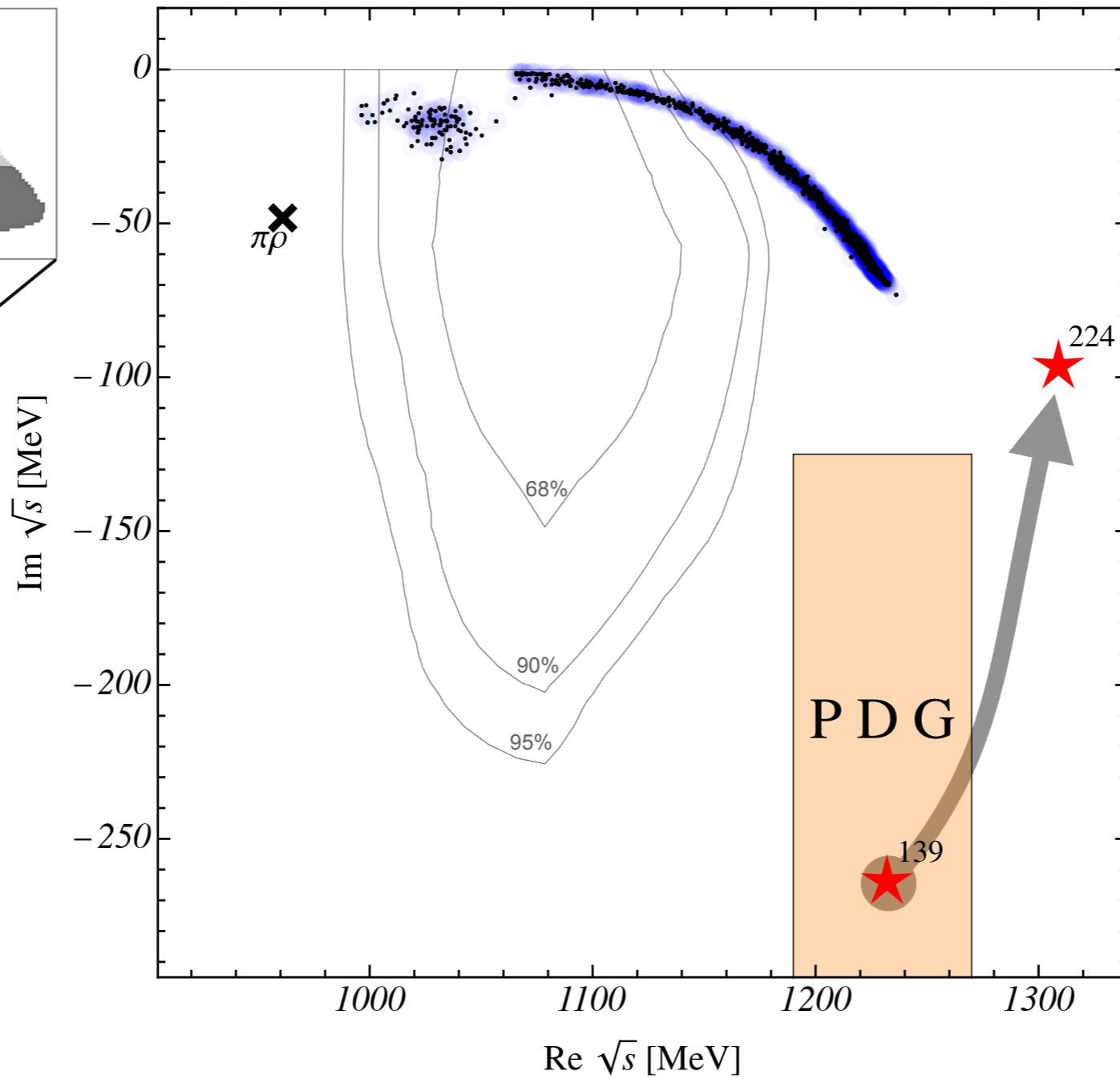

(naive) **chiral extrapolation**
confirms expectations:

- a_1 becomes heavier
- ... and narrower

First-ever determination of $a_1(1260)$ parameters from lattice QCD

- Lattice QCD levels with 1/2/3-meson operators calculated
- 3-body quantization condition extended to spin-1 systems
- unitary infinite-volume amplitude solved with complex integration contour and for complex energies
- Pole positions and couplings are determined

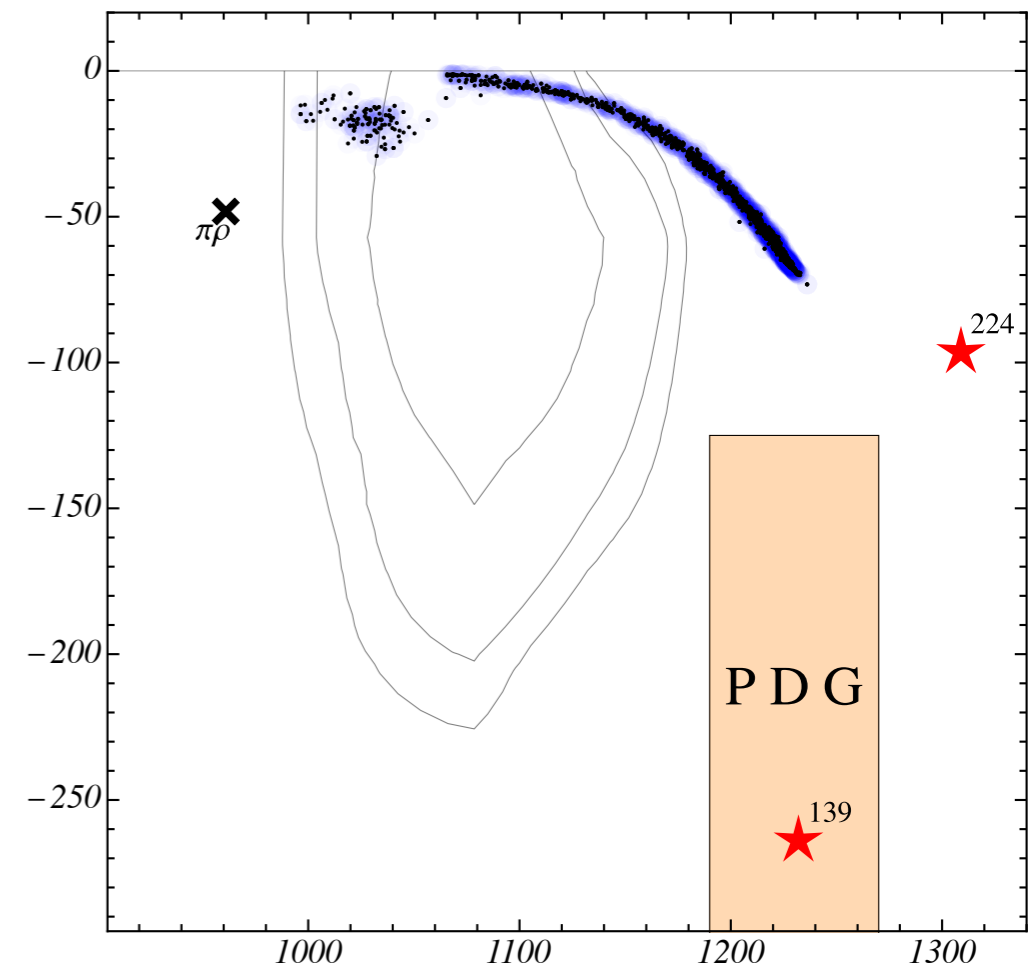

First-ever determination of $a_1(1260)$ parameters from lattice QCD

- Lattice QCD levels with 1/2/3-meson operators calculated
- 3-body quantization condition extended to spin-1 systems
- unitary infinite-volume amplitude solved with complex integration contour and for complex energies
- Pole positions and couplings are determined

Outlook

- More lattice levels (another setup: m_π, L):
 - precise determination of a_1 parameters
 - importance of the $\sigma\pi$ channels
 - chiral trajectory of three-body term C

