

Recent progress on the black hole
information paradox

Juan Maldacena

Institute for Advanced Study

We will discuss recent progress on the black hole information problem

Review: Almheiri, Hartman, JM, Shaghoulian, Tajdini
(this contains a more general list of references than this talk)

Two important papers in 2019: Penington
Almheiri, Engelhardt, Marolf, Maxfield
...many previous and follow up papers...

Also papers by: Saad, Shenker, Stanford

Outline

- Black hole entropy.
- The fine-grained gravitational entropy formula.
- Compute the entropy of radiation coming out of black holes.
- Get a result consistent with information conservation (as opposed to information loss).

It will not be historical, but hopefully pedagogical...

Black holes

- Black holes have a temperature.

Hawking

- 1st Law, $dM = TdS$, \rightarrow Entropy

Bekenstein Hawking

$$S_{\text{gen}} = \frac{\text{Area}_H}{4G_N}$$

- Area increase theorem \rightarrow 2nd Law.

Hawking

Semiclassical gravity

(as an effective field theory)

- Treat the background geometry as classical.
- Quantum fields propagating on a classical background. (Including perturbative gravitons).
- Backreaction due to Hawking radiation treated using the semiclassical equations.

Effective coupling: $g_{eff}^2 \propto \frac{G_N}{r_s^2} \propto 1/S$

Energy spacings $\sim e^{-S} \sim e^{-\frac{1}{g_{eff}^2}} \longrightarrow$

Microstates seem to require non-perturbative accuracy

Entropy, again

$$S = \frac{\text{Area}_H}{4G_N} + S_{\text{semi-cl}}(\text{Outside})$$

← Von Neuman entropy, or quantum entropy,
of the semiclassical quantum fields in the
region outside Σ
(entanglement entropy of the quantum fields)

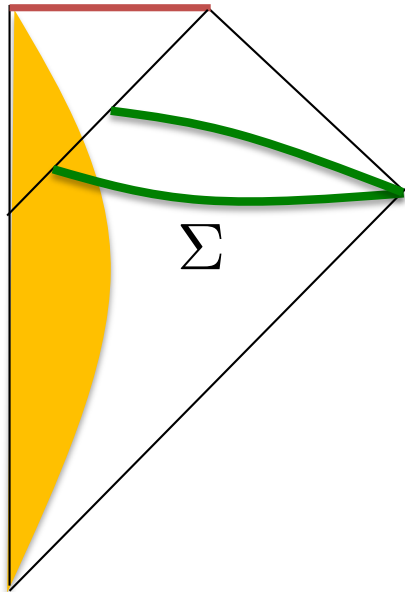

Obeys the 2nd law

Wall

These results have inspired a very influential hypothesis:

A “central dogma” in the study of quantum aspects of black holes

The Central Dogma

Black holes as quantum systems

- A black hole seen from the outside can be described as a quantum system with S degrees of freedom (qubits). $S = \text{Area}/4$ ($l_p = 1$)
- It evolves according to unitary evolution, as seen from outside.

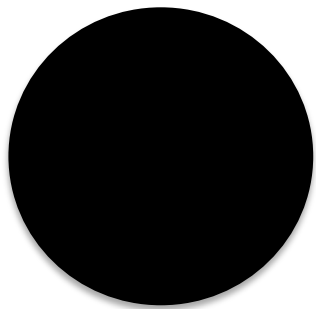

=

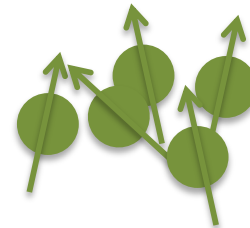

Black holes as quantum systems

- A black hole seen from the outside can be described as a quantum system with S degrees of freedom (qubits). $S = \text{Area}/4$ ($l_p = 1$)
- It evolves according to unitary evolution, seen from outside.

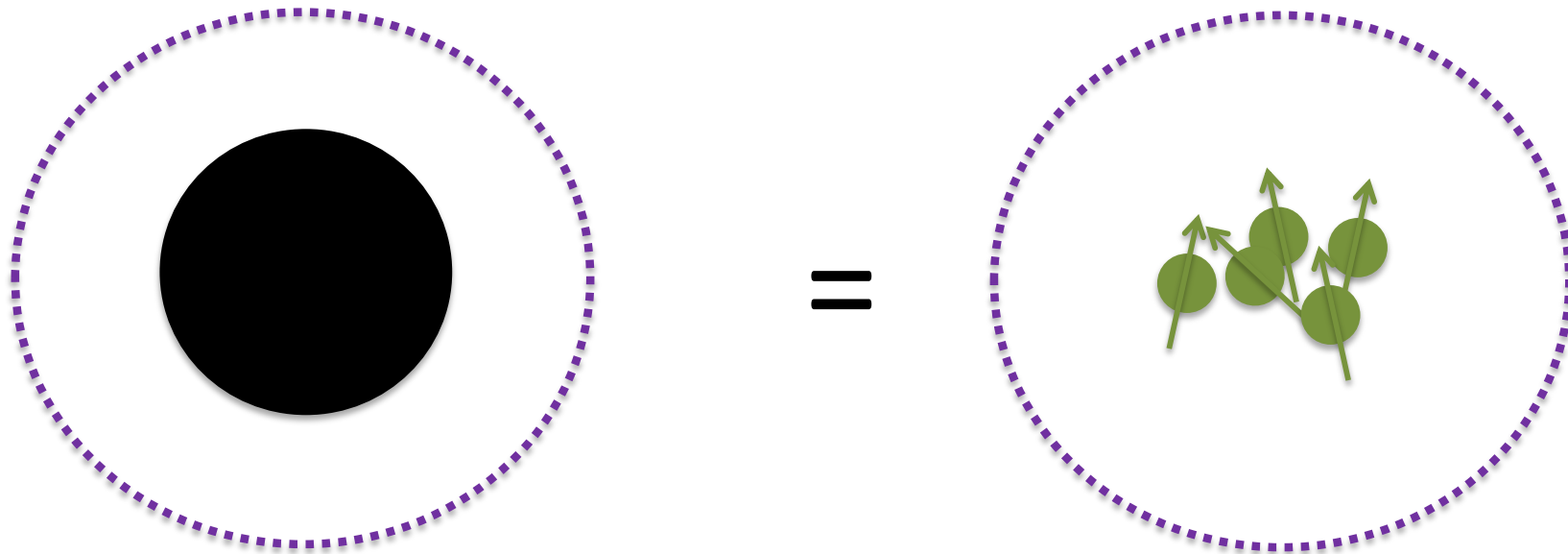

The Central Dogma

Black holes as quantum systems

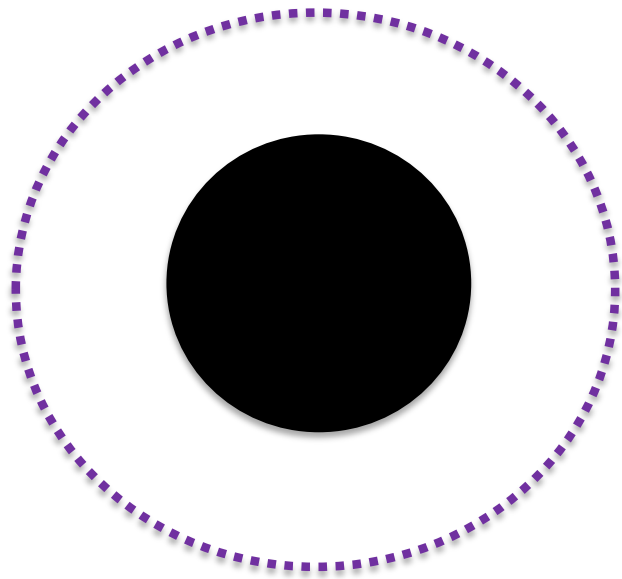

=

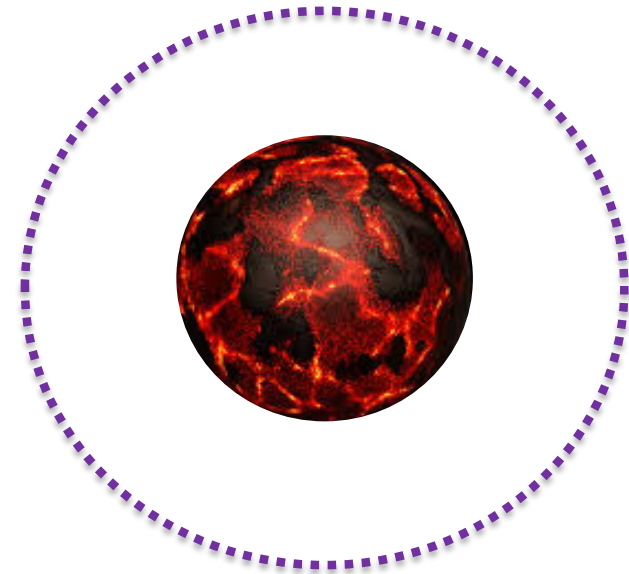

Piece of coal (strongly interacting)

Note:

- These $A/4G_N$ qubits, are not very manifest in the gravity description.

It is only a statement about the black hole as seen from the outside !

No statement has been made about the inside (yet).

Evidence

1) Entropy counting

Supersymmetric black holes in supersymmetric string theories can be counted precisely using strings/D-branes
→ reproduce the Area formula. (+ also corrections to this formula)

Strominger Vafa.....

Sen.... Dabholkar, Gomes, Murthy...

2) Matrix theory

Banks, Fischler, Shenker, Susskind

- BFSS matrix model \rightarrow describes 11 dimensional black hole formation and evaporation. Gives us the S-matrix.

3) AdS/CFT...

JM
Gubser, Klebanov, Polyakov
Witten

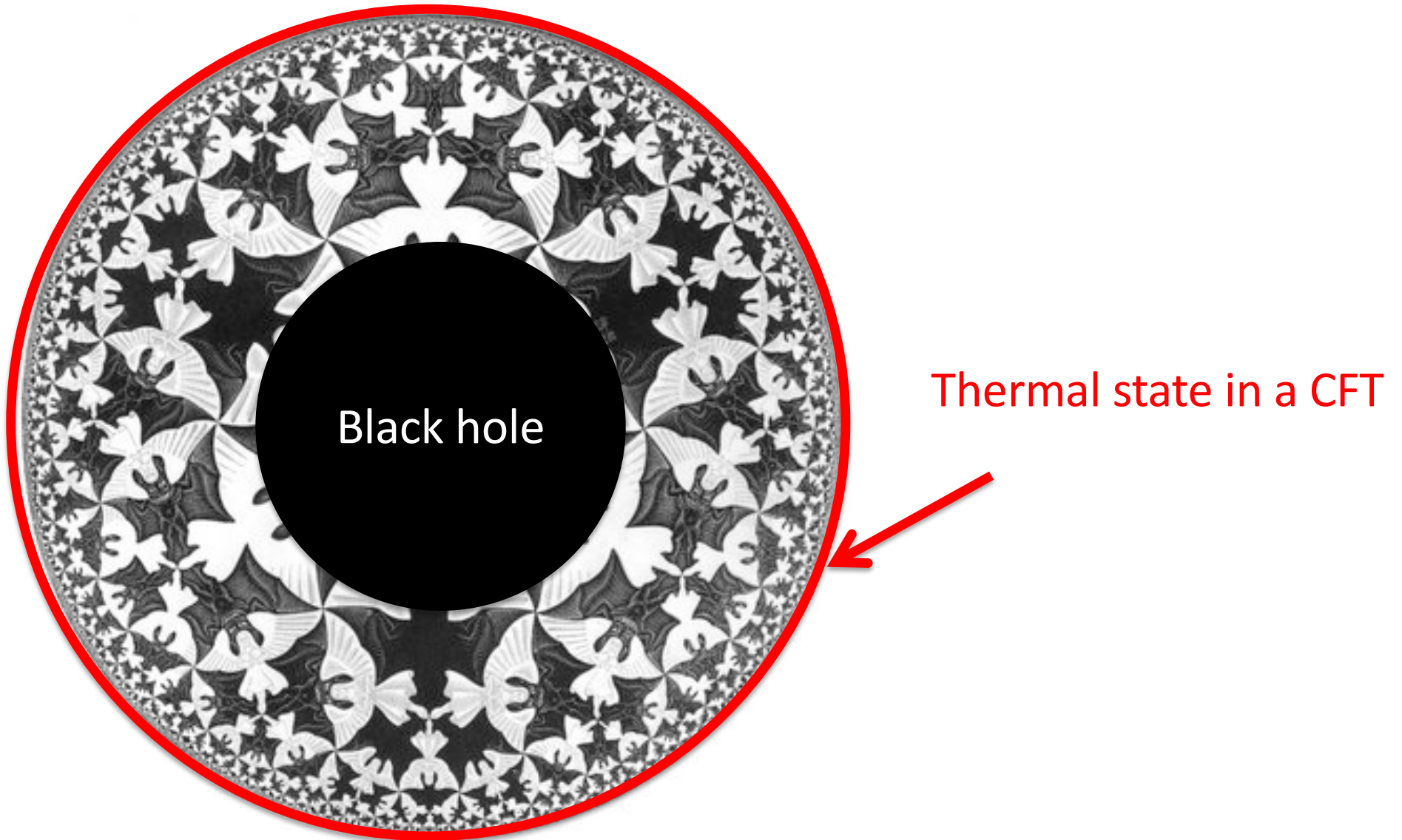

but

Hawking 1976 :

This can't possibly be true!

Geometry of an evaporating black hole made from collapse

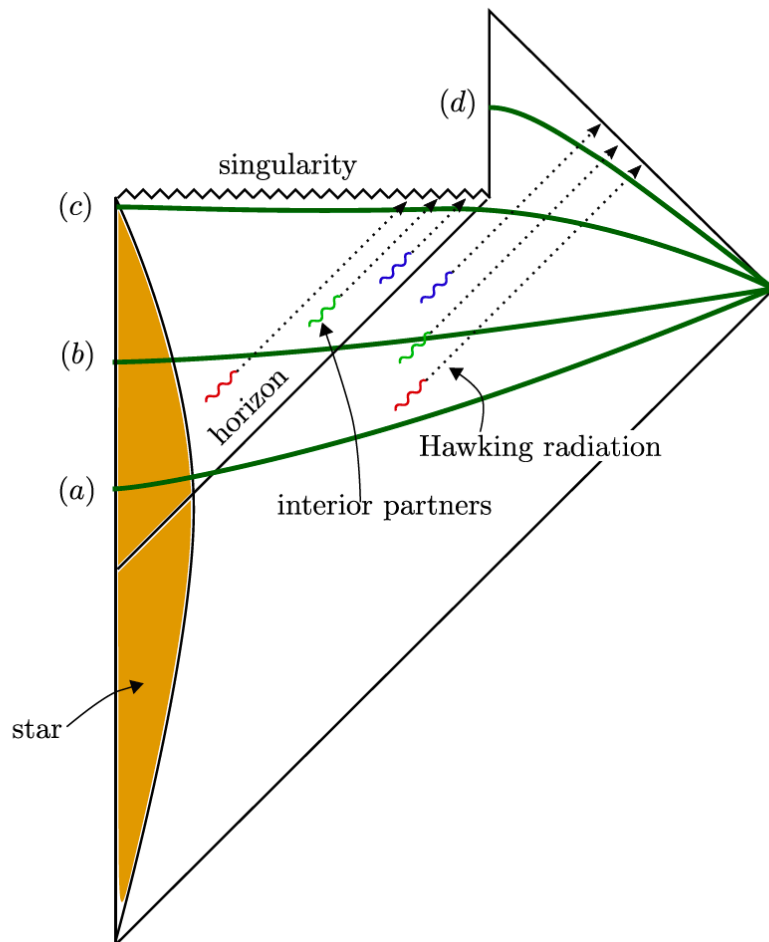

The radiation is entangled with partners of radiation.

Since we do not measure the interior we get a large entropy for the radiation.

A pure state seems to go a mixed state.

The skeptic's view:

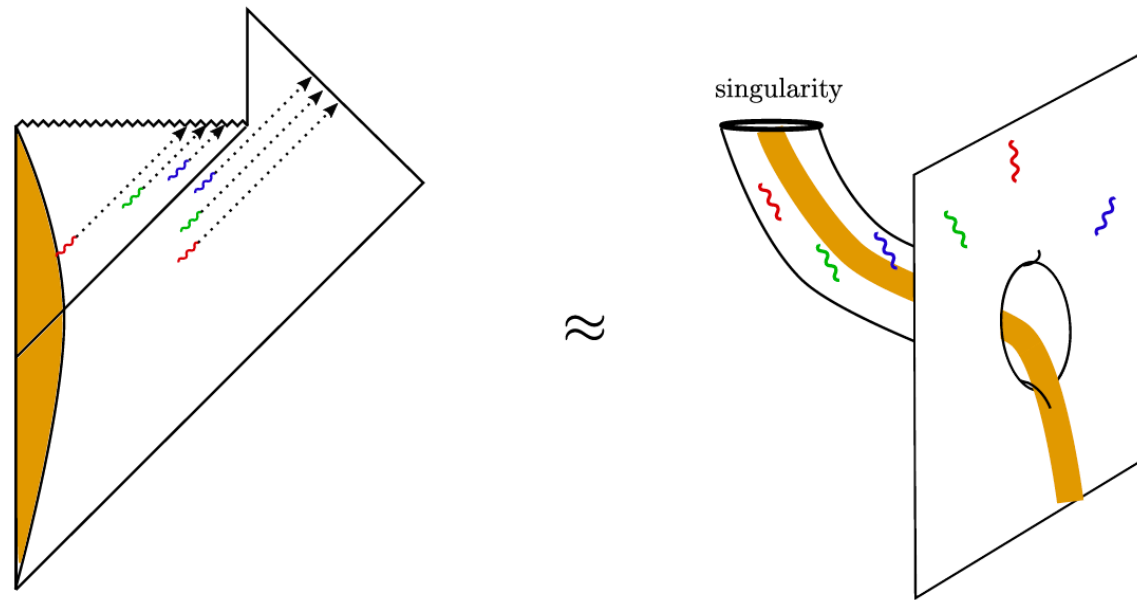

One universe splits of a ``teenage universe'' (big baby universe)

The state is pure if you include both universes, but not if you look only at the original universe.

The Hawking curve

Compute the fine-grained entropy of the radiation as it comes out of the black hole (formed by a pure state)

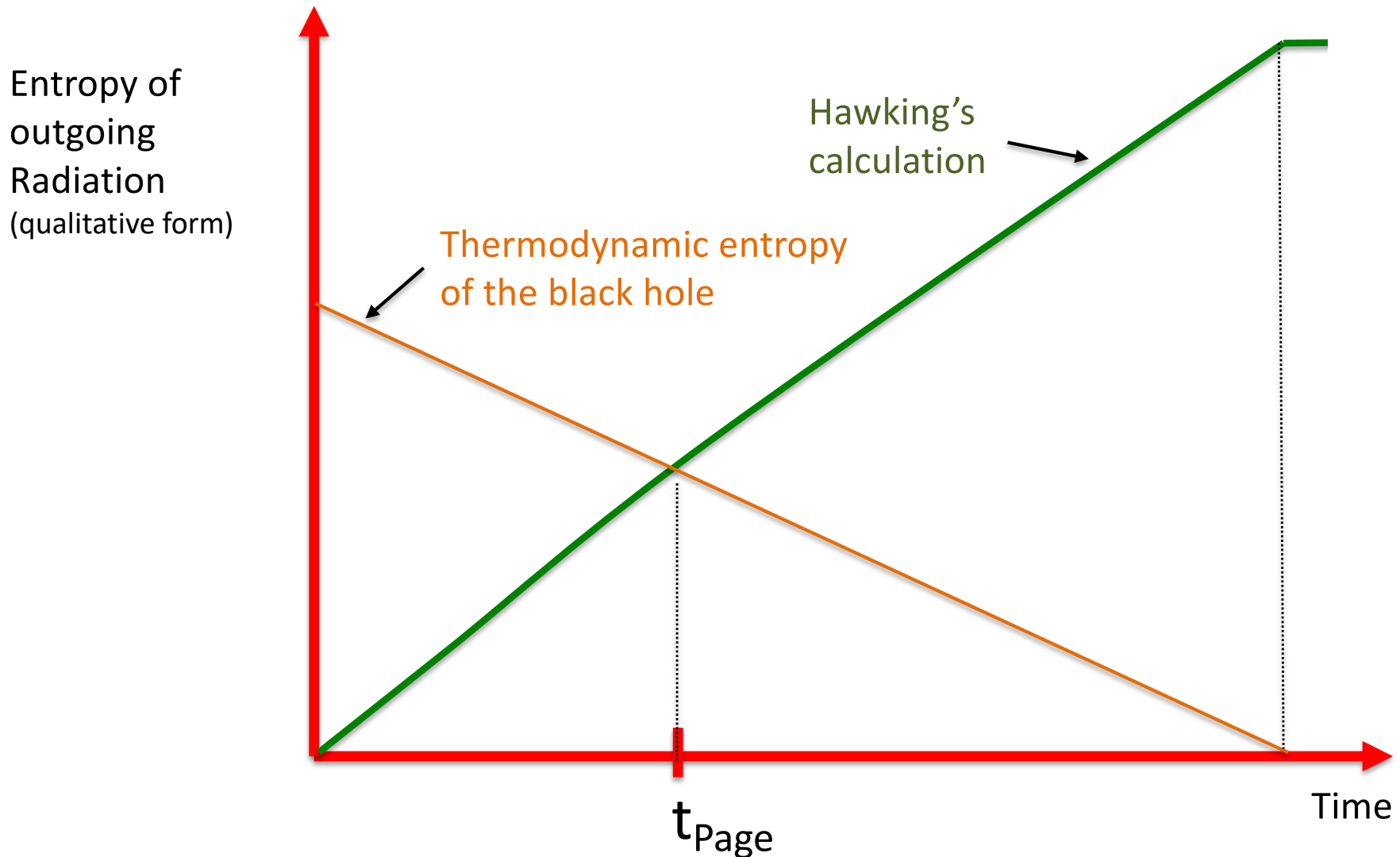

The Hawking curve vs. the Page curve

Compute the fine-grained entropy of the radiation as it comes out of the black hole (formed by a pure state)

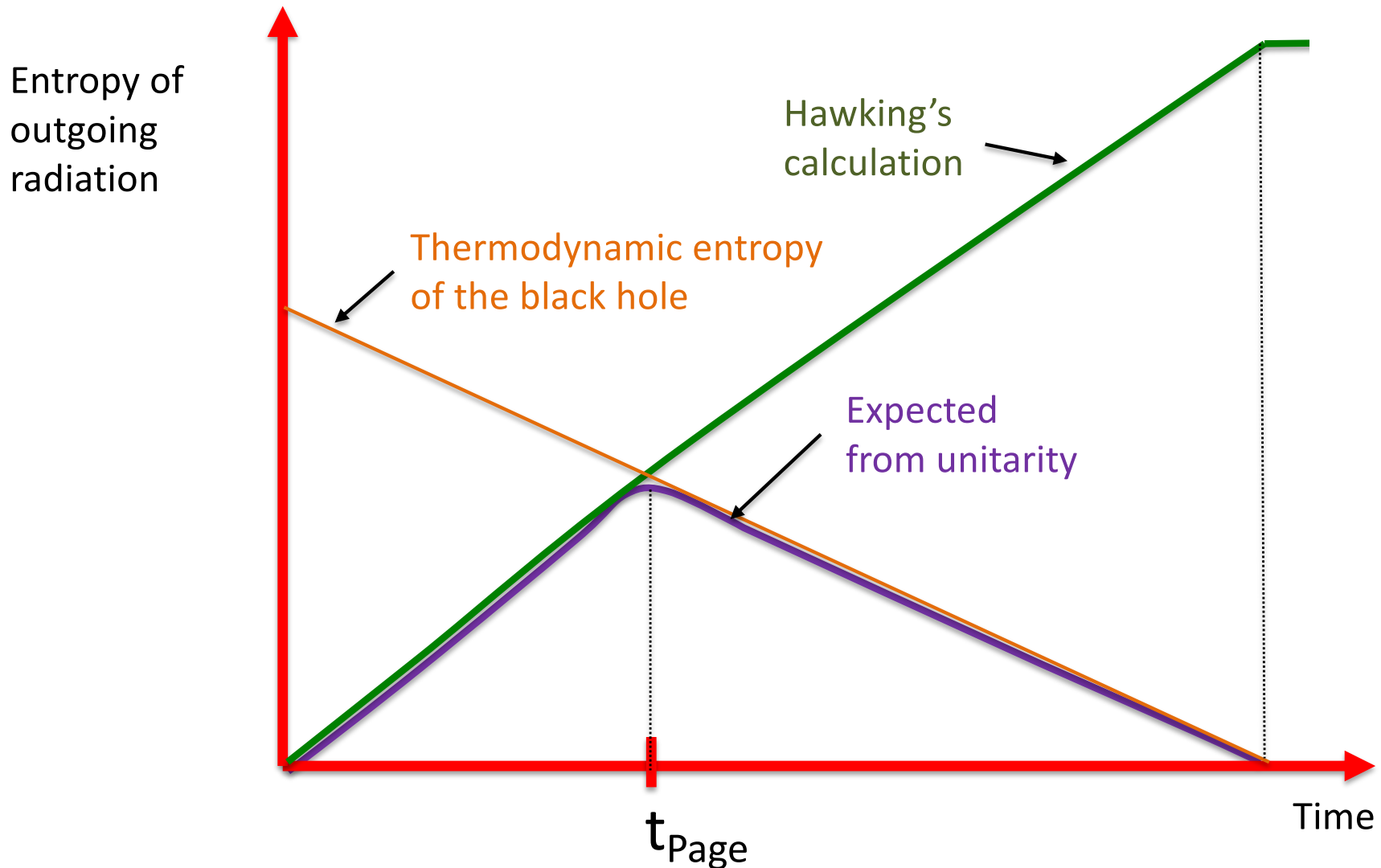

There were other apparent paradoxes with the black hole entropy formula.

Full Schwarzschild solution

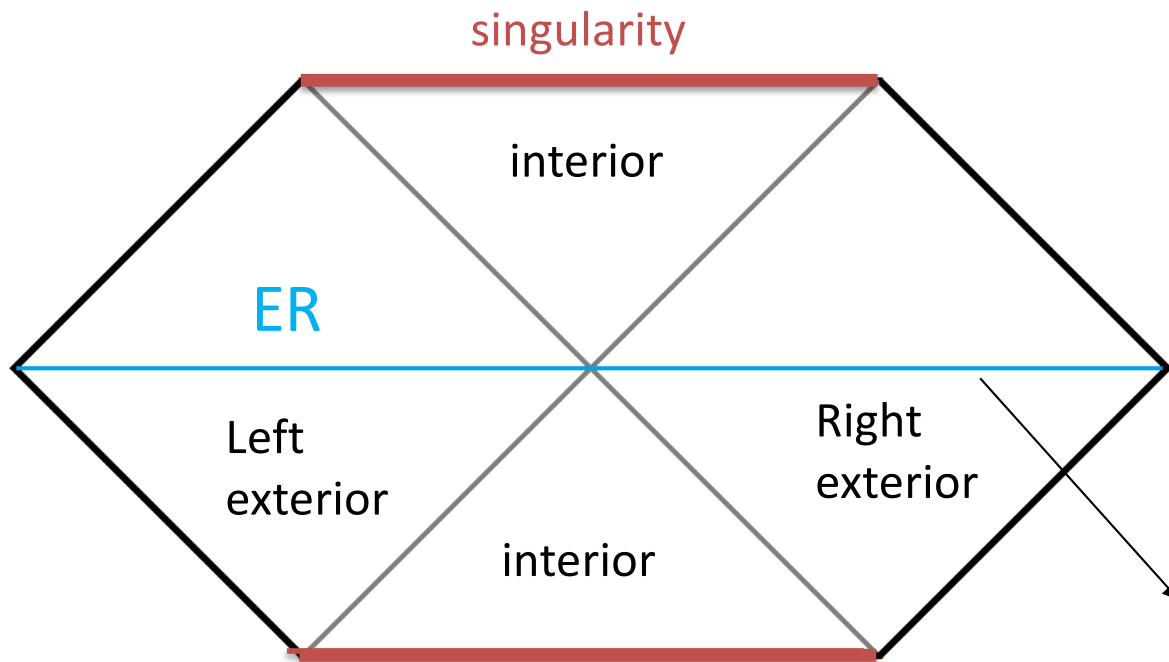

Eddington, Lemaitre, Einstein,
Rosen, Finkelstein,
Kruskal

Vacuum solution. No matter.
Two exteriors, sharing the interior.

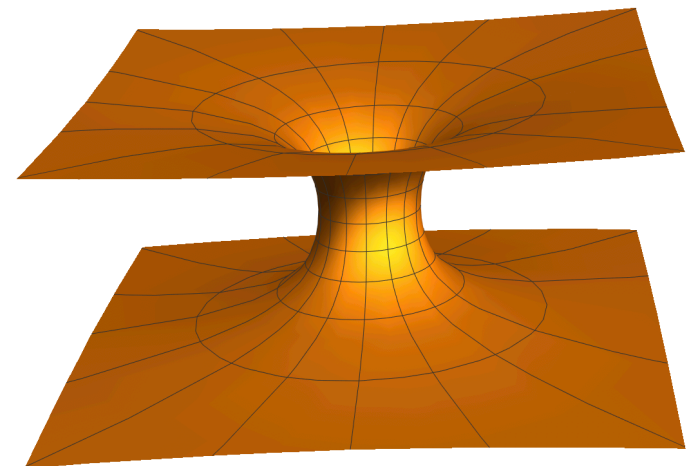

``Bags of Gold''

Wheeler

Initial slice:

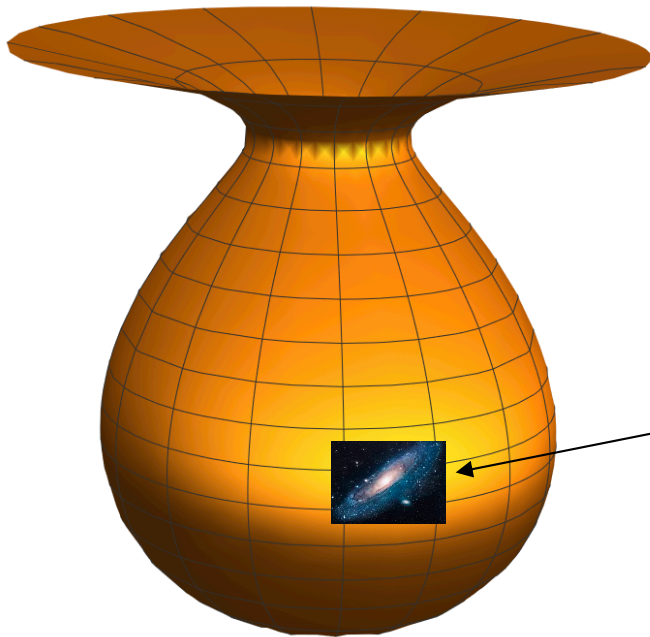

Evolves to a black hole as seen from the outside and a black hole in a closed universe.

Can have arbitrarily large amount of entropy ``inside''

Counterexample to the statement that the Area entropy counts the entropy "inside" or the entropy of the ``interior''.

We will see how to resolve these
confusions

- These confusions involve the black hole interior.

Wormholes and entangled states

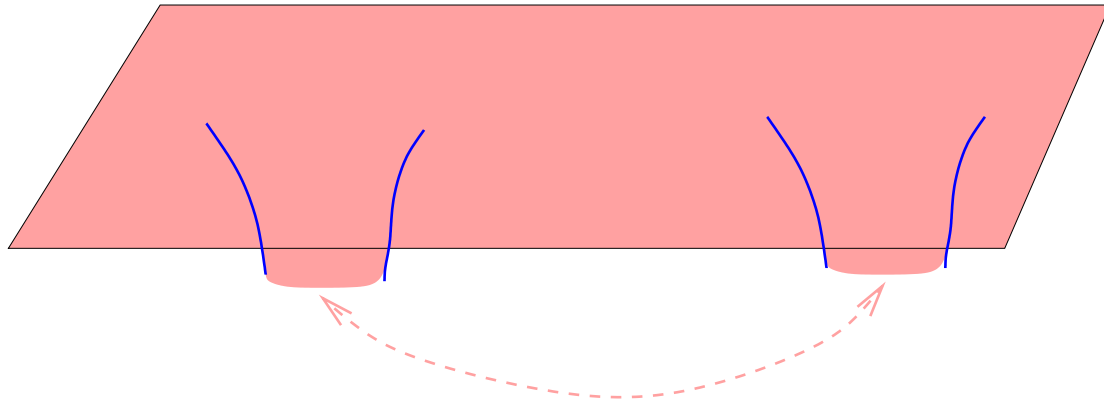

Connected through the interior

=

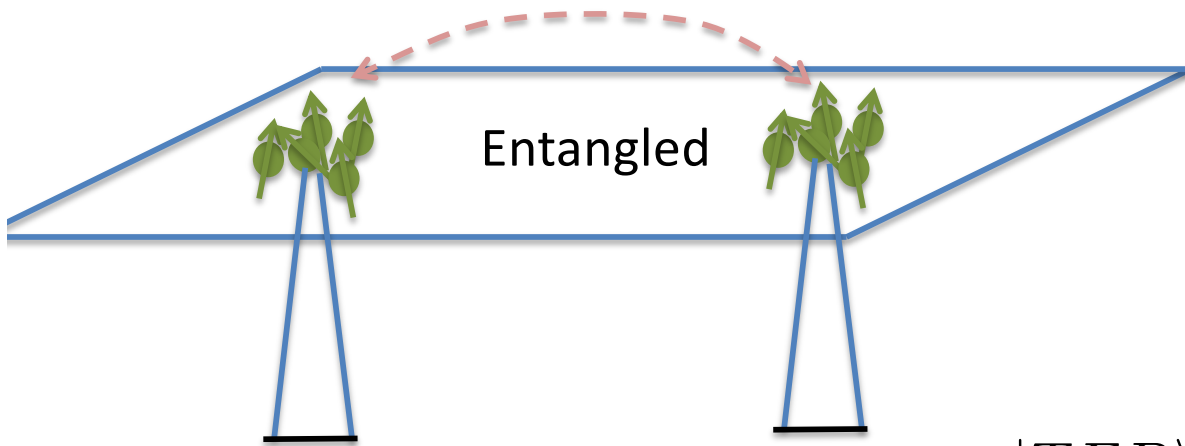

ER = EPR

W. Israel
J.M.
JM Suskind

$$|TFD\rangle = \sum_n e^{-\beta E_n/2} |\bar{E}_n\rangle_L |E_n\rangle_R$$

The rest of the paradoxes involve understanding fine-grained entropy

Two notions of entropy

- Fine grained entropy. (Also called Von Neuman entropy, or quantum entropy, or “entanglement” entropy)

$$S = -\text{Tr}[\rho \log \rho]$$

Remains constant under unitary time evolution.

- Coarse grained entropy = thermodynamic entropy. Arises from “sloppiness”

$$S = \max_{\hat{\rho}} (-\text{Tr}[\hat{\rho} \log \hat{\rho}]) \quad , \quad \text{Tr}[A\hat{\rho}] = \text{Tr}[A\rho]$$

Obeys 2nd law.

Subset of observables, “simple observables”, eg. $A = E, Q, \dots$

For the moment we will be talking about the entropy of the black hole as seen from the outside.

This is the entropy of the quantum system that appeared in the “central dogma”.
The entropy of the “piece of coal”.

The horizon area computes
thermodynamic entropy

How can we compute the fine grained one ?

Fine grained gravitational entropy

Ryu-Takayanagi 2006

Hubeny, Rangamani, Takayanagi 2007

Faulkner, Lewkowycz, JM 2013

Engelhardt, Wall 2014

$$S = \min_X \left\{ \text{ext}_X \left[\frac{\text{Area}(X)}{4G_N} + S_{\text{semi-cl}}(\Sigma) \right] \right\}$$

Follows from AdS/CFT rules:
Lewkowycz, JM, Faulkner, Dong, ...

The final surface is called minimal quantum extremal surface.

Also maxi-min: minimize along a spatial slice (Cauchy slice) and then maximize among all possible Cauchy slices.

Wall; Akers, Engelhardt, Penington, Usatyuk.

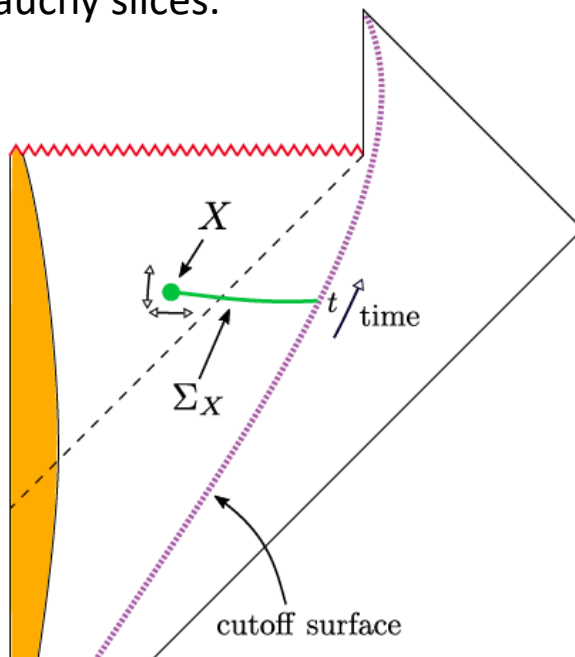

We are allowed to take the surface to the inside. It depends on the geometry of the interior

We should be surprised by the claim
that there is a formula for the fine-
grained entropy

Example

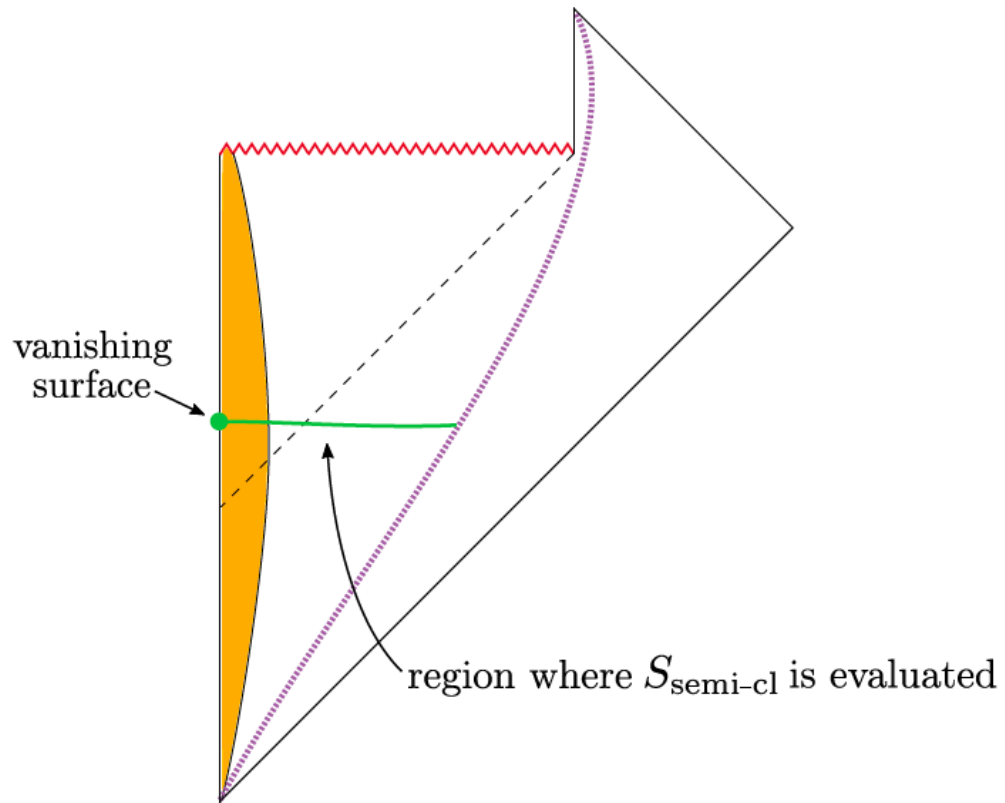

S = Entropy of star , which is zero if it was in a pure state.

New quantum extremal surface

Penington

Almheiri, Engelhardt, Marolf, Maxfield, 2019

First appears about a scrambling time ($r_s \log S$) after the black hole forms.

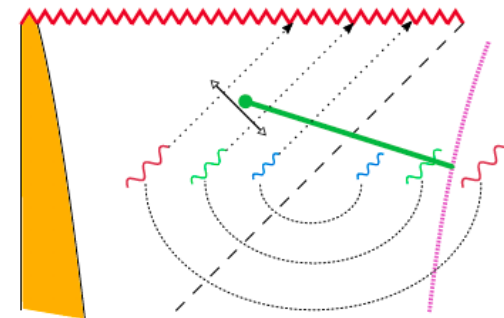
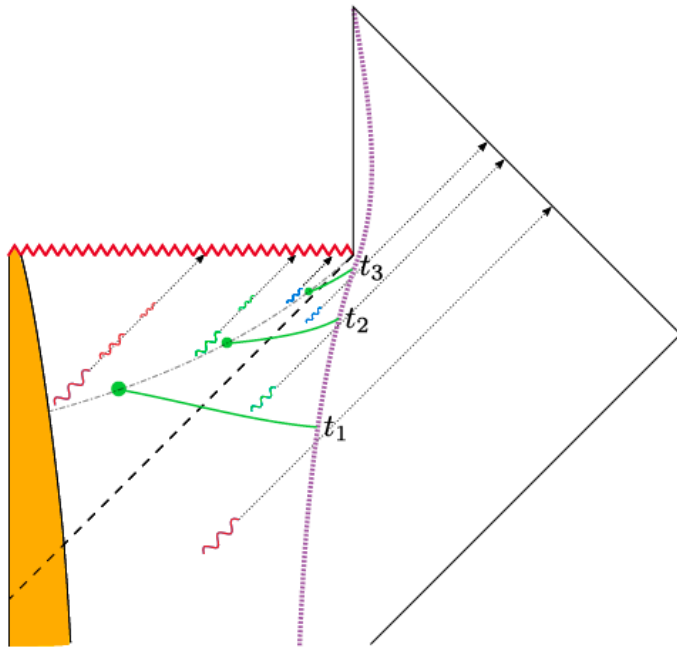

Its entropy is close to the area of the horizon at the time.

Two quantum extremal surfaces

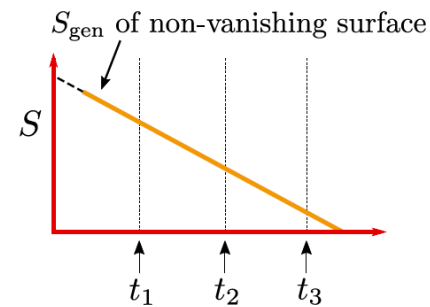
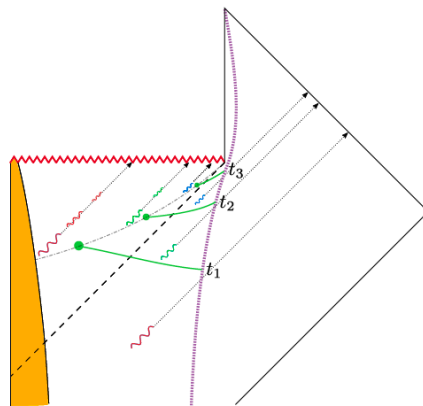
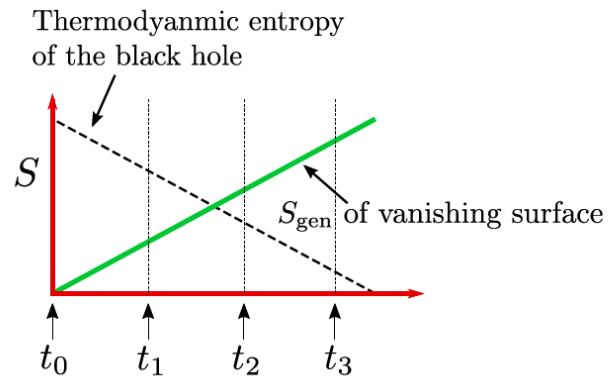
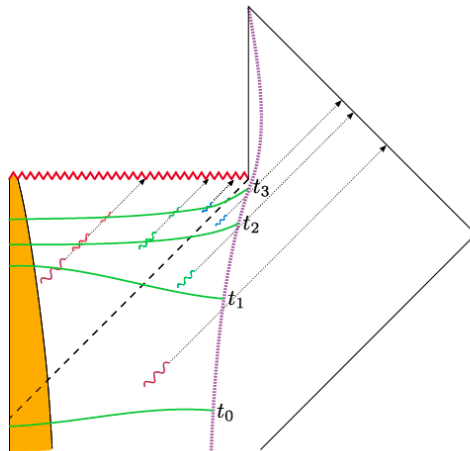

Choose the minimal one

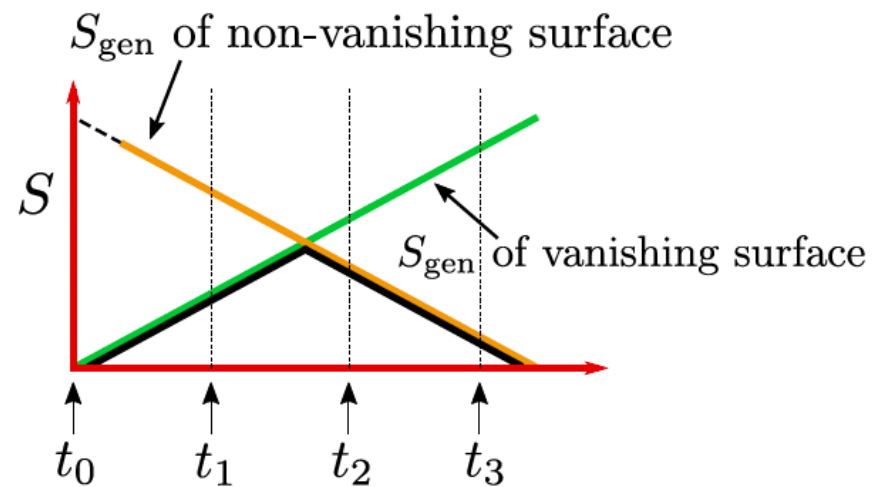
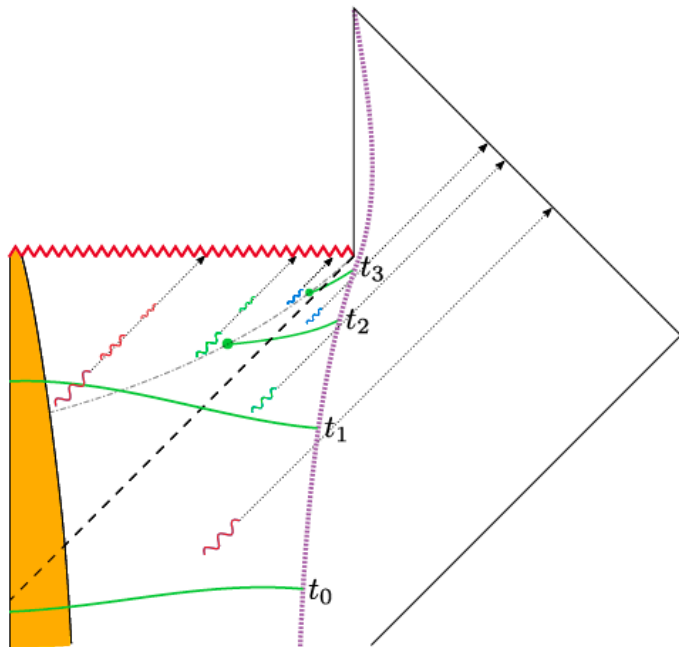

...we get the Page curve for the black
hole

but

we really wanted the Page curve for
the radiation!

- The radiation lives in a region where quantum gravity effects could be very small. (It could have left the AdS space, or it could be collected into a far away quantum computer).
- Since we obtained the state using gravity → we should apply the gravitational fine-grained entropy formula!

The “Island” formula

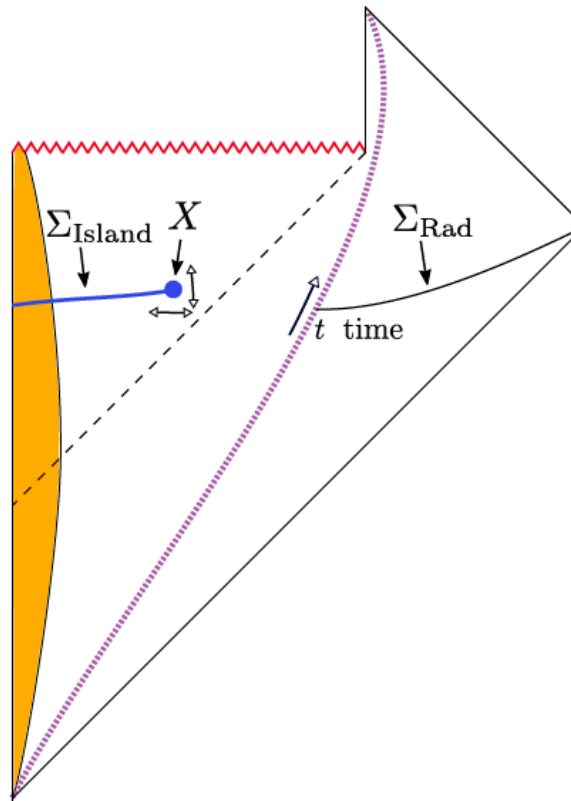

$$S_{\text{Rad}} = \min_X \left\{ \text{ext}_X \left[\frac{\text{Area}(X)}{4G_N} + S_{\text{semi-cl}}[\Sigma_{\text{Rad}} \cup \Sigma_{\text{Island}}] \right] \right\}$$

We should view it as just a special case of the general gravitational fine-grained entropy formula

The “Island” formula

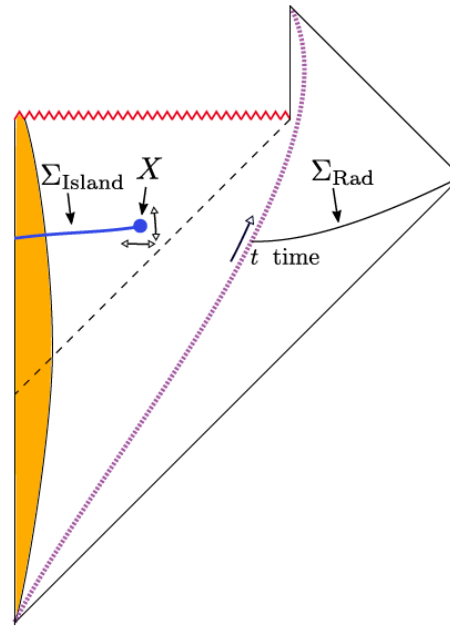

$$S_{\text{Rad}} = \min_X \left\{ \text{ext}_X \left[\frac{\text{Area}(X)}{4G_N} + S_{\text{semi-cl}}[\Sigma_{\text{Rad}} \cup \Sigma_{\text{Island}}] \right] \right\}$$

Entropy of the exact
radiation state

Entropy of the state in the semiclassical description

- If the initial matter state is pure, then the quantum extremal surfaces are the same as the ones we discussed before.
- Therefore we get the Page curve for radiation.

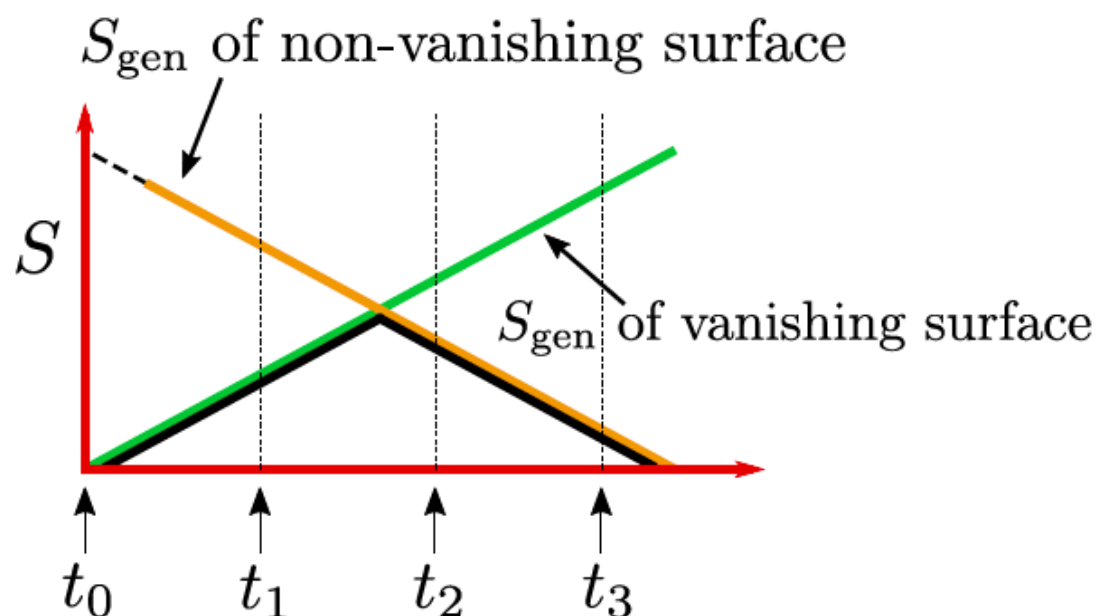

The skeptic's complaint

- “This is just an accounting trick!”
- I have always said: “If you include the black hole interior, then the state is pure. The information problem arises because you do not have access to the interior!”

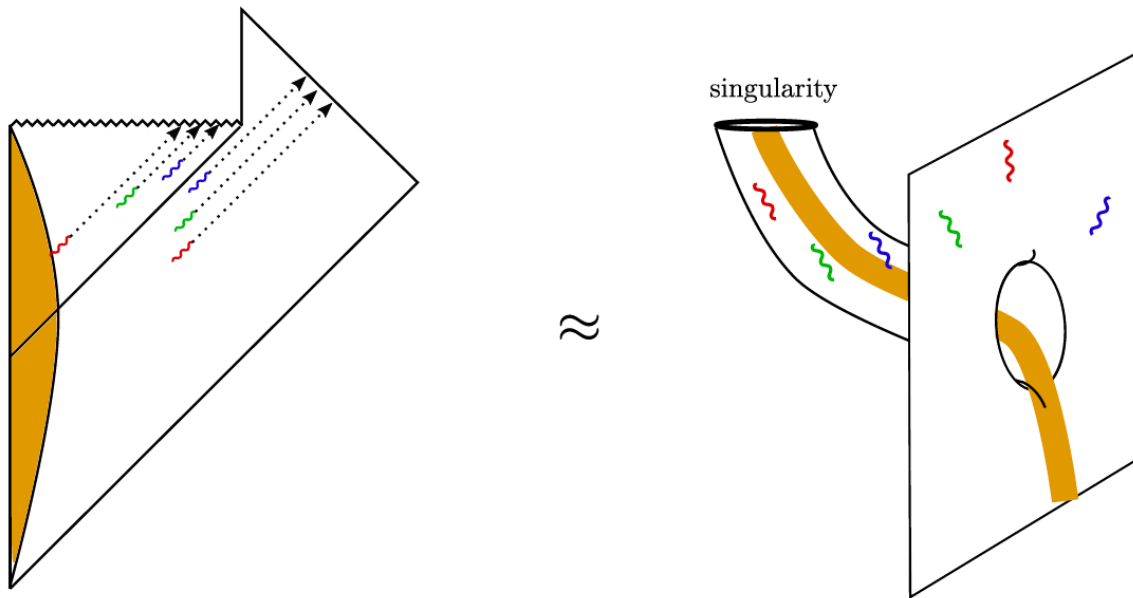

Gravity's accounting ``trick'' → ``oracle''

- It can be derived from the gravitational path integral. (Deriving the Ryu-Takayanagi formula and its generalizations)
- Oracle: It gives us the true fine-grained entropy of the exact state, but using only the semiclassical state.

Deriving the RT formula

- It is conceptually similar to the derivation of the black hole entropy using the Euclidean black hole.

Lewkowycz, JM ;
Faulkner, Lewkowycz, JM;
Dong, Lewkowycz, Rangamani;
Dong, Lewkowycz

Euclidean black hole

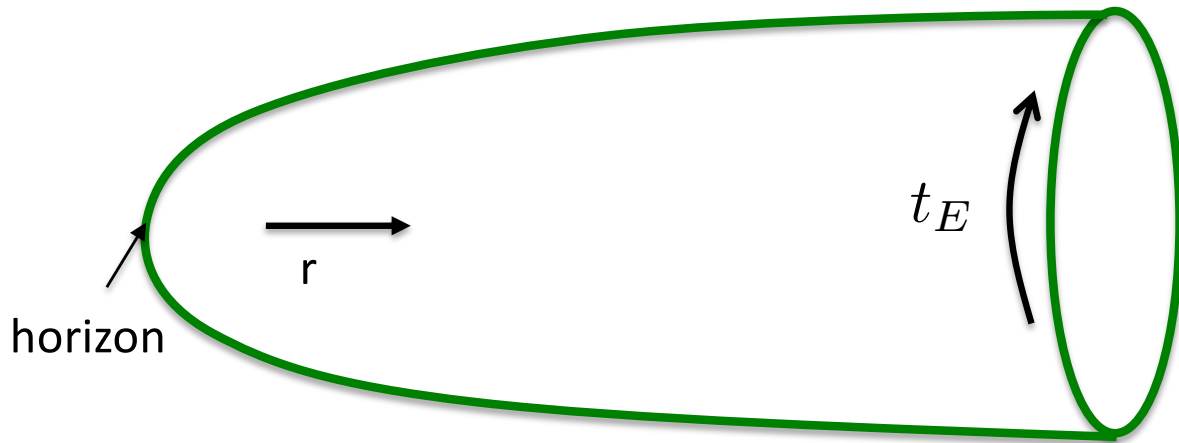

“cigar”

Gibbons
Hawking

$$\text{Tr}[e^{-\beta H}] = Z_{\text{grav}} \sim e^{-I_{\text{grav}}} Z_{\text{semi-cl}}$$

$$I_{\text{grav}} \propto -\frac{1}{G_N} \int \sqrt{g} R + \dots$$

$$S = (1 - \beta \partial_\beta) \log Z = \frac{\text{Area}}{4G_N} + S_{\text{semi-cl}}$$

Fix the temperature far away, gravity chooses the geometry dynamically.

Euclidean black hole

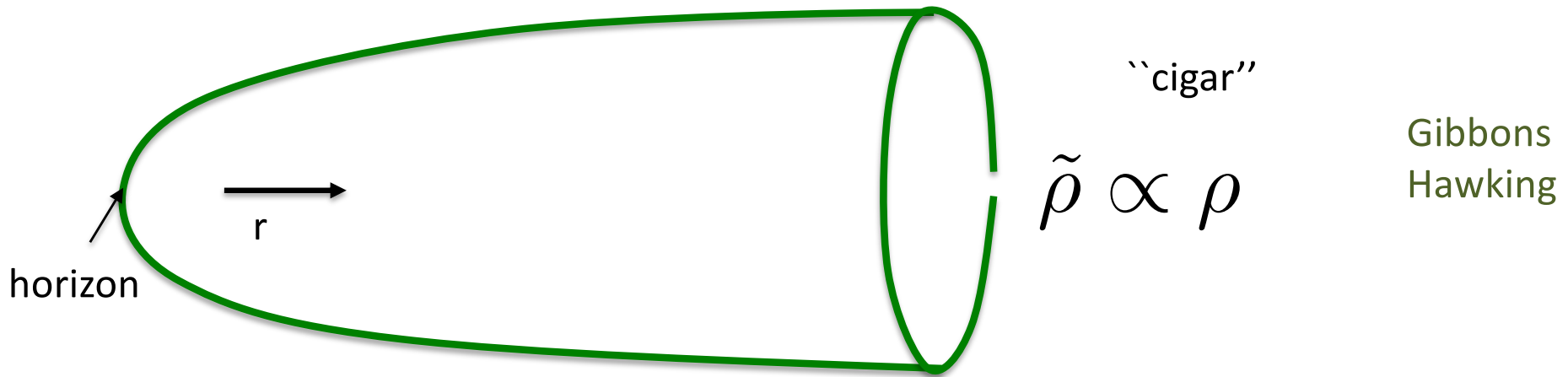

$$S = (1 - n\partial_n) \text{Tr}[\tilde{\rho}^n] \Big|_{n=1} = (1 - n\partial_n) \log Z_n \Big|_{n=1}$$

Computes the entropy if we can only compute the traces, but the actual density matrix itself

Other states prepared by a Euclidean functional integral.

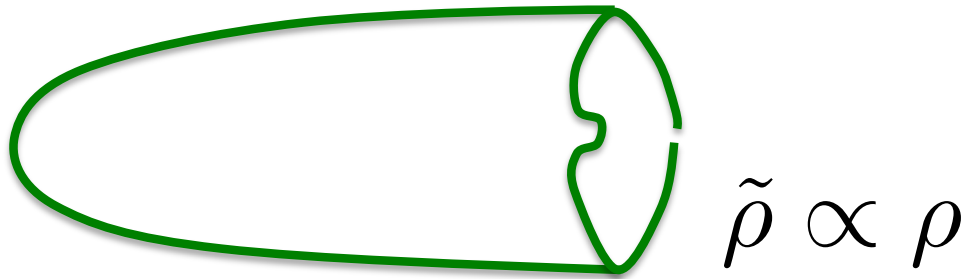

Lewkowycz, JM
 Faulkner, Lewkowycz, JM
 Dong, Lewkowycz, Rangamani
 Dong, Lewkowycz

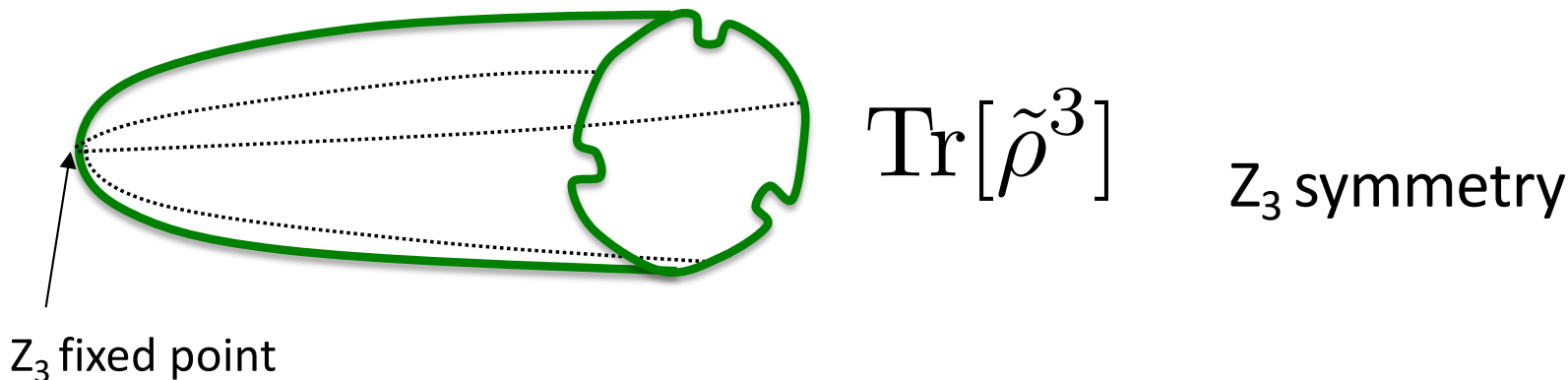

$$S = (1 - n\partial_n) \text{Tr}[\tilde{\rho}^n] \Big|_{n=1} = (1 - n\partial_n) \log Z_n \Big|_{n=1}$$

$$S = \min \left\{ \text{ext} \left[\frac{\text{Area}(X)}{4G_N} + S_{\text{semi-cl}}(\Sigma) \right] \right\} = \text{fine grained entropy formula}$$

- In the same way that the Euclidean black hole gives us the entropy, this replica trick gives us the gravitational fine-grained entropy formula.

- If the state is prepared by a Euclidean path integral and it has dynamical gravity only in some regions. Then we should allow various topologies in that region.
- Interiors connected by “replica wormholes”
→ island formula.

Penington, Shenker, Stanford, Yang
Almheiri, Hartman, JM, Shaghoulian, Tajdini

Replica wormholes: $n=2$

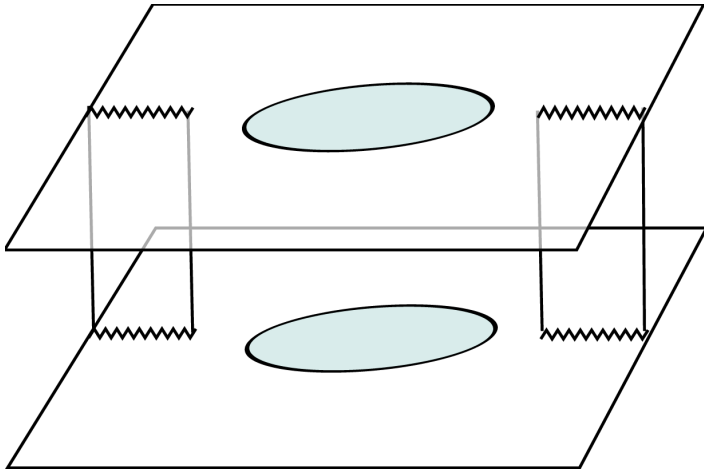

Solution that gives
Hawking's result

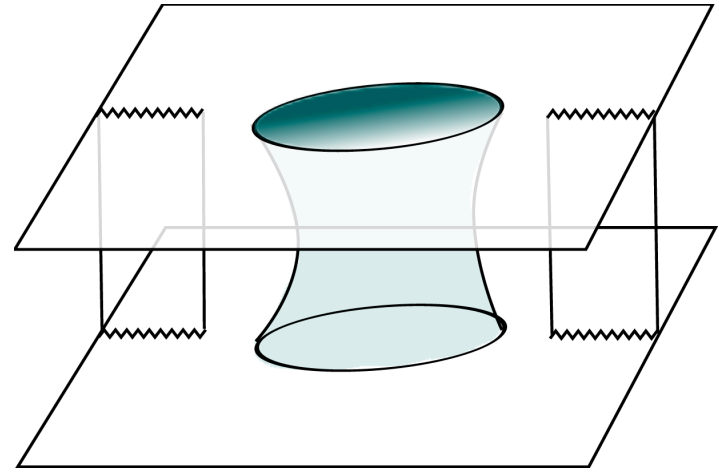

Replica wormhole, giving the
Page answer when it dominates
at late times.

The Hawking curve vs. the Page curve

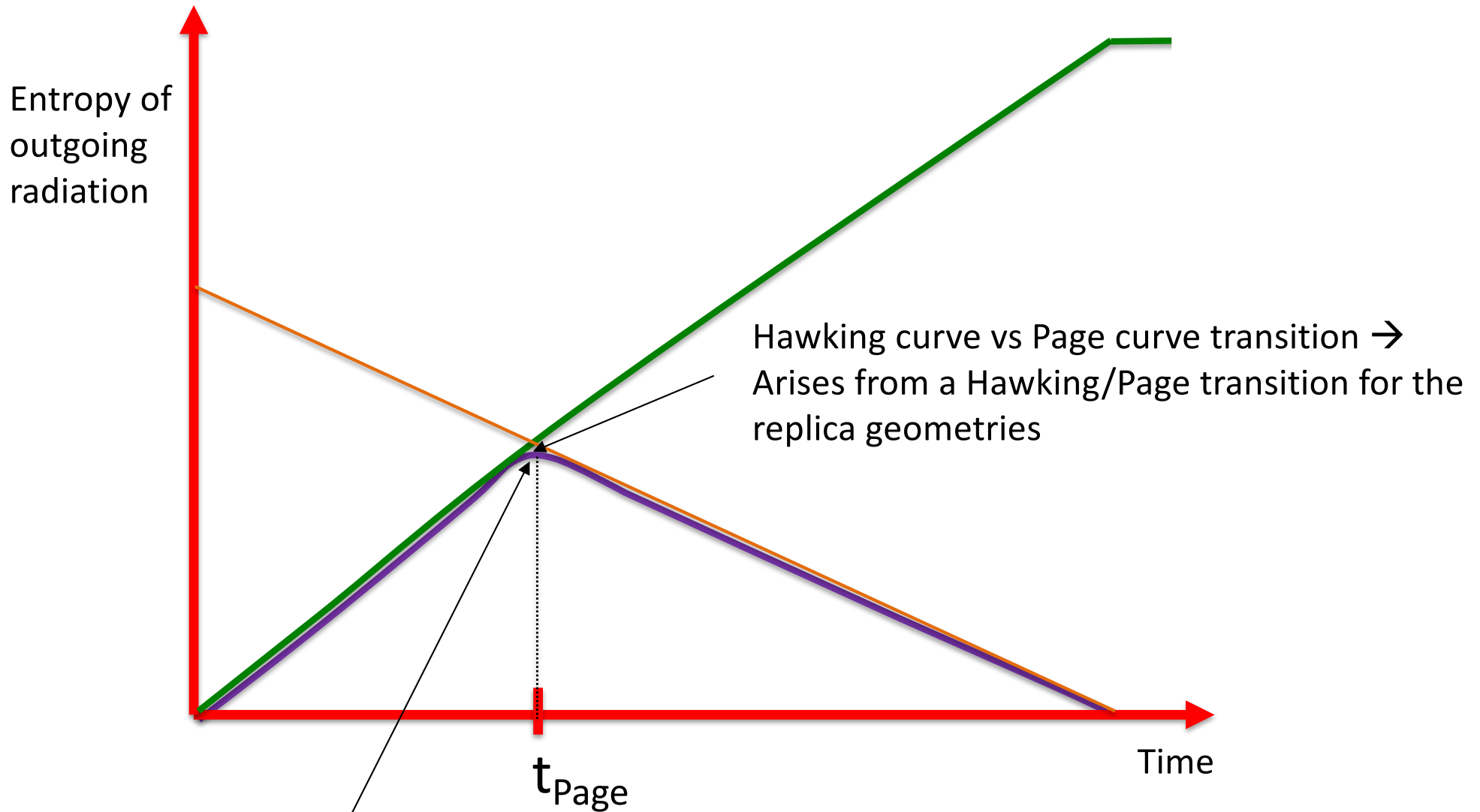

Gets smoothed out by considering the sum over non-replica symmetric geometries

Penington, Shenker, Stanford, Yang; Dong, H. Wang; Marolf, S. Wang, Z. Wang

- The Renyi entropies are given by these other non-trivial geometries. But the von Neuman entropy is given by a computation in the original semiclassical geometry.

So far, we only talked about entropy.

What is this telling us about the interior?

How do we describe the interior?

- The central dogma involves degrees of freedom that describe the black hole from the outside.
- What part of the interior do these degrees of freedom describe?
 - 1) All of the interior?
 - 2) None of the interior?
 - 3) Part of the interior? Which part?

before answering, let us introduce a
new concept

Entanglement wedge

- It is the causal domain of dependence of the region that appears in the computation of the entropy.

Czech, Karczmarek, Nogueira, Van Raamsdonk, Wall, Headrick, Hubeny, Lawrence, Rangamani

Examples

Entanglement wedge of the black hole in green. (black hole = quantum degrees of freedom describe the black hole from the outside)

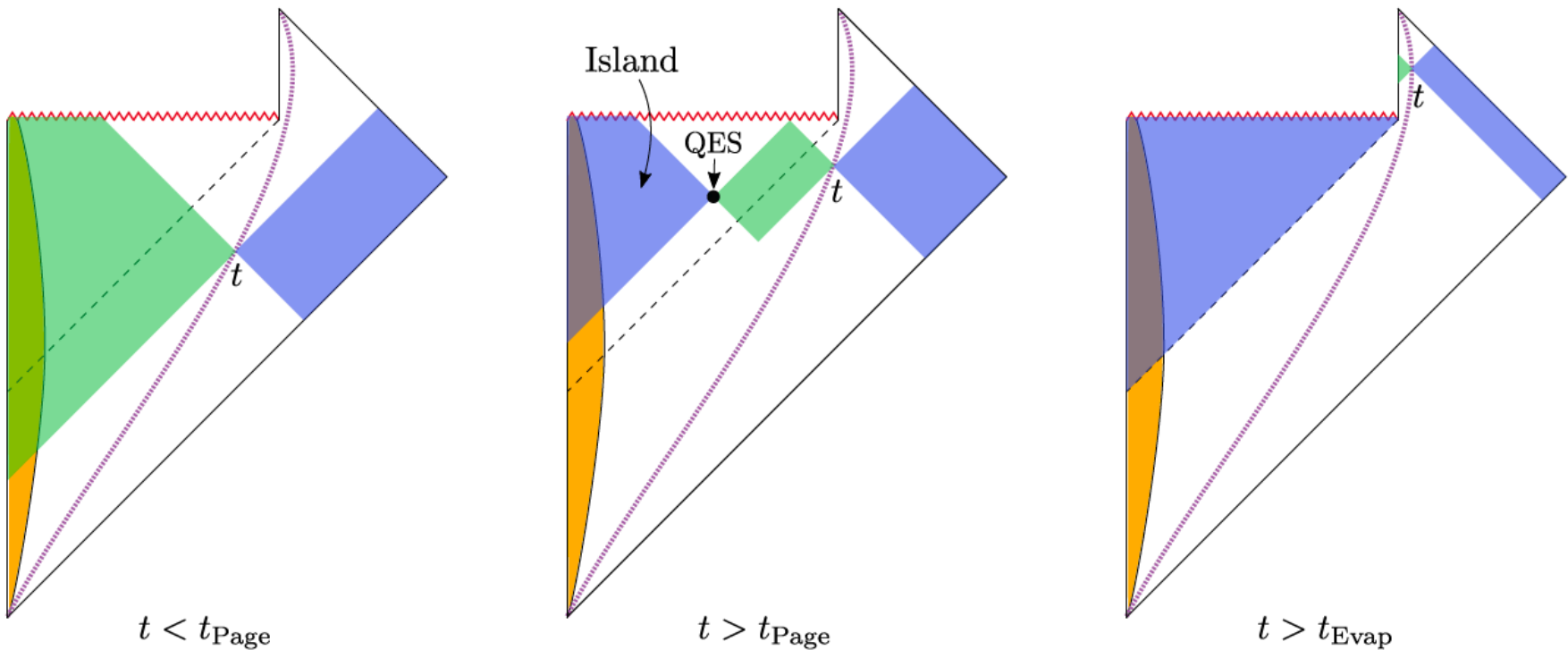

Entanglement wedge of radiation in blue.
(At late times, it includes part of the black hole interior)

Now the answer:

Entanglement wedge reconstruction hypothesis

- The quantum system describes everything that is included in its entanglement wedge.
- We can recover the state of a (probe) qubit inside the entanglement wedge.
- Recovery is state dependent (subspace dependent) and similar to quantum error correction.

Czech, Karczmarek, Nogueira, Van Raamsdonk, Wall, Headrick, Hubeny, Lawrence, Rangamani, Almheiri, Dong, Harlow, Jafferis, Lewkowycz, J.M., Suh, Wall, Faulkner....

Describing the interior

Part of the interior belongs to the black hole degrees of freedom and part to the radiation

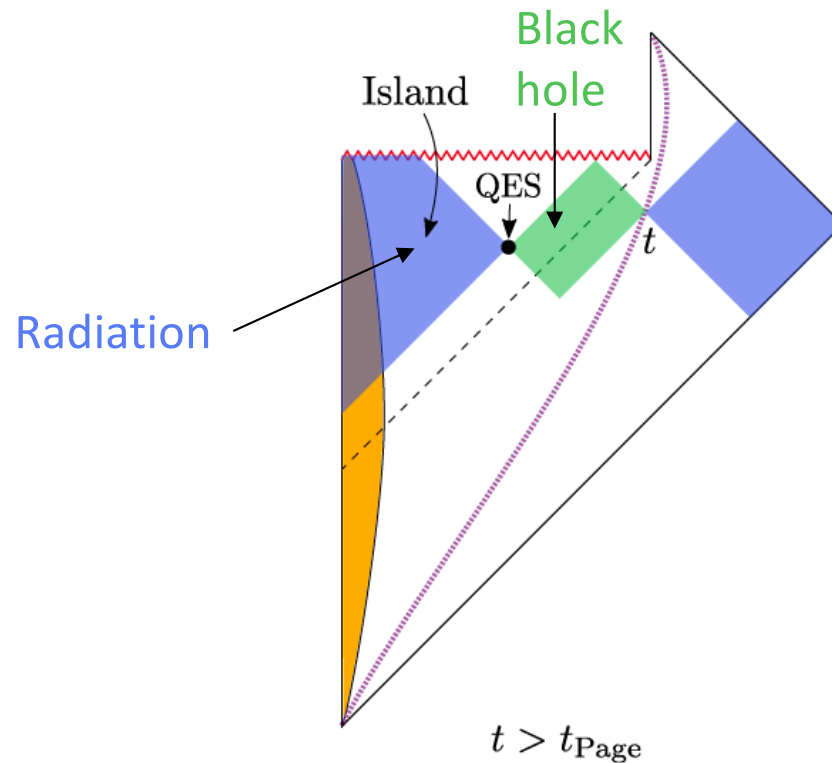

- By performing (a complicated) operation on the radiation \rightarrow we can extract information from the interior.
- How does this happen?
- The complicated operation creates a wormhole connection that connects to the interior and pulls the information from there.

Gao Jafferis Wall

Petz map: Almheiri, Dong, Harlow; Cotler, Hayden, Penington, Salton, Swingle, Walter; Chen, Penington, Salton; Penington, Stanford, Shenker, Yang

- Use the modular Hamiltonian, which can be non-local in the bulk.

Jafferis, Lewkowycz, JM, Suh; Almheiri, Anous, Lewkowycz;..., Y. Chen

The AMPS paradox

- The AMPS paradox involved the central dogma + one further implicit hypothesis:
- The interior operators act on the Hilbert space of the black hole, the same Hilbert space that appears in the central dogma.

The AMPS paradox

- The AMPS paradox involved the central dogma + one further implicit hypothesis:
- ~~The interior operators act on the Hilbert space of the black hole, the same Hilbert space that appears in the central dogma.~~

NO!

The AMPS paradox

- After the Page time, the troublesome interior mode is actually part of the radiation. It is in the entanglement wedge of radiation.

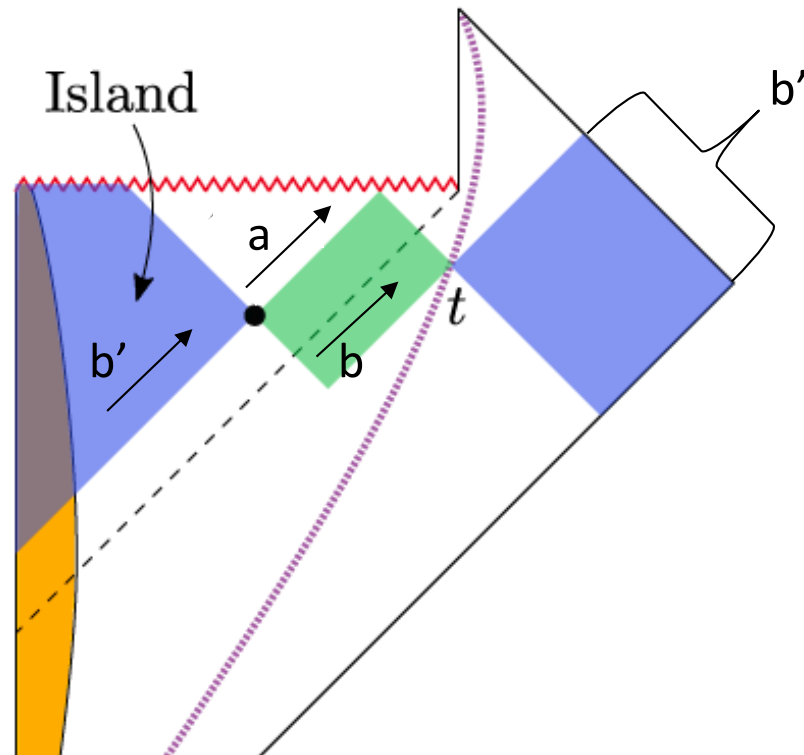

$$a=b'$$

Don't confuse the following two things

- 1) Quantum degrees of freedom that are necessary to describe the black hole from the outside. Sometimes also called "black hole degrees of freedom". (= all the dof of the "piece of coal").

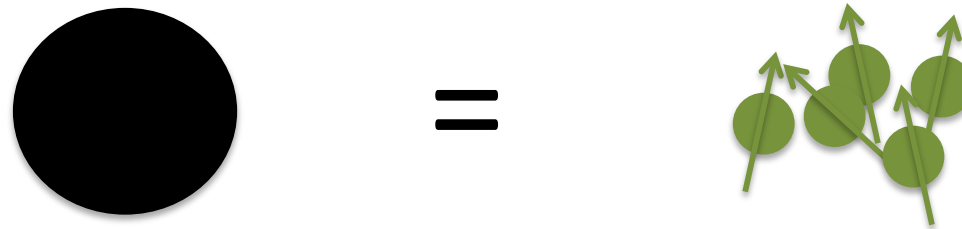

- 2) Quantum degrees of freedom in the black hole interior. Also sometimes called black hole degrees of freedom. Not the same as the degrees of freedom inside the piece of coal!

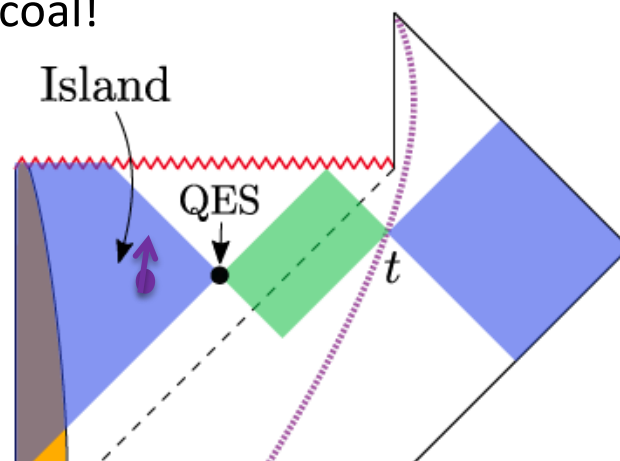

Ideas of quantum error correction, quantum complexity, are necessary to explain why a simple operation in the radiation does now affect a qubit in the interior.

Swingle; Almheiri, Dong, Harlow; Brown, Susskind, Kim, Tang, Preskill, + many others.....

comment

The entanglement wedge is a property of the state at some time t .

Horizons depend on the Hamiltonian and on what will happen in the future.

Suppose we decouple the two systems at the cutoff surface at time t . By evolving the black hole part differently we could recover the information behind the horizon that is in the **green region**. But we cannot recover the information that is in the **blue region** in the interior. Even if we decouple the systems, the blue and green regions would still be connected at the quantum extremal surface.

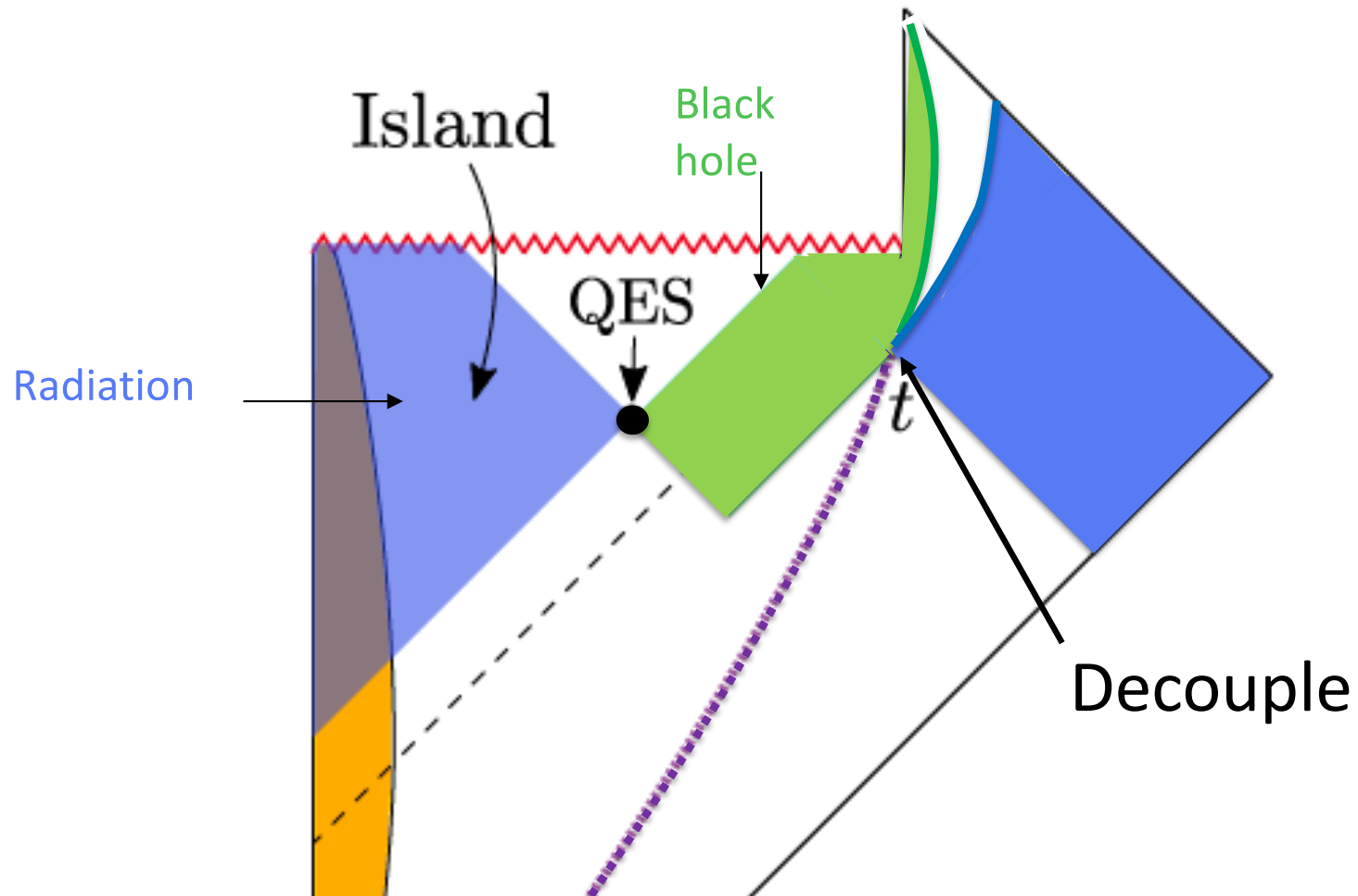

“Bags of Gold”

If there is a lot of entropy inside → the entanglement wedge of the black hole ends near the neck

Wall

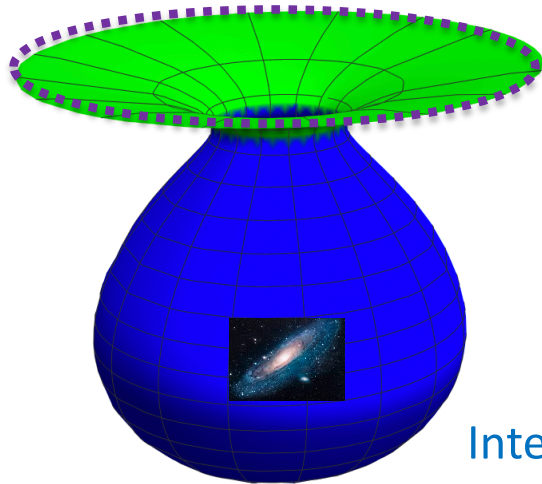

Interior of the bag belongs to somebody else...

Bag of gold vs old black hole

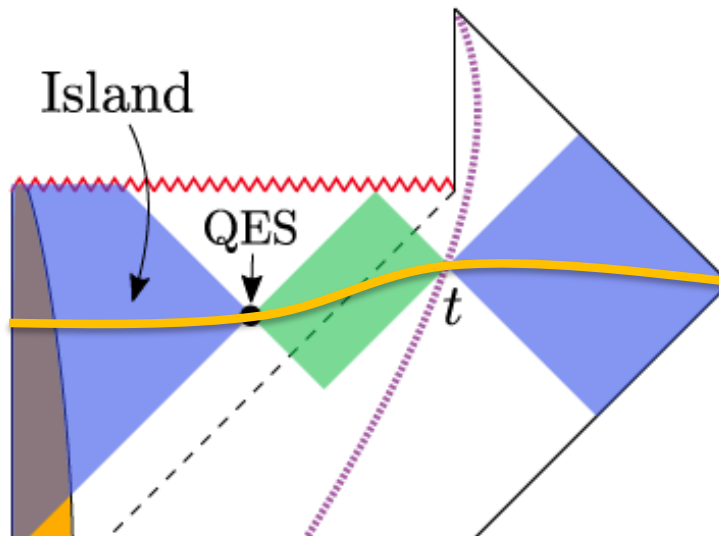

The geometry and entropy on the orange slice is somewhat similar to the bag of gold.

Conclusions

- We reviewed the gravitational fine-grained entropy formula.
- We applied it to the computation of the entropy of radiation and obtained results consistent with unitarity.
- At late times, most of the interior is part of the radiation. It is not part of the “black hole degrees of freedom”.

What was Hawking's mistake?

- Not to use the fine-grained entropy formula.

- A lot of what we discussed was derived by thinking about aspects of AdS/CFT, which itself involves string theory.
- But you only need gravity as an effective theory to apply these formulas.

There is an amazingly deep connection between gravity and quantum mechanics!

Is the information puzzle solved?

- One aspect: computing the entropy, yes.
- Another aspect: Understanding what the state is, no.
- Replica wormholes compute the entropy, but do not tell us what the actual state is.
- As with black hole entropy, it is an accounting “oracle”. The explicit gravitational representation of the states is still mysterious. But the semiclassical solution is representing some aspects of the state.

Another aspect of the information problem

- There is a form of the information paradox that involves corrections to the long time behavior of correlators.
- Corrections due to the discreteness of the energy eigenvalues and the finiteness of the entropy.

Long times

Saad, Shenker, Stanford

- A particular feature, “the ramp”, was understood in terms of a wormhole geometry.
- Averages (over couplings) are important for this result.

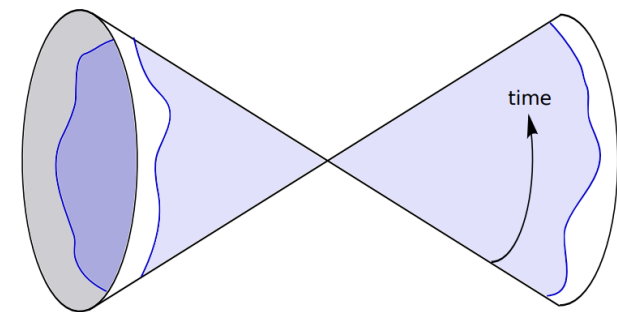
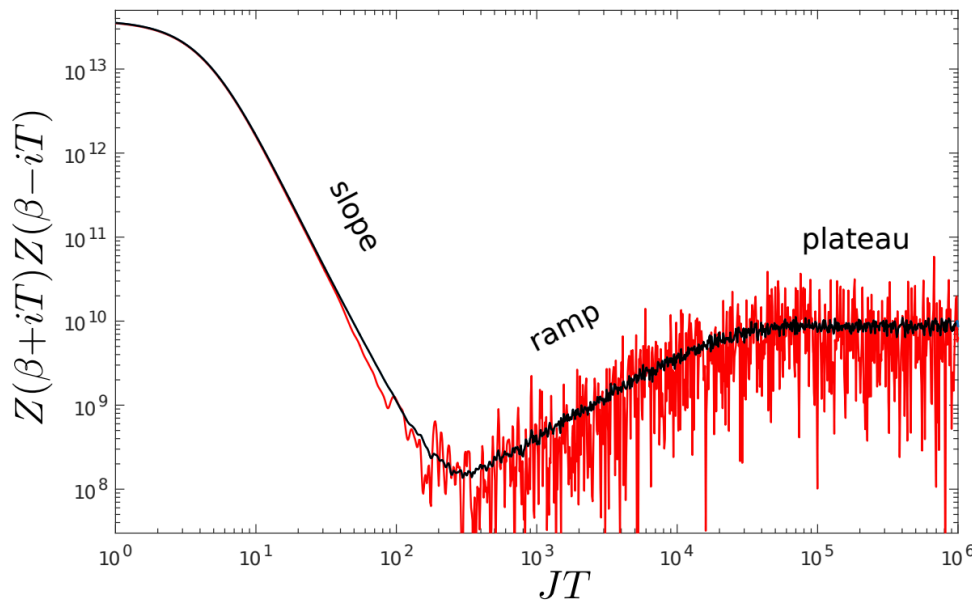

JT gravity from random Hamiltonians

- JT gravity was interpreted as arising when we average over Hamiltonians.
- A new view on the random matrix/string theory connection. A new interpretation for the matrix.

Random couplings

- The idea that random couplings give rise to geometric connections and wormholes was suggested in the past.

Coleman; Giddings, Strominger
Polchinski, Strominger

- These ideas are being revisited.

Marolf, Maxfield; Giddings, Turiaci; ...

- What role do they play in AdS/CFT ?

Future

- What further lessons is this teaching us about the interior? The singularity ?
- Implications for cosmology ?

Thank you !

