



International Workshop  
FIRST RESULTS FROM THE LHC  
AND  
THEIR PHYSICAL INTERPRETATION  
19-21 OCTOBER 2010,  
PROTVINO, RUSSIA

# Performance of the ATLAS Transition Radiation Tracker with Cosmic Rays and First High Energy Collisions at LHC



Ruslan Mashinistov  
P.N. Lebedev Institute of Physics (FIAN)  
On behalf of the ATLAS TRT Collaboration



P.N. Lebedev Physical  
Institute of the Russian  
Academy of Science

# Outline

**TRT = Transition Radiation Tracker**

- TRT in ATLAS Inner Detector
- TRT Design
- Timeline
- Principles of Operation
- TRT R-T dependency
- TRT Performance
- Fast-OR Cosmics trigger
- Summary

# TRT in ATLAS Inner Detector

The TRT is the outermost and largest of the three sub-systems of the ATLAS Inner Detector. It is designed to operate in the 2T solenoidal magnetic field at the LHC design luminosity ( $L = 10^{34} \text{cm}^2 \text{s}^{-1}$ ).

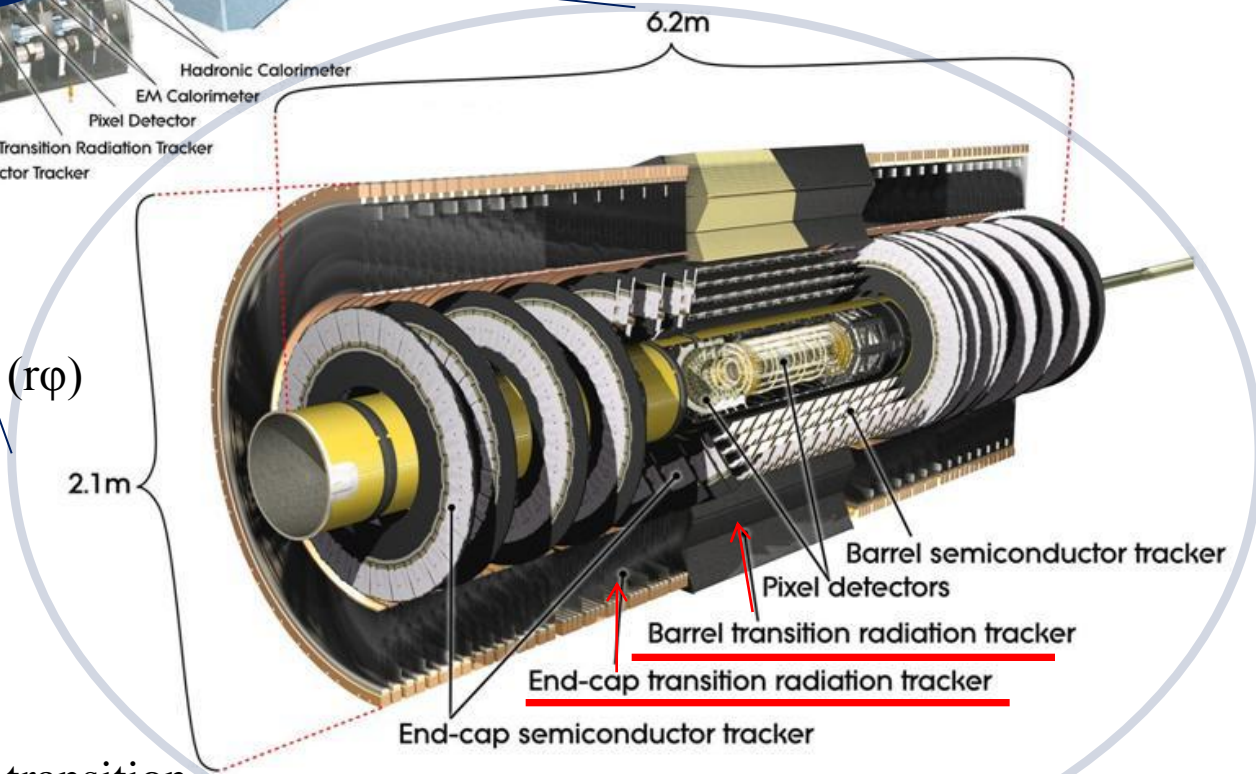
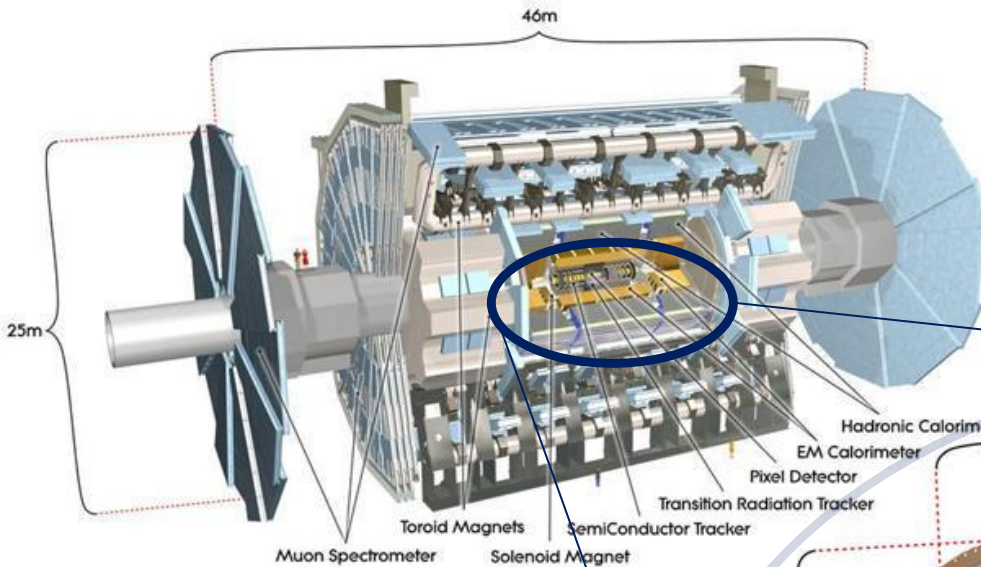

## TRT detector:

- ~0.4 M channels
- Single hit resolution:  $\sim 130 \mu\text{m}$  ( $r\phi$ )
- Momentum resolution:  
 $\sigma(p_T)/p_T = 0.05\% p_T \oplus 1\%$
- TRT geometry gives  $\sim 30$  two-dimensional spacepoints for charged particles with  $|\eta| < 2$  and  $p_T > 0.5 \text{ GeV}/c$
- $e^\pm$ -Particle ID by detection of transition radiation  $\gamma$  with  $|\eta| < 2$  and  $p > 1 \text{ GeV}/c$

# TRT Design

The TRT is made of thin-walled straw drift tubes with a single hit design resolution of  $130\ \mu\text{m}$ .



Two 9.5mm wide strips of coated polyimide film spirally wound back-to-back with a  $50 \pm 10\%$  overlap

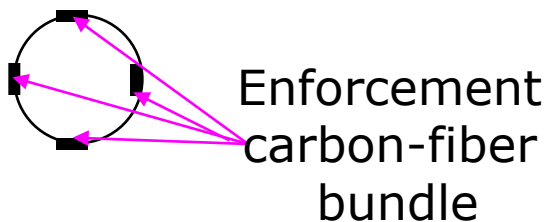
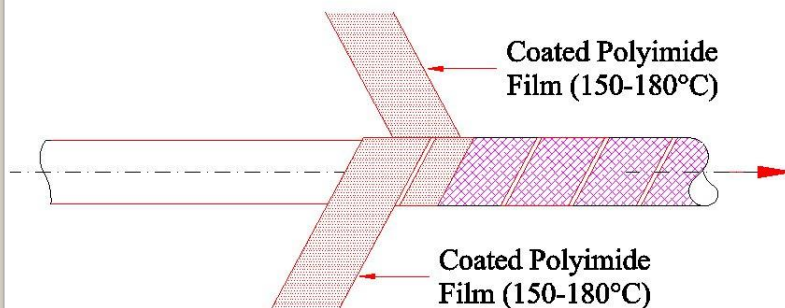

- The straw is made by spirally winding and fusing 2 bands of aluminized kapton.
- The aluminized surface is protected by a carbon-polyimide coating.
- The outside surface of straw is laminated with 4 bundles of carbon-fiber filament to improve electrical/thermal conductivity and mechanical strength.
- The straw tubes are 4 mm diameter with a  $31\ \mu\text{m}$  diameter gold plated tungsten anode wire in the center.
- The wires are in individual gas envelopes
- The straws work in proportional mode with a  $-1.5\ \text{kV}$  potential in the straw wall with respect to the wire that is held at ground.

# TRT Design

The TRT consists of three parts, a barrel and two end-caps.

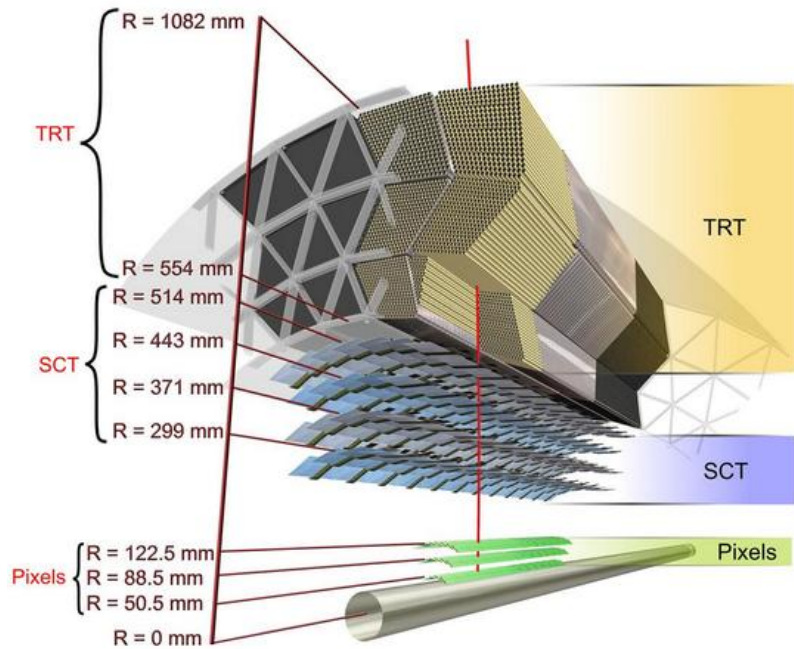

## TRT Barrel:

- The Barrel covers  $|\eta| < 1$
- 52544 straws 1.44 m in length are oriented parallel to beam axis
- Wires electrically split in the middle to reduce occupancy (1.5 cm dead region)

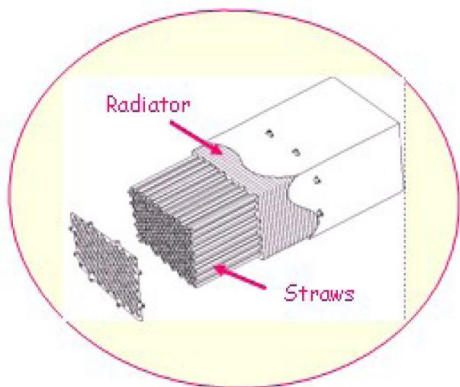
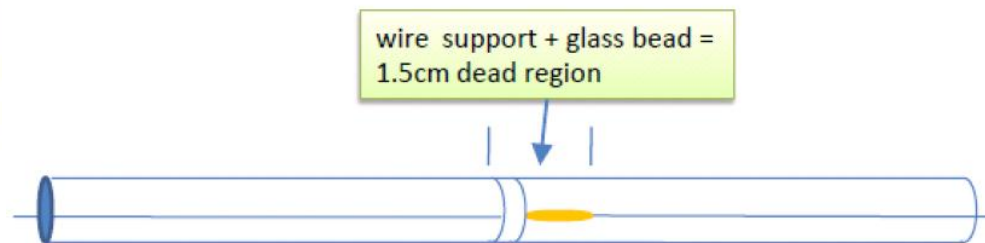

- Each straw has an independent readout on both ends
- The straws are arranged in 3 layers of 32 modules each
- The transition radiator material which completely surrounds the straws inside each module consists of polypropylene-polyethylene fiber matting.
- 105088 readout channels



# TRT Design

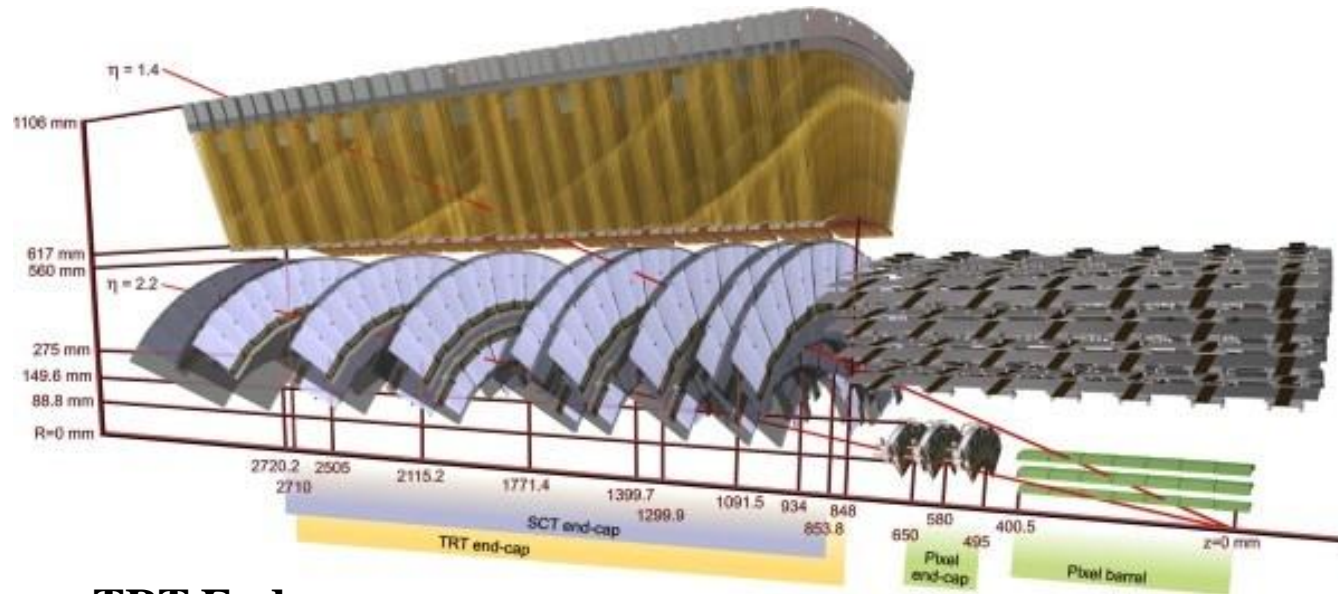

## TRT End-caps:

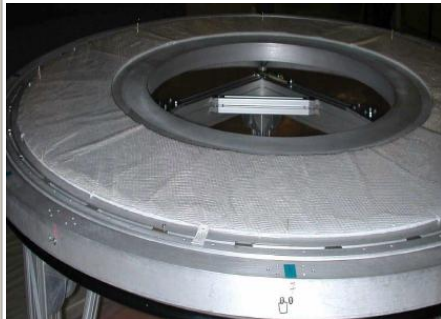

End-cap radiator

- The two end-caps cover the region:  $1 < |\eta| < 2$
- Each end-cap contains 122880 straws 39 cm in length radially aligned to the beam axis
- 20 wheels with 8 straw Layers
- The TRT end-cap radiators are disk-shaped stacks of alternating layers of thin plastic film and sheets of a spacer fabric
- 122880 readout channels

# TRT Design

- Accurate pT measurement in conjunction with the Si tracking detectors:
  - Long arm needed
  - Many hits (30-40 TRT hits per track)
  - Impact of TRT on Pt resolution measured in Cosmics and collision data
- Provide Electron Identification
- Very high occupancy: up to 30%
- Very high counting rate: up to 20 MHz/straw
  - Time between bunch crossings: 25 ns
- Minimal amount of material (in radiation lengths)
- Hard radiation environment
  - ~10MRad
  - ~ $10^{14}$  n/cm<sup>2</sup> year
- Fast and chemically passive straw gas: ageing
- Chemically resistant straw materials
- Extremely precise and robust mechanical structure
  - Tolerances <30  $\mu$ m
- Temperature stability: cooling

# Timeline

**1988: Initial paper published on TRT concept**

**1989: R&D for the TRT begins (1990: RD6)**

**1994: LHC machine approved. First full-size TRT prototype completed (10'000 channels for end-cap wheel)**

**1996-1998: Major Technical Design Reports for ATLAS construction approved**

**1998: ISTC project #441**

**2000: Assembly of Barrel modules and end-cap wheels starts**

**Front-end electronics specified and vendor chosen**

**2001: ISTC project #1800**

**2006: First cosmic track recorded**

**2006: Installation of Barrel ID in ATLAS cavern**

**2007: Installation of ID end-caps in the cavern**

**2008: TRT routinely operated**

**Various Milestones Cosmic runs**

**September 10th: first LHC beam seen (beam splashes)**

**2009: Stable operation**

**Spring/Summer Cosmic Combined runs**

**October ATLAS 24/7 operation first collisions at  $\sqrt{s}=900$  GeV**

**2010: Stable 24/7 operation**

**first high energy proton collisions  $\sqrt{s}=7$  TeV**



# Timeline

## 1988: Initial paper published on TRT concept

CERN 88-02  
22 April 1988

ORGANISATION EUROPÉENNE POUR LA RECHERCHE NUCLÉAIRE  
**CERN** EUROPEAN ORGANIZATION FOR NUCLEAR RESEARCH

### THE FEASIBILITY OF EXPERIMENTS AT HIGH LUMINOSITY AT THE LARGE HADRON COLLIDER

Report of the High-Luminosity Study Group  
to the CERN Long-Range Planning Committee

Edited by J.H. Mulvey

GENEVA  
1988

### ESTIMATE OF A TRANSITION RADIATION DETECTOR'S PERFORMANCE AS PART OF AN ELECTRON IDENTIFICATION SCHEME

T. Åkesson, C.W. Fabjan, F. Sauli and J. Schukraft,  
CERN, Geneva, Switzerland  
V. Chernjatin and B. Dolgoshein,  
Institute of Moscow Engineering Physics, Moscow, USSR

In this discussion of electron identification, it will be assumed that the starting point is an electron candidate, i.e. an electromagnetic (e.m.) shower seen in a calorimeter, and an interaction position; this could be known either through a vertex detector or by the calorimeter's capability of pointing the e.m. shower to the beam line. If the centroid of the e.m. shower is determined with a 1 mm precision in two layers separated by 100 mm, a sufficiently narrow road could be defined. The capacity of the calorimeter alone to identify electrons will not be discussed here. It has been demonstrated [1] that a hadron rejection of  $10^2$  to  $10^3$  can be achieved, with a 95% electron efficiency, by requirements on longitudinal and lateral shower development. In this note improvements are studied which can be achieved by equipping the region between the calorimeter and the interaction region.

Ideally, this region should be equipped with a tracking detector having a spatial resolution equal to the width of the path defined by the shower and vertex position, which is about a millimetre. In addition, this tracking detector should be as efficient as possible for electrons and as inefficient as possible for hadrons, e.g. a transition radiation detector (TRD). Here it is important to bear in mind that the role of the TRD is to reject hadrons that are in another momentum range than that of the electrons, since the predominant background is an e.m. shower from an energetic  $\pi^0$  in spatial coincidence with low-energy charged hadrons. Consequently, the optimization of the TRD depends more on these low-energy hadrons than on the energy range of the electrons to be measured. The TRD can thus be made compact.

Transition radiation detectors can be operated in two different modes [2]: i) total ionization measurement, and ii) cluster counting. In the first method the total combined signal of ionization and X-rays is measured in the X-ray absorption gap. The background here comes from the Landau-distributed fluctuations in  $dE/dx$ . In the second method the number of energy deposits above a given threshold, i.e. the number of TRD quanta, is counted. Here the background is the Poisson-distributed number of  $\delta$ -rays. The second method provides somewhat better hadron rejection, and more importantly uses simpler electronics and lends itself to fast-trigger applications.

In this discussion we will consider the cluster-counting method in a TRD of the type described in Ref. [2]. This detector, shown in Fig. 1, consists of a large number of radiator-proportional chamber (PC) sets. Each radiator is about 1 cm thick and consists of 40 polypropylene foils, each foil being 18  $\mu\text{m}$  thick. The PC is 3 mm thick and has a wire spacing of 2 mm. The chamber gas is a mixture of xenon (60%) and helium (35%), with methane (5%) as the quencher.

The single-particle response of such a TRD is shown in Figs. 2 and 3. Figure 2 shows the rejection,  $R = \epsilon_e/\epsilon_c$ , as a function of the detector length for 50 GeV particles and a requirement of 90% electron efficiency. The rejection varies strongly with the length of the TRD, and we have taken 40 cm (5% of a radiation length) as a figure for the further discussion. This choice is not completely *ad hoc*, since our background will be of a combinatorial nature, and we will

# Timeline

- 1988:** Initial paper published on TRT
- 1989:** R&D for the TRT begins (1990)
- 1994:** LHC machine approved. First channels for end-cap wheel
- 1996-1998:** Major Technical Design
- 1998:** ISTC project #441
- 2000:** Assembly of Barrel modules and Front-end electronics specified and
- 2001:** ISTC project #1800
- 2006:** First cosmic track recorded
- 2006:** Installation of Barrel ID in ATLAS
- 2007:** Installation of ID end-caps in ATLAS
- 2008:** TRT routinely operated

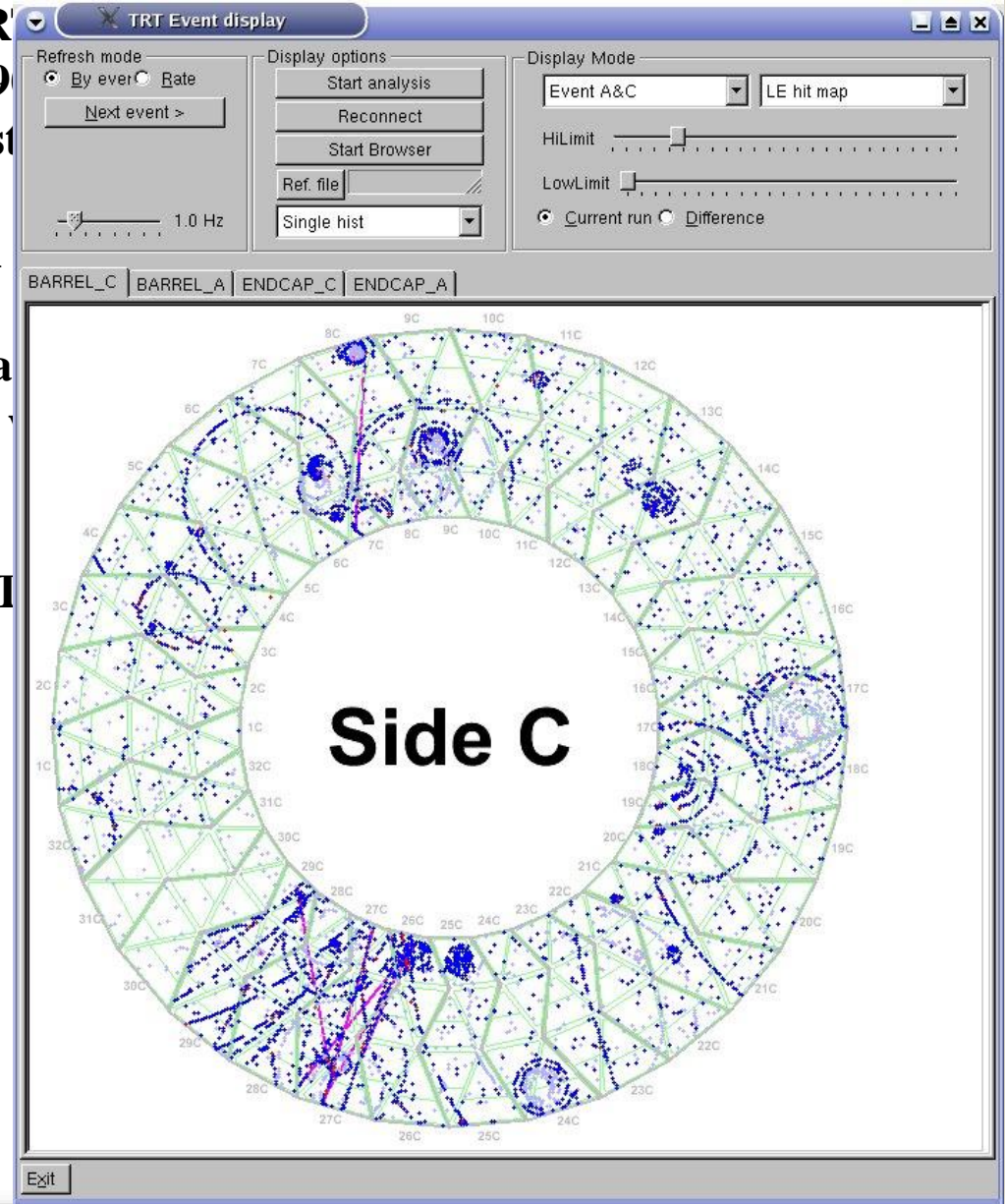

# Timeline

**1988: Initial paper**

**1989: R&D for the**

**1994: LHC machine  
channels for end-**

**1996-1998: Major**

**1998: ISTC project**

**2000: Assembly of**

**Front-end electronics**

**2001: ISTC project**

**2006: First cosmic**

**2006: Installation**

**2007: Installation**

**2008: TRT routine**

**Various Milestones**

**September 10th:**

**2009: Stable operation**

**Spring/Summer Cosmic Combined runs**

**October ATLAS 24/7 operation first collisions at  $\sqrt{s}=900$  GeV**

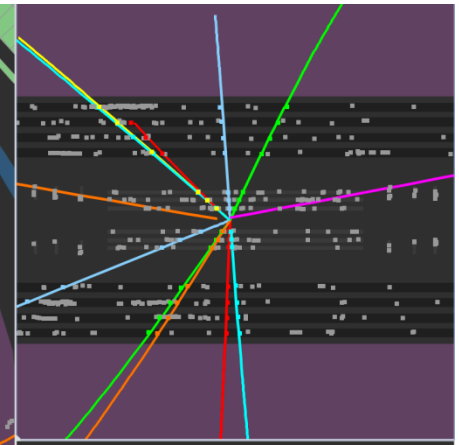
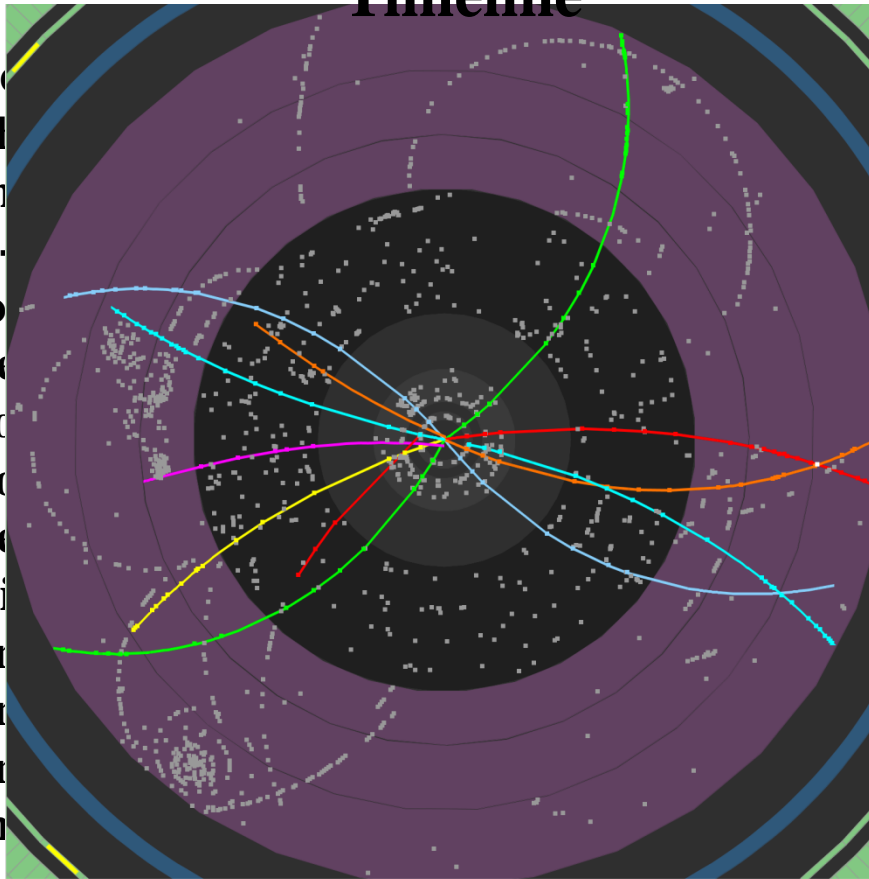

**ATLAS  
EXPERIMENT**

2009-12-06, 10:04 CET  
Run 141749, Event 406601

**Collision Event**

<http://atlas.web.cern.ch/Atlas/public/EVTDISPLAY/events.html>



# Timeline



Run Number: 154817, Event Number: 968871

Date: 2010-05-09 09:41:40 CEST

$M_{ee} = 89 \text{ GeV}$

$Z \rightarrow ee$  candidate in 7 TeV collisions

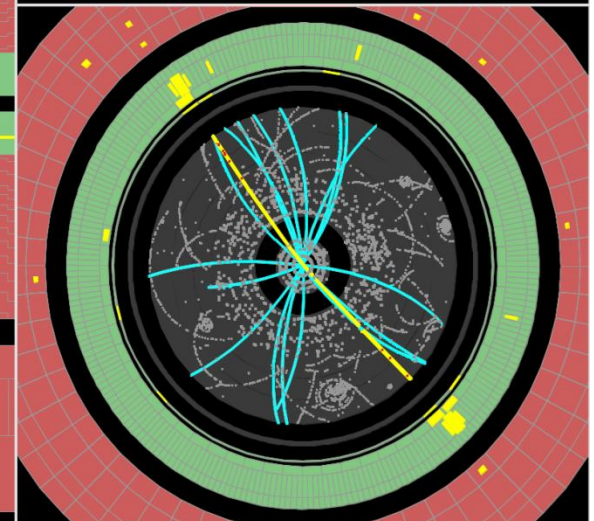
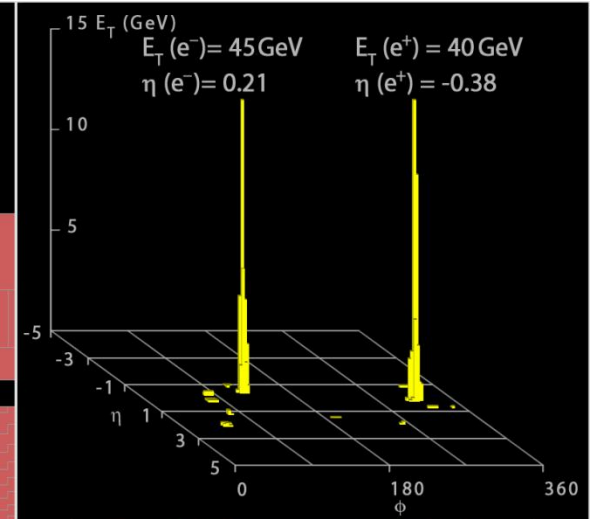
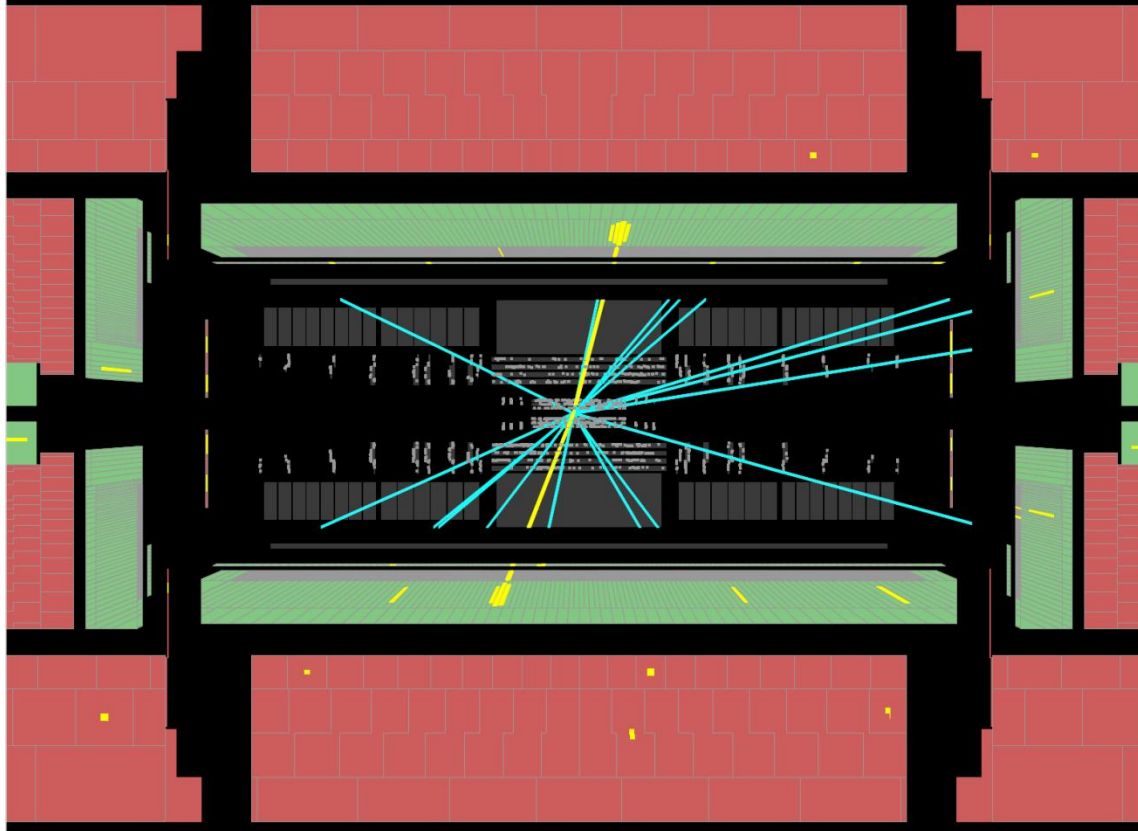

**2010: Stable 24/7 operation**

**first high energy proton collisions  $\sqrt{s}=7 \text{ TeV}$**

# Principles of Operation

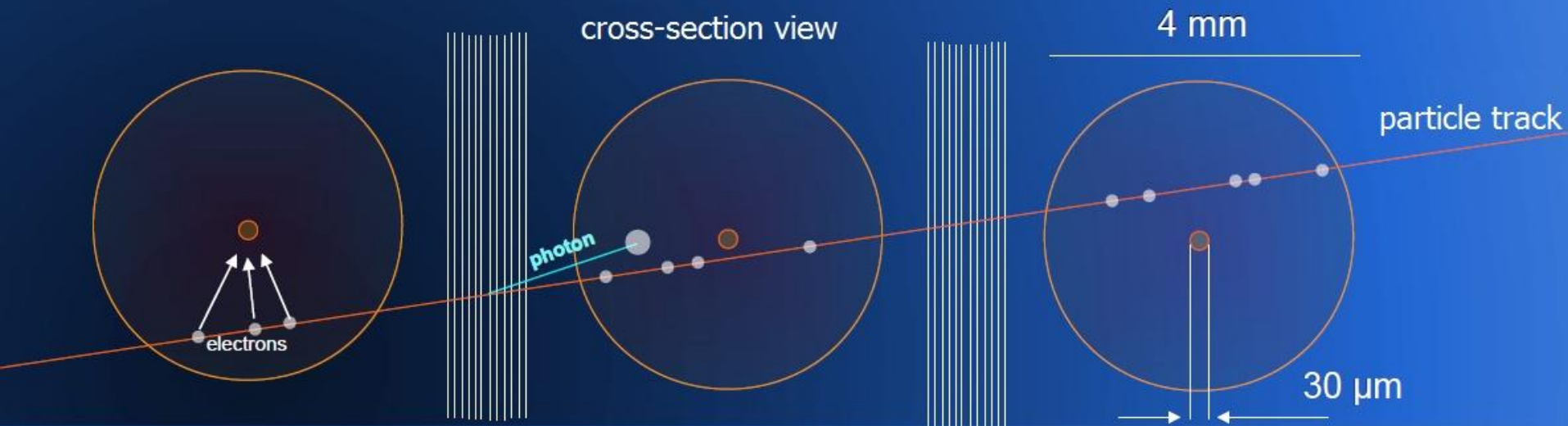

• 4 mm straws with drift time ( $T_{\text{Drift}}$ ) measurements for increased spatial resolution

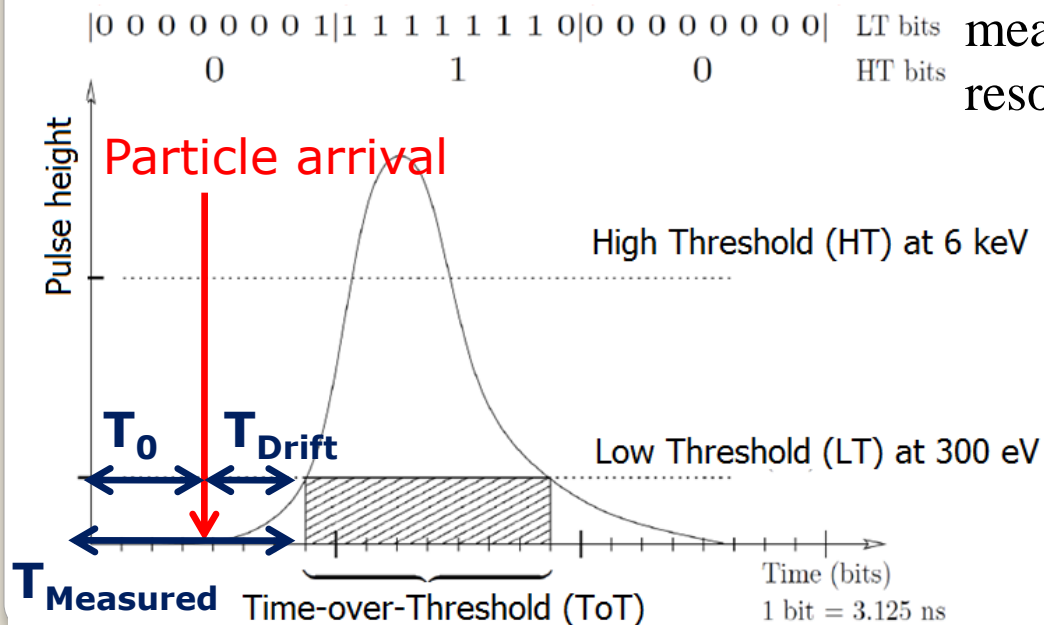

- The measured drift time depends on the the position along the straw, gas density, threshold setting,...
- Need to be converted in distance with a proper R-t relation (drift radius)
- R-t relation is straw dependent and time dependent



# Principles of Operation

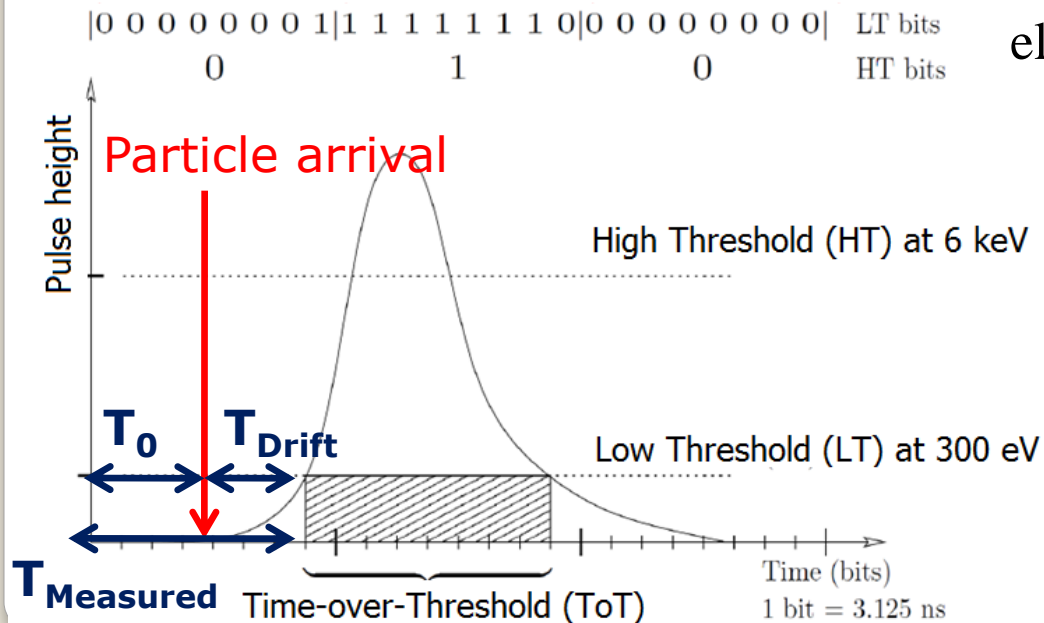
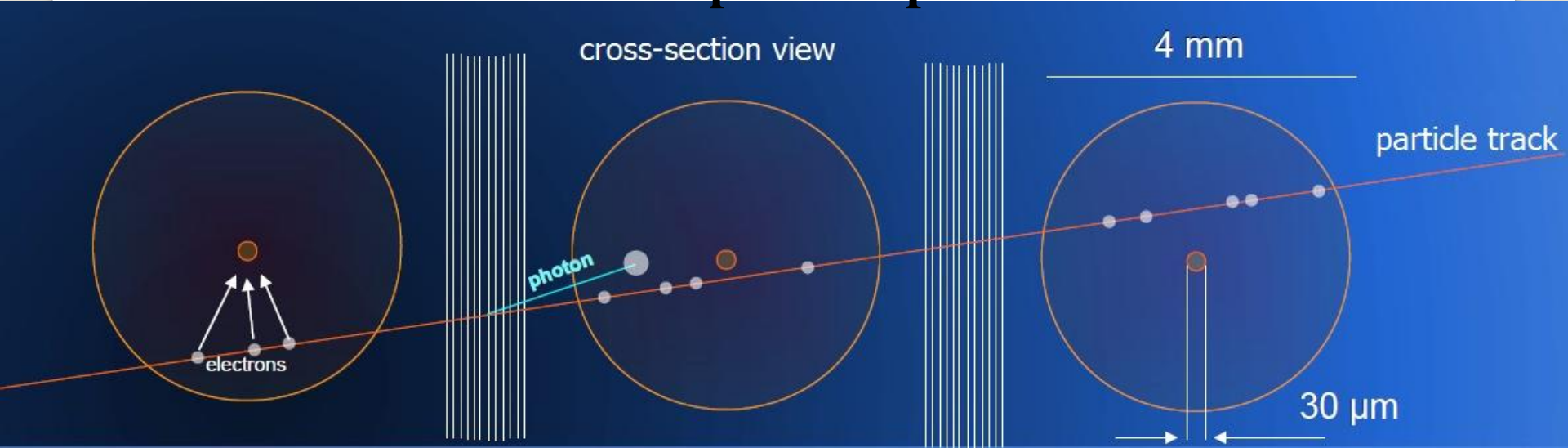

- $T_0$  depends on ToF, cable lengths, electronics delays, etc.

- Different for each straw
- May change from run to run
- calibrated every 24 h

# TRT R-T dependency

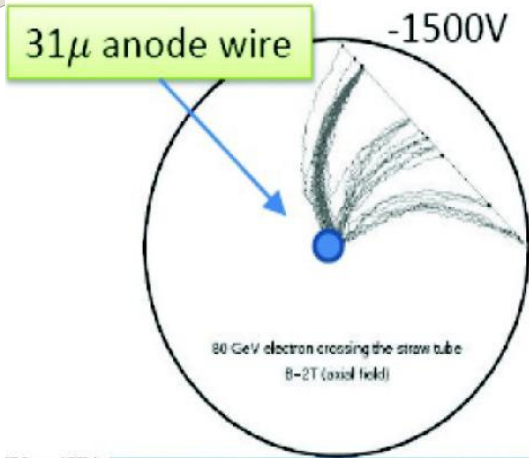

- Converts  $T_{\text{Drift}}$  to distance measurement used in tracking
- Gas composition, gas conditions and magnetic field dependent
  - Can change with time and from straw to straw
- Calibrated every 24 h
  - proved to be very stable
  - same performance 900GeV/7TeV
  - One R-t fit is used for all TRT straws

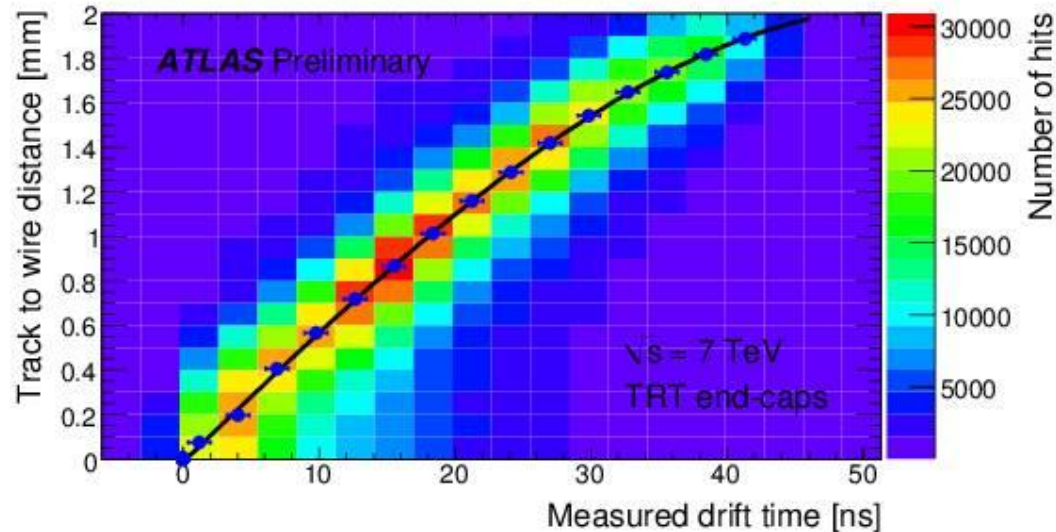
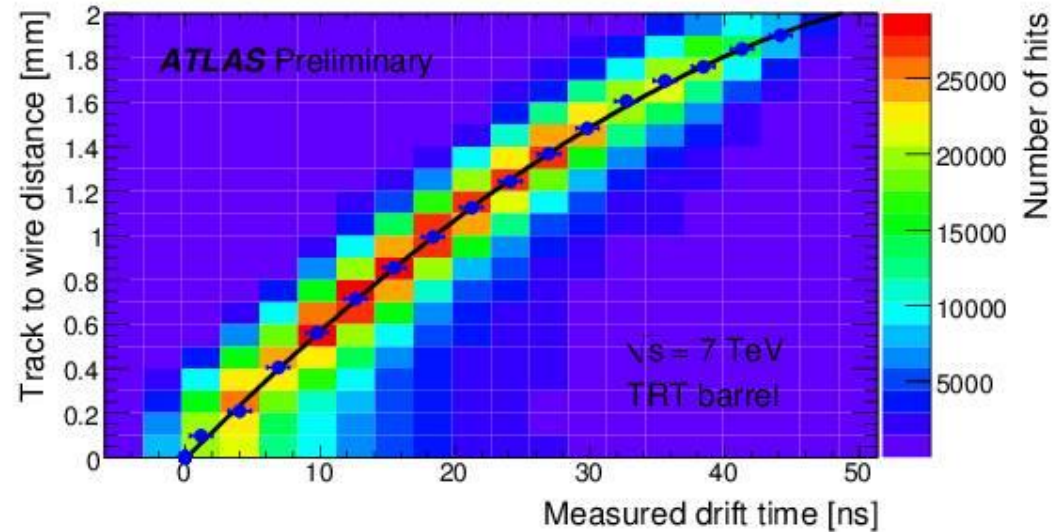

# TRT Performance - Resolution

- During cosmic runs a good understanding of the Barrel was achieved
- Cosmic rays measurements did not allow to study end-caps in detail. Further analysis and alignment is required to achieve similar performance as the Barrel
- The 7 TeV data taken with the post-collision alignment (using 2009 cosmics+ 900 GeV data) is improved compared to pre-collisions Alignment (using 2008 cosmics), but still differs in end-caps from Monte-Carlo simulations with perfect geometry

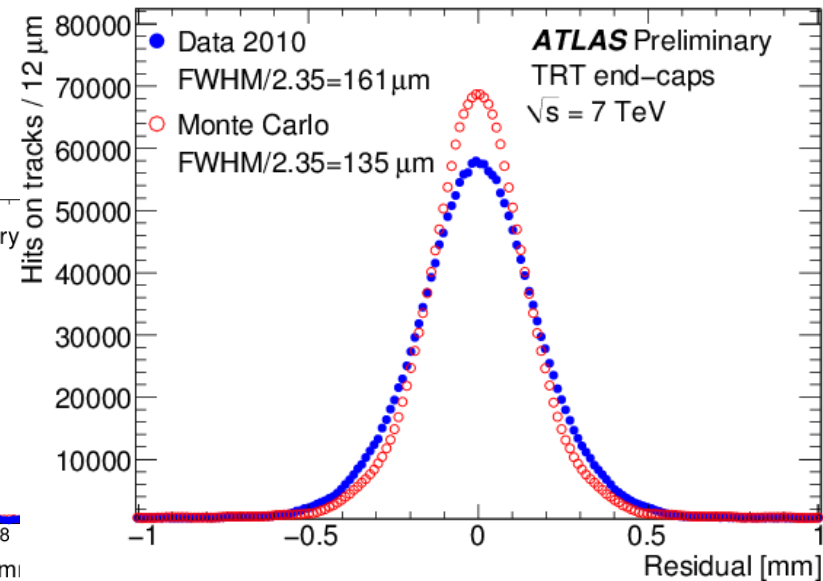
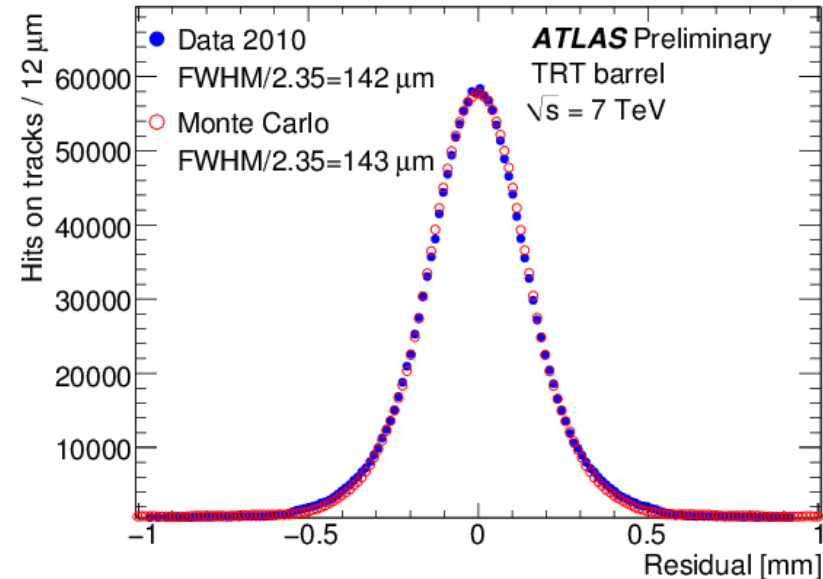
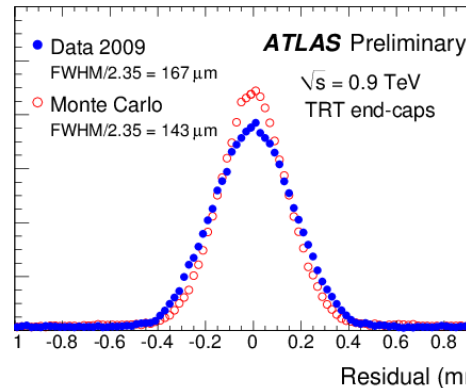
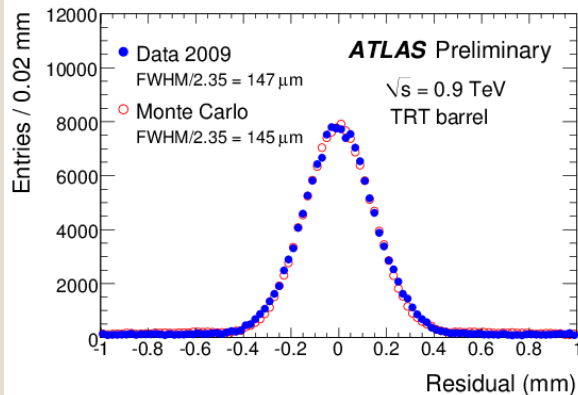

# TRT Fast-OR Cosmics Trigger

The TRT “Fast-OR” trigger is the highest rate cosmic-ray trigger of the ATLAS Inner Detector. It uses a fast trigger generation circuit on the front-end electronics and a simple trigger logic circuit on the TRT trigger, timing and control board.

## TRT front-end electronics

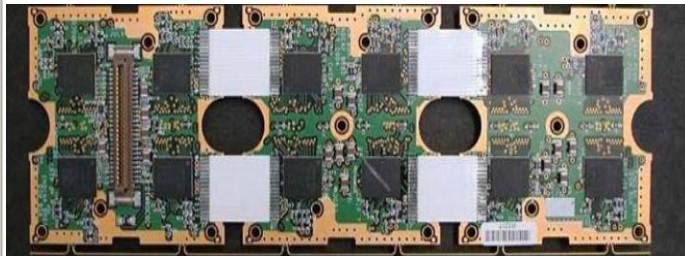

← End-cap digital

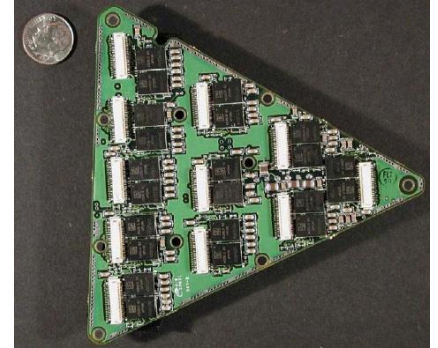

Barrel analog →

The custom made radiation-hard TRT frontend electronics implements a two threshold algorithm to discriminate the signals: a low threshold ( $<300$  eV) for registering the passage of minimum ionizing particles, and a high threshold ( $>6$  keV) to flag the absorption of transition radiation X-rays.

It consists of analog and digital chips, mounted in Barrel on the opposite sides of PCB and in End-caps – on separate PCBs located on top of each other. TRT readout chipset:

- ASDBLR – “Amplifier Shaper Discriminator Baseline Restorer” – analog integrated circuit
- DTMROC – “Digital Time Measurement Readout Chip” – digital integrated circuit



## TRT Fast-OR Cosmics Trigger

- **Motivation:**

- High good-track rate in standalone and combined running
- Enhance track rate in the end-cap region
- Independence from other systems

- After Sept.2008 LHC incident -> **decision to finalize the trigger**

- **Configuration:** use DTMROC high threshold signals lowered to MIP levels

- Implementation was quick: first tracks – end Oct.2008, timing-in completed May 2009

- The number of recorded cosmic muons tracks was doubled in just a week

### **Data from the June 2009 combined run with the full Inner Detector shows:**

- Total TRT barrel trigger rate of 8 Hz on cosmics tracks with a track purity from offline reconstruction of 98%. The endcap trigger rate is 13 Hz.

- Using tracks triggered by the Calorimeters, the trigger efficiency in the barrel is estimated to be 75%.

- Very good trigger timing jitter of 9 ns

- Trigger rate ~10 Hz with a high purity of >90% events with tracks

- Became a major player in ATLAS commissioning:

- reference trigger for timing-in of other ATLAS triggers



# TRT Fast-OR Cosmics Trigger

**Example of an event display with a track from a cosmic ray traversing the detector.**

Each straw that exceeded the HT (red straws) contributes to the trigger signal. The trigger granularity is roughly one green-bordered segment (one TTC line with 200 straws). Each red-bordered segment contributes to the trigger decision. A set of 9 such segments makes a “phi sector” (  $1/32$  in azimuth), labeled from 1 to 32 in the Figure. The trigger logic comprises 4 adjacent phi sectors (36 TTC lines) and was configured to generate a trigger if there are at least four red segments.

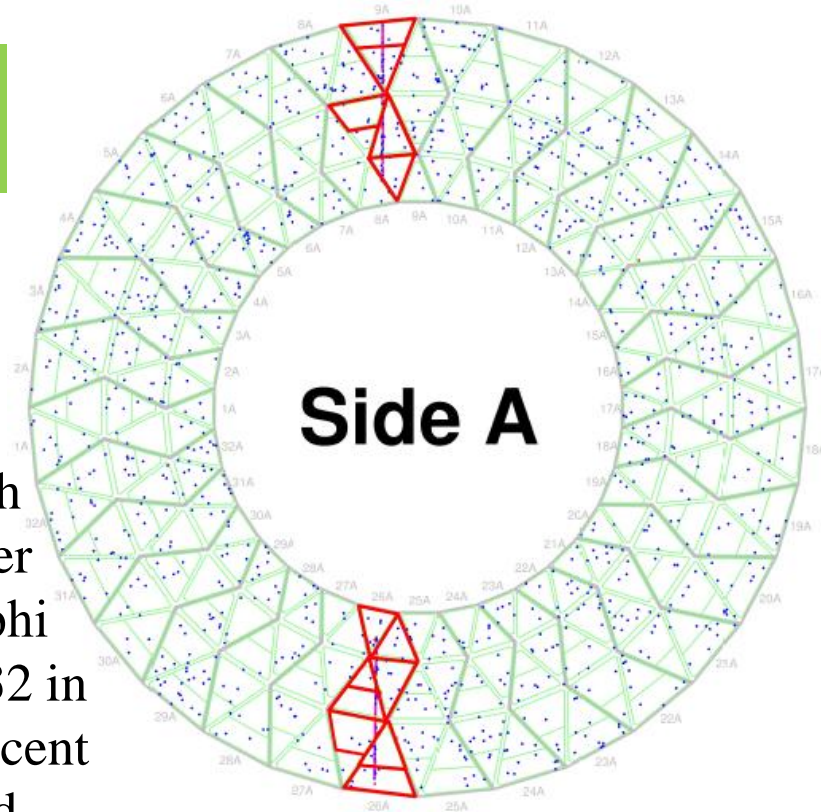

# TRT Performance - Efficiency

- The TRT efficiency is defined as the number of straw with a hit on the track divided by the number of straws crossed by the track.
- The known non-functioning straws (2%) are excluded from this study
- **Same performance 900GeV/7TeV**
- Track selection cuts:
  - Pixel hit  $\geq 1$
  - SCT hits  $\geq 6$
  - TRT hits  $\geq 15$
  - $p_T > 0.5$  GeV
  - $|d_0| < 10$  mm
  - $|z_0| < 300$  mm

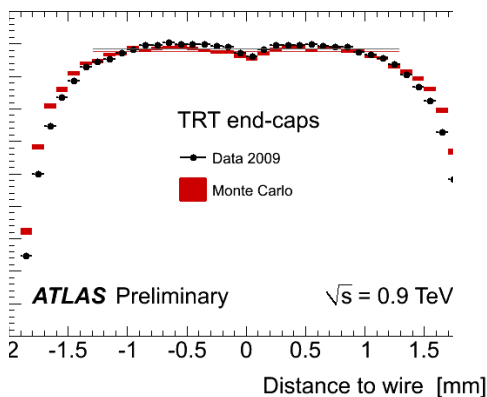
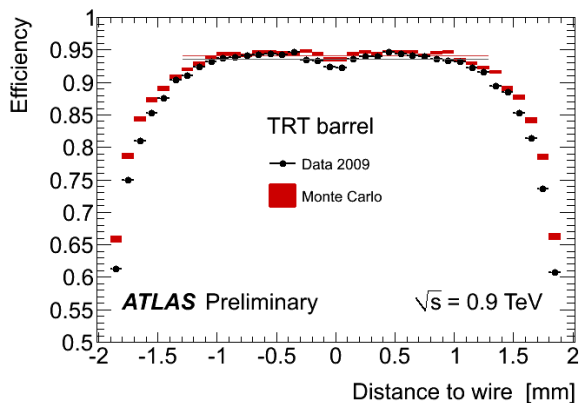
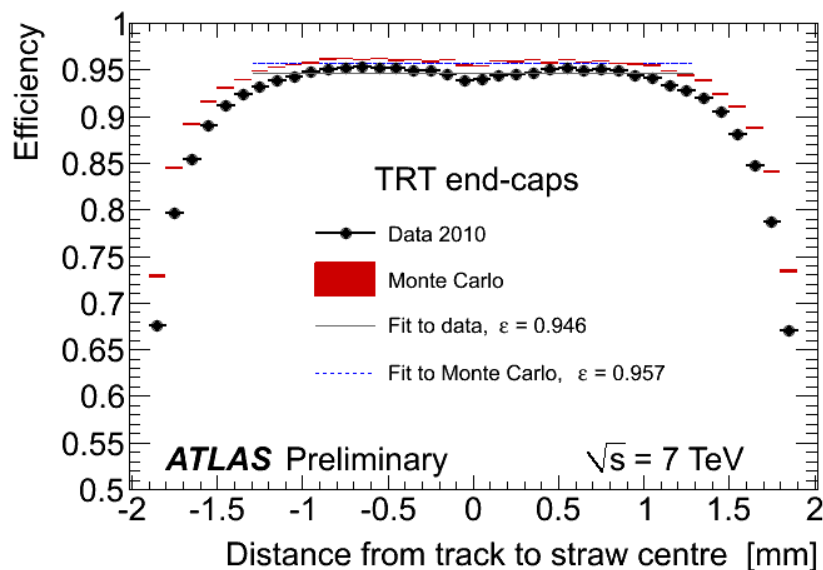
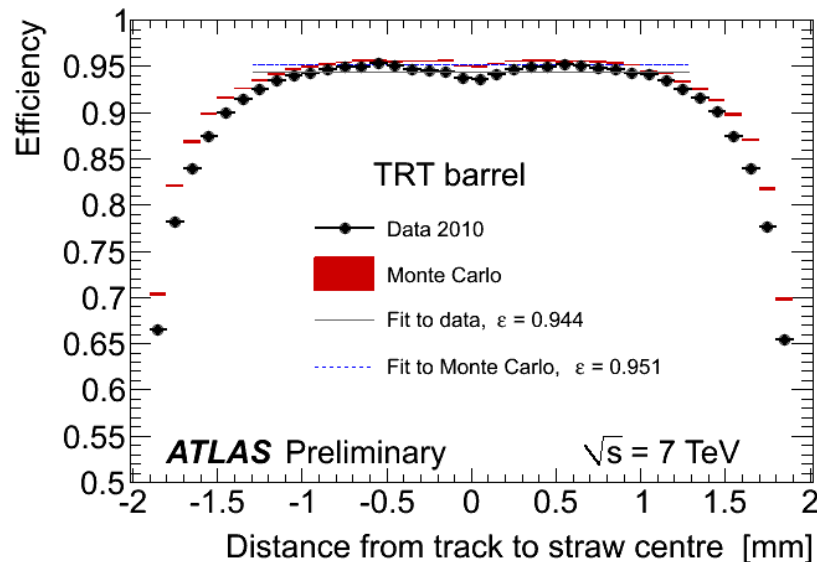

# TRT Performance - Particle Identification (0.9 TeV)

Transition Radiation:

- Photon(s) are emitted by a charged particle traversing the boundary between material with different dielectrical constants  $\epsilon_1, \epsilon_2$
- Intensity  $I \sim \gamma = E/m$ ,  $\theta \sim 1/\gamma$
- Emitted photons per transition  $\sim O(\alpha_{EM}\gamma)$ 
  - Many transitions needed
- Emitted energy  $\sim (\epsilon_1 - \epsilon_2)$ 
  - gas and light plastic, photon energies 5 – 30 keV
- To detect TR photons, a gas with a high photon absorption cross section is required - use a Xe-based mixture

The TRT is able to separate electrons from pions over a momentum range between 1 GeV/c < |pT| < 150 GeV/c“

- requirement for the selection of electron candidates: HT probability on track > 12%

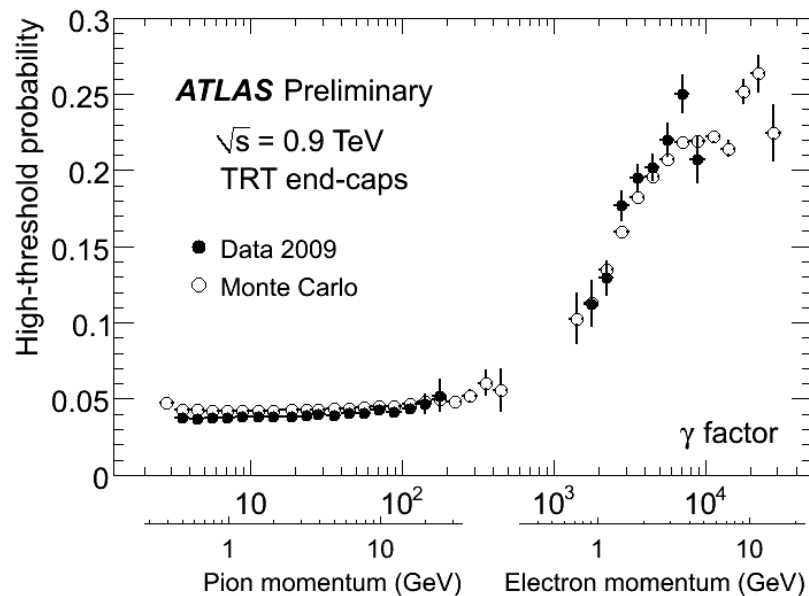
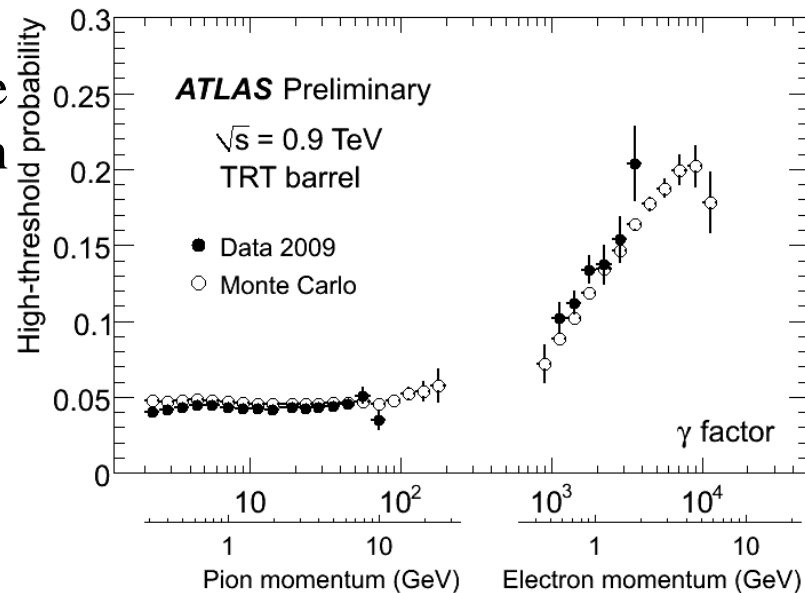

# TRT Performance - Particle Identification (7 TeV)

Transition Radiation:

- Photon(s) are emitted by a charged particle traversing the boundary between material with different dielectrical constants  $\epsilon_1, \epsilon_2$
- Intensity  $I \sim \gamma = E/m, \theta \sim 1/\gamma$
- Emitted photons per transition  $\sim O(\alpha_{EM}\gamma)$ 
  - Many transitions needed
- Emitted energy  $\sim(\epsilon_1 - \epsilon_2)$ 
  - gas and light plastic, photon energies 5 – 30 keV
- To detect TR photons, a gas with a high photon absorption cross section is required - use a Xe-based mixture

The TRT is able to separate electrons from pions over a momentum range between 1 GeV/c < |pT| < 150 GeV/c“

- requirement for the selection of electron candidates: HT probability on track > 12%

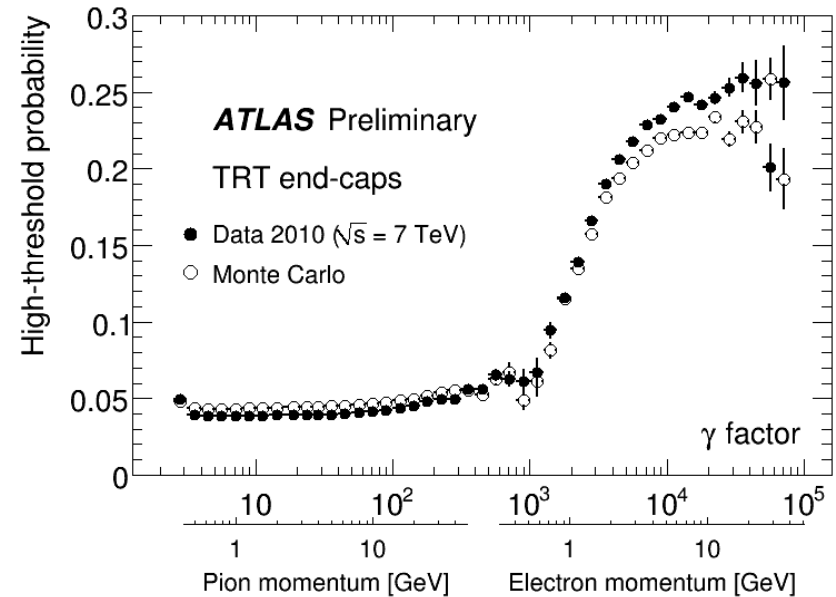
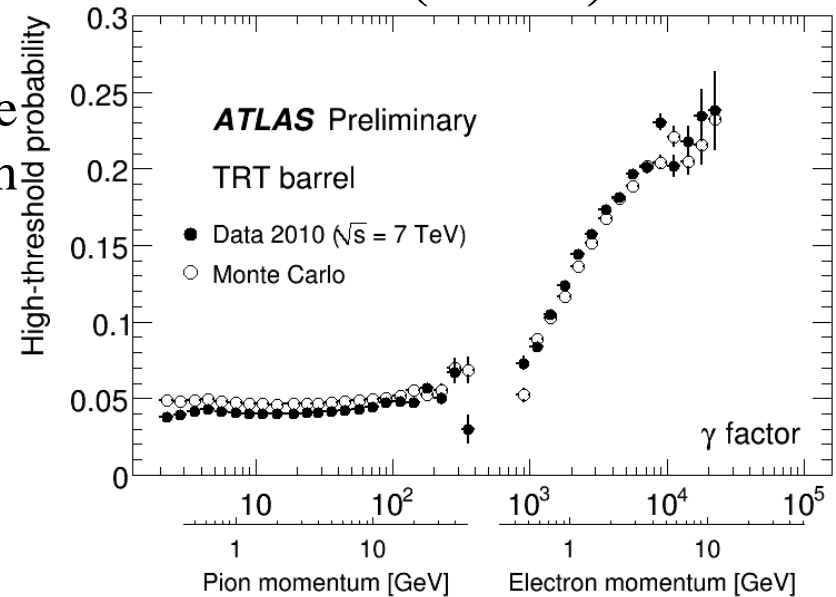

# TRT Performance - Particle Identification

○ Time over threshold (ToT) is a second method of Particle ID

□ The ToT is corrected for the particle path length in the straw

□ ToT is corrected for z effects on the straws and divided by transverse length in the straws

□ Pion candidates:

❖ *SCT hits > 3*

❖ *TRT hits > 20*

❖ *Tracks from conversions are rejected*

□ Electron candidates:

❖ *Pair Conversions*

□ Selection performance in MC:

❖ Pion selection:

• *80.5% pions*

• *11.3% kaons*

• *6.9% are protons*

• *1.3% are other particles*

❖ Electron selection:

• *99.6% electrons*

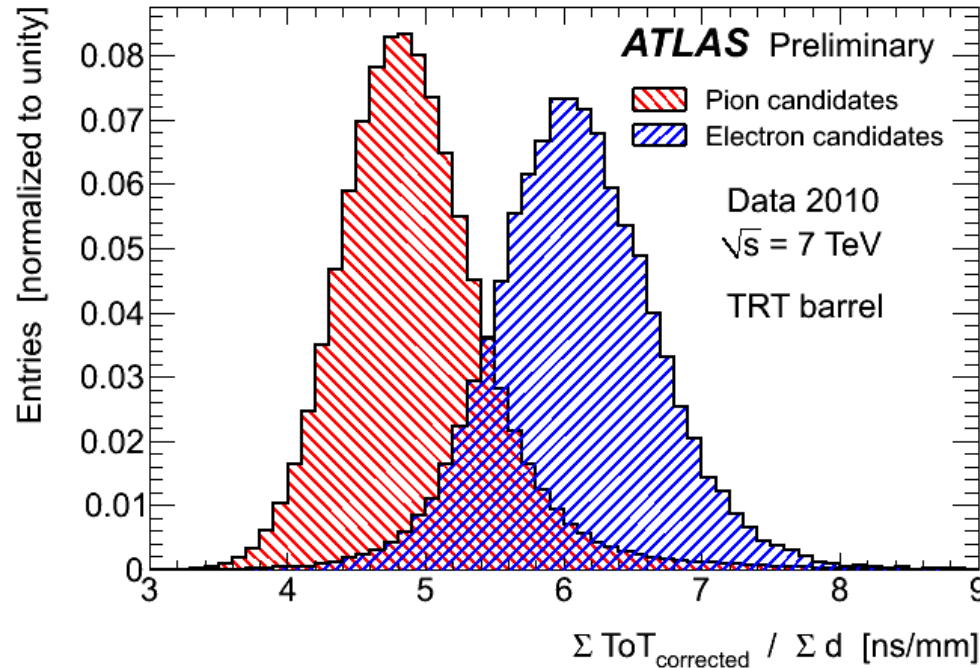



# Summary

- Very successful construction and commissioning process has been accomplished in the last years
- Good understanding of the detector achieved with Cosmic Rays and Collisions
- TRT is operating smoothly on a 24/7 basis since September 2009
- Many studies ongoing to improve TRT performance
- Many analyses of first collisions data already make use of the excellent TRT performance
- The detector has started collecting data for at least next 10 years