

# HP2.3rd - GGI Florence

*High Precision for Hard Processes at the LHC*

---

Top Quark Physics  
with  
D-Dimensional Generalized Unitarity

Markus Schulze

in collaboration with K. Melnikov



# Top quark phenomenology

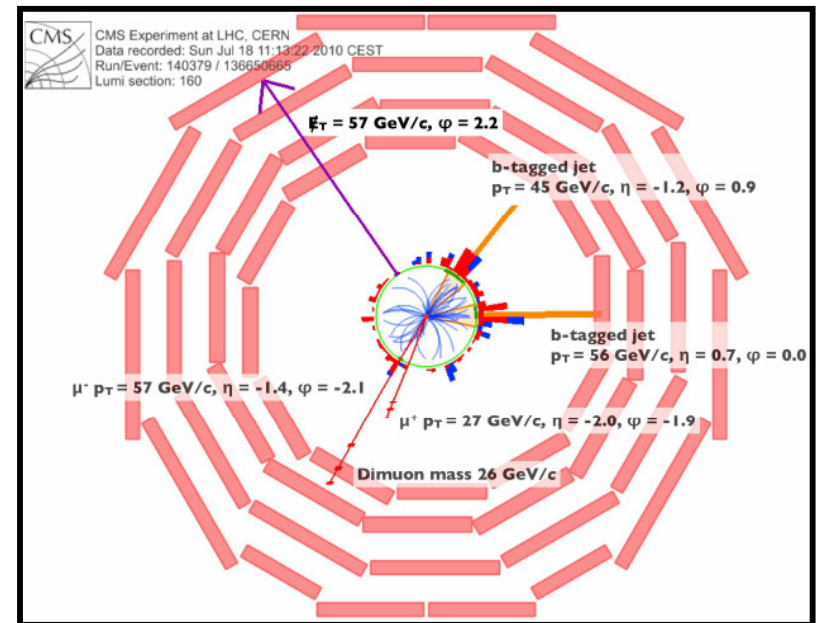
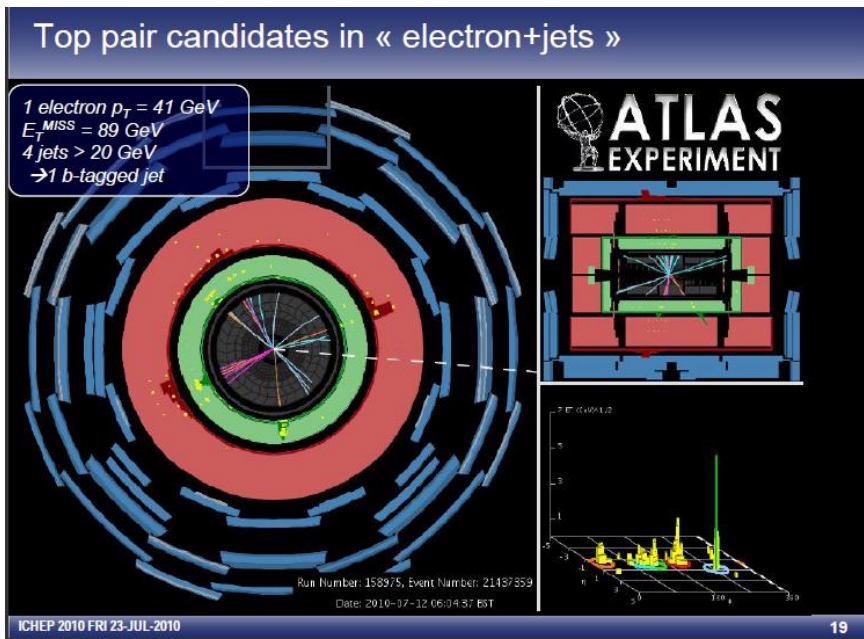

LHC (7 TeV):  $\sigma_{t\bar{t}} \approx 200$  pb

Tevatron:  $\sigma_{t\bar{t}} \approx 7$  pb

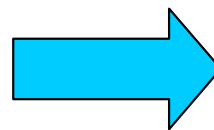

$\approx 200$  k events from  
 LHC (7 TeV) with  $1 \text{ fb}^{-1}$

vs.

$\approx 30$  k events from  
 Tevatron with  $5 \text{ fb}^{-1}$

# Outline

NLO QCD corrections to  $t\bar{t}$  production and decay

Calculation framework

Top quark spin correlations

Top quark mass measurements at NLO QCD + [S. Biswas]

[ JHEP 0908:049, 2009 ],

[ JHEP 1008:048, 2010 ]

# Is this really new?

No and Yes.

Literature on hadronic top production beyond leading-order is rich:

- **stable top quarks:**

- Classic NLO QCD corrections:**

- Beenakker, Dawson, Ellis, Frixione, Meng, Nason, v. Neerven, Schuler, Smith; Czakon, Mitov

- Threshold resummation & Coulomb corrections:**

- Banfi, Bonciani, Catani, Czakon, Frixione, Kidonakis, Kiyo, Kühn, Laenen, Mangano, Mitov, Moch, Nason, Ridolfi, Steinhauser, Sterman, Uwer, Vogt

- Electroweak corrections:**

- Beenakker, Bernreuther, Fuecker, Denner, Hollik, Kao, Kollar, Kühn, Ladinsky, Mertig, Moretti, Nolten, Ross, Sack, Scharf, Si, Uwer, Wackerroth, Yuan

- NNLO QCD contributions:**

- Anastasiou, Aybat, Bonciani, Czakon, Ferroglia, Gehrmann, Körner, Langenfeld, Maitre, Merebashvili, Mitov, Moch, Rogal, Studerus, Uwer

- **decays of top quarks:**

- Study of non-factorizable corrections:**

- Beenakker, Berends, Chapovsky, Fadin, Khoze, Martin, Melnikov, Yakovlev

- Factorizable correction to top decays:**

- Czarnecki, Jezabek, Kühn; Bernreuther, Brandenburg, Si, Uwer

- Spin correlations:**

- Mahlon, Parke; Bernreuther, Brandenburg, Si, Uwer

- **event generators:**

- MC@NLO:** Frixione, Webber; Laenen, Motylinski, Nason, White

- POWHEG:** Frixione, Nason, Oleari, Ridolfi

# Is this really new?

No and Yes.

Only very recently:

NLO QCD corrections to  
top quark pair production and decay at hadron colliders

Bernreuther, Si (2010); Melnikov, M.S. (2009)

Top quark decays: leptonic or hadronic decays at NLO  
Narrow Width Approximation  $\Gamma_t/m_t \rightarrow 0$   
neglect non-factorizable corrections

Allows for:

- realistic description of the final state
- implementation of arbitrary detector cuts
- accounting for all spin correlations

# Our implementation

leading order:

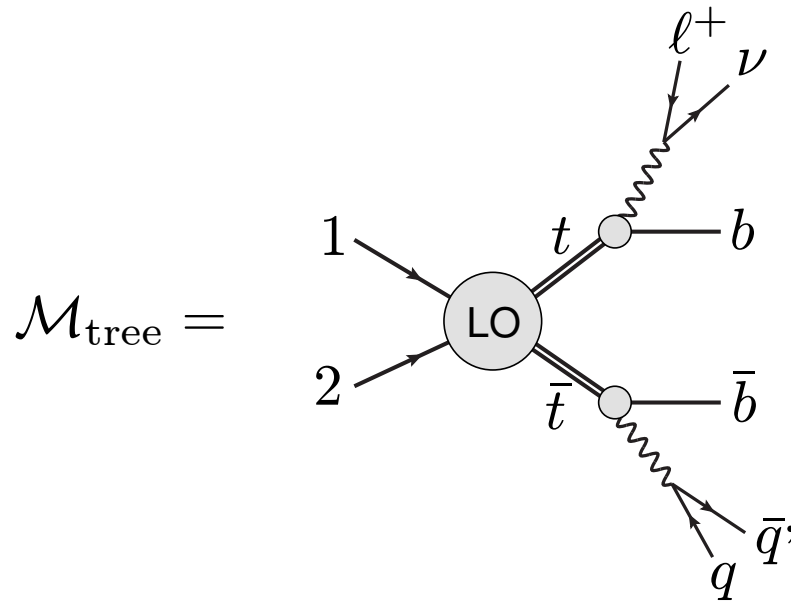

We calculate helicity amplitudes.

- Generate phase space of top quarks
- Generate phase space of decay particles
- $\bar{u}(p_t) \rightarrow \tilde{u}(p_t) = \mathcal{M}(t \rightarrow b\ell^+\nu) \frac{i(\not{p}_t + m_t)}{\sqrt{2m_t\Gamma_t}}$
- $\mathcal{M}_{\text{tree}} = \tilde{u}(p_t) \tilde{\mathcal{M}}(12 \rightarrow \bar{t}t) \tilde{v}(p_{\bar{t}}) + \mathcal{O}\left(\frac{\Gamma_t}{m_t}\right)$

# Our implementation

Next-to-leading order:

Production

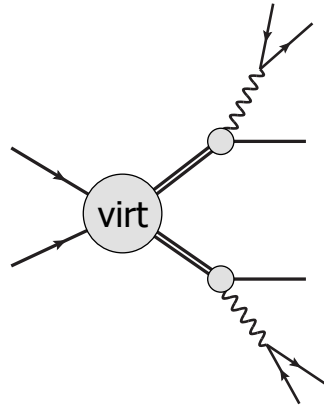

$D$ -dimensional generalized unitarity  
+ OPP

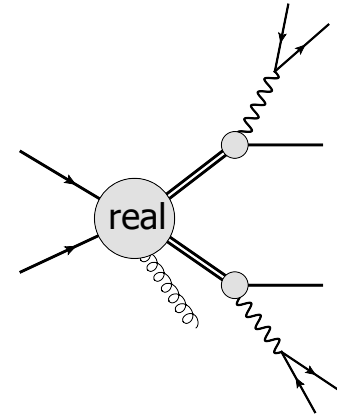

Dipole subtraction  
with alpha dependence

# Our implementation

Next-to-leading order:

Production

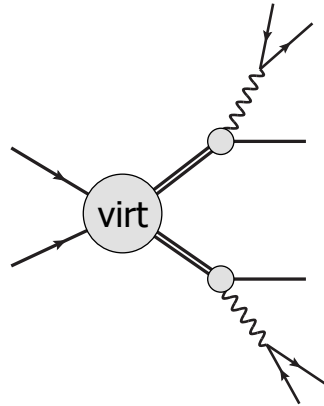

$D$ -dimensional generalized unitarity  
+ OPP

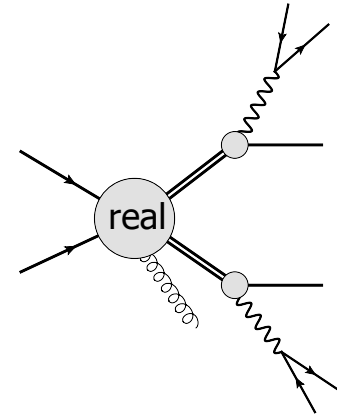

Dipole subtraction  
with alpha dependence

Decay

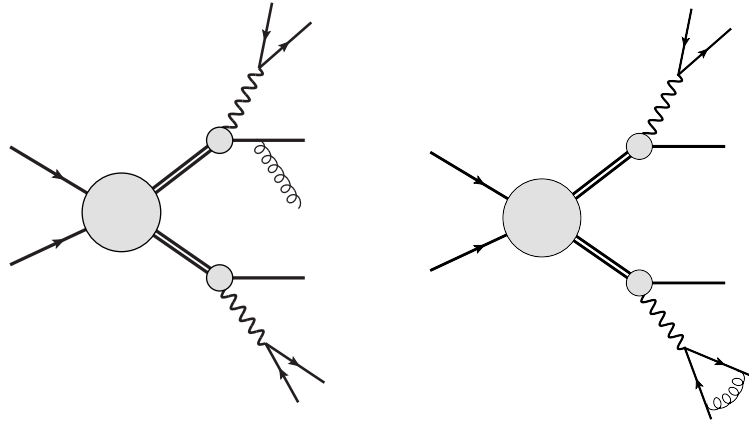

+ extra:

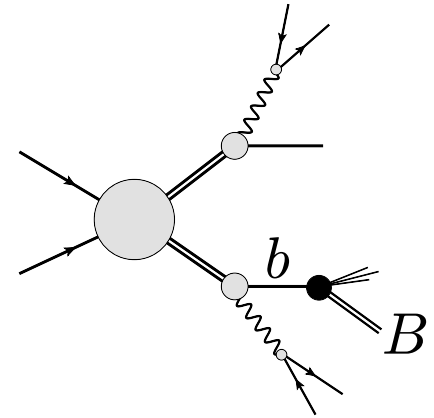

B-meson fragmentation



## How relevant is this?

- Measurement of the total  $t\bar{t}$  cross section

The total cross section is claimed to be measured with 5-10% accuracy

NLO QCD corrections: typically 10-30%

## How relevant is this?

- Measurement of the total  $t\bar{t}$  cross section

The total cross section is claimed to be measured with 5-10% accuracy

NLO QCD corrections: typically 10-30%

**Note:** The total cross section is never measured in an experiment

$$\sigma_{\text{tot}} = \frac{N_{\text{obs}}}{\mathcal{L}} \cdot \frac{1}{A} \quad \text{with} \quad A = \frac{\sigma_{\text{cuts}}}{\sigma_{\text{tot}}}$$

To claim that the total cross section has been measured with NLO accuracy, we need to calculate  $A$  at NLO QCD. Otherwise, we introduce potential biases.

- Top quark spin correlations

Spins of production and decay mechanism are interlocked

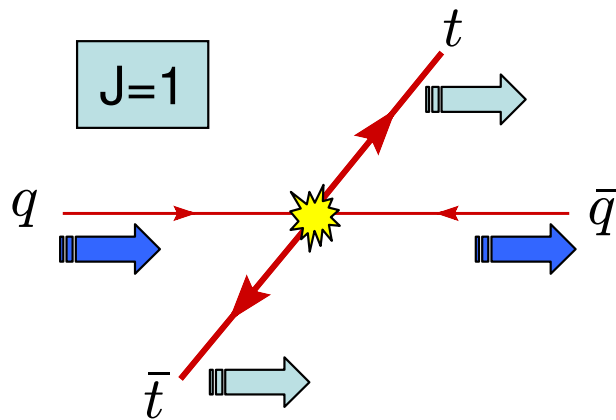

close to threshold:  
S-wave production  
( $L=0$ )

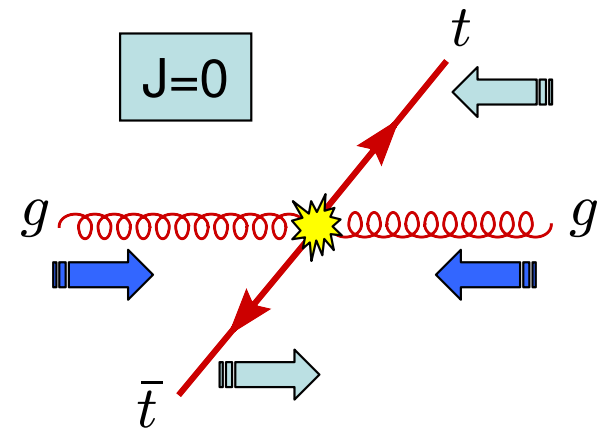

$\Rightarrow$  leptons preferably **anti-parallel**

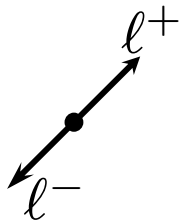

$\Rightarrow$  leptons preferably **parallel**

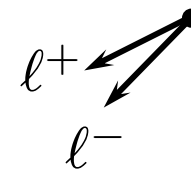

- Top quark spin correlations

These effects are only observable for top quarks

$$\frac{\text{spin-flip time}}{\text{life time}} \sim \frac{m_{\text{top}}}{\Lambda_{\text{QCD}}^2} \cdot \Gamma_{\text{top}}$$

- **Top quark spin correlations**

These effects are only observable for top quarks

$$\frac{\text{spin-flip time}}{\text{life time}} \sim \frac{m_{\text{top}}}{\Lambda_{\text{QCD}}^2} \cdot \Gamma_{\text{top}}$$

So far, only one measurement exists:

$$\frac{1}{\sigma} \frac{d^2\sigma}{d \cos \phi_i d \cos \phi_j} = \frac{1}{4} (1 - C \cos \phi_i \cos \phi_j)$$

requires boost into top rest frames  
and specification of a quantization axis

$$C(\text{SM theory}) = 0.78$$

[Bernreuther et..al.]

$$C(\text{Tevatron}) = 0.32_{-0.78}^{+0.55}$$

[CDF+D0, 4.3fb<sup>-1</sup>]

Mahlon, Parke: measure lepton opening angle  
with  $m_{t\bar{t}} < 400$  GeV

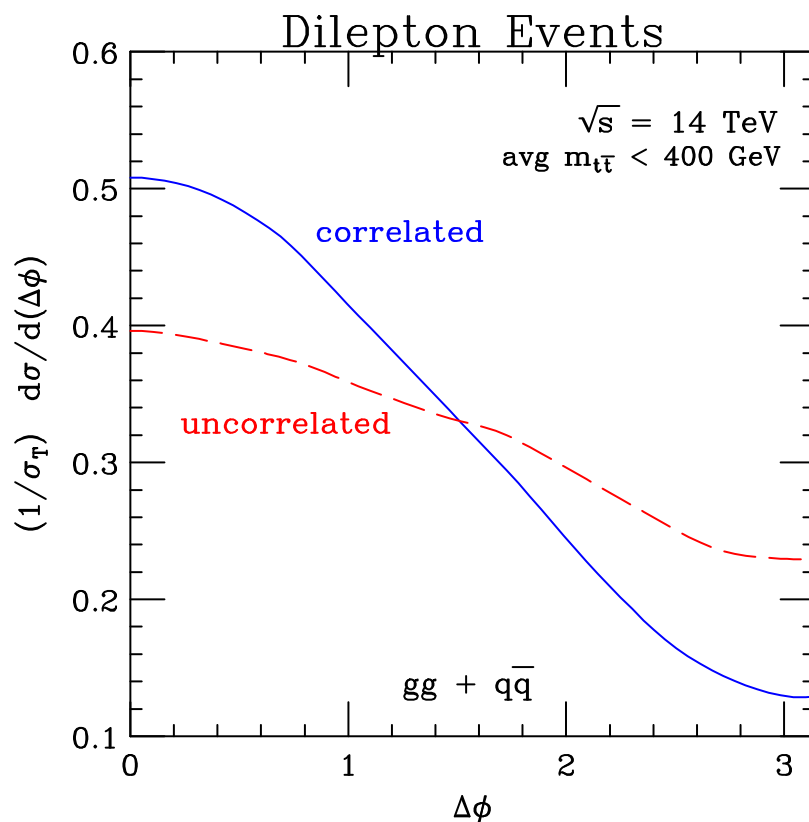

$m_{t\bar{t}}$  is not an observable

Cut can be applied to the average,  $\langle m_{t\bar{t}} \rangle$

our suggestion: measure lepton opening angle  
with special cuts on leptons

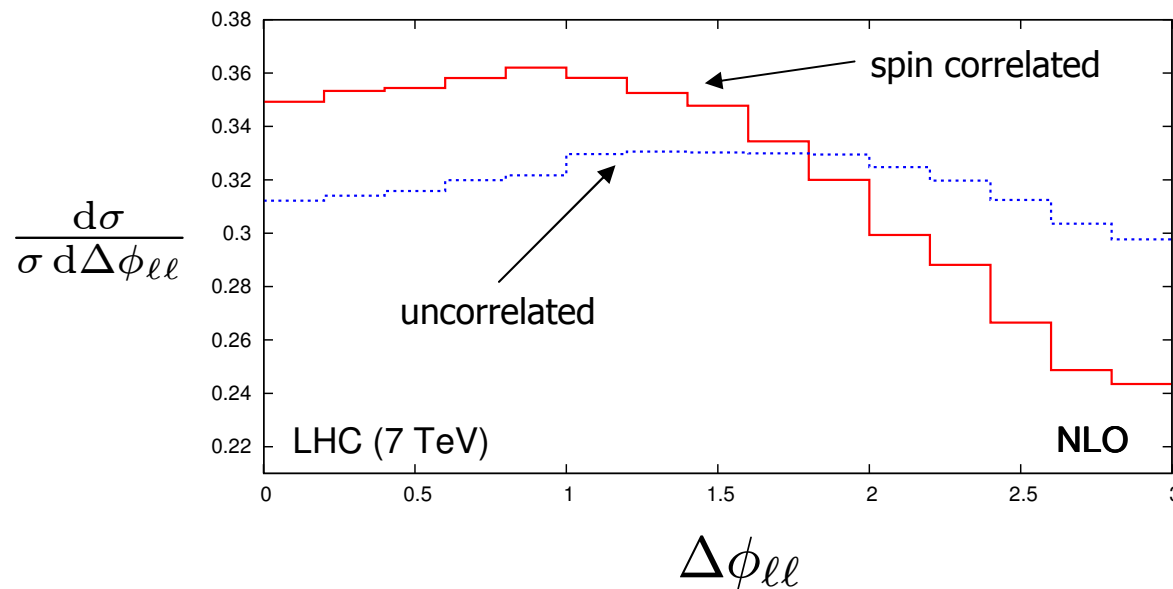

Cuts:

$$p_{T,\ell} > 20\text{GeV}$$

$$p_{T,\text{bjet}} > 25\text{GeV}$$

$$p_{T,\text{miss}} > 40\text{GeV}$$

$$\eta_{\ell}, \eta_{\text{bjet}} < 2.5$$

$$+ m_{\ell\ell} < 100\text{GeV}$$

$$p_{T,\ell} < 50\text{GeV}$$

advantage: clean observable,  
simpler measurement

New ideas (under development):

define indicator  $r$  that is sensitive to spin correlations

$$r(\Phi) = \frac{|\mathcal{M}_{\text{corr}}|^2}{|\mathcal{M}_{\text{corr}}|^2 + |\mathcal{M}_{\text{unco}}|^2}$$

$\Phi$  depends on neutrino momenta which are unobservable

integration of  $r(\Phi)$  over neutrino momenta yields up to 8 solutions

$$r_{\text{obs}} = \sum_i r(\Phi_i)$$



we calculate  $r_{\text{obs}}$ , weighted with the cross section for spin correlated and uncorrelated top quarks



preliminary LO result

LHC(10TeV) di-leptonic final state  
with standard acceptance cuts

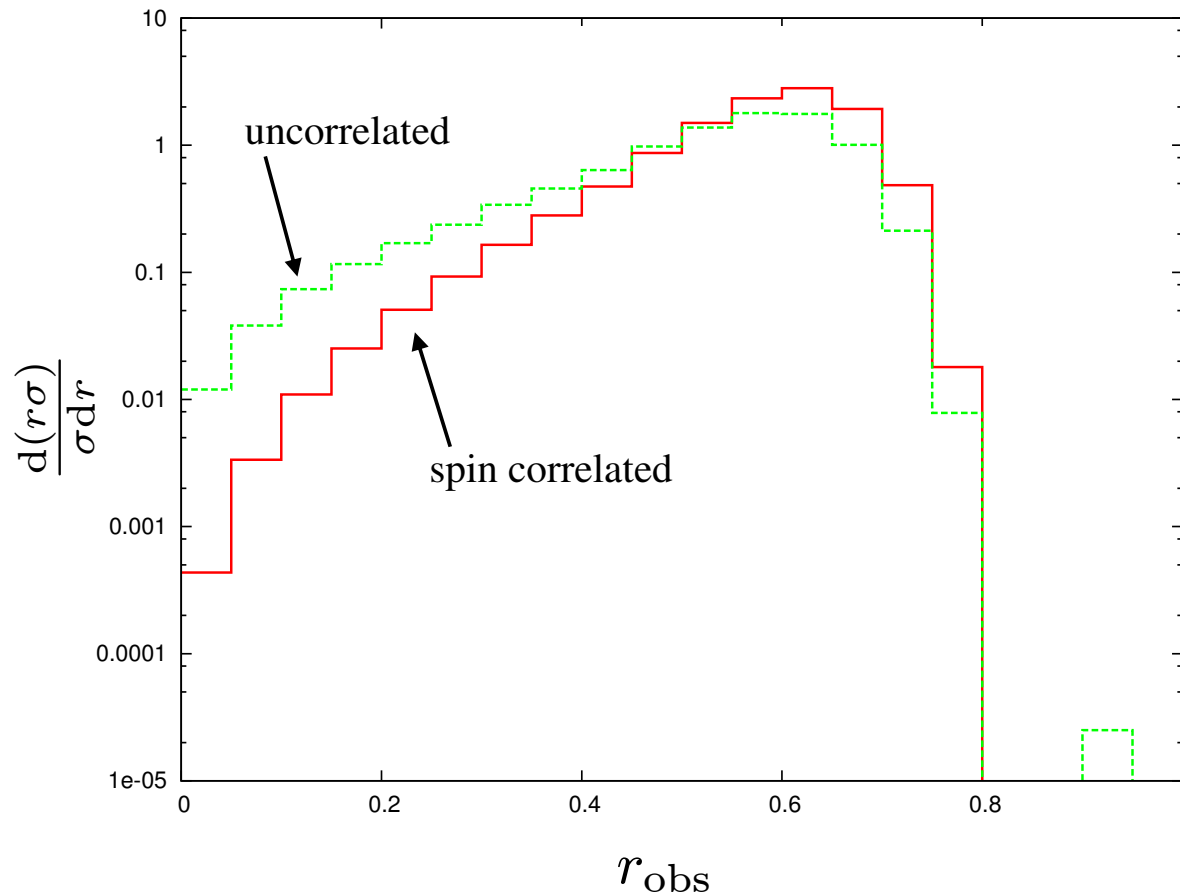

we find similar results for the Tevatron

- Top quark mass measurement at the LHC

Target precision is about 1 GeV, dominated by systematics.

Clean measurements involve kinematics of top quark decay products.

So far, systematics of all those studies were estimated by parton showers whose reliability at this level of precision is questionable.

one example:

average invariant mass of B-meson and lepton

J/Psi decay mode allows for very precise measurements already with 20 fb<sup>-1</sup>

→ calculate  $\langle m_{B\ell} \rangle$  as a function of  $m_{\text{top}}$

parton shower studies neglect  $t\bar{t}$  production process

$$\langle m_{Bl} \rangle_{\text{Herwig}} = 0.61m_{\text{top}} - 25.31\text{GeV}$$

$$\langle m_{Bl} \rangle_{\text{Pythia}} = 0.59m_{\text{top}} - 24.11\text{GeV}$$

$$\langle m_{Bl} \rangle_{\text{NLO}} = 0.60m_{\text{top}} - 26.7\text{GeV}$$

deviations in slope lead  
to  $\approx 3\text{GeV}$  uncertainty

uncertainties from scale  
variations comparable to  
expected experimental errors

parton shower studies neglect  $t\bar{t}$  production process

$$\langle m_{Bl} \rangle_{\text{Herwig}} = 0.61m_{\text{top}} - 25.31\text{GeV}$$

$$\langle m_{Bl} \rangle_{\text{Pythia}} = 0.59m_{\text{top}} - 24.11\text{GeV}$$

$$\langle m_{Bl} \rangle_{\text{NLO}} = 0.60m_{\text{top}} - 26.7\text{GeV}$$

deviations in slope lead to  $\approx 3\text{GeV}$  uncertainty

uncertainties from scale variations comparable to expected experimental errors

complete NLO study of  $pp \rightarrow t\bar{t} \rightarrow b\bar{b}l\nu jj$

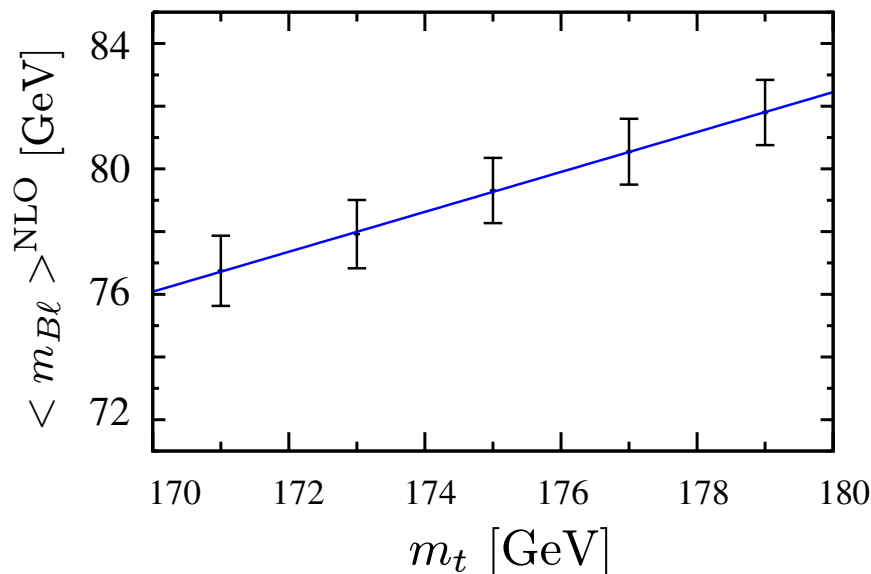

$$\langle m_{Bl} \rangle_{\text{NLO}}^{\text{prod}} = 0.64m_{\text{top}} - 32.12\text{GeV}$$

$\Rightarrow$  uncertainty of 1.5 GeV on  $m_{\text{top}}$

# Summary

- NLO QCD corrections to  $t\bar{t}$  production and decay
  - important contributions have been neglected in the past
  - realistic description of the final state incl. spin correlations is crucial for a precise understanding
  - allows for new improved studies of  
e.g. top mass measurement or spin correlations
- I left out:  
NLO QCD corrections to  $t\bar{t} + \text{jet}$  production