

HMPID offline status report

ALICE Offline Week, CERN, 5 July 2010

D. Di Bari, L. Molnar, G. Volpe

PLANNING STATUS

Quality assurance

- Implementation of run type in QA 60%
- Extract QA data for large Monte Carlo production 40%

Simulation

- Storing of the time information in the hits 100%
- Handling of the time information from hits during digitization 100%
- Accounting for detector response in the time information stored in digits 100%
- Correct treatment of the detector signal in the sdigits for event merging 100%

Documentation

- Doc 30 %

ALIGNMENT STATUS

- Using ~14 millions of events without magnetic field, HMPID alignment object have been created and stored in the Alien OCDB;
- LHC10b period data have been reconstructed (pass2) applying the new alignment.

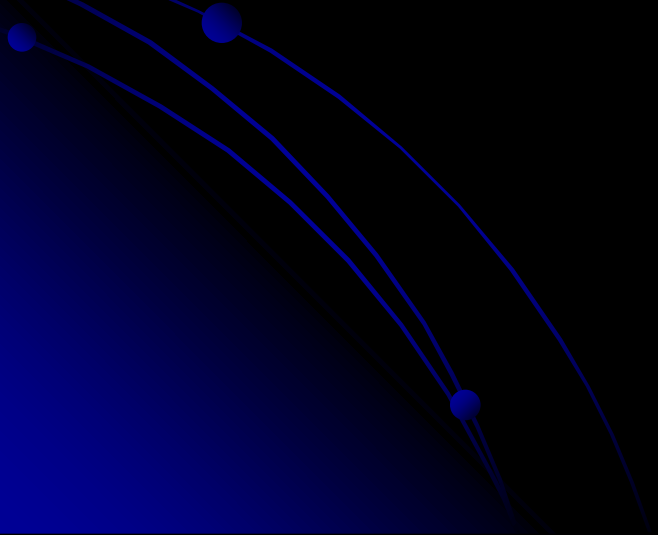

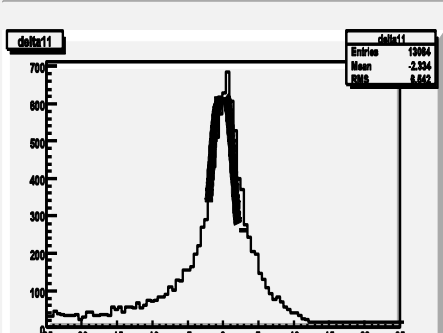
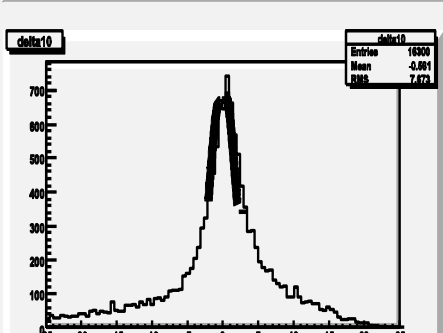
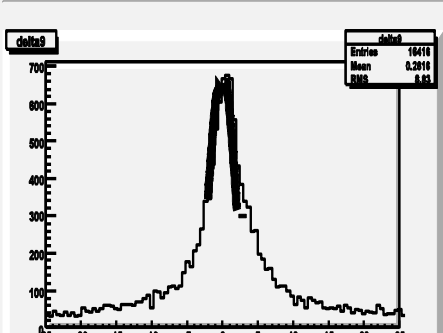
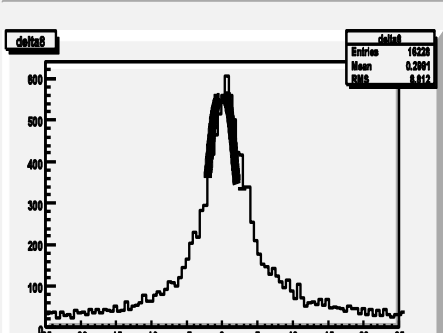
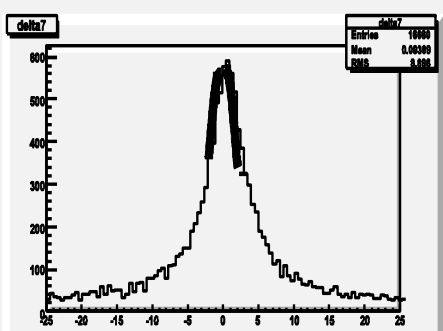
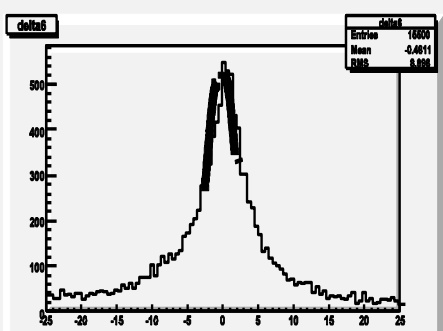
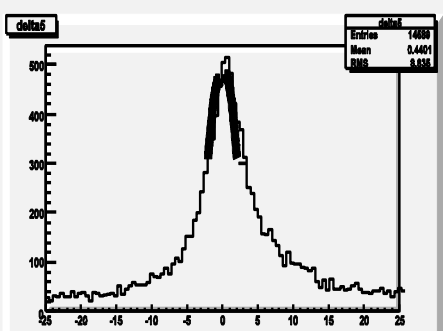
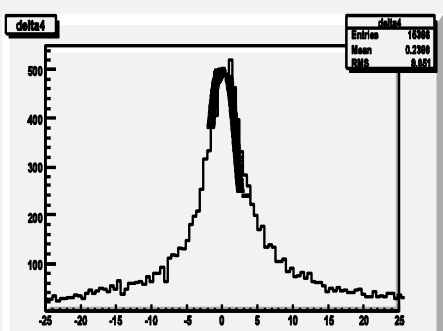
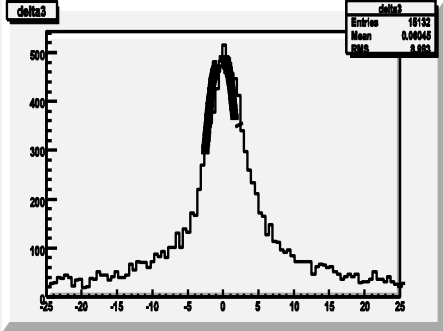
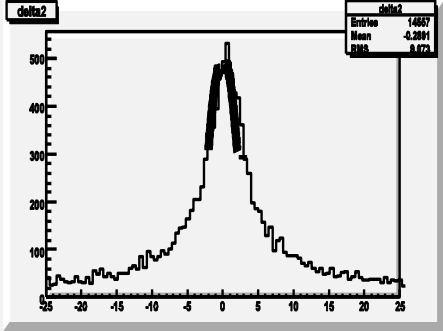
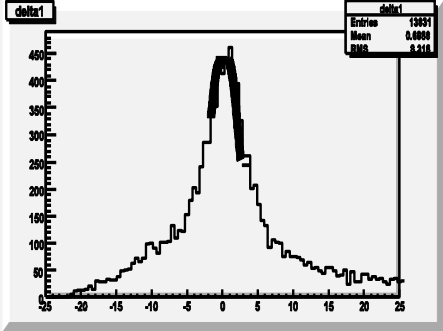
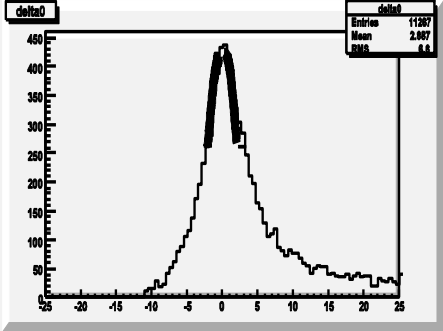

Zero magnetic field

shift 0.130 ± 0.040
 dist shift 0.534 ± 0.221
 dist from IP 494.458

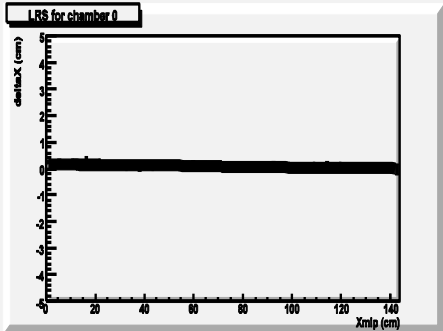

X residuals,
 chamber 0

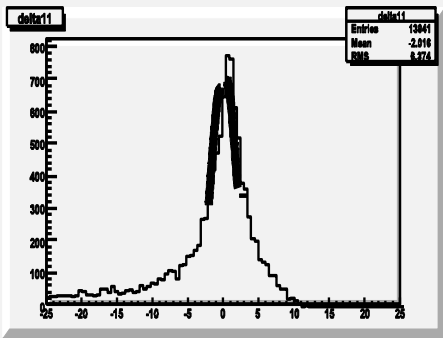
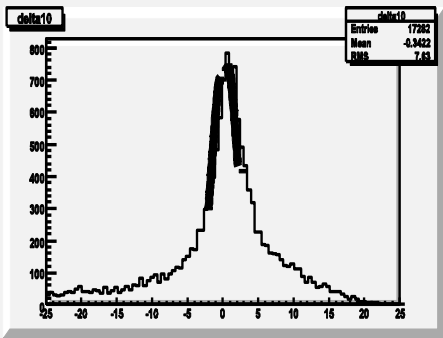
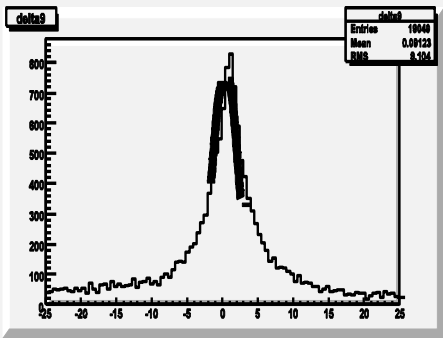
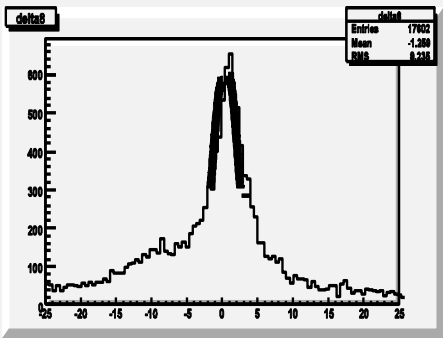
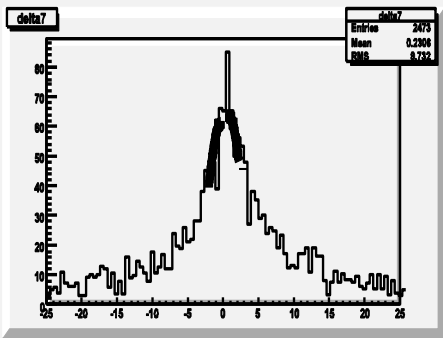
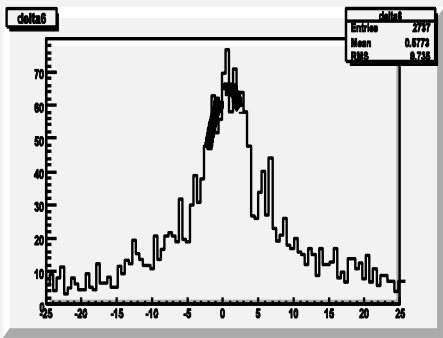
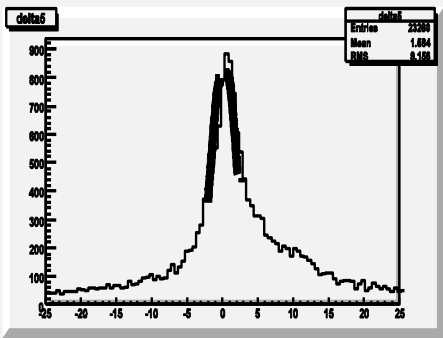
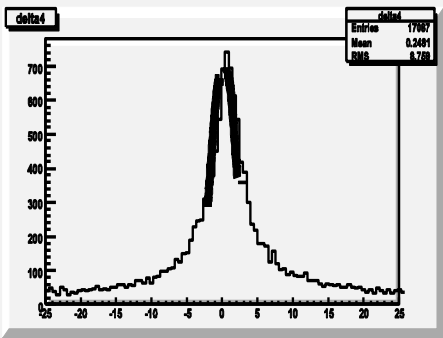
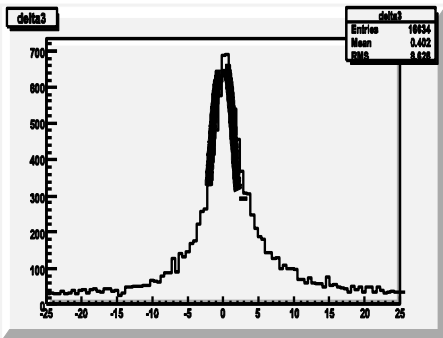
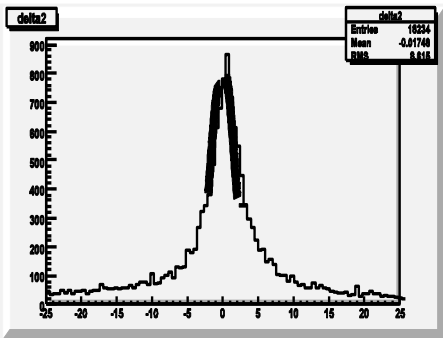
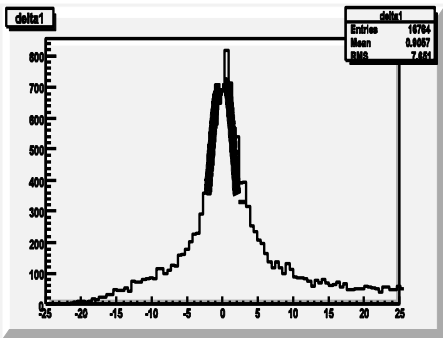
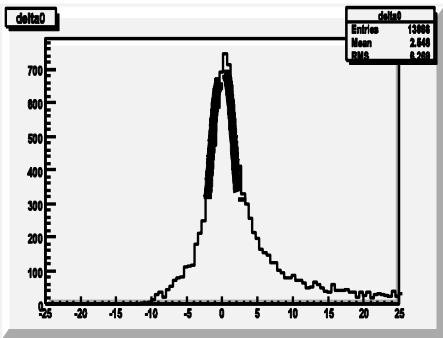

Zero magnetic field

shift 0.355 ± 0.022
 dist shift -1.541 ± 0.152
 dist from IP 494.458

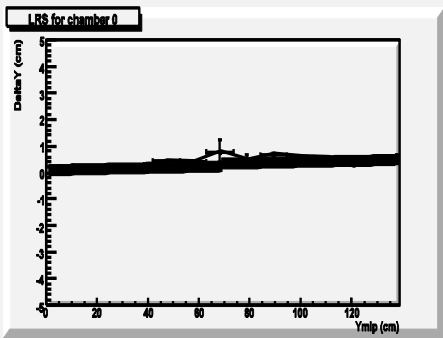

Y residuals,
 chamber 0

LRS for chamber 3

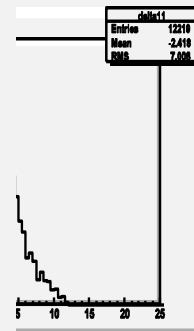
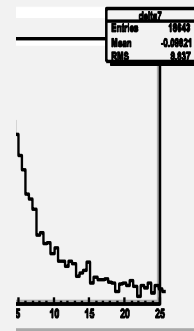
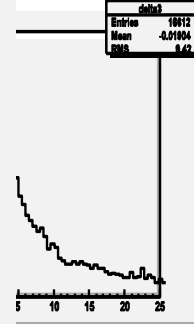
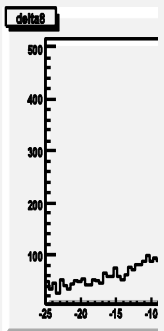
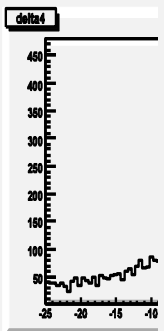
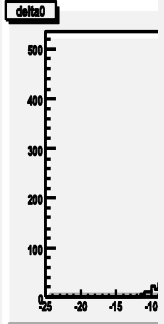
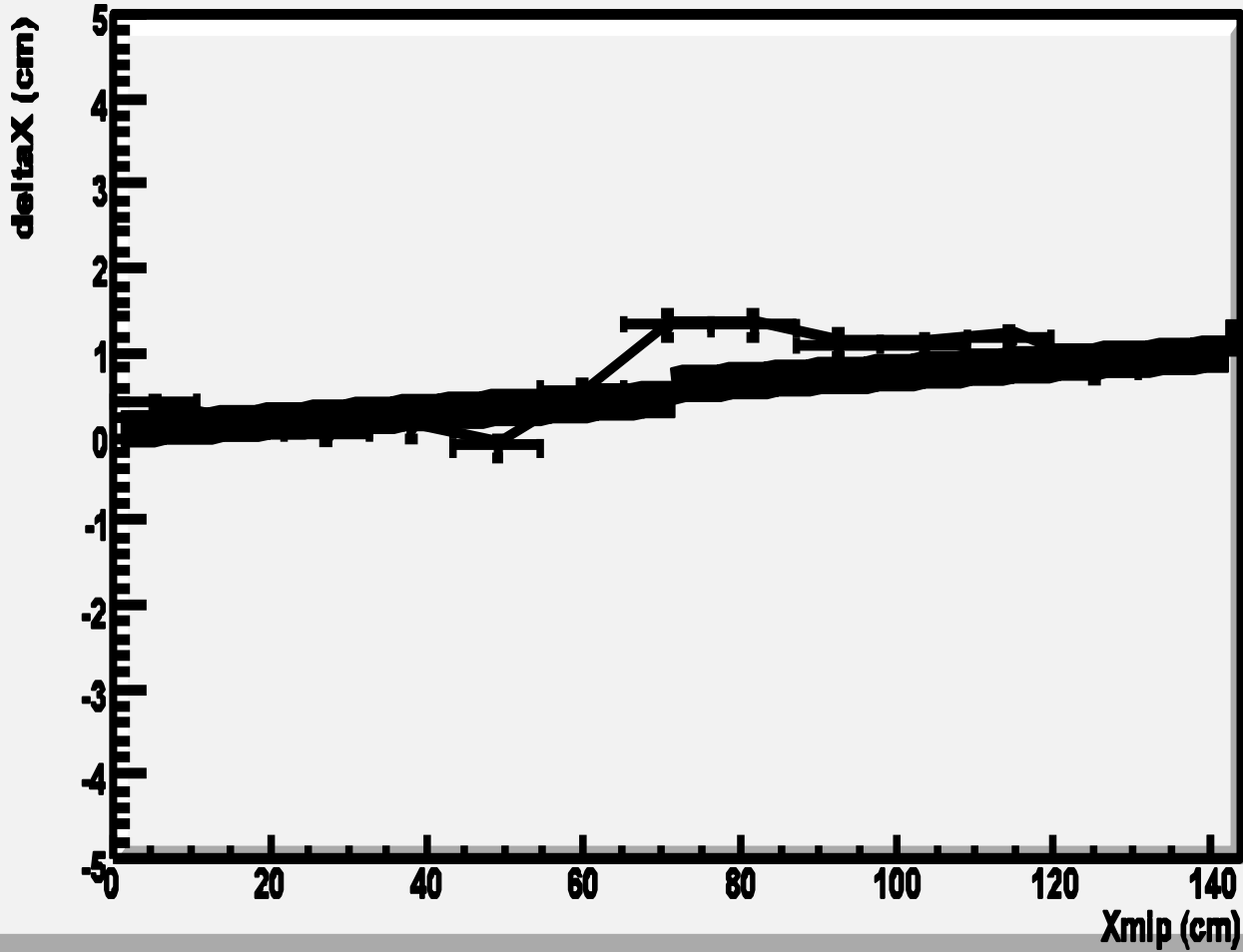

Zero magnetic field

shift 0.643 +/- 0.047
 dist shift -3.813 +/- 0.294
 dist from IP 496.485

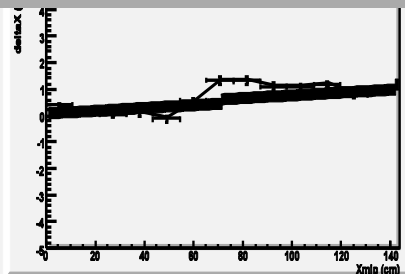

X residuals, chamber 3

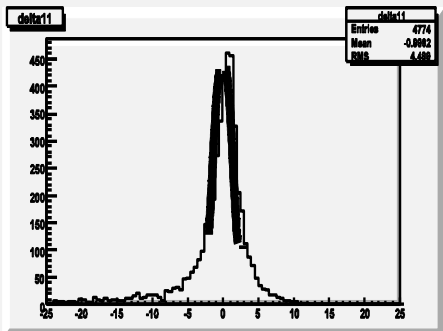
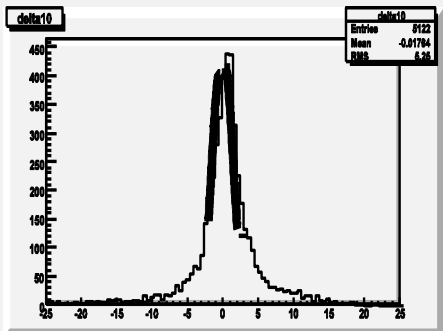
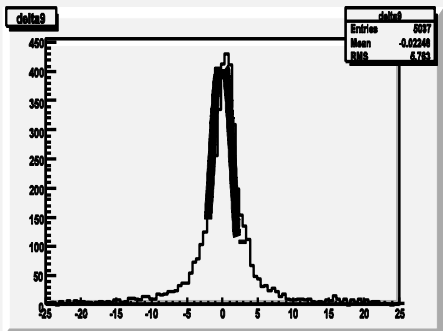
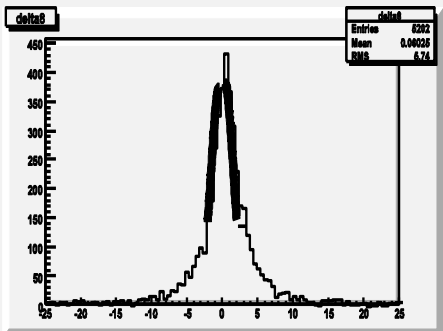
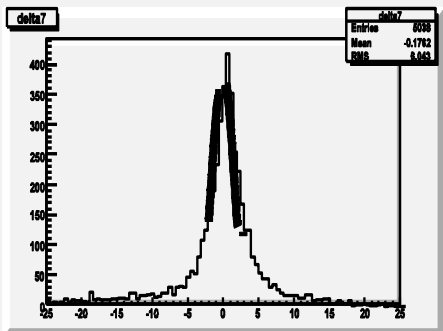
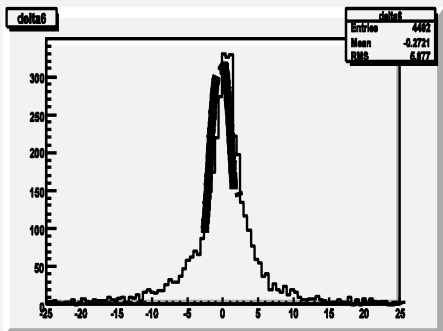
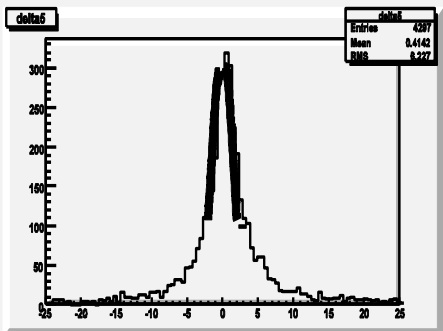
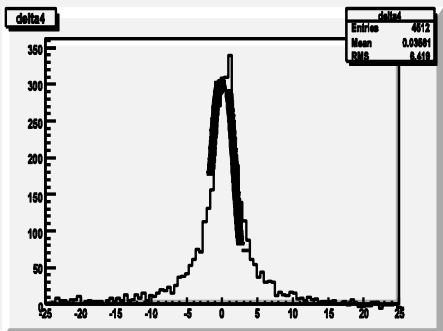
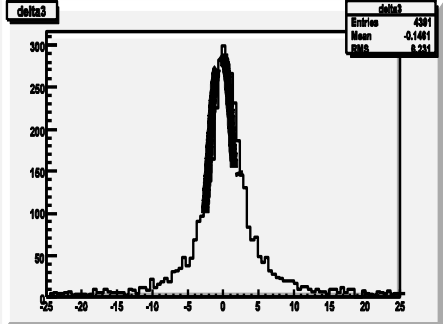
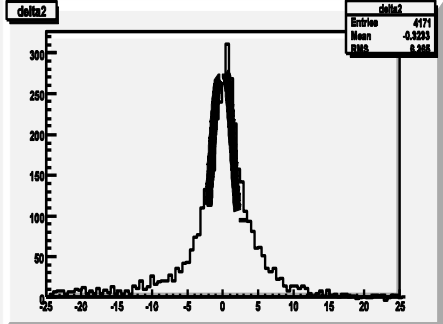
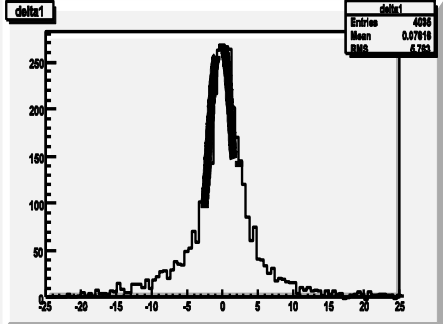
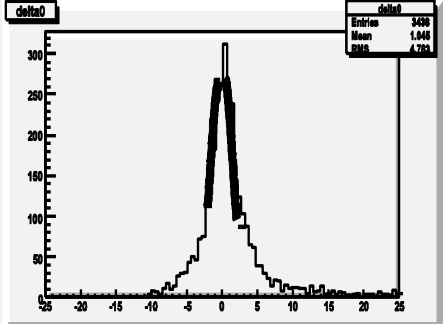

Magnetic field data

shift 0.112 ± 0.029
 dist shift -0.205 ± 0.168
 dist from IP 493.989

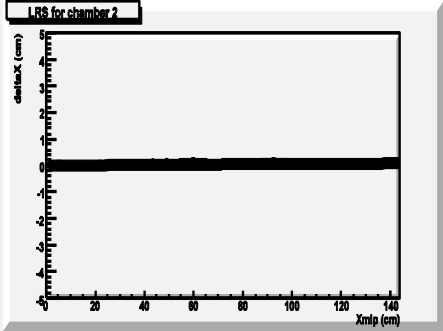

X residuals, chamber 2

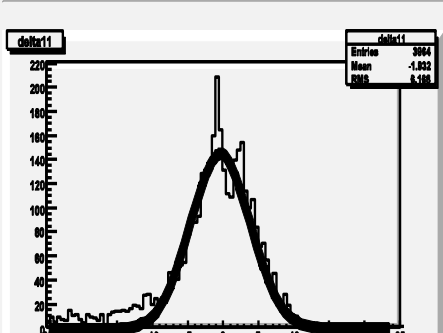
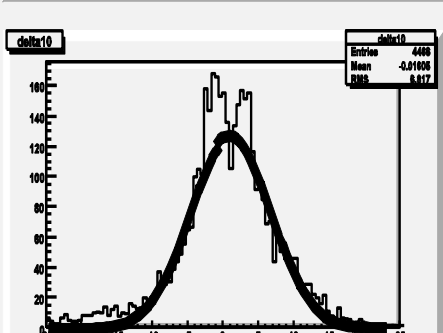
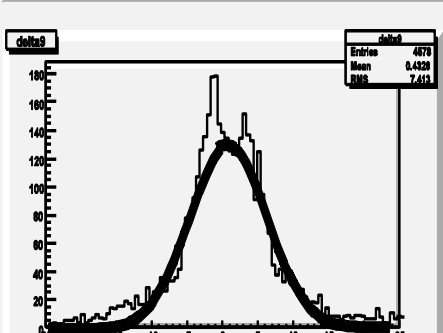
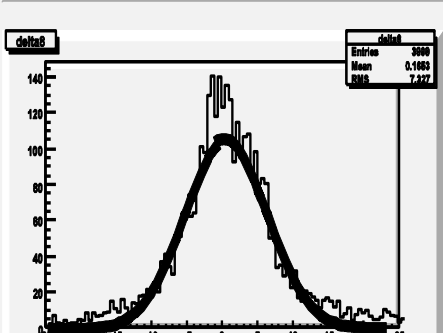
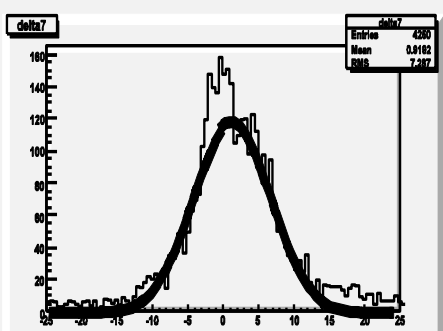
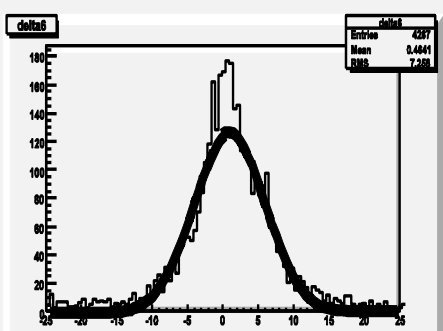
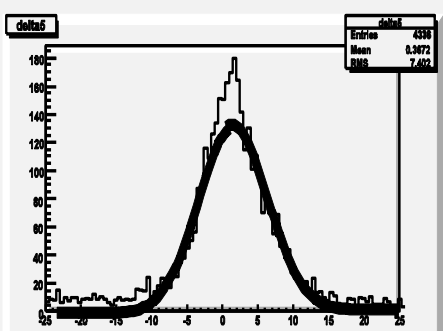
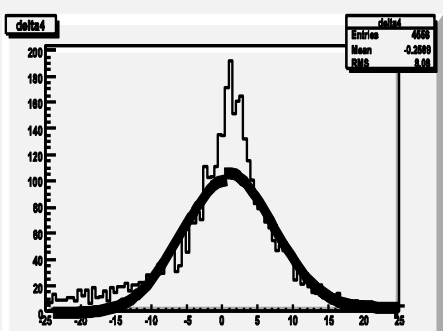
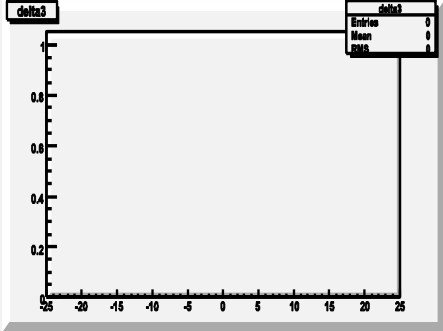
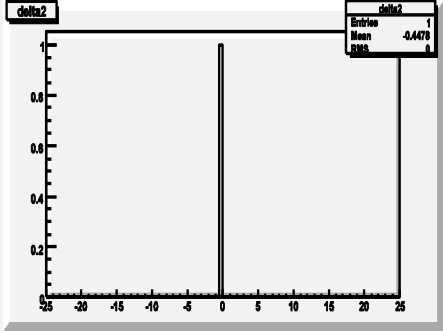
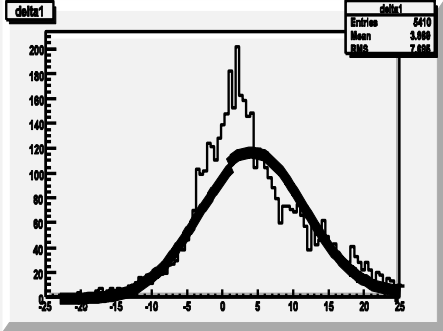
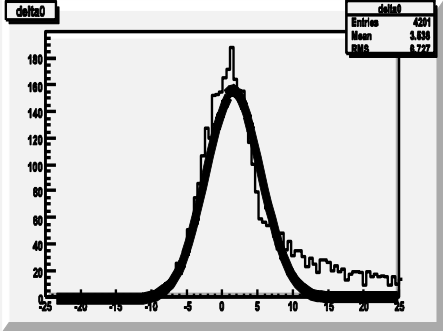

Magnetic field data

shift 0.901 ± 0.067
 dist shift 9.200 ± 0.423
 dist from IP 492.278

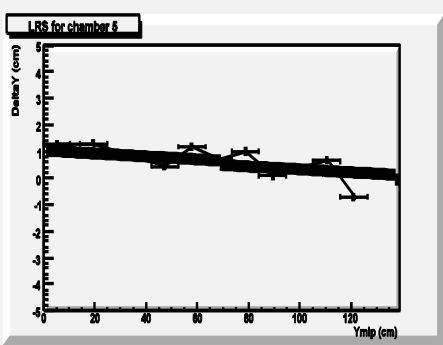

Y residuals, chamber 5

ALIGNMENT STATUS

- In the zero field data is present a discontinuity in the X residuals in the center of the chambers 1,3 and 5;
- The critical region corresponds to the central part of the TPC, where the membrane is placed, **no HMPID related problem**;
- The chamber 1, 3 and 5 have problems in the Y coordinate (sensible to the magnetic field), due to a depletion of reconstructed tracks in the TPC central region, **no HMPID related problem**.
- The current alignment status is satisfactory, nevertheless fine tuning is in progress

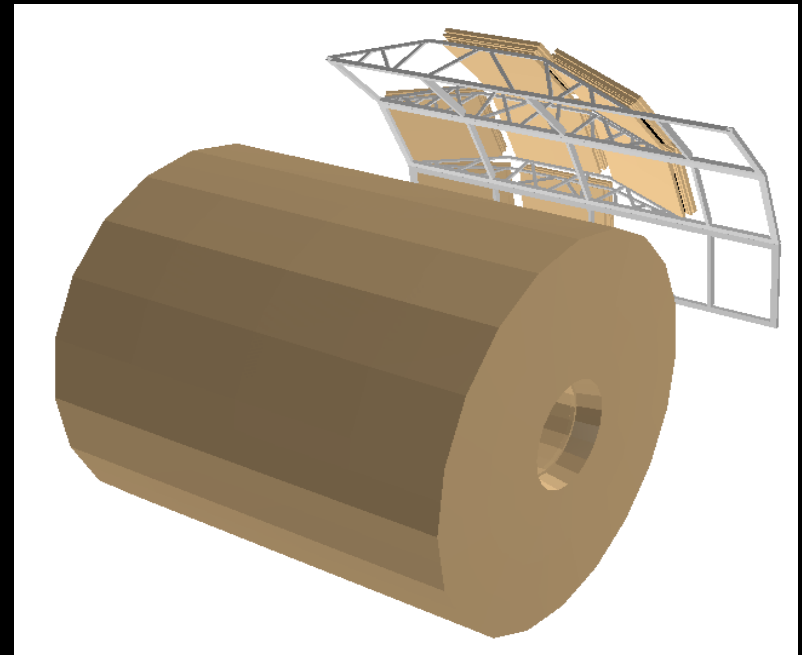
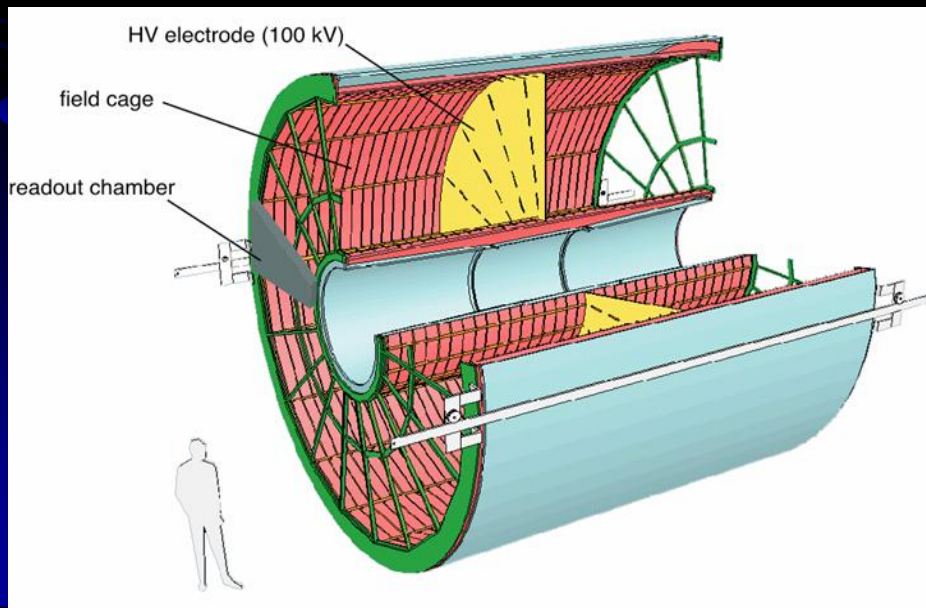

CALIBRATION STATUS

HMPID calibration
and condition
parameters

Chamber gain (HV, P)

Freon (C_6F_{14})
refractive index

CsI quantum
efficiency

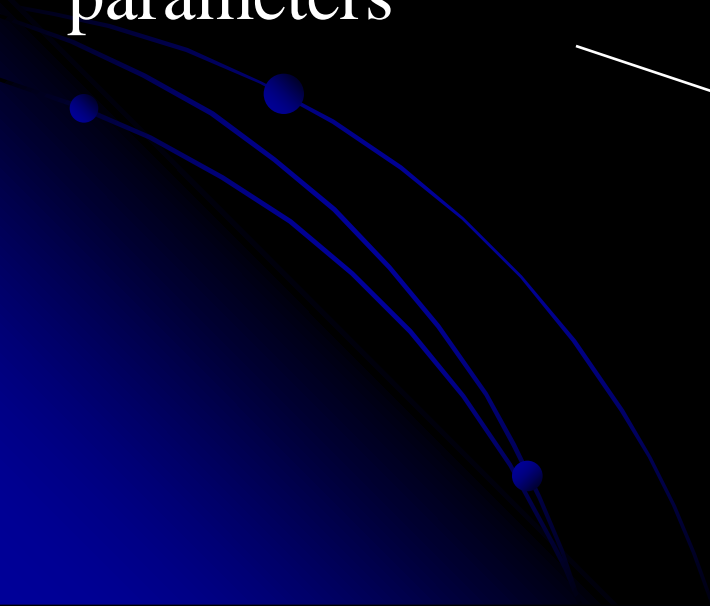
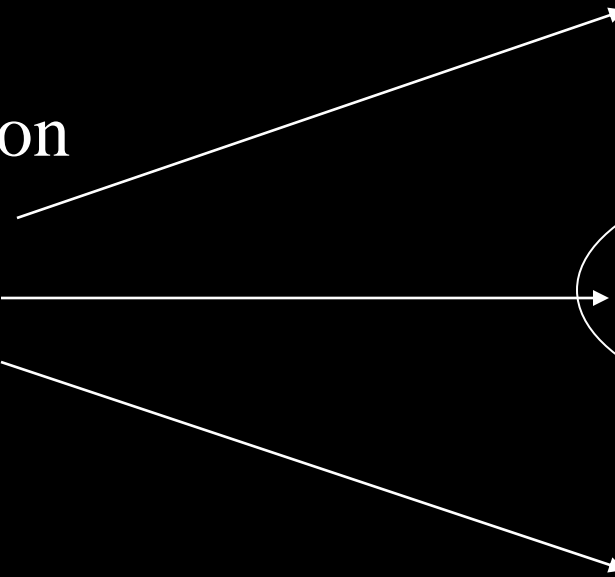

CALIBRATION STATUS

$$N_{freon} = f(T, E_{photon})$$

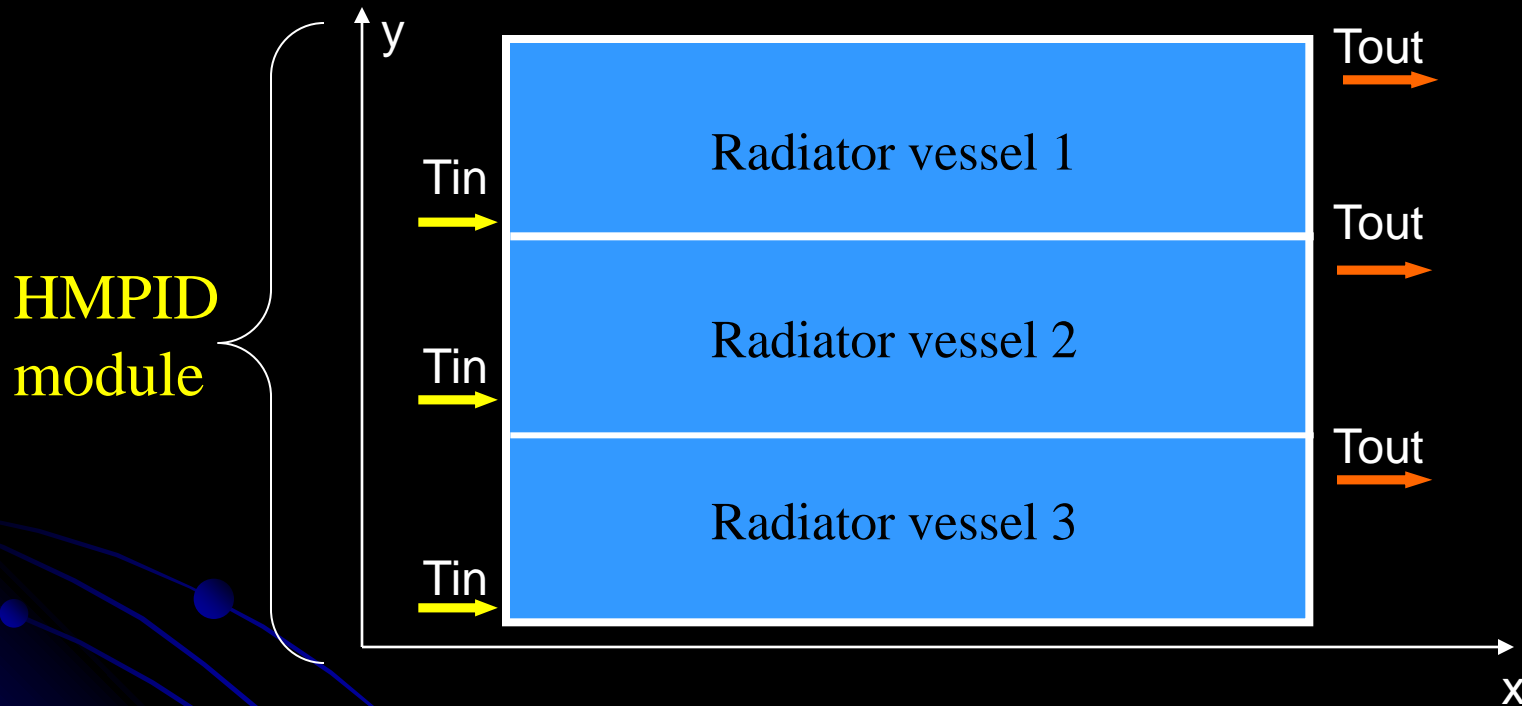

- From DCS by the SHUTTLE T_{in} and T_{out} values are retrieved;
- In the preprocessor $T_{in}(\text{time})$ and $T_{out}(\text{time})$ (42 TF1 objects) are created and stored in the OCDB (Calib/Nmean);
- Assuming the temperature uniform long x direction and a linear gradient long y direction, radiator temperature for a given impact track point is calculated.

CALIBRATION STATUS

- ❑ An inconsistency has been found: Outlet C_6F_{14} temperature is smaller than the inlet one!!! **NOT EXPECTED!!!**
- ❑ Temperature sensor are not placed in the best position to measure the **real C_6F_{14} temperature inside the radiator vessels!!!**
- ❑ Code modification needed to take into account this problem
 - ❑ Further calibration of the radiator temperature is needed.

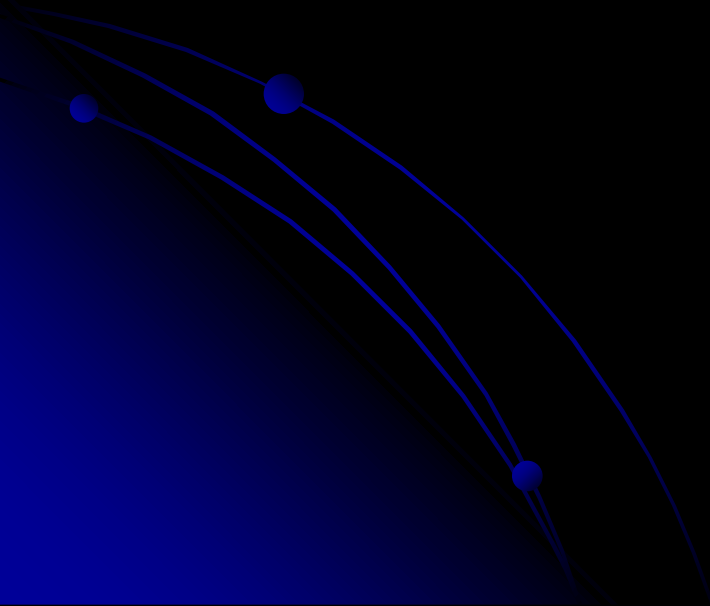

DQM status

- Dedicated HMPID agent is only used for debugging;
- HMPID DQM is now offline QA based (shifter agent)
- Sample plots for:
 - Physics and technical runs
 - Typical problems (HV trip, masked DDL, corrupted data)
- Documentation is available at the DQM twiki page.

HMP data size per ddl

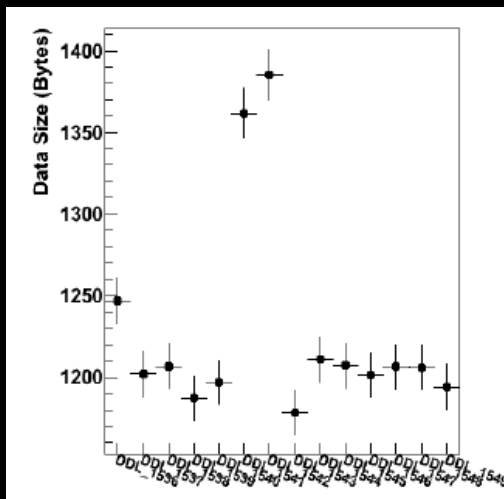

HMP average pad occupancy per ddl

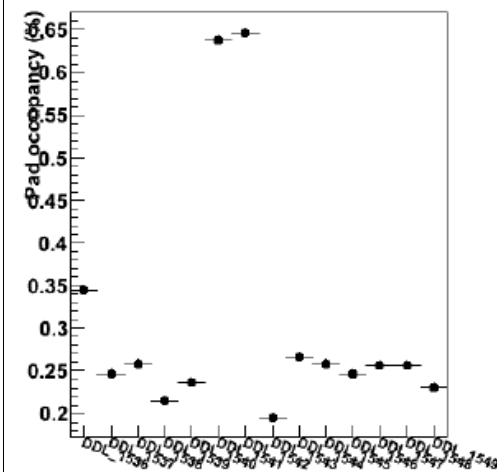

HMP sum Q maps

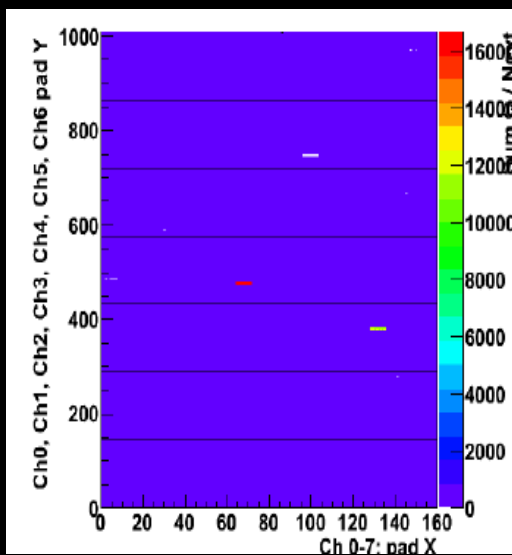

HMP HV sector vs Q

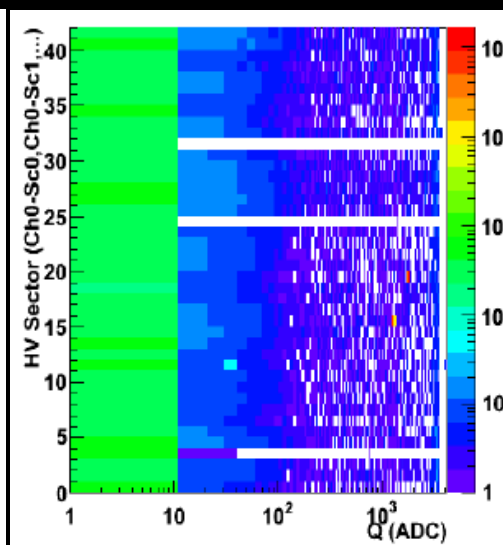

DQM status: to do

• p-p run:

- Use QA shifter agent (fix for scaling is in release)
- Finalize QA checker
- Use QA reference: real data

• HI run:

- Use dedicated agent (create light weight dedicated shifter agent?)
- Understand detector & create QA reference
- Change to QA shifter agent

Some results from LHC10b data (pass2)

$0.5 \text{ GeV}/c < p < 0.75 \text{ GeV}/c$

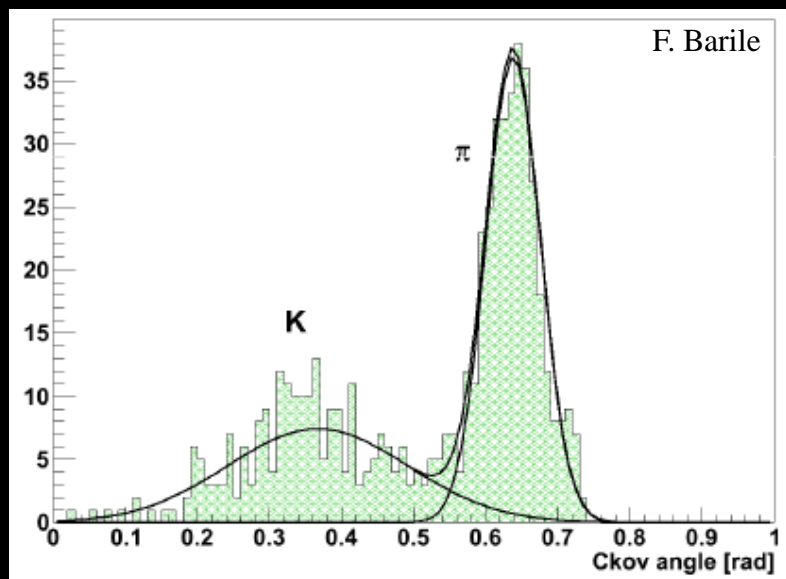

$1.5 \text{ GeV}/c < p < 1.75 \text{ GeV}/c$

