

A Journey from the Infinitely Big to the Infinitely Small

Cristiano Alpigiani



- Conference will start shortly
- Switch off camera and microphone
- Open the *chat* tool (down-right)

Your Virtual Conference

Format

- Presentation (~45 minutes in total)
- Questions and answers (20 minutes in total)
- But please ask questions also during it!

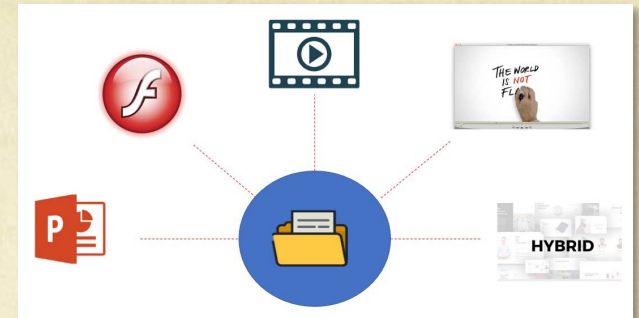

During presentation

- Ask questions using the chat
- Use microphone or camera only if needed



After presentation

- Please fill out survey on Indico page
- Material and links available on Indico page

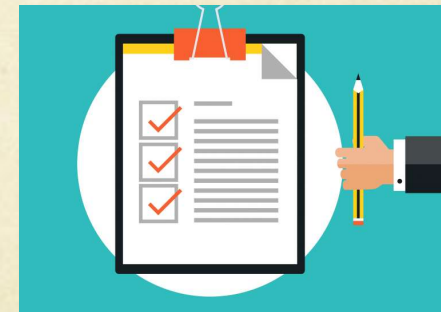

The conference is a general presentation about CERN, its organization, the research, people behind the scenes, etc. All scheduled conferences will have the same format

I am...

- A **particle physicist** working in the ATLAS experiment
- I am looking for Physics Beyond the Standard Model (mainly **long-lived particles**)
- I am searching for particles from the **Dark/Hidden Sector**

ATLAS



MATHUSLA

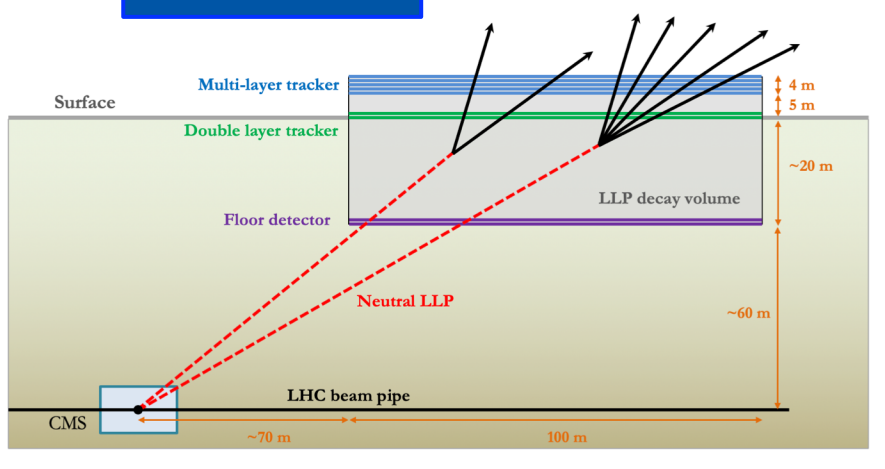

- I am also working on a proposal for a future (big) experiment searching for **very long-lived particles** and **cosmic rays**

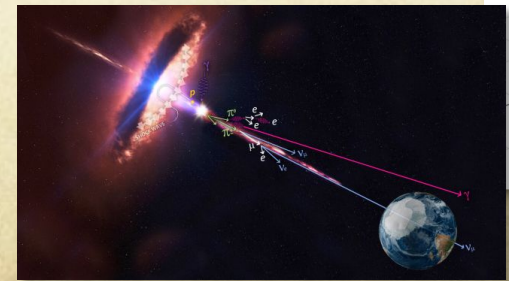
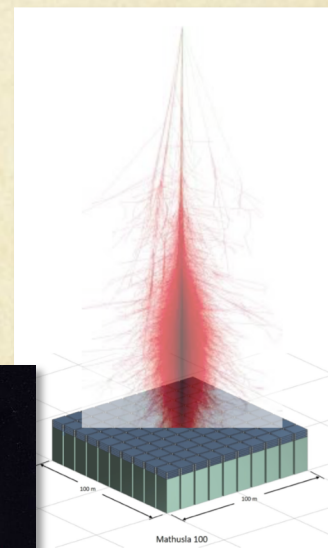

CERN

Conseil
Européen pour la
Recherche
Nucléaire

1953

Organisation
Européenne pour la
Recherche
Nucléaire

1954

23 Member States

Budget (2020)

- ~1.2 billion CHF
- ~1.1 miliardi EUR
- ~1.0 billion GBP
- ~1.2 billion USD



 Austria (1959)	 Sweden (1953)
 Belgium (1953)	 Switzerland (1953)
 Bulgaria (1999)	 United Kingdom (1953)
 Czech Republic (1993)	States in accession to Membership and Associate Members
 Denmark (1953)	 Croatia (2019)
 Finland (1991)	 Cyprus (2016)
 France (1953)	 India (2017)
 Germany (1953)	 Lithuania (2018)
 Greece (1953)	 Pakistan (2015)
 Hungary (1992)	 Slovenia (2017)
 Israel (2014)	 Turkey (2015)
 Italy (1953)	 Ukraine (2016)
 Netherlands (1953)	
 Norway (1953)	
 Poland (1991)	
 Portugal (1986)	
 Romania (2016)	
 Serbia (2019)	
 Slovakia (1993)	
 Spain (1961-1968, 1983-)	



A World Collaboration!

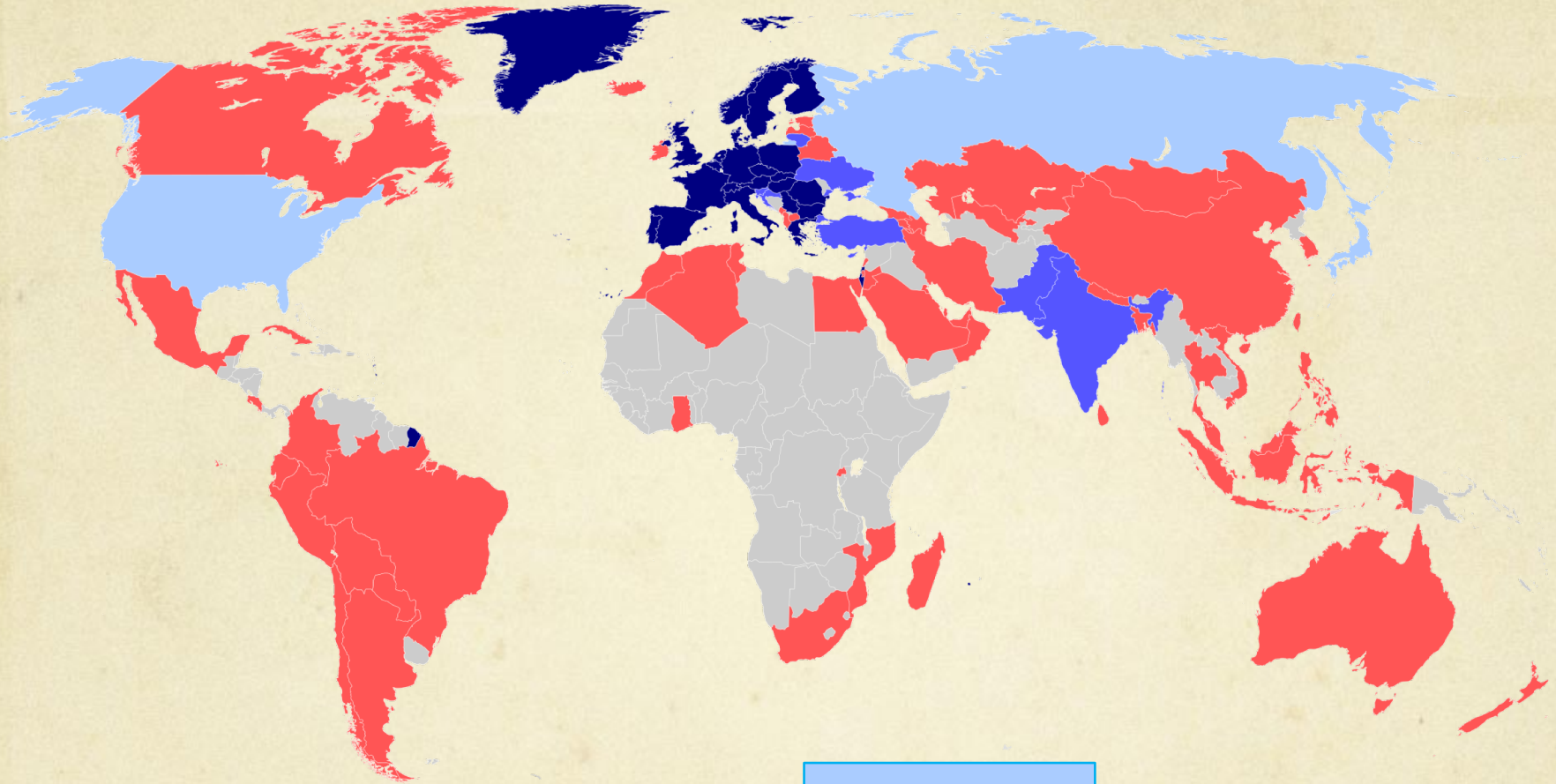

23 members

3 observers

8 associated

61 with agreements

How Many Persons Are Working at CERN?

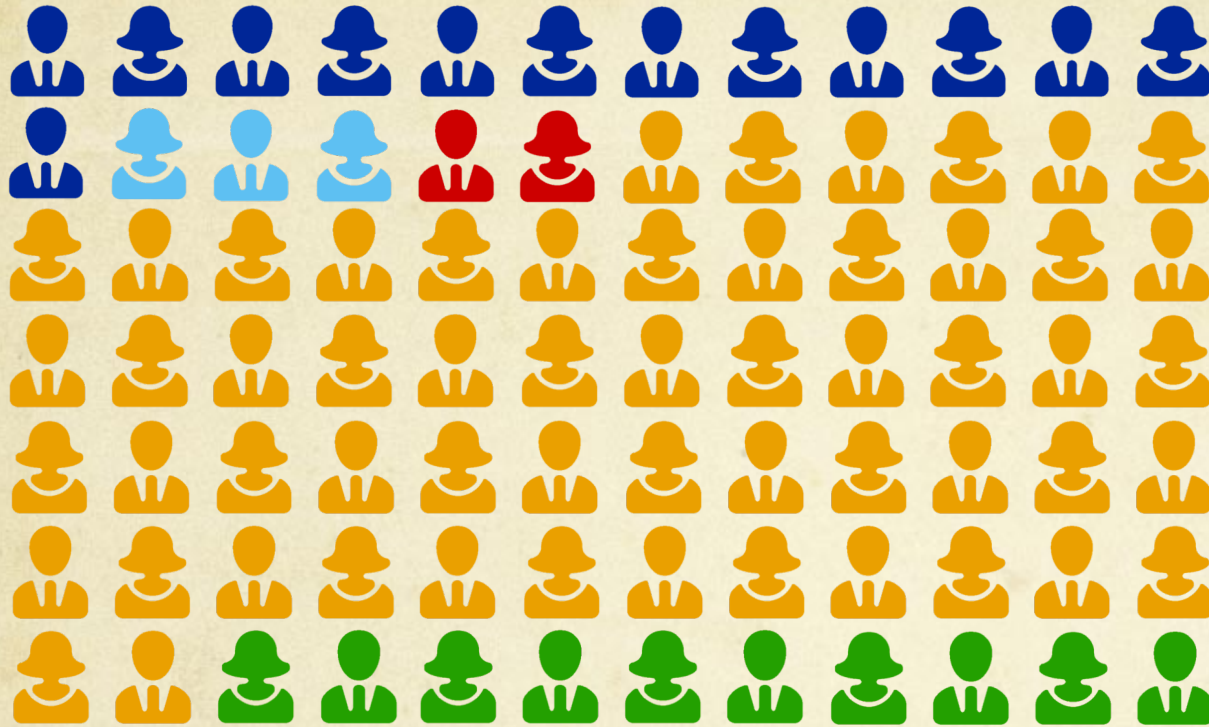

2 600 staff

800 fellows

apprentices

550 students

15 000 users

2 000 external
companies

Total ~20 000!

A small town...



Cristiano Alpighiani

Many Open Questions...Still Waiting for an Answer

The matter-antimatter asymmetry

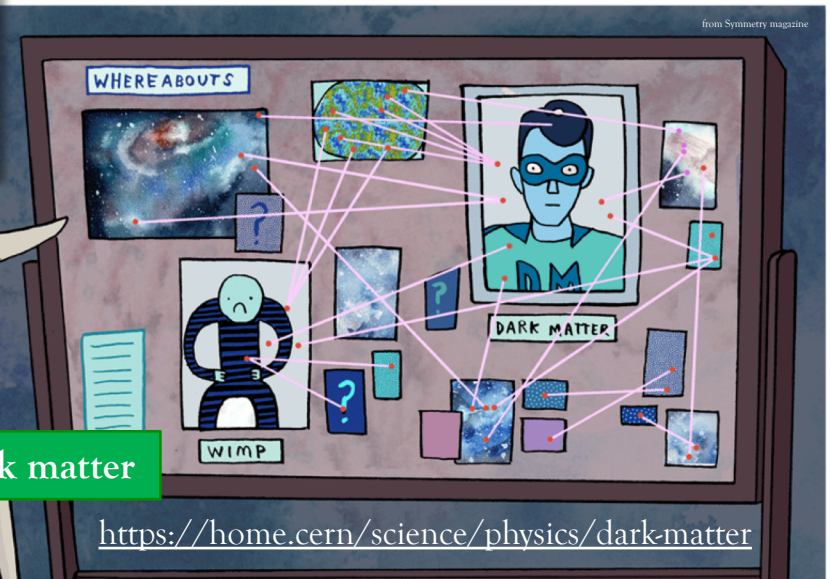
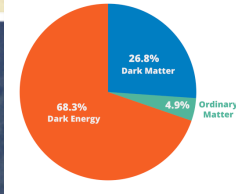
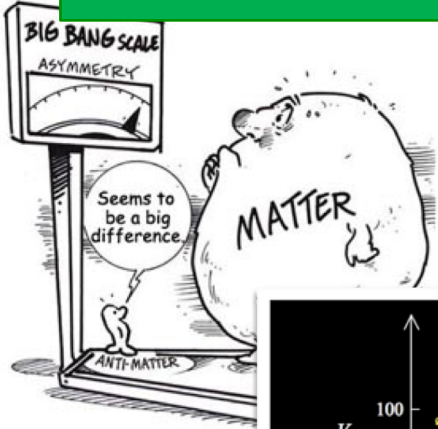

The dark matter

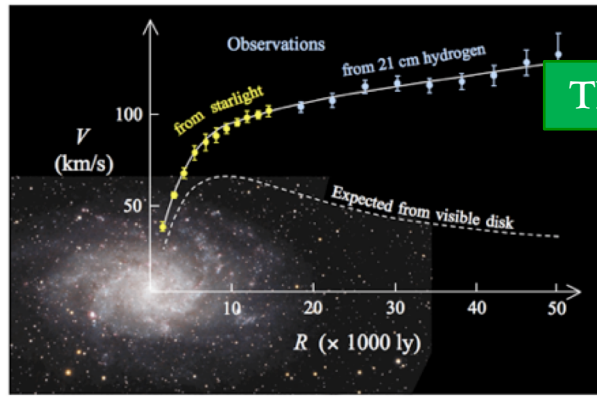

The mass of the neutrinos

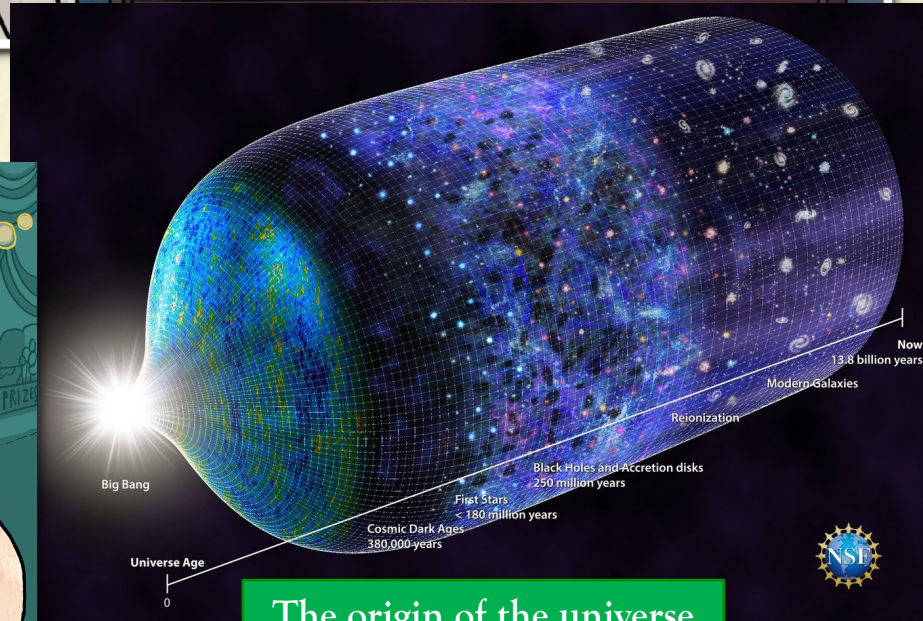

The origin of the universe

Cristiano Alpighiani



What is Matter Made of?

The Standard Model of particle physics

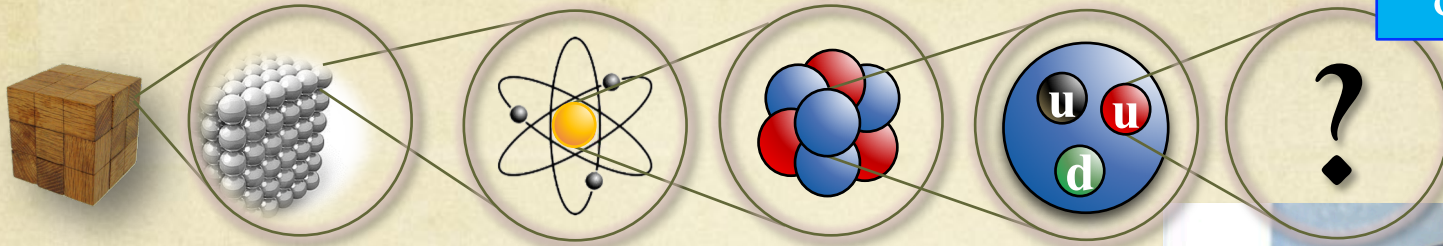

	three generations of matter (fermions)			interactions / force carriers (bosons)	
	I	II	III		
mass	≈2.2 MeV/c ²	≈1.28 GeV/c ²	≈173.1 GeV/c ²	0	≈124.97 GeV/c ²
charge	2/3	2/3	2/3	0	0
spin	1/2	1/2	1/2	1	0
	u up	c charm	t top	g gluon	H higgs
	d down	s strange	b bottom	γ photon	
	e electron	μ muon	τ tau	Z Z boson	
	ν_e electron neutrino	ν_μ muon neutrino	ν_τ tau neutrino	W W boson	

QUARKS

LEPTONS

SCALAR BOSONS

GAUGE BOSONS
VECTOR BOSONS

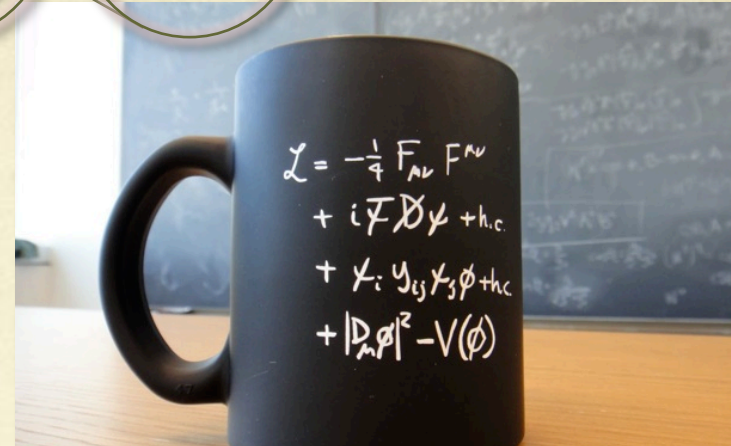

The most comprehensive theory of nature...up to now...

Gravity currently not fitting this "scheme"



[Video on CERN YouTube channel](#)
[More on the Standard Model](#)

Many Many Experiments...

The 4 LHC giants

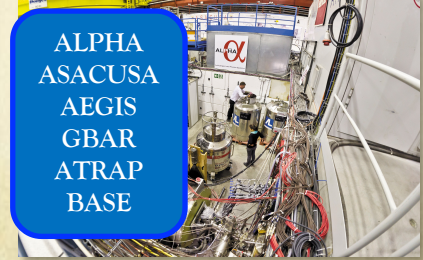
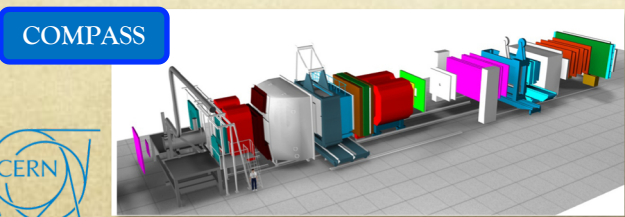
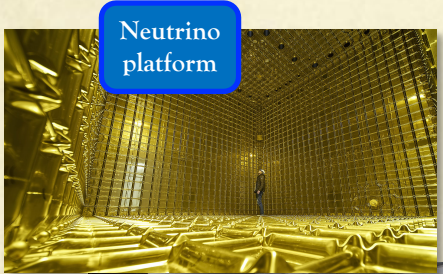
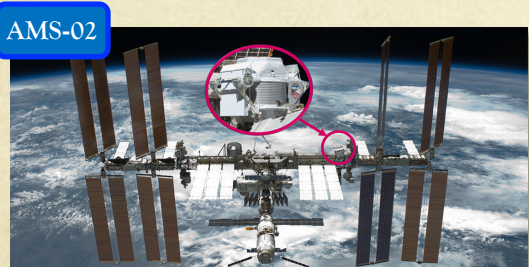
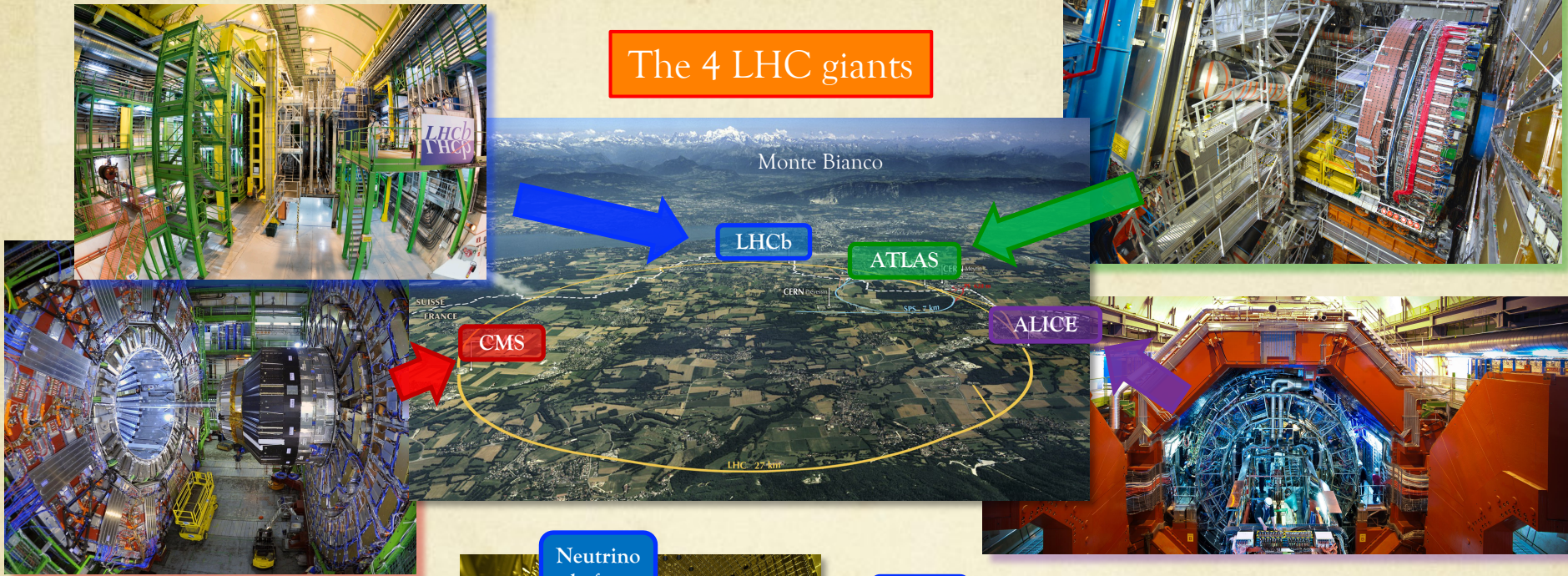

Cristiano Alpigiani

And many more...

But We Have to Accelerate Particles...

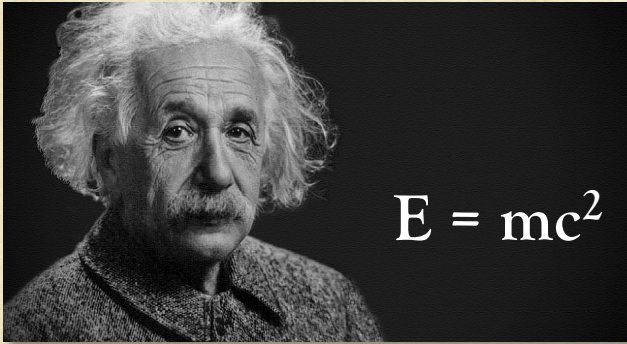

- A particle accelerator is a **super-microscope** to “see” tiny particles (quarks, lepton, etc)
- Accelerators can be used to transform energy into mass (and vice-versa)

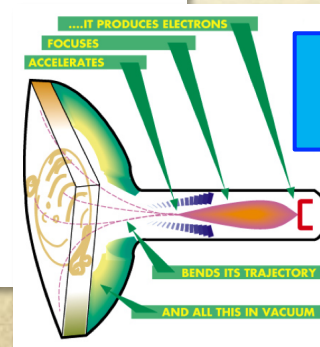
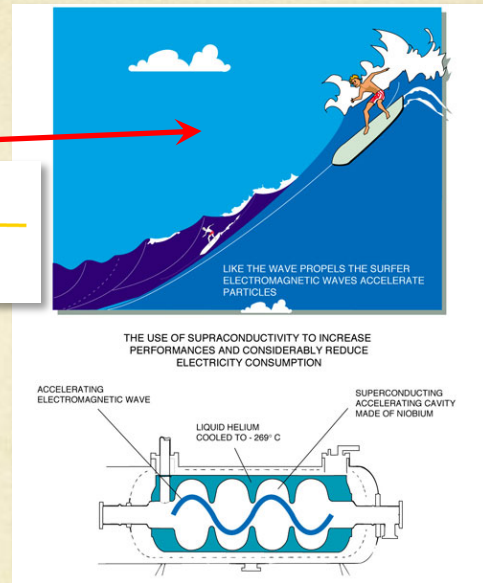
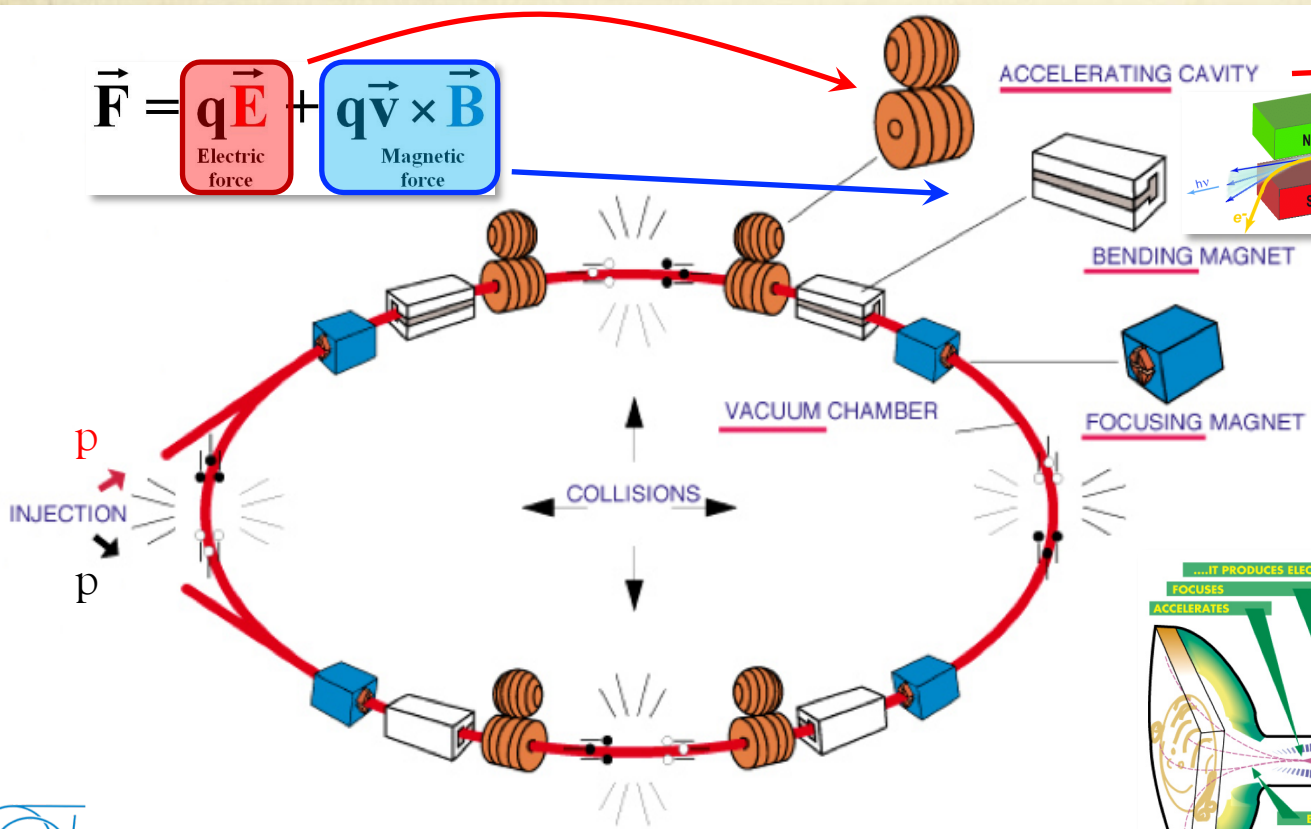

Not so different from an (OLD) TV set...

The CERN Accelerator Complex

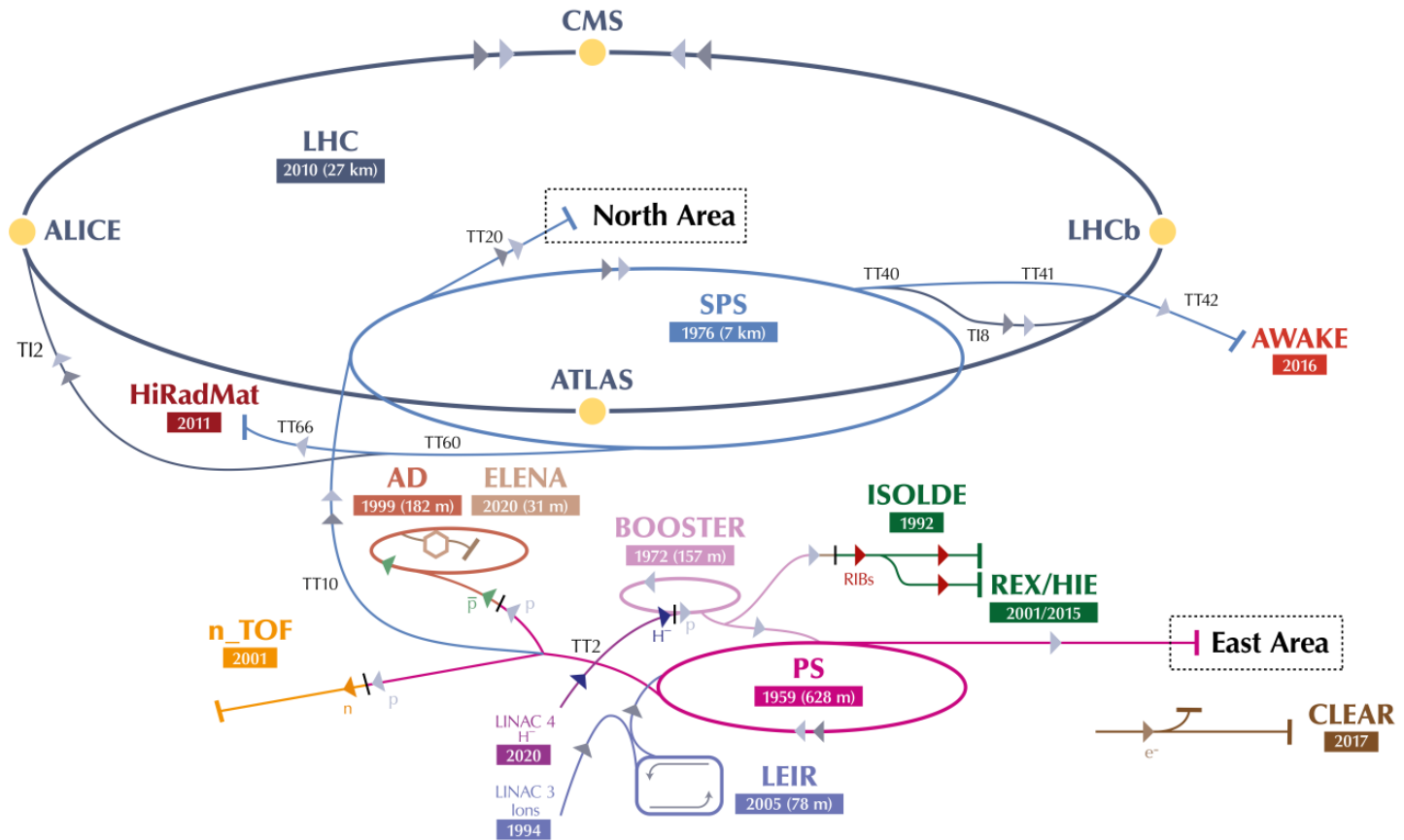

▶ H^- (hydrogen anions) ▶ p (protons) ▶ ions ▶ RIBs (Radioactive Ion Beams) ▶ n (neutrons) ▶ \bar{p} (antiprotons) ▶ e^- (electrons)

LHC - Large Hadron Collider // SPS - Super Proton Synchrotron // PS - Proton Synchrotron // AD - Antiproton Decelerator // CLEAR - CERN Linear Electron Accelerator for Research // AWAKE - Advanced WAKEfield Experiment // ISOLDE - Isotope Separator OnLine // REX/HIE - Radioactive Experiment/High Intensity and Energy ISOLDE // LEIR - Low Energy Ion Ring // LINAC - LINEar ACcelerator // n_TOF - Neutrons Time Of Flight // HiRadMat - High-Radiation to Materials



Where Do we Take the Protons?

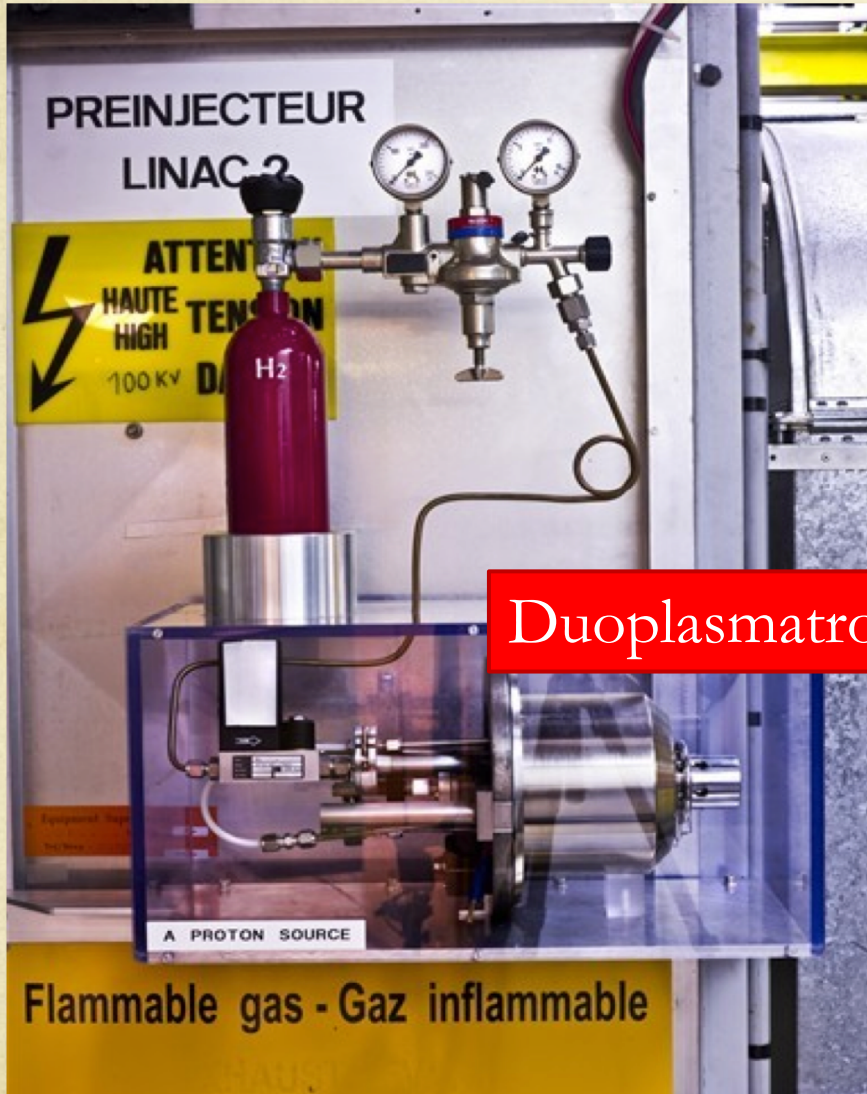

Duoplasmatron

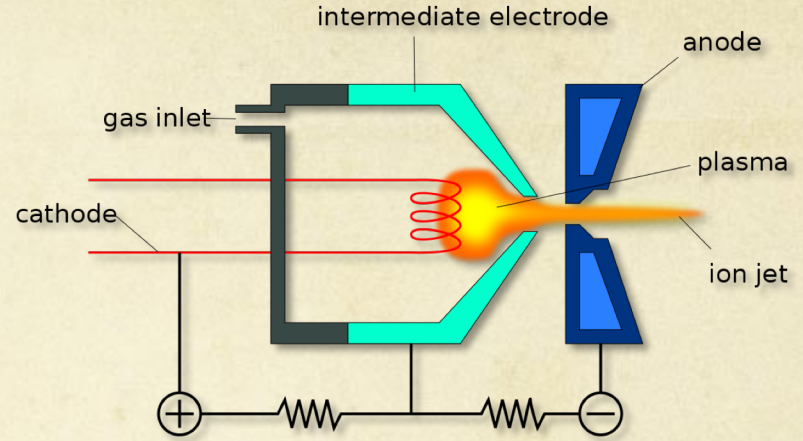

1. Cathode filament emits electrons into a vacuum chamber
2. H_2 gas is introduced in very small
3. Gas become charged or ionised through interactions with the free electrons
4. Plasma is accelerated through a series of charged grids

The Bending Magnets

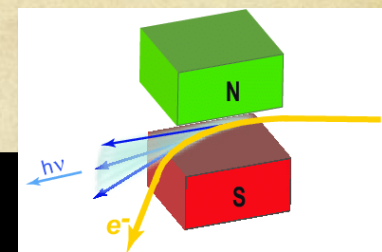

-271 °C (1.9 K)

Niobium-Titanium (Nb-Ti)

$$\vec{F} = q\vec{E} + q\vec{v} \times \vec{B}$$

Electric force Magnetic force

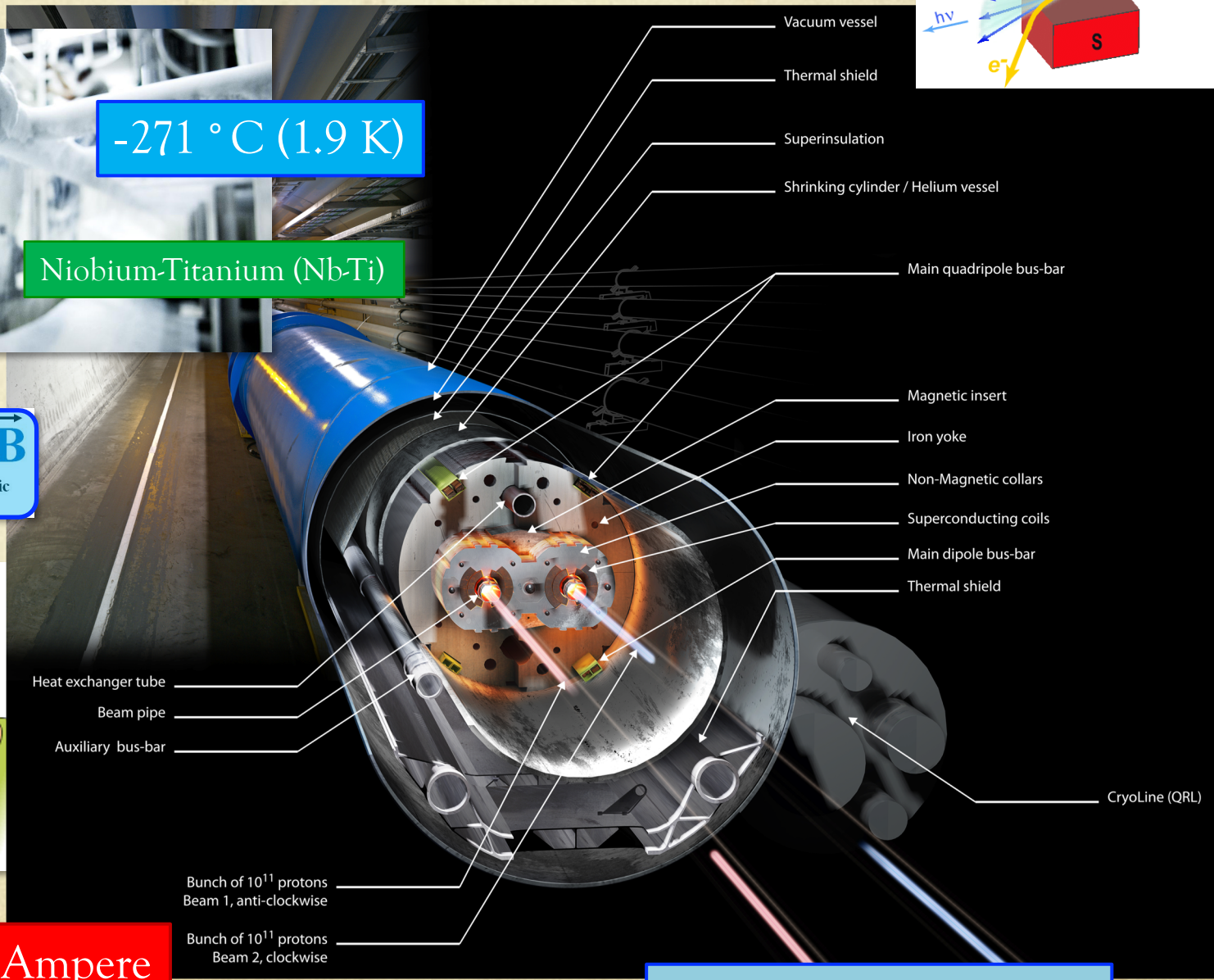
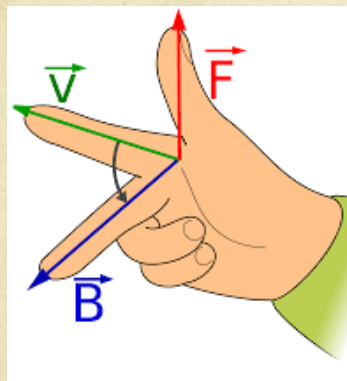

13,000 Ampere

More on superconductivity?

A Very Powerful Camera

ATLAS 

Detector characteristics
Width: 44m
Diameter: 22m
Weight: 7000t

CERN AC - ATLAS V1997

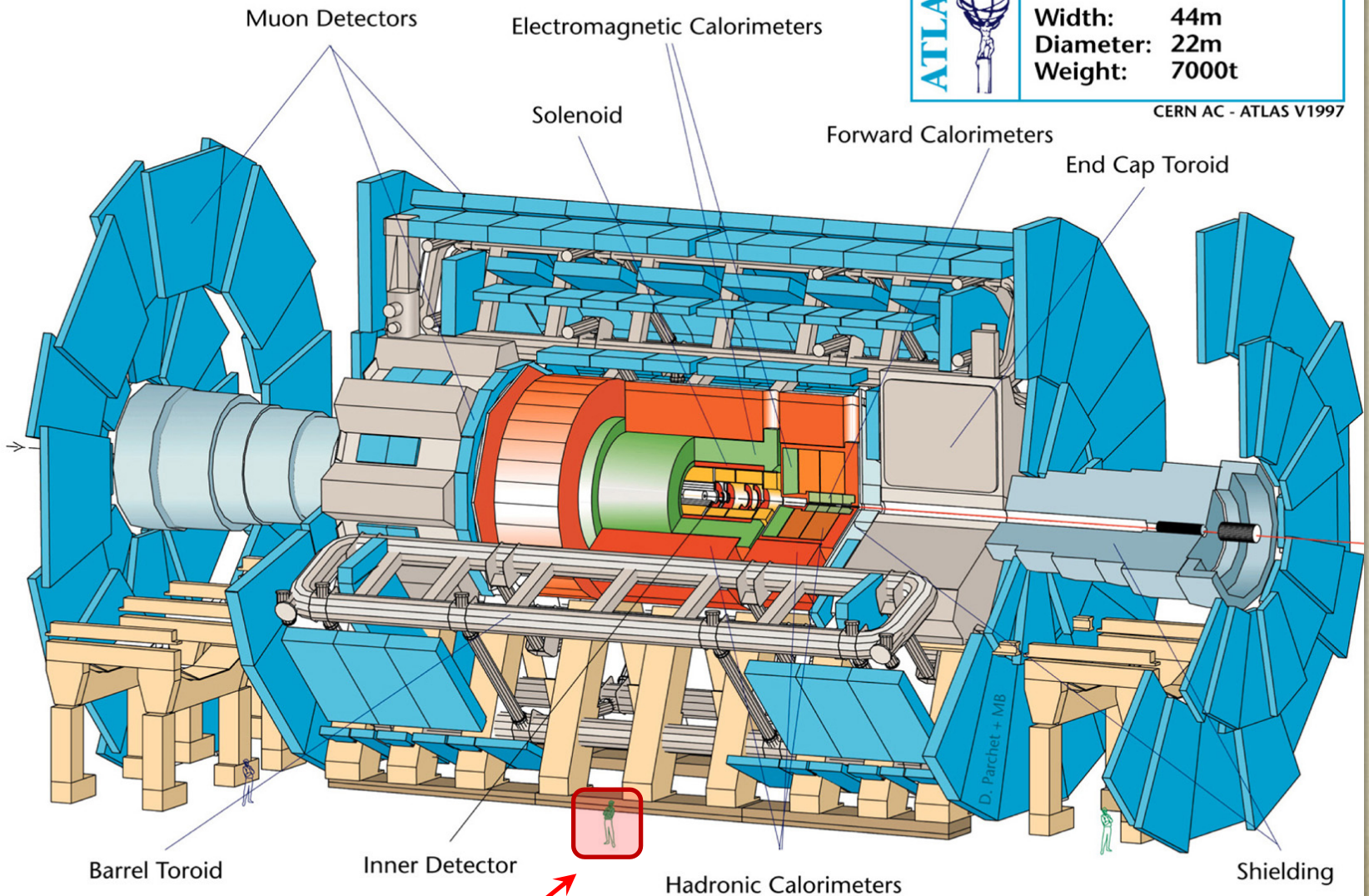

A person...

Cristiano Alpigiani

<https://atlas.cern>

A Very Powerful Camera

A slice of ATLAS

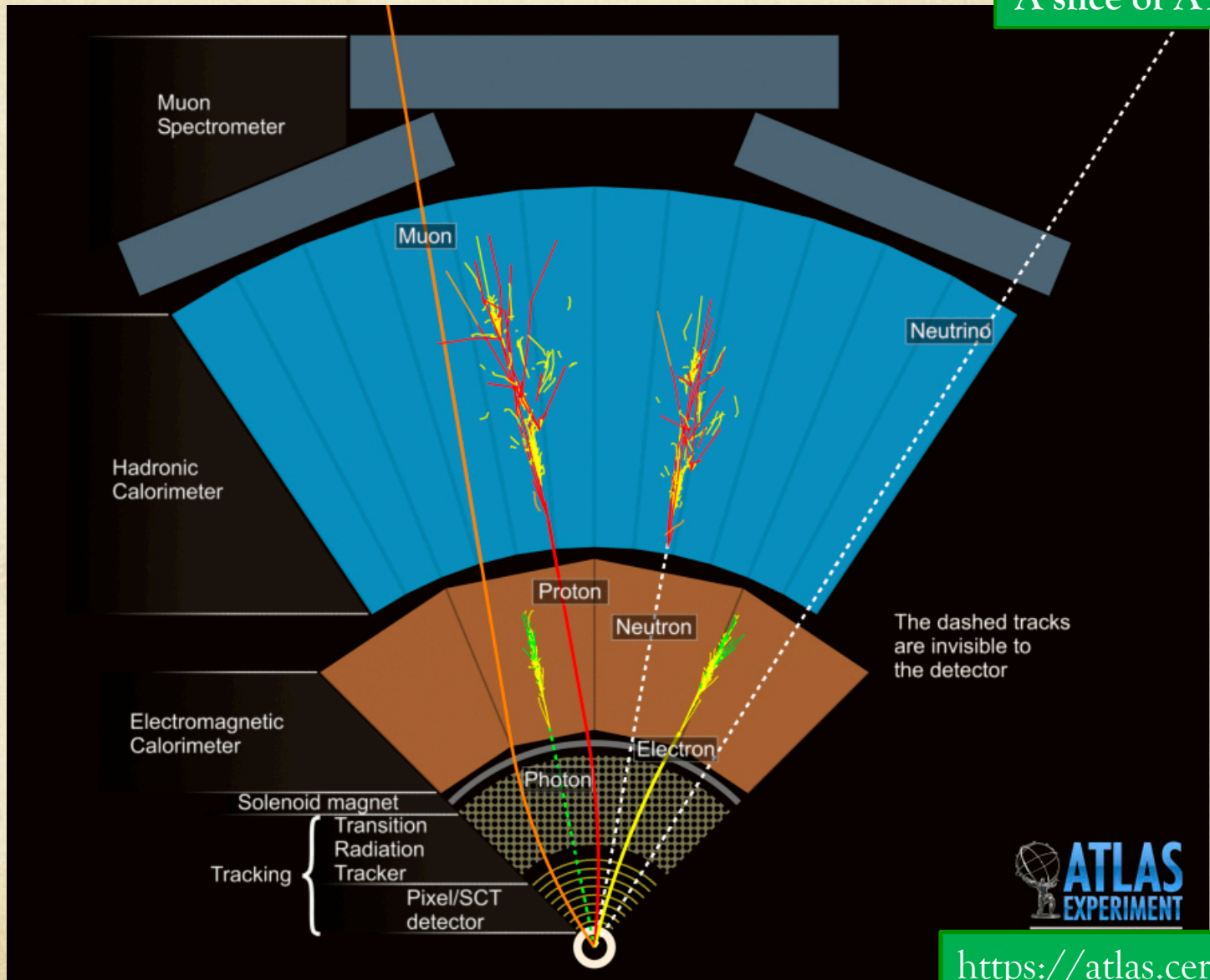

<https://atlas.cern>



The LHC Computing Grid

The largest computing grid

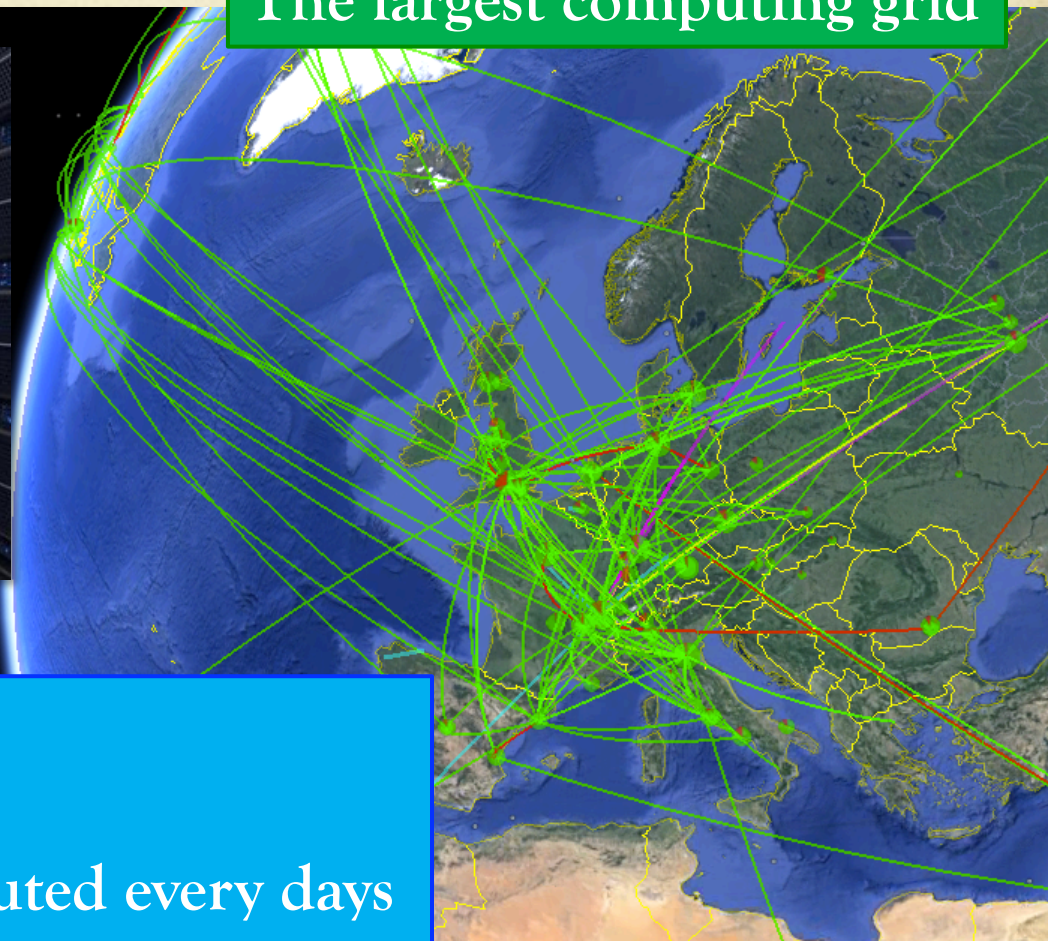
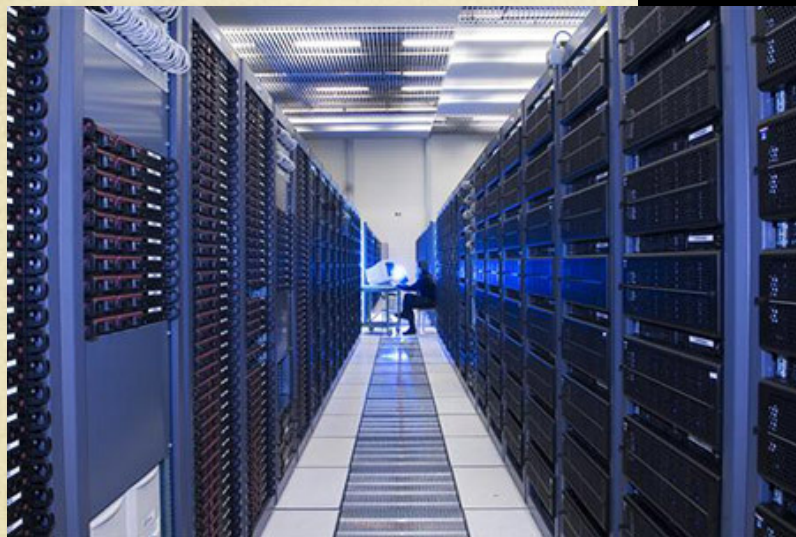

- 42 countries
- 170 data centres
- Over 2 millions tasks executed every days
- 1 million computer cores
- 1 storage exabyte

CERN is Not Only Fundamental Research

Technology transfer in benefit of society

<https://kt.cern/>

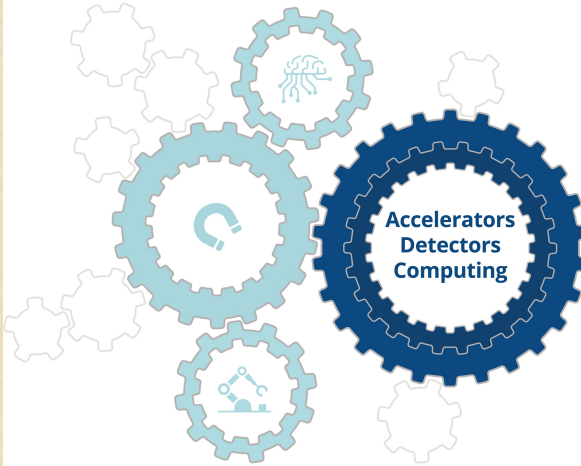

- Medical & Biomedical Technologies
- Aerospace Applications
- Cultural Heritage
- Environment
- Industry 4.0
- Safety
- Emerging Technologies

Medical applications

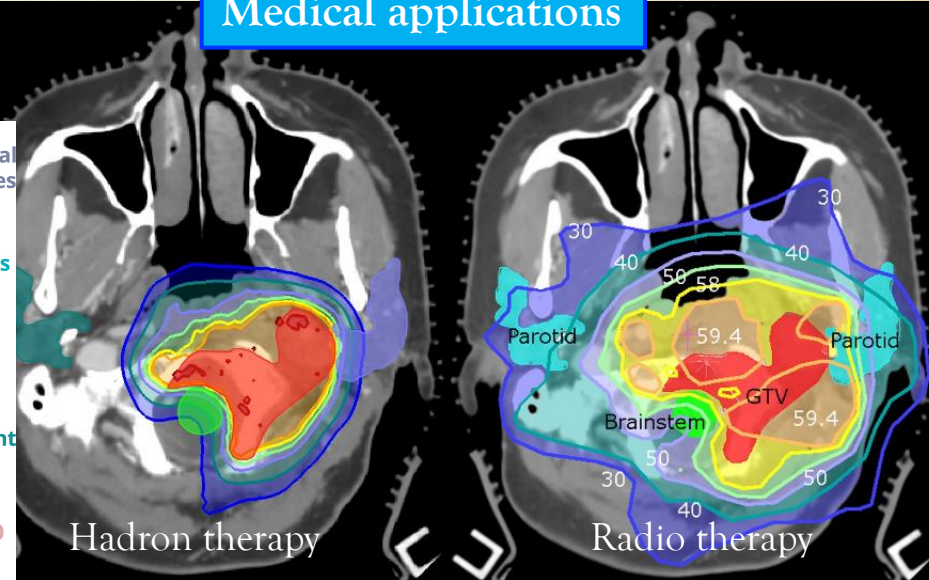

Humanitarian missions



CERN Against COVID

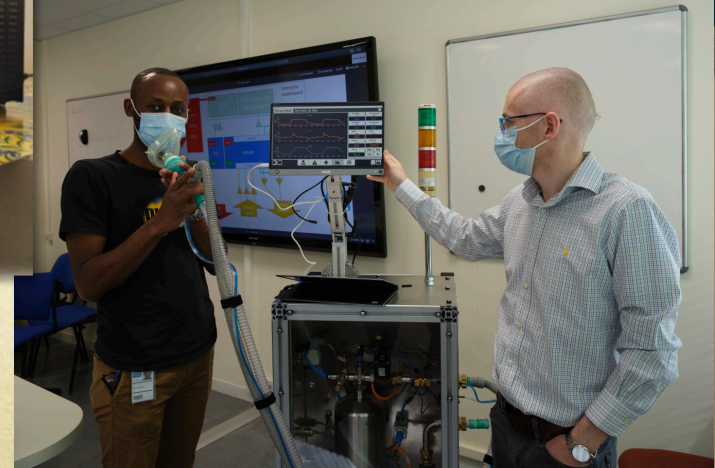
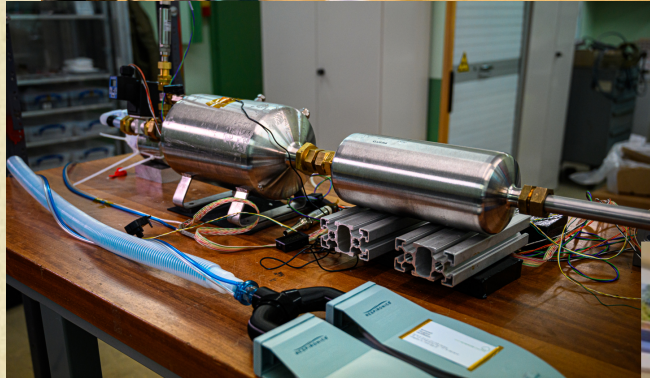

<https://againstcovid19.cern>

Cristiano Alpigiani

CERN Opportunities for Students



- **Many opportunities for a student** (visit <https://careers.cern/students>)
 - Summer Student Programme
 - CERN Openlab Summer Student Programme
 - Short-term Internship Programme
 - Doctoral Student Programme
 - Marie-Curies PhD positions
 - Technical Student Programme
 - Administrative Student Programme
 - Opportunities reserved for students with disabilities
 - Beamline for Schools → <https://beamlineforschools.cern>

Further Research Material

- Want to play with some LHC data? [CERN Open Data](#)
- Want more photos or outreach material? [CERN Document Server \(Multimedia and Outreach\)](#)
- Want to know more? [Upcoming events @CERN](#) (for general public, but can select a different audience)
- More about CERN history? See [here](#) !
- Art @CERN? See [here](#)!
- Want to “see” particle collisions? [ATLAS event displays](#), [Other event displays](#)
- And much more on <https://home.cern>

Thank you!

BACKUP

Dark Matter / Dark Energy

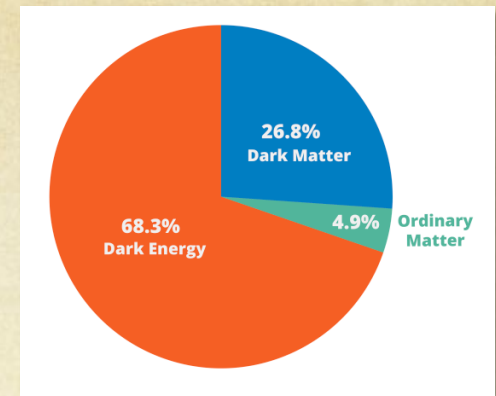

➤ First observed by Fritz Zwicky → velocity dispersions of galaxies in the Coma cluster (idea neglected for 40 years!)

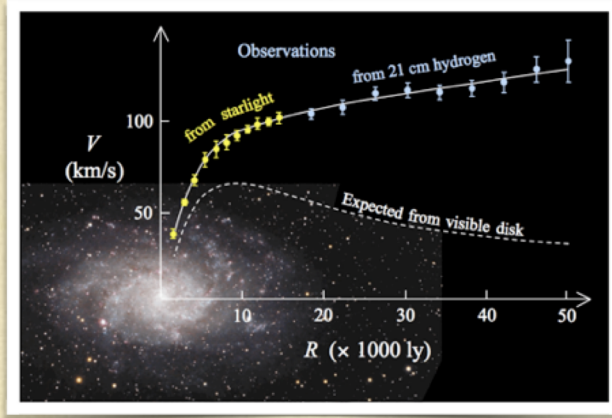

➤ Precisely measured by Vera Rubin → velocity of gas near Andromeda

- Estimated factor of 10 more dark mass than visible mass

Indirect detection: DM-DM annihilation process

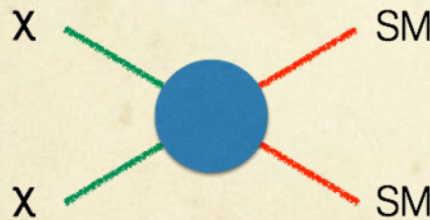
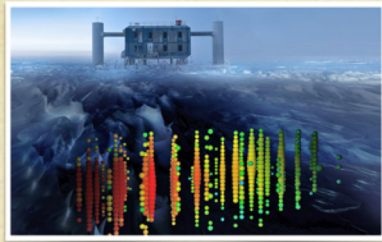

Direct detection: recoil from DM-nucleus scattering

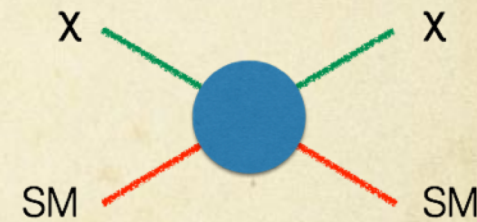
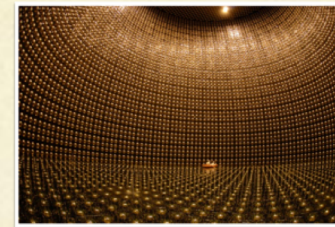

At LHC

- ✓ No DM interaction with the detector → missing E_T
- ✓ Initial state radiation to detect it (jets, photons, W , ...)
- ✓ Searches for high-mass di-jet resonances

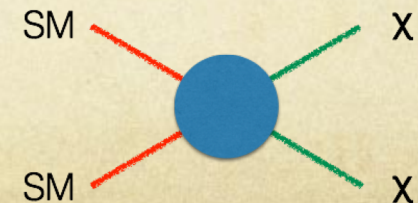

Dark Matter / Dark Energy

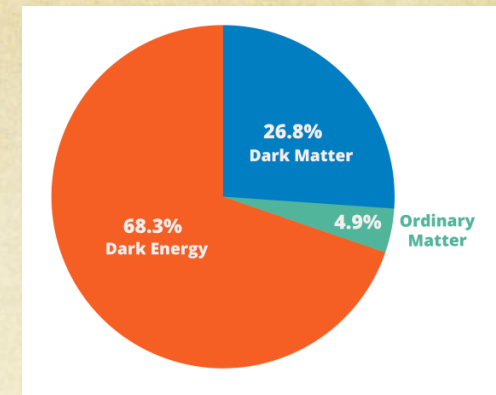
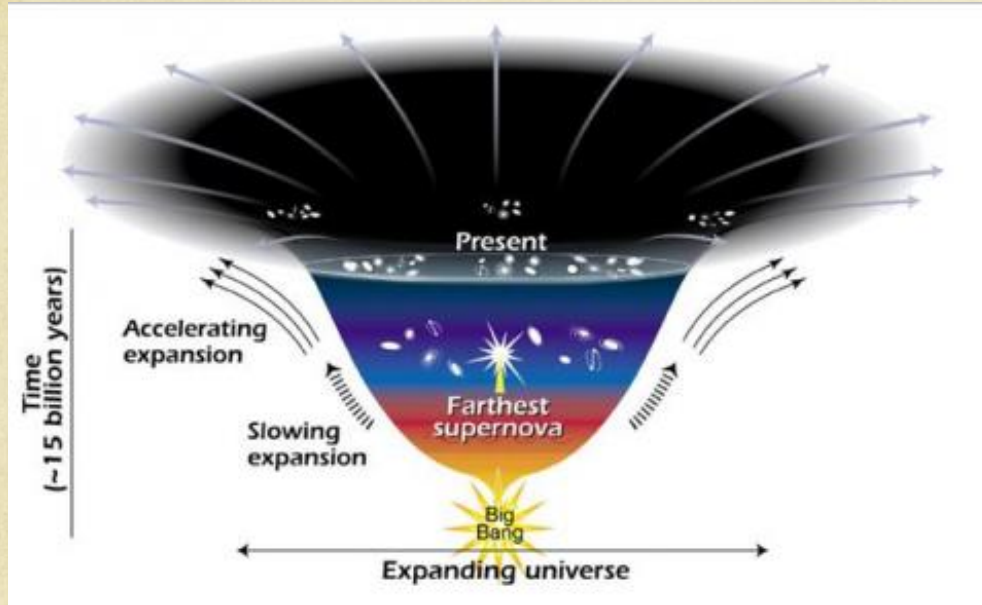

Dark energy is responsible for the acceleration of the Universe expansion

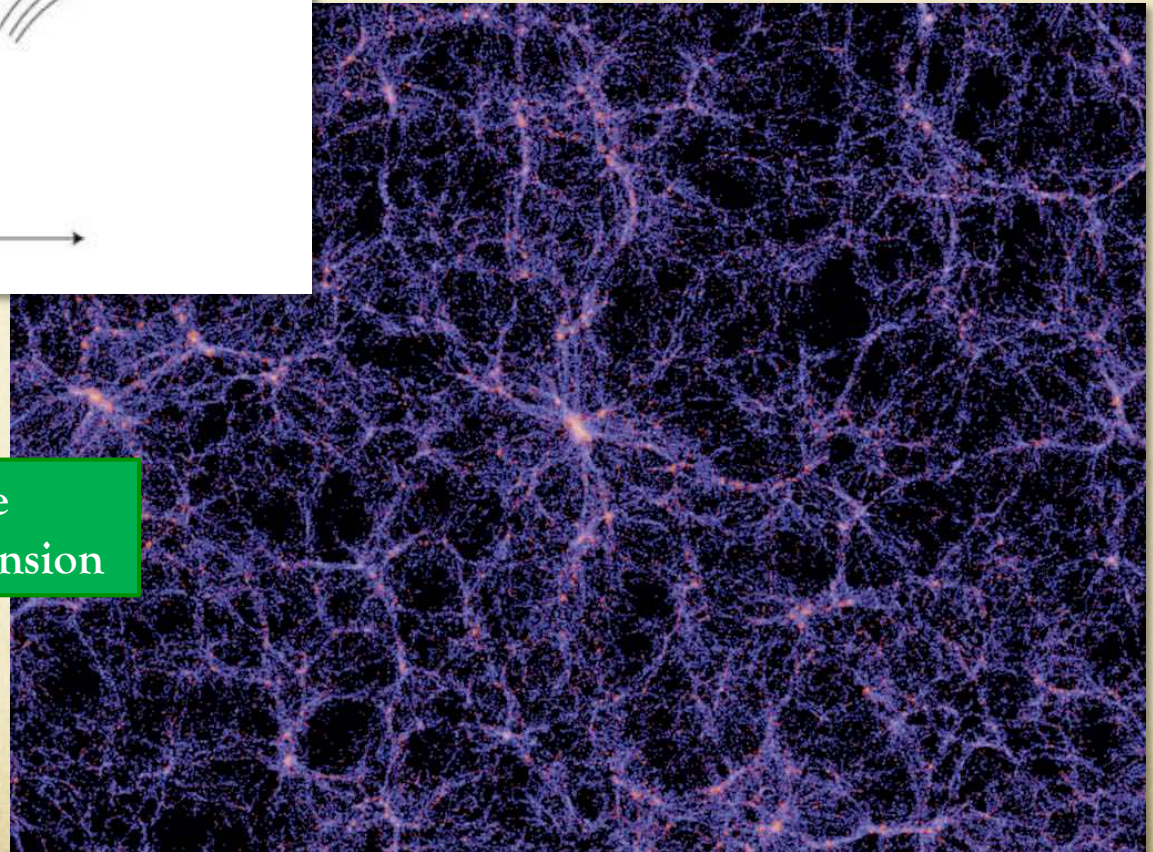

The Bending Magnets

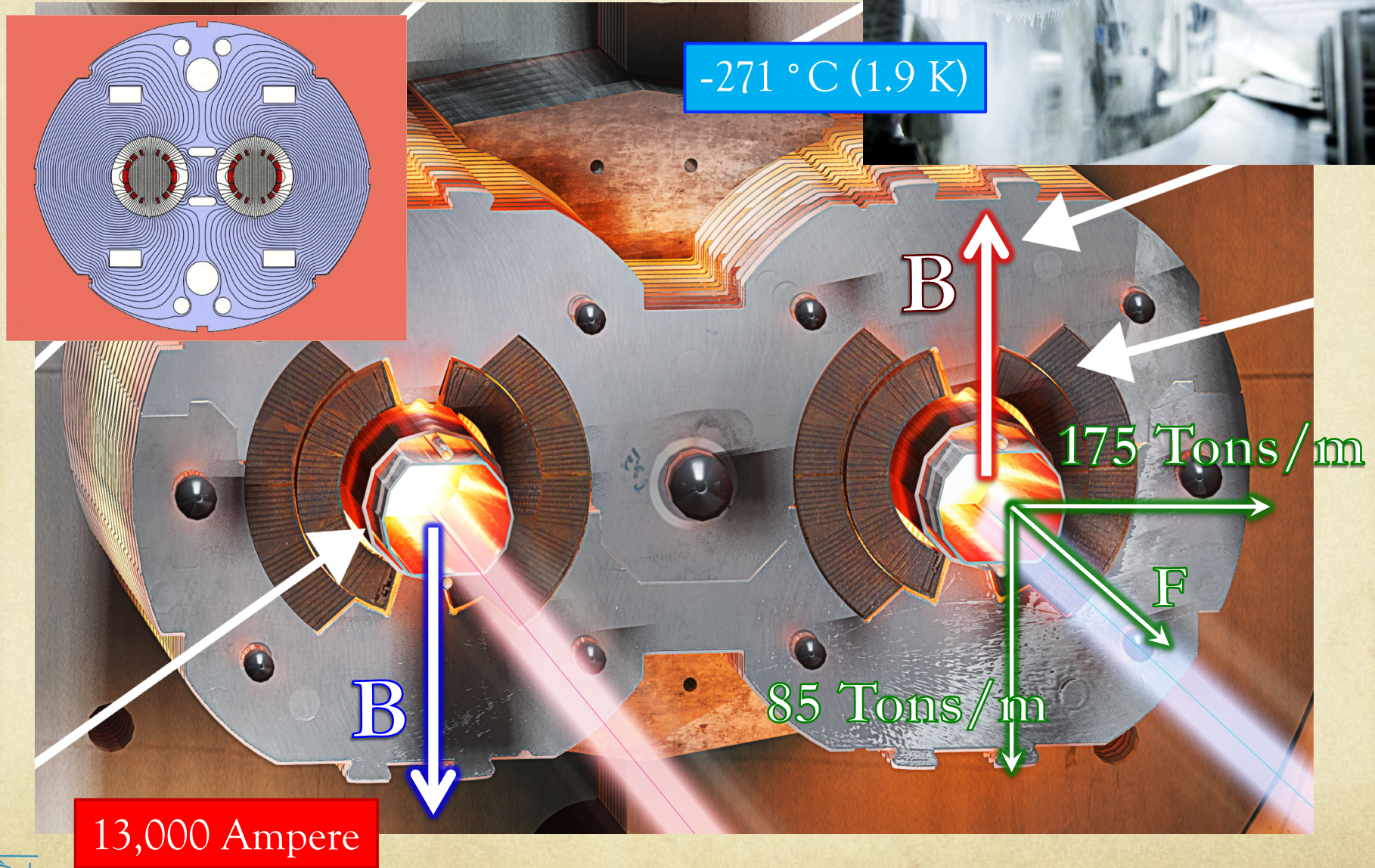

The Superconductors

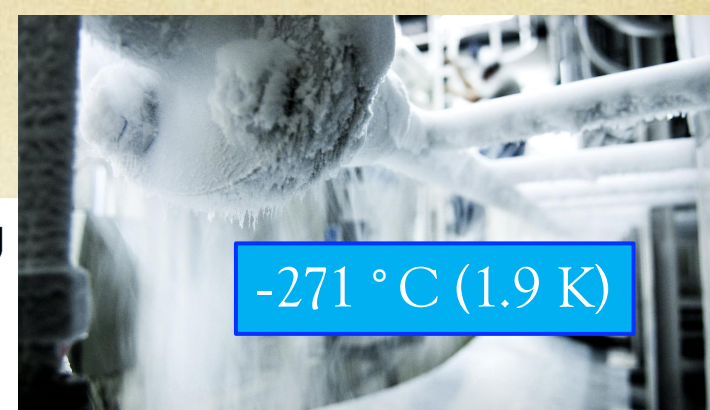

superconducting cable

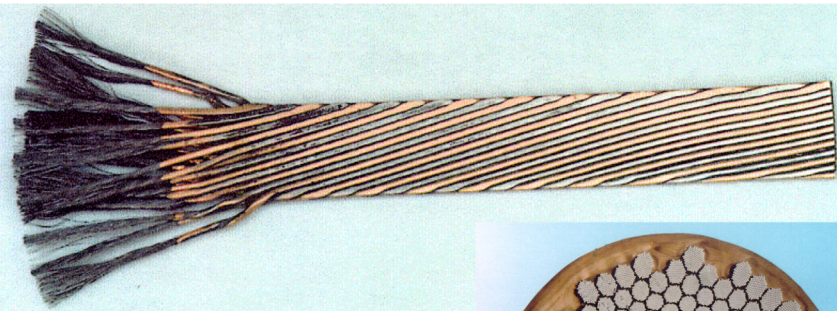

SC strand

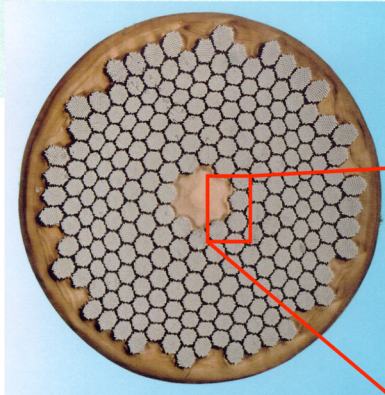

SC filament

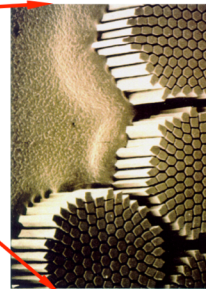

13,000 Ampere

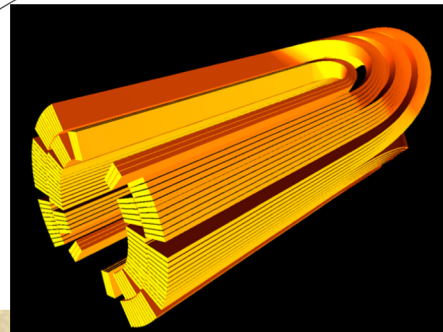
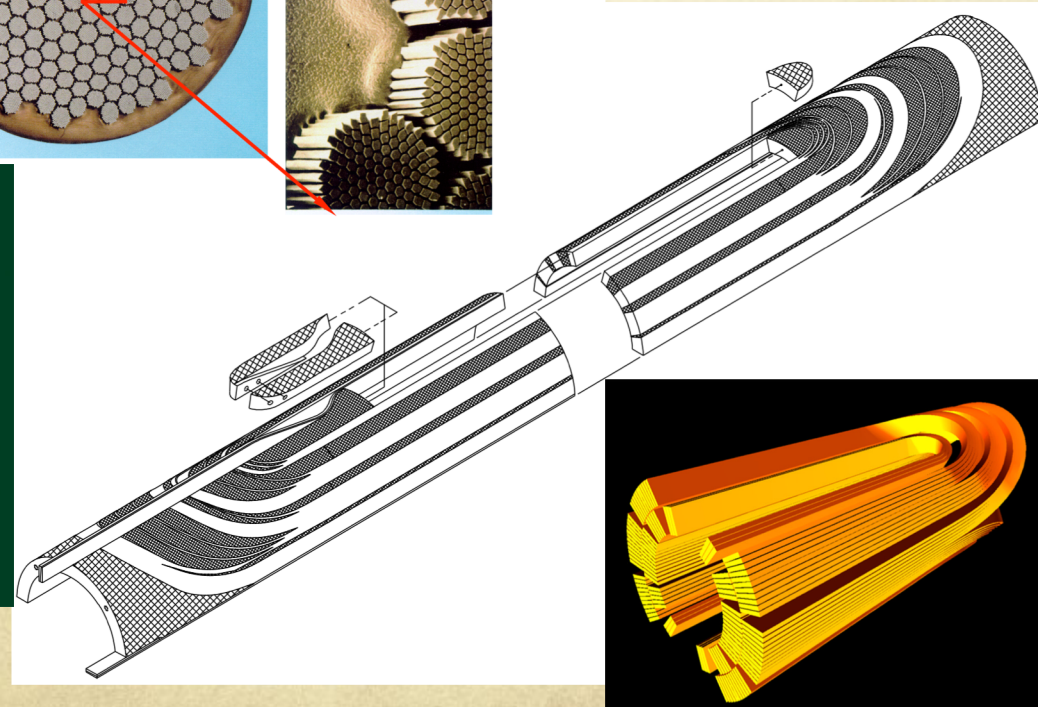
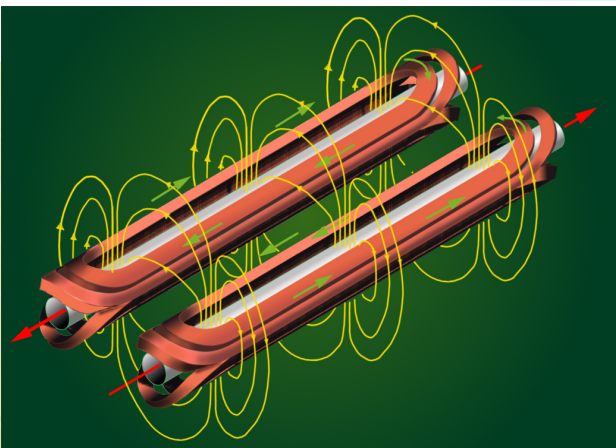

Antimatter

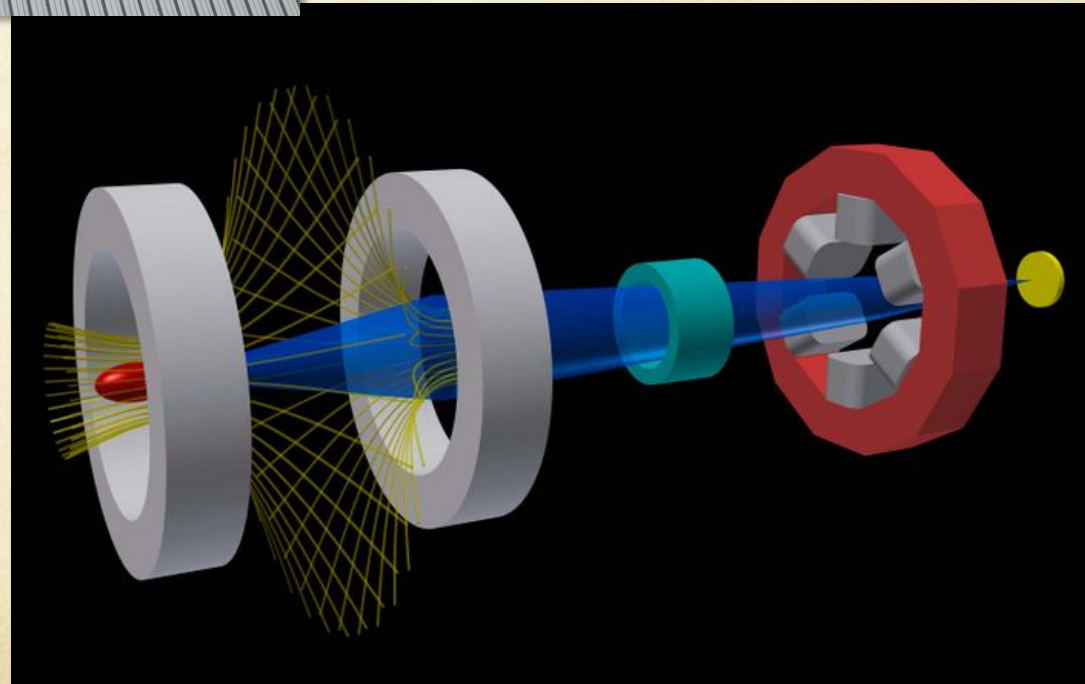
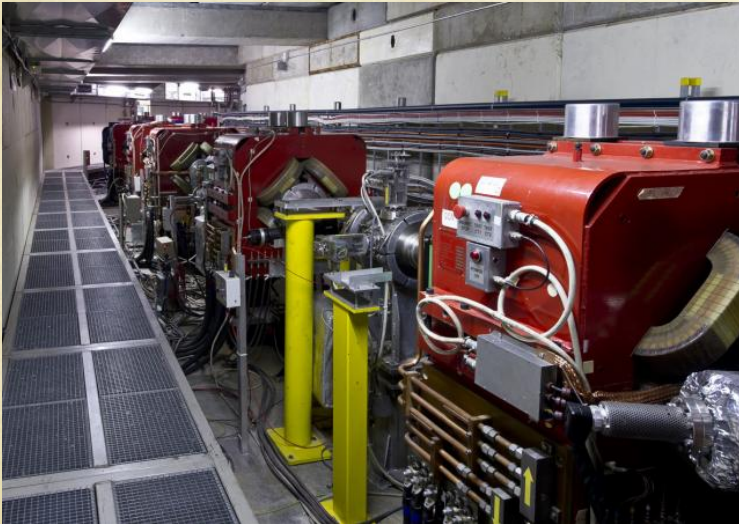
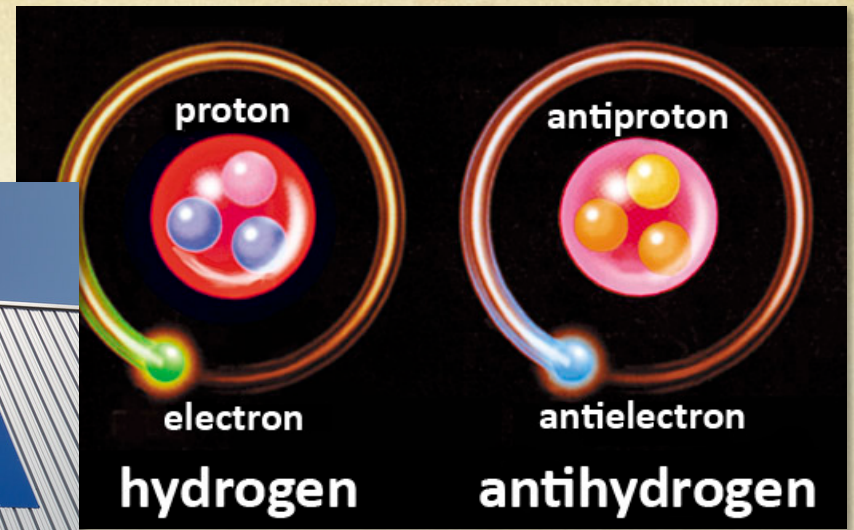

CERN is...

...a scientific laboratory, that devises its own solutions



SCIENCE • TECHNOLOGY • ENGINEERING + ARTS • MATHEMATICS

SCIENCE

- Observing
- Experimenting
- Making predictions
- Asking questions

TECHNOLOGY

- Being inventive
- Using tools
- Making things work
- Identify issues,
- Using computers

ENGINEERING

- Problem solving
- Using materials
- Designing & creating
- Building

ARTS

- Creativity
- Aesthetics
- Imagination
- Expressing individuality

MATH

- Patterning
- Sequencing
- Exploring shapes, numbers, volumes and size