

**On behalf of Katy Foraz,
Head of the EN Department,**

**Welcome
to all of you!**



The Engineering Department in a Nutshell

Katy Foraz



ENGINEERING
DEPARTMENT

Where are we?

CERN: founded in 1954: 12 European States

“Science for Peace”

Today: 23 Member States

Employees: ~2 700 staff, 800 fellows

Associates: ~12 400 users, 1 300 others

Budget (2019) ~ 1 200 MCHF

Member States: Austria, Belgium, Bulgaria, Czech Republic, Denmark, Finland, France, Germany, Greece, Hungary, Israel, Italy, Netherlands, Norway, Poland, Portugal, Romania, Serbia, Slovak Republic, Spain, Sweden, Switzerland and United Kingdom

Associate Members in the Pre-Stage to Membership: Cyprus, Slovenia, Estonia, Latvia

Associate Member States: Croatia, India, Lithuania, Pakistan, Turkey, Ukraine

Applications for Membership or Associate Membership:
Brazil

Observers to Council: Japan, Russia, United States of America;
European Union, JINR and UNESCO

Science is getting more and more global

Distribution of All CERN Users by Location of Institute on 31 December 2019

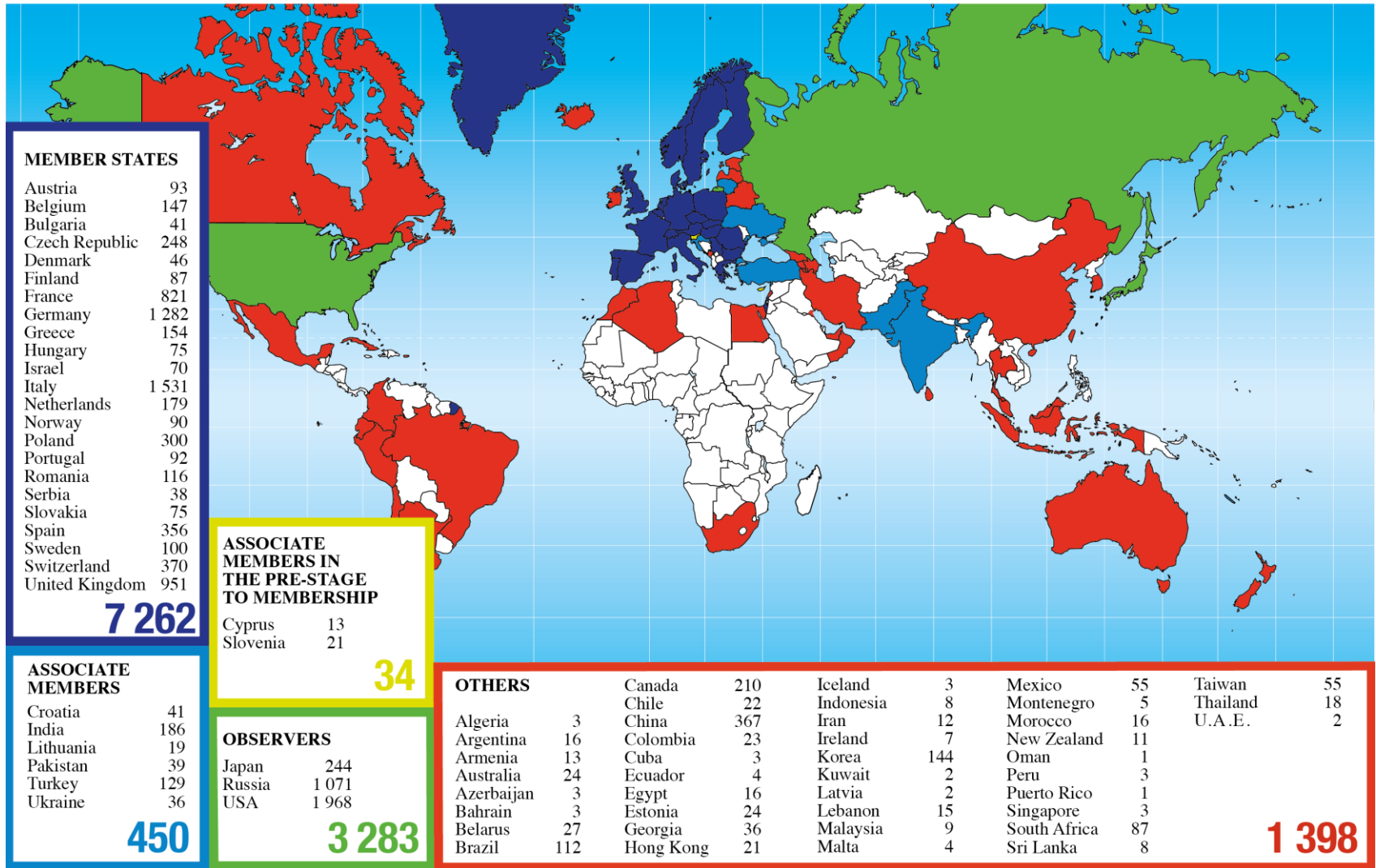

What are we doing?

The Missions of CERN

- Push forward the frontiers of knowledge

e.g. the secrets of the Big Bang ...
what was the matter like within
the first moments of the Universe's existence?

- Develop new technologies for accelerators and detectors

Information technology - the Web and the GRID

Medicine - diagnosis and therapy

- Train the scientists and the engineers of tomorrow
- Unite people from different countries and cultures

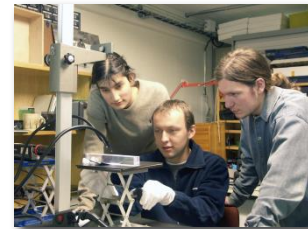
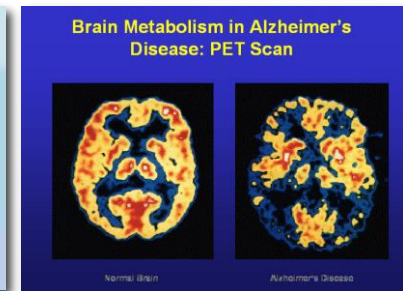
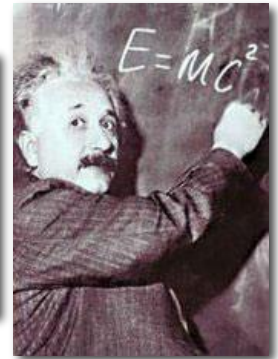

The next scientific challenge is to understand the very first moments of our Universe after the Big Bang

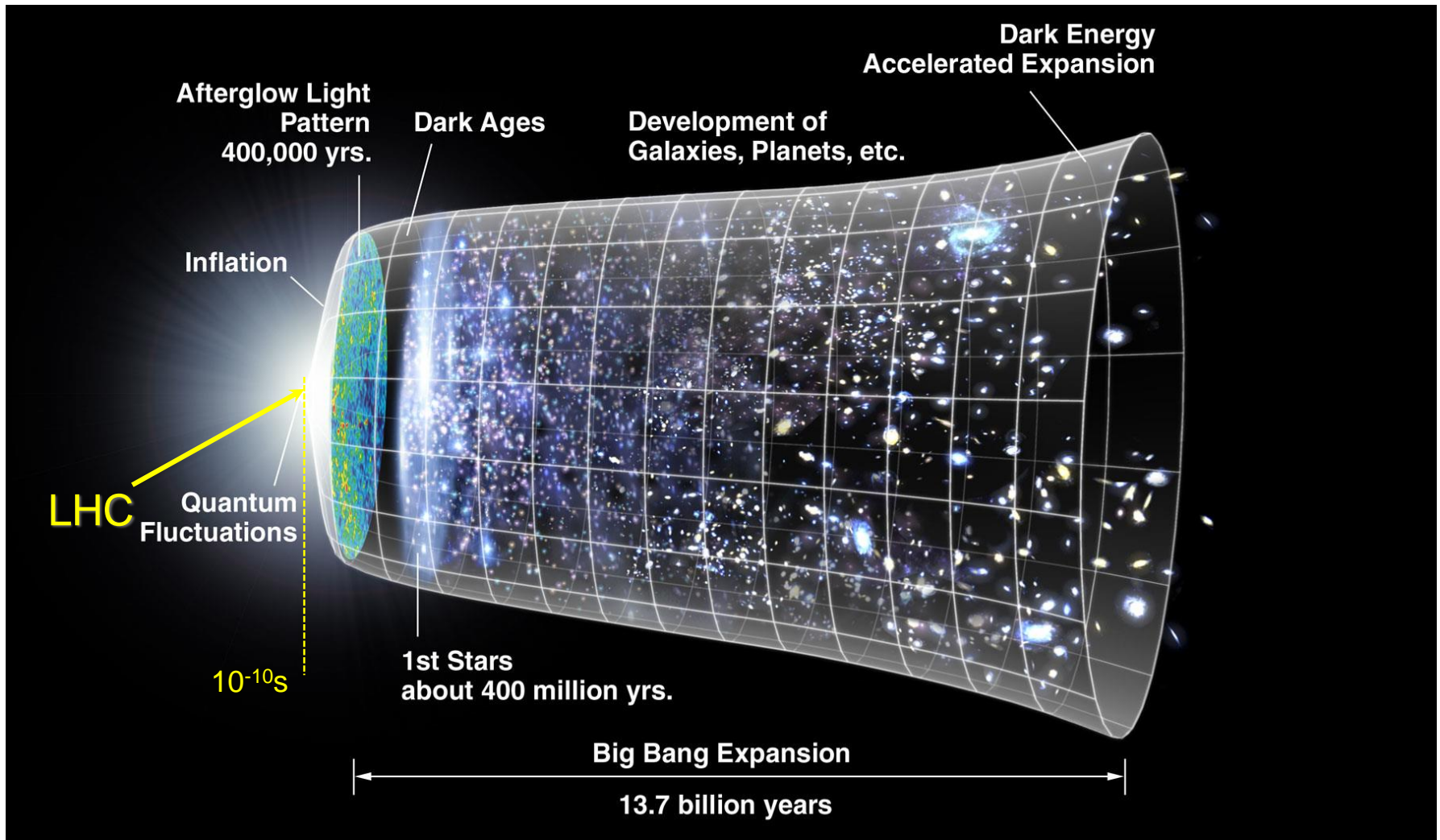

How are we doing
what we are doing?

The instruments use

1. Particle accelerator :

Boost particles to high energies and make them collide

2. Detectors :

Gigantic instruments that observe and record the results of the collisions

(particle trajectories, energy, charge...)

3. Computers :

Collect, store, and send around the world the big quantity of data received from the detectors for data analysis

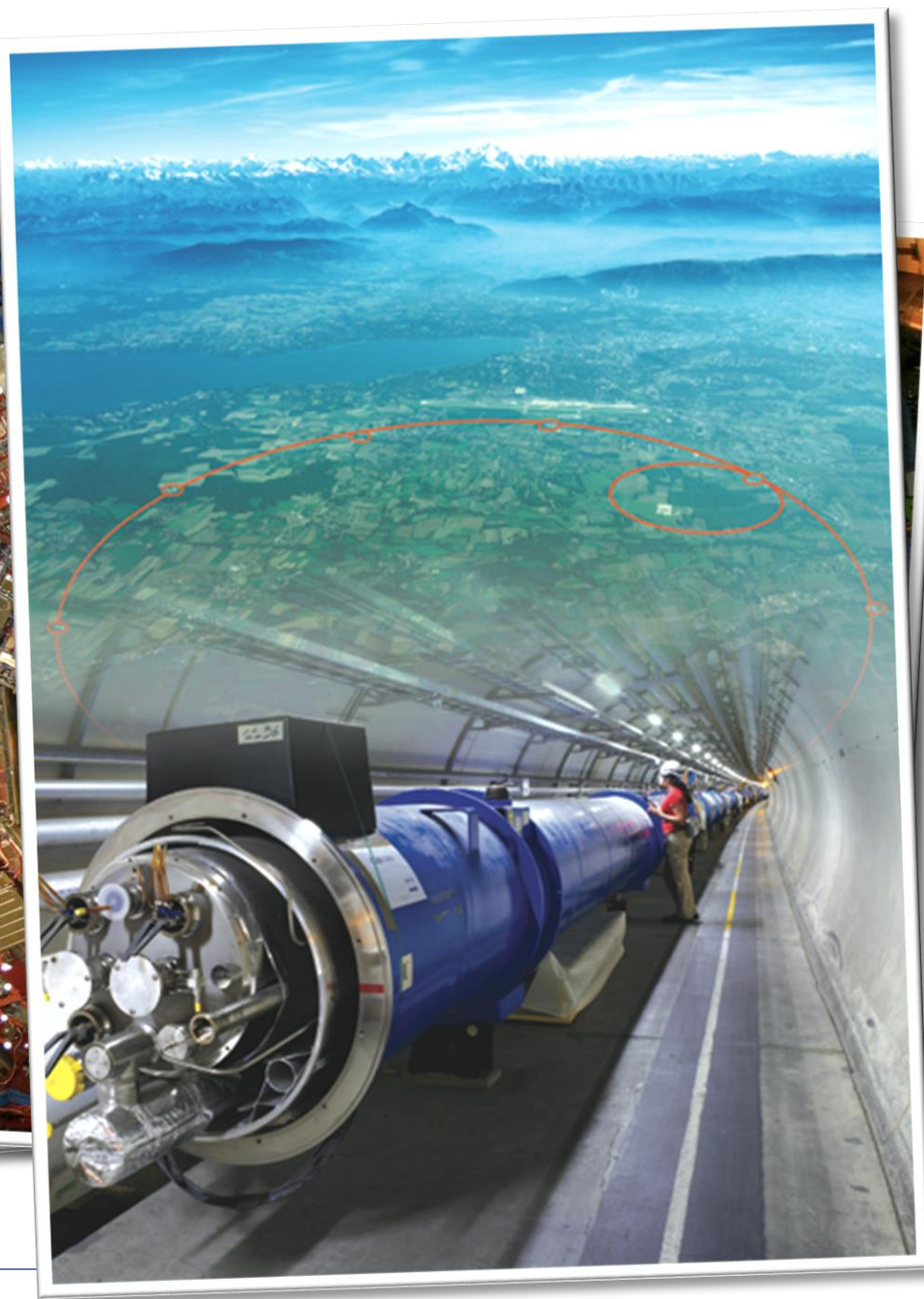

The technologies developed at CERN generate innovations

Accelerators

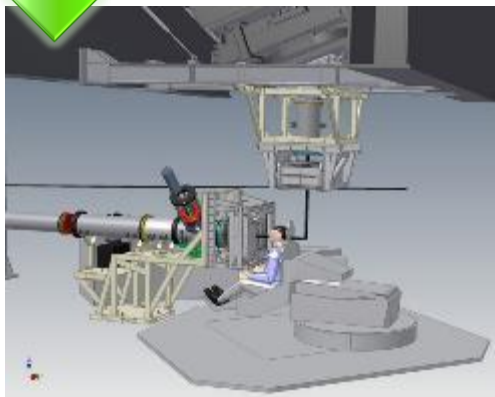
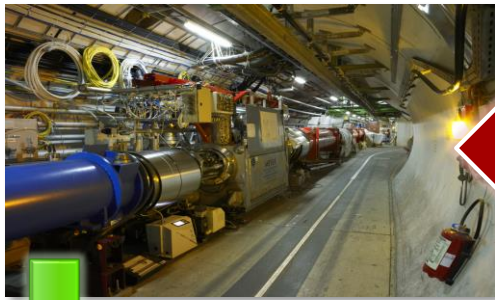

Hadron therapy

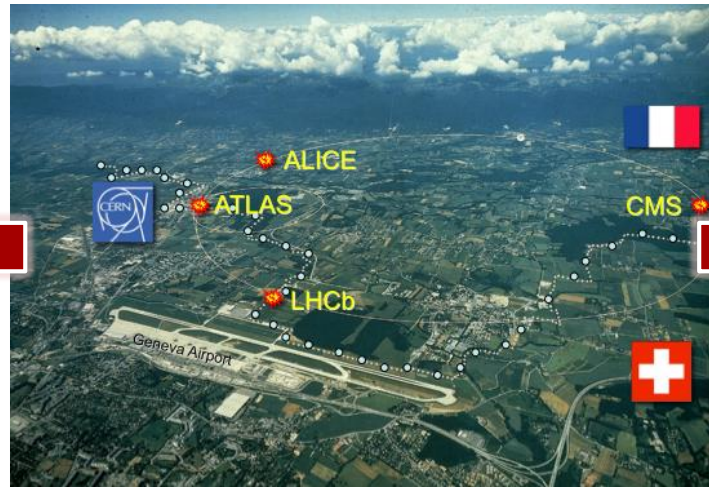

Detectors

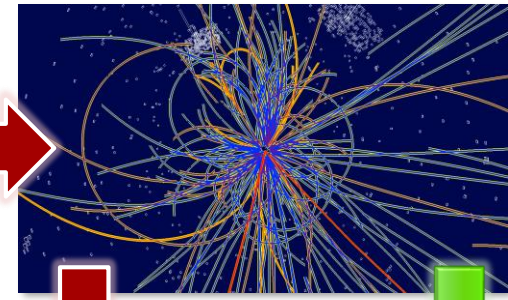

CAT

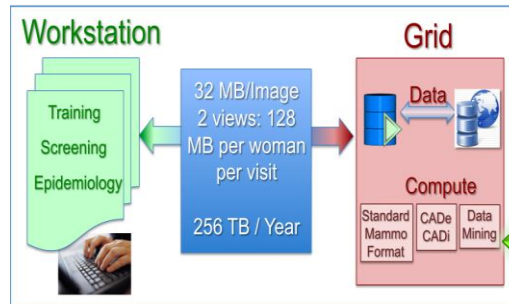

The Computing Grid

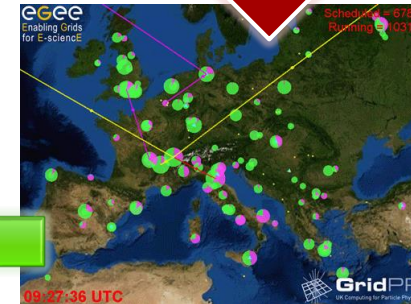

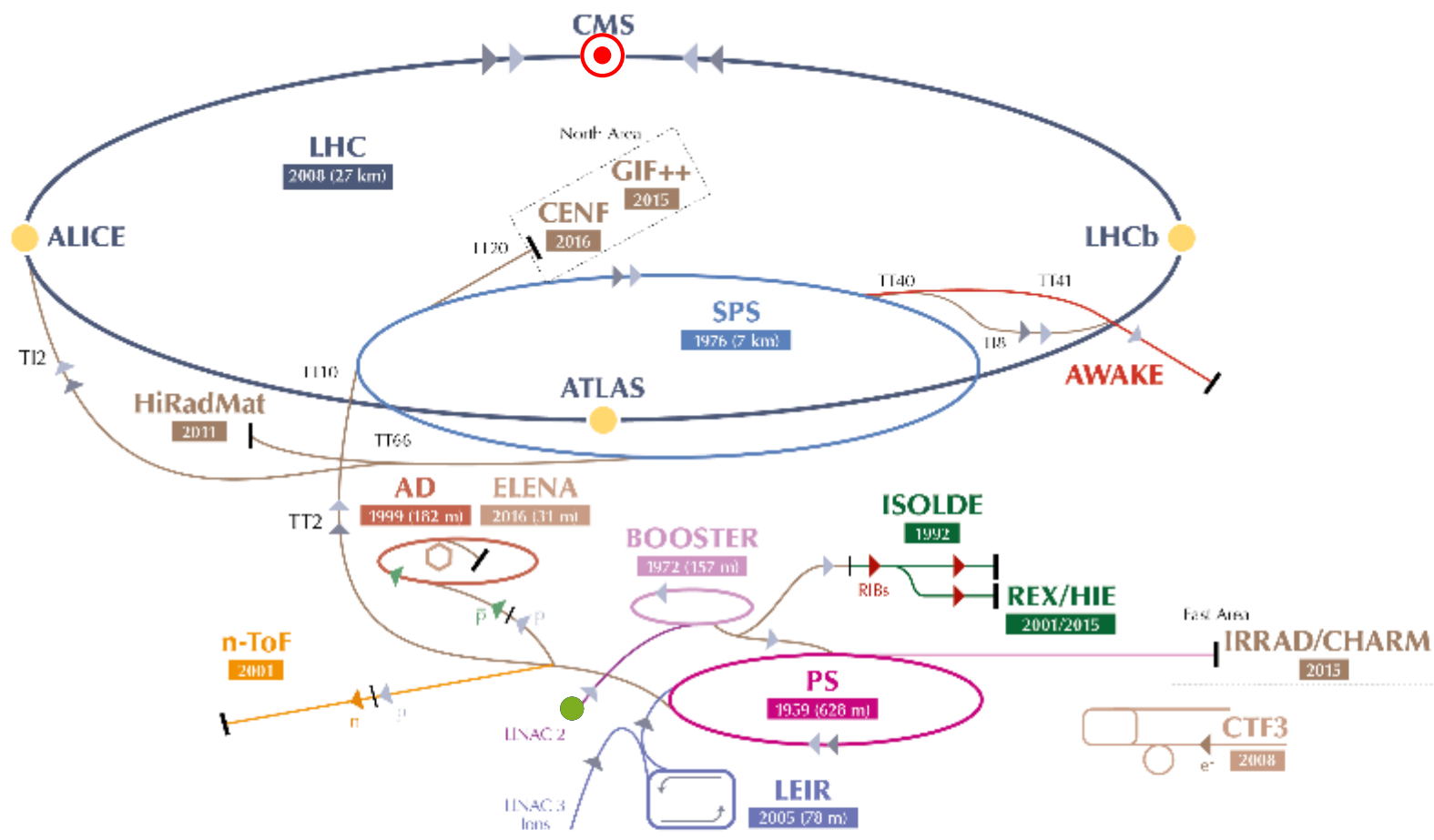

▶ p (protons) ▶ ions ▶ RIBs (Radioactive Ion Beams) ▶ n (neutrons) ▶ \bar{p} (antiprotons) ▶ e^- (electrons)

- LHC Large Hadron Collider SPS Super Proton Synchrotron PS Proton Synchrotron AD Antiproton Decelerator CTF3 Clic Test Facility
- AWAKE Advanced WAKEfield Experiment ISOLDE Isotope Separator OnLine REX/HIE Radioactive Experiment/High Intensity and energy ISOLDE
- LEIR Low Energy Ion Ring LINAC LINear ACcelerator n-ToF Neutrons Time Of Flight HiRadMat High-Radiation to Materials
- CHARM Cern High energy AccelErator Mixed field facility IRRAD proton IRRADiation facility GIF++ Gamma Irradiation Facility
- CENF CERN Neutrino platform

The LHC

A collider situated in an underground 27 km in an almost circular tunnel designed to accelerate two proton beams to 7 TeV

+ than 25 years

1982 : First studies

1994 : Project approved by the CERN council

1996 : Final decision and start of the construction

2004 : Installation starts

2006 : Hardware commissioning starts

2008 : End of hardware commissioning

2009-2030: Physics

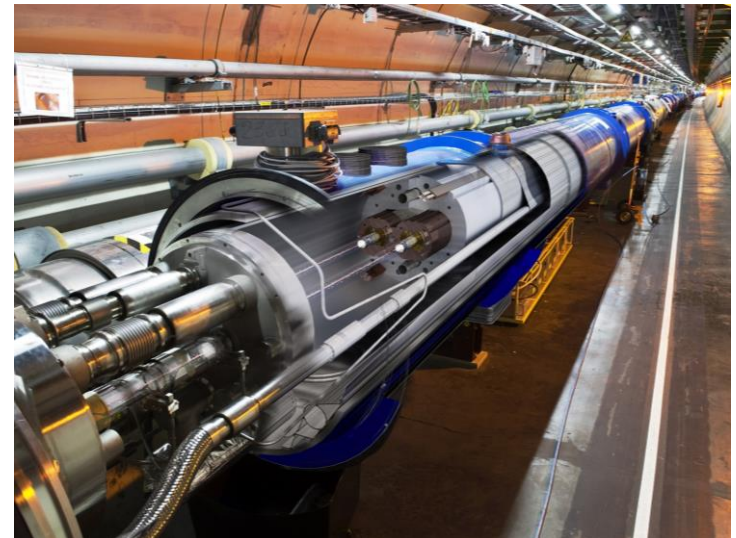
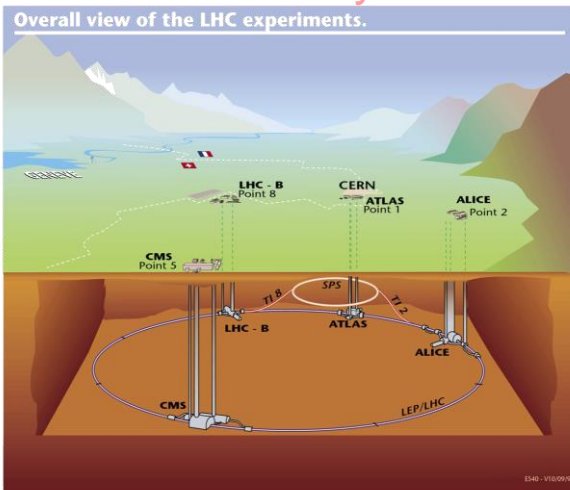

A big experiment at the LHC : ATLAS

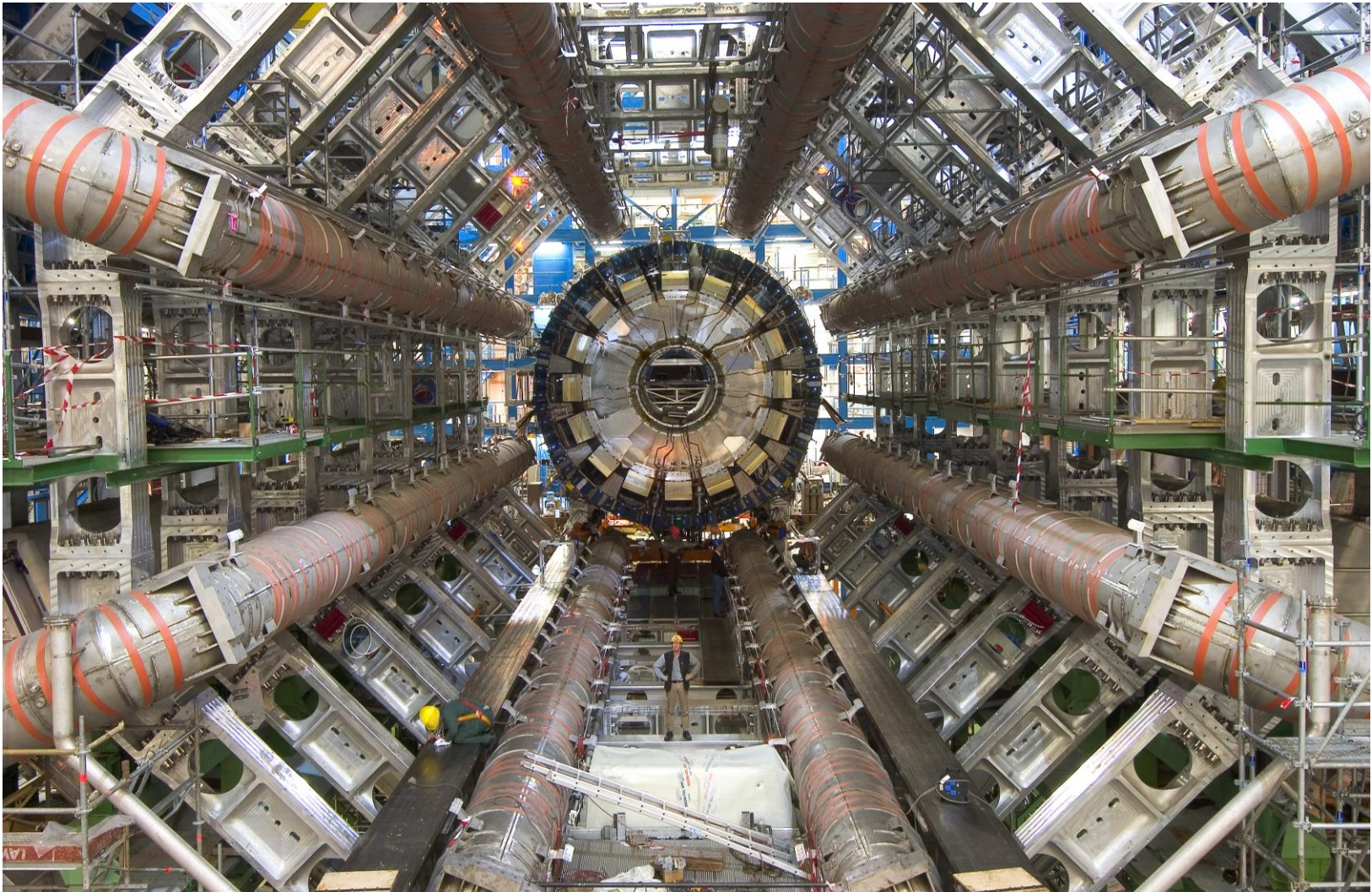

Taking pictures of particles: detectors

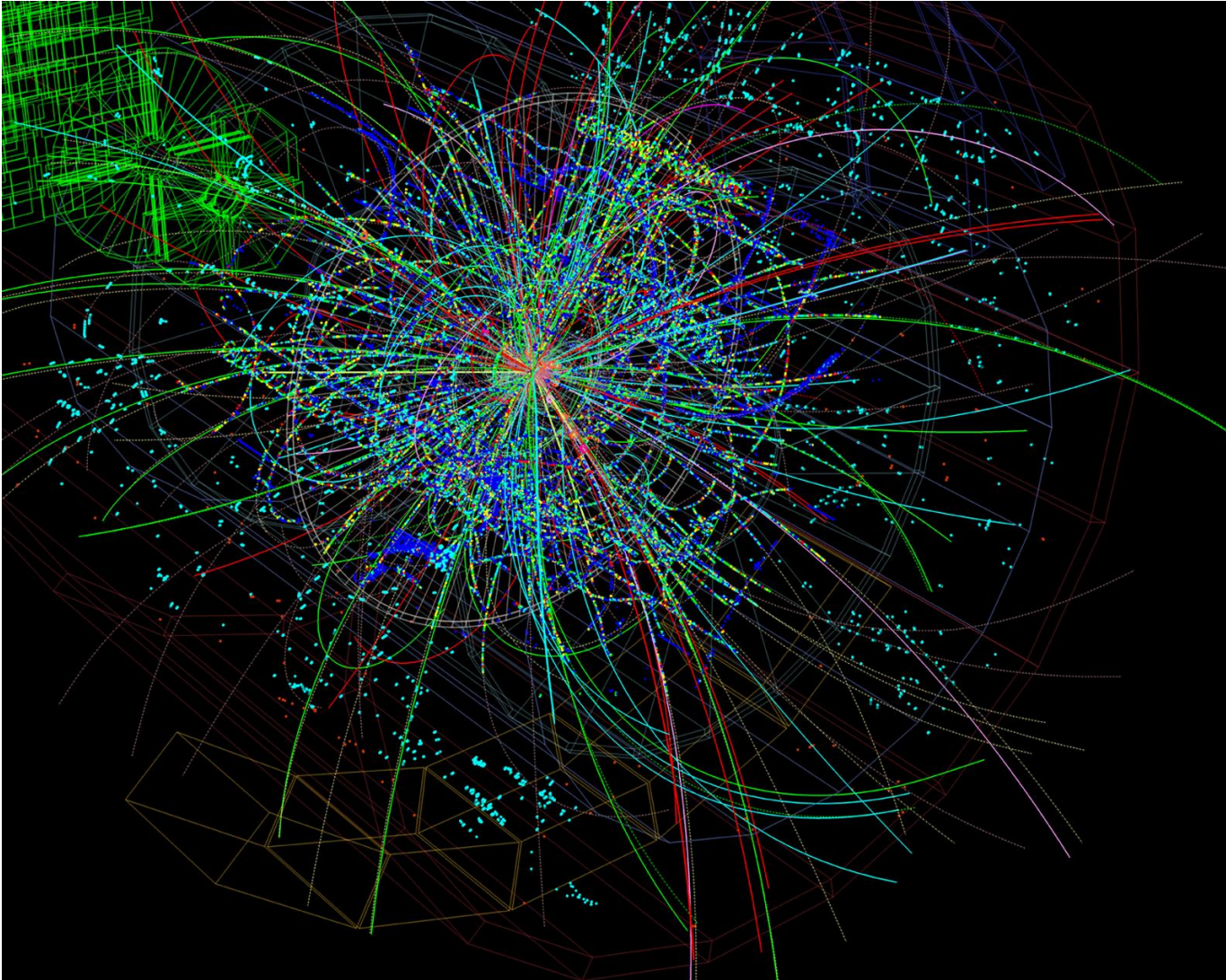

How do we study the elementary particles?

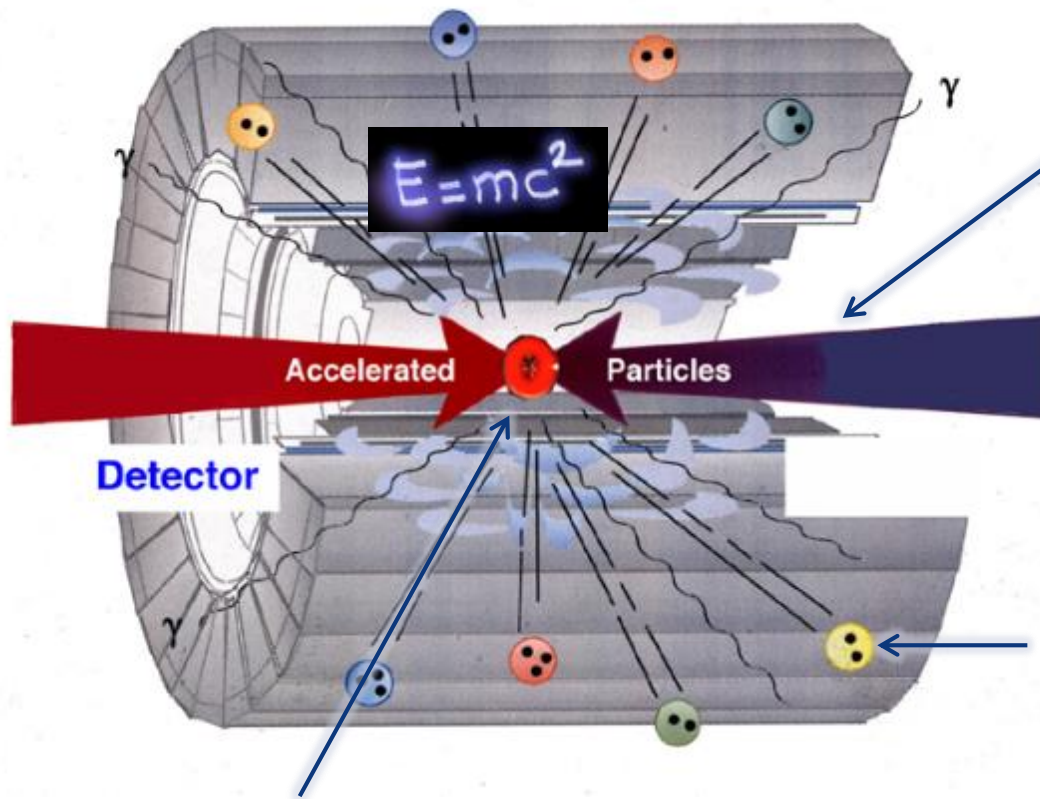

2) Collide these head-on

1) Accelerate protons or ions to high energy

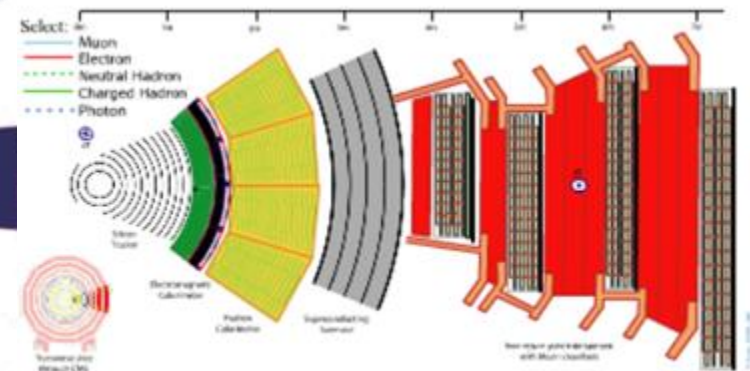

3 Identify the particles generated by the collisions

4) Collect and analyze the data from many collisions

$$H \rightarrow \gamma\gamma$$

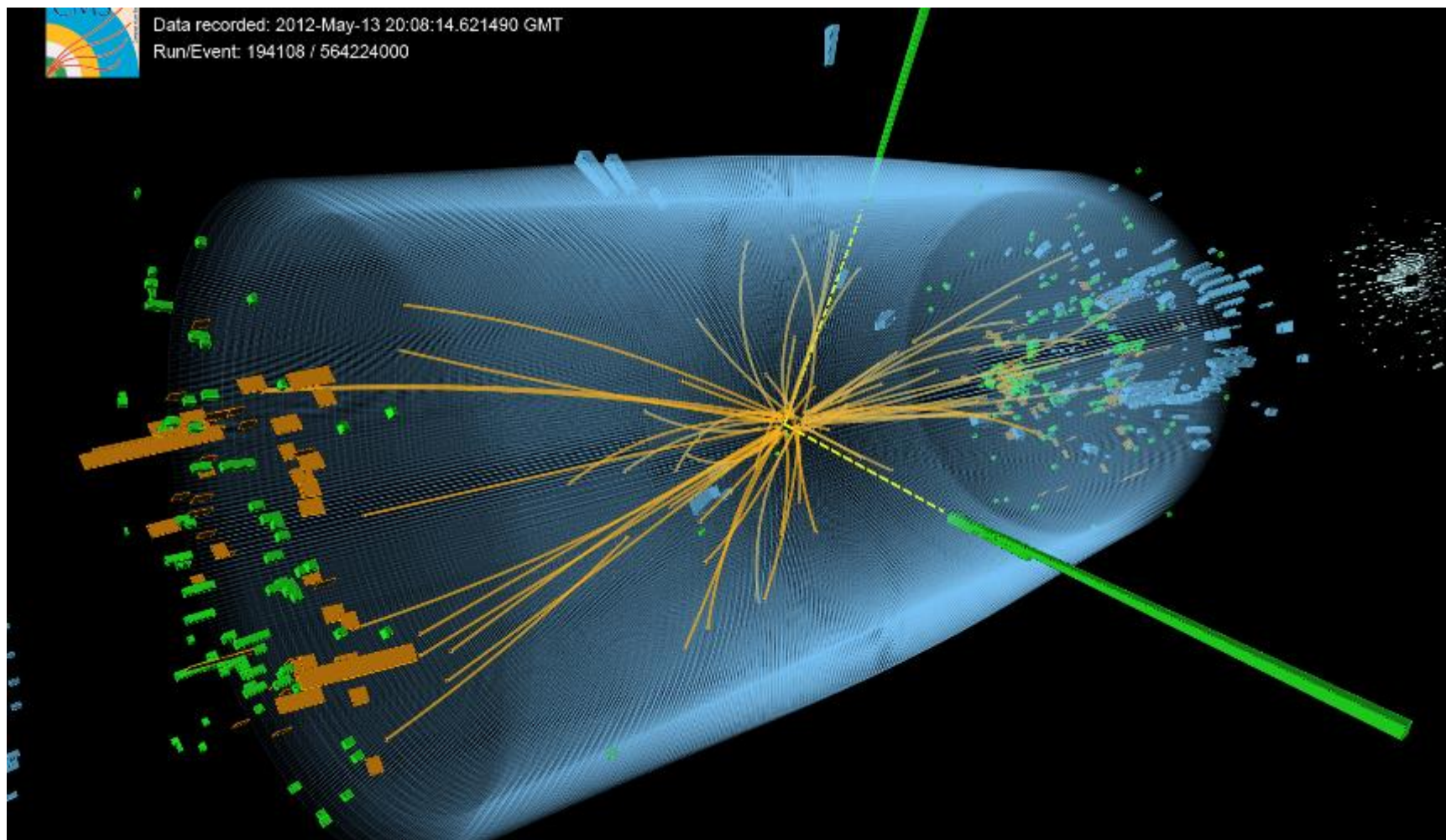

2012 : The year of the Higgs Boson

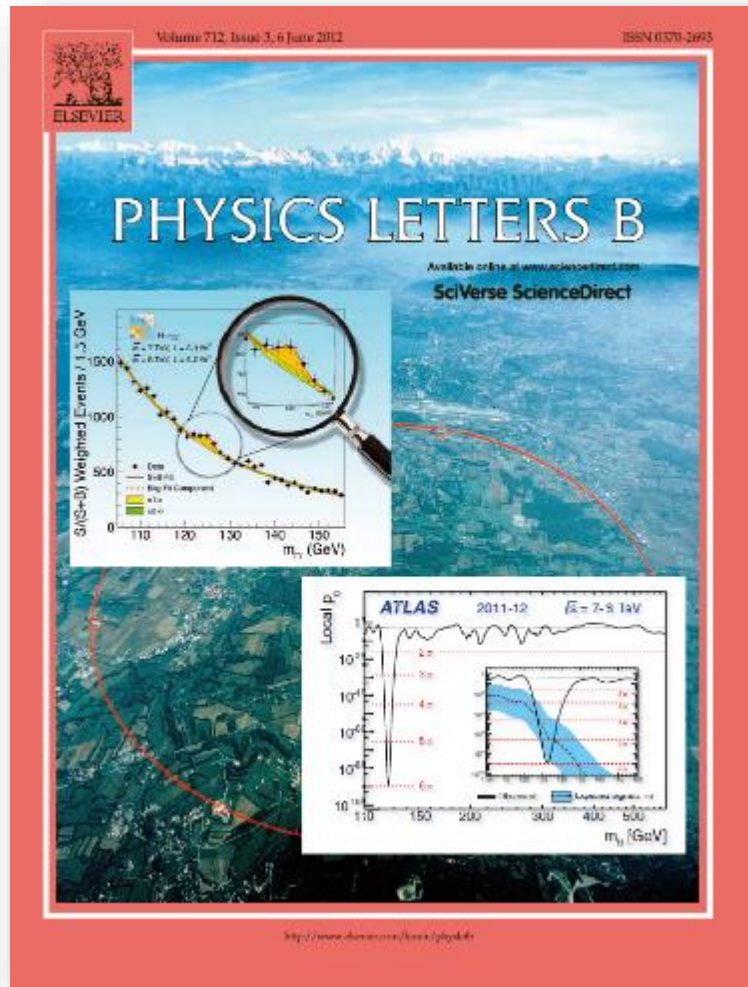

When will we be doing
what we are expected to do?

Who are we?

CERN Structure

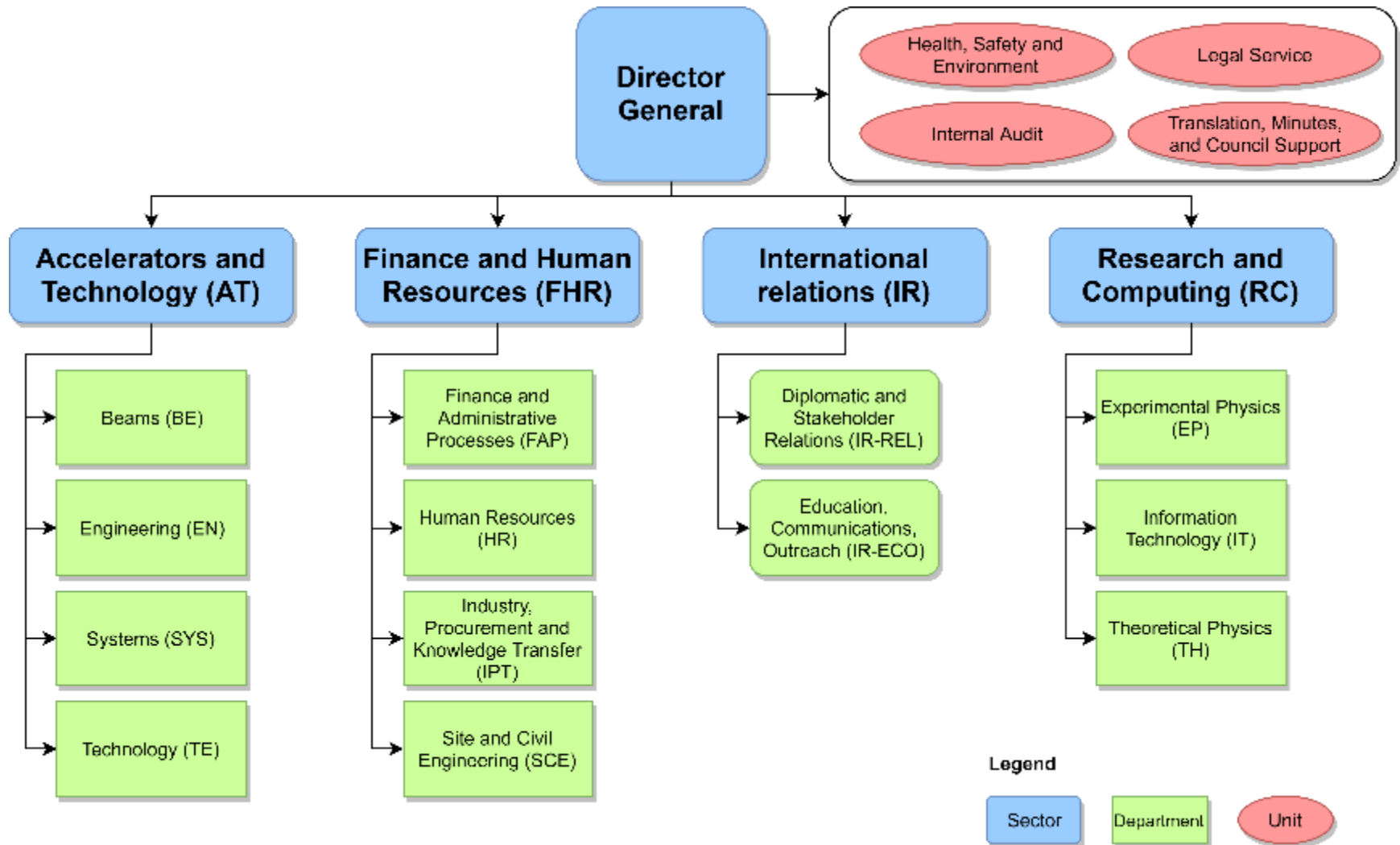

CERN Structure

Directorate

Director-General	Fabiola Gianotti
Director for Finance and Human Resources	Raphaël Bello
Director for Accelerators and Technology	Mike Lamont
Director for Research and Computing	Joachim Mnich
Director for International Relations	Charlotte Warakaulle



CERN Structure

Heads of departments

Accelerator Systems	Brennan Goddard
Beams	Rhodri Jones
Engineering	Katy Foraz
Experimental Physics	Manfred Krammer
Finance and Administrative Processes	Florian Sonnemann
Human Resources	James Purvis
Industry, Procurement and Knowledge Transfer	Christopher Hartley
Information Technology	Enrica Porcari
Site and Civil Engineering	Mar Capeans Garrido
Technology	José Miguel Jiménez
Theoretical Physics	Gian Francesco Giudice

Department Head: Katy Foraz

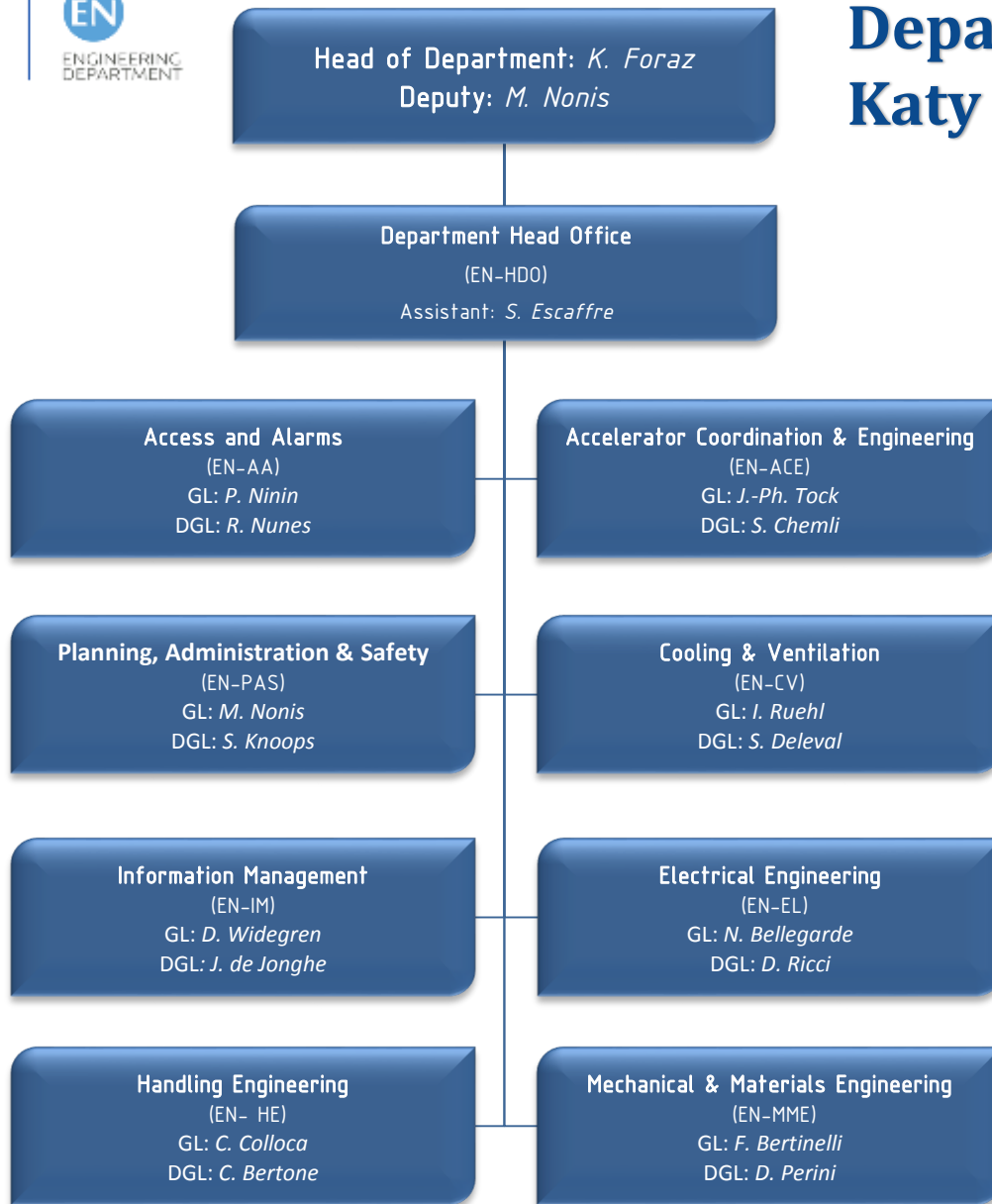

- Operation
 - Infrastructure
 - Accelerators
- Projects
 - Consolidation
 - Upgrades
 - New facilities
 - Design & Manufacturing
- Studies

Who are we in EN?

24 Nationalities

AT	BE	BG	BR	CH	DE	DK	ES	FI	FR	GB	GR	HU	IN	IT	NL	NO	PK	PL	PT	RO	RU	SE	SK
3	18	3	1	19	9	3	34	8	184	10	3	3	1	42	4	3	2	17	17	3	1	2	1

Professional Category

Administrative work	2	4%
Office & Administrative work	13	
Scientific & Engineering Work	182	47%
Scientific Work (Experimental & Theoretical Physics)	5	
Technical work	195	49%
Manual work, Crafts & Trades	1	

Status

Cooperation Associates	7
Doctoral Students	4
Fellows	37
Project Associates	17
Staff	320
Technical Students	6
Trainees	6
Administrative Student	1
TOTAL	398

Gender & Age

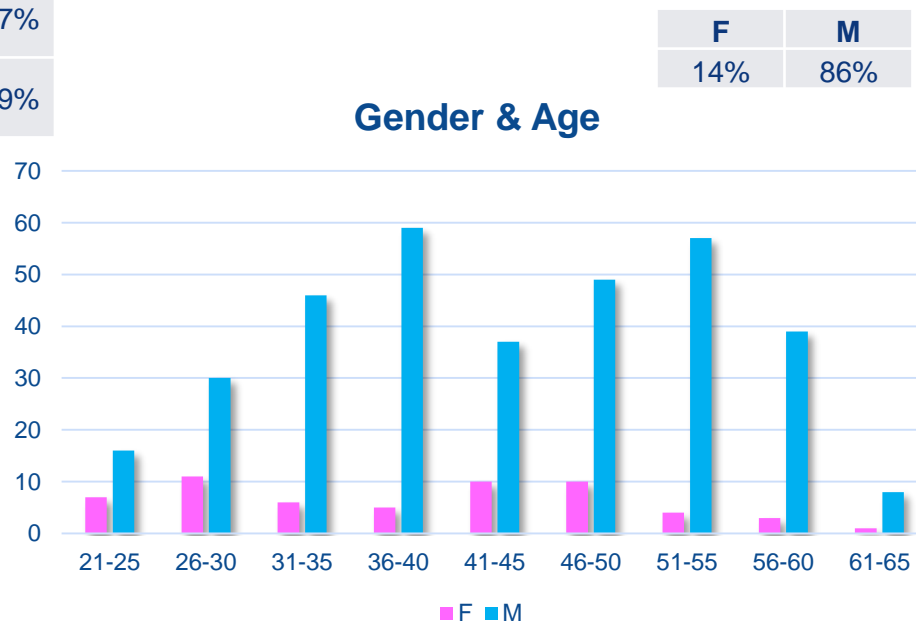

AA : Access and Alarms

The AA group is in charge of the specification, engineering, installation and maintenance of the systems that ensures the Safety of the CERN Personnel, Users and Visitors, on all its site and facilities.

The Safety Systems concerns:

- *Fire and Gas/ODH detection, emergency phones and evacuation, alarm transmission and monitoring,*
- *Interlocks to protect people radioactivity, X rays, lasers, electricity and cryogenics hazards,*
- *Access control to all CERN conventional or nuclear facilities and sites,*
- *Video surveillance, protection and intrusion detection,*
- *Access data management applications.*



Group Leader
Pierre Ninin

SPS-FIRE Safety Project: new automatic fire detection & fire protection

SPS-ACCESS Project: new access and safety system to the SPS underground areas

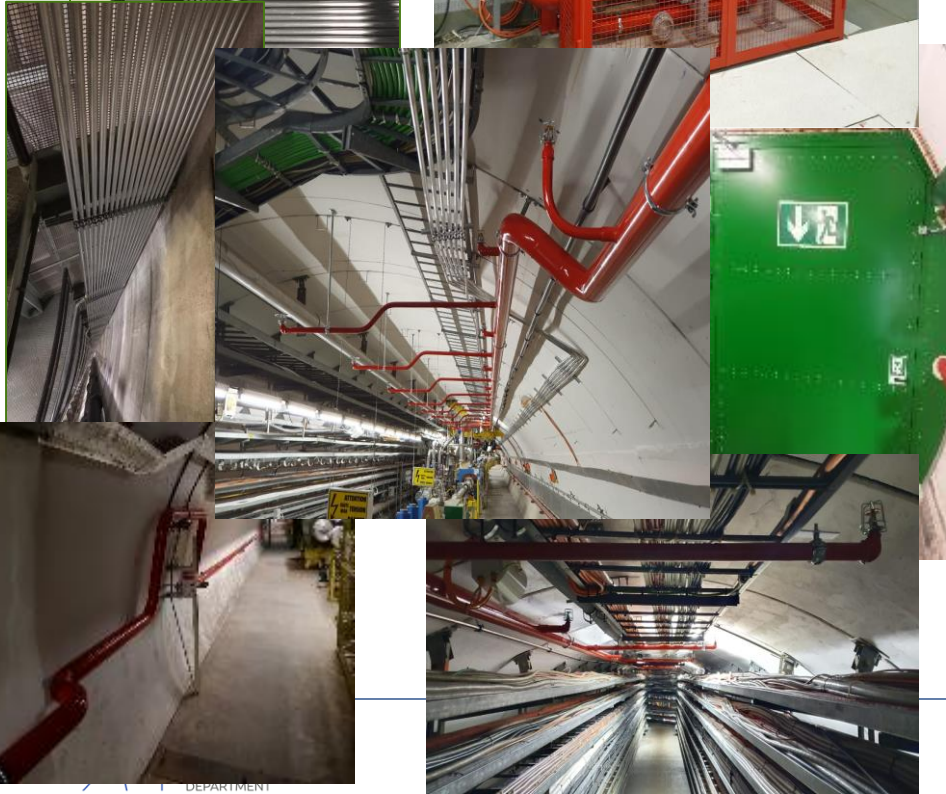

IM : Information Management

The IM group provides applications and support for engineering information management throughout the whole Organization and its different projects.

This includes for example mechanical CAD tools (such as CATIA), Product Lifecycle Management systems (Smarteam / Aras), the Engineering Data Management Service (EDMS) as well as the Enterprise Asset Management platform (Infor EAM).

The group helps implementing and configuring these tools according to user needs while ensuring that coherent processes are applied and provides user training.

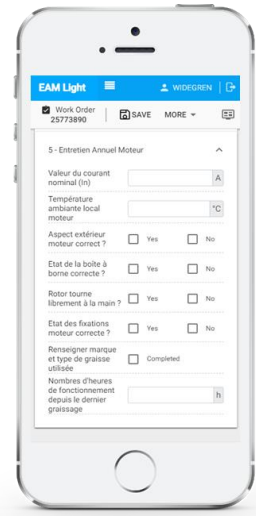
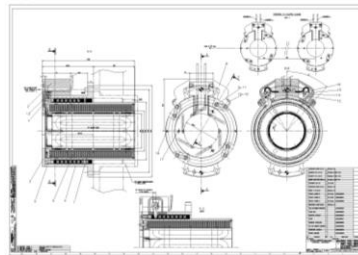
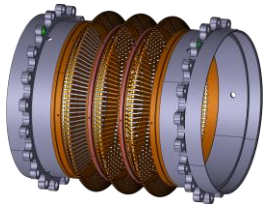

Group Leader
David Widegren

IM : Information Management

A key goal is to provide the tools required to manage and document the entire lifecycles of CERN's equipment and installations – also known as “Digital Thread”.

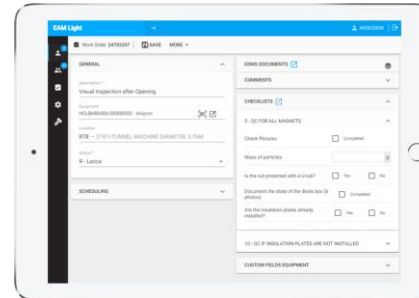
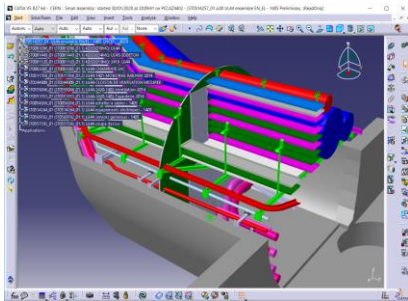
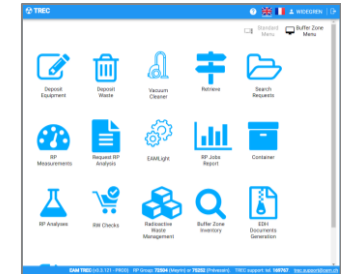
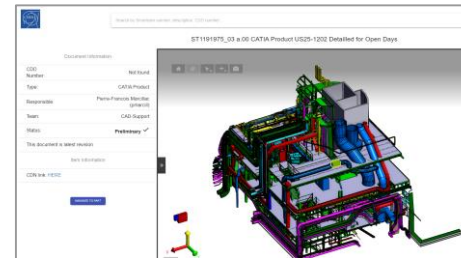
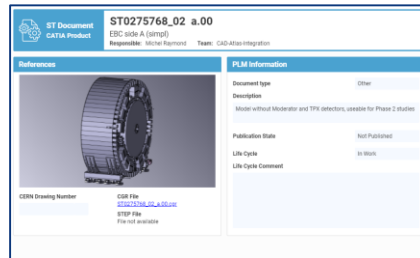
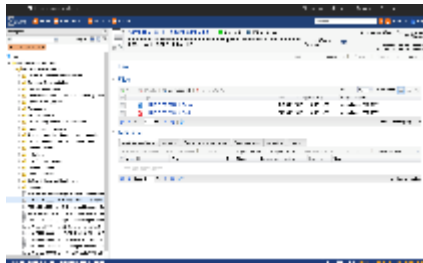

ACE : Accelerator Coordination & Engineering Group

The group coordinates the activities for the interventions and changes to the LHC and its injectors. This includes configuration & layout management, integration studies and maintenance of the related 3D-CAD representations, organization and scheduling of programmed stops, management of the mid- and long-term schedule, worksites follow-up and management of the LHC sites, management of electrical lock-out in LHC and operational safety coordination.

The group is responsible for the ATS Quality Service, giving support to the stakeholders of the ATS.

The group also provides support and/or advices in its key competencies.

Group Leader
Jean-Philippe Tock

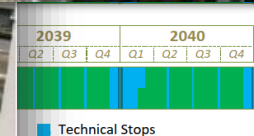
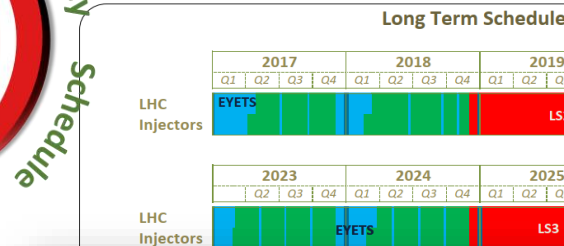

PAS : Planning, Administration and Safety

The group is responsible for supporting the Department Head in the management and planning of the department's **material and personnel resources**, as well as for all matters related to **safety and environment**. It represents the department in CERN-wide or inter-departmental bodies dealing with administrative, personnel, budget and safety matters. It also defines and implements safety and administrative procedures, for both the personnel and the material within the Department.



Group Leader
Mauro Nonis

People

	FORM NO. 2444911	REV. 0.1	VALIDITY DRAFT
CERN CH-211 Geneva 23 Switzerland			
Engineering Department			
Date: 2020-05-06			
REPORT			
EN Department Manpower Plan 2020-2025			
ABSTRACT: This document describes the EN Department Manpower Plan 2020. It was established following a bottom-up information gathering from EN group leaders and a top-down calibration during an EN Department retreat held 15 January 2020.			
DOCUMENT PREPARED BY: S. Kroops	DOCUMENT CHECKED BY: S. Legarde S. Bortone H. Brugger S. Caste S. Gabori M. Mas M. Nonis L. Ruffini L. Sesto	DOCUMENT TO BE APPROVED BY: R. Lofsto	

CV: Cooling and Ventilation Group

The group is in charge of:

- Design, installation, commissioning, operation and maintenance of the cooling systems, pumping stations, air conditioning plants and fluid distribution systems of all accelerators, their experimental areas and some of the special cooling systems of LHC sub-detectors.
- Computational fluid dynamics (CFD) simulations, as well as studies on fluid dynamics, ventilation, heat transfer, smoke behavior, gas and radio nuclides propagation are performed by the group.



Group Leader
Ingo Ruehl



Cooling

Cooling plants (raw, demin. water, C ₃ F ₈ , C ₆ F ₁₄)	150
Pipelines	800 km
Hydrants	800 points
Cooling towers (450 MW)	22
Chilled water plants 6-12 °C (73 MW)	35
Water consumption (peak)	1'260 m ³ /h
Water network (3 pumping stations)	5'400 m ³ /h



*Equivalent to a small town of 25'000 inhabitants.
Annual consumption reduced by 40% in last 8 yrs.*



Ventilation

Heating, ventilation and air conditioning	> 1'500 units from 2'000 to 120'000 m ³ /h each
Compressed air	14 stations 200 km network

	km	m ³ /h
<i>Eurotunnel</i>	50	540'000
LHC	27	290'000



EL : Electrical Engineering Group

The mandate concerns the **electrical distribution network** from 400 kV to 400/230 V. Its main missions are to operate, maintain, extend and renovate the network, analyse and make projections for CERN electrical energy consumption and manage relations with the energy suppliers.



Group Leader
Nicolas Bellegarde

Electricity Distribution

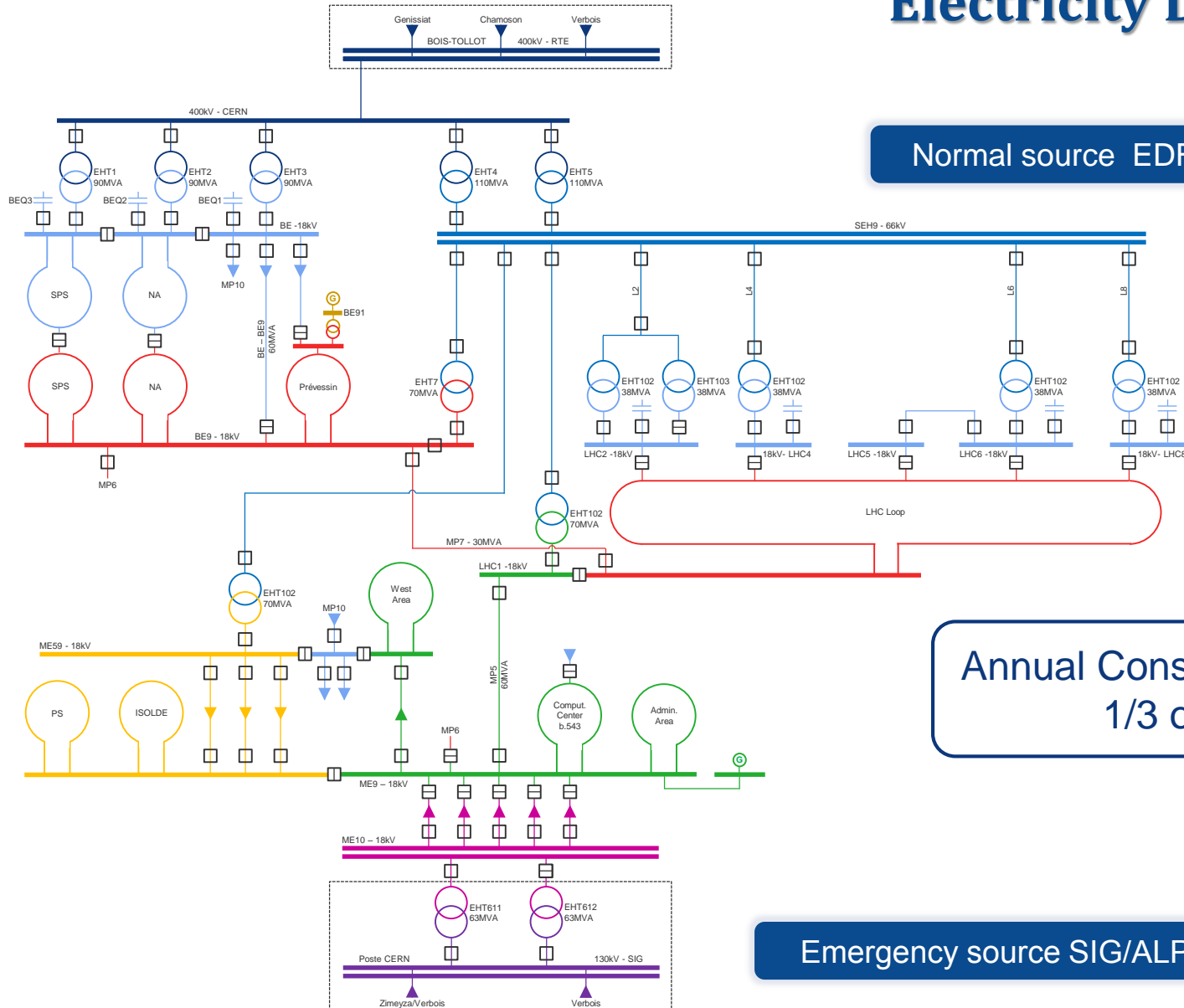

Normal source EDF > 200 MW

Annual Consumption 1.2 TWh
1/3 of Geneva

Emergency source SIG/ALPIQ ≤ 60 MW

EL : Electrical Engineering Group

The mandate also concerns the **cabling activities**. Its main missions are to install control cables, water cooled cables, and fibre optics for users. This activities include the management of infrastructures (cable trays, ducts, patch panels,etc.) and the necessary removal of old and unused installations.

EN-EL is also in charge of the controls of their distribution network.

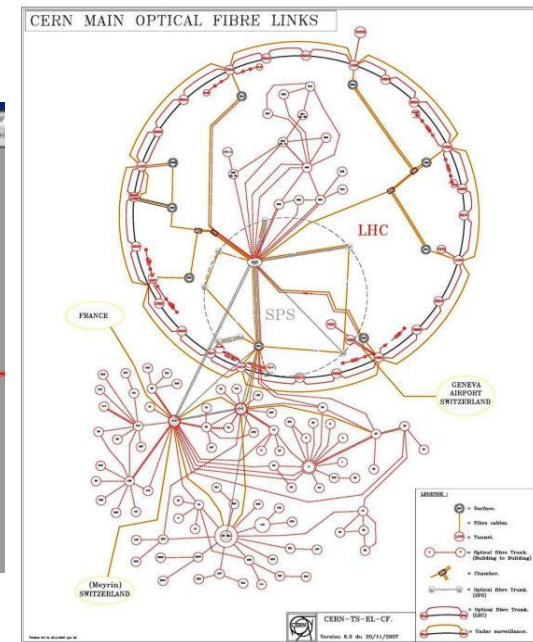
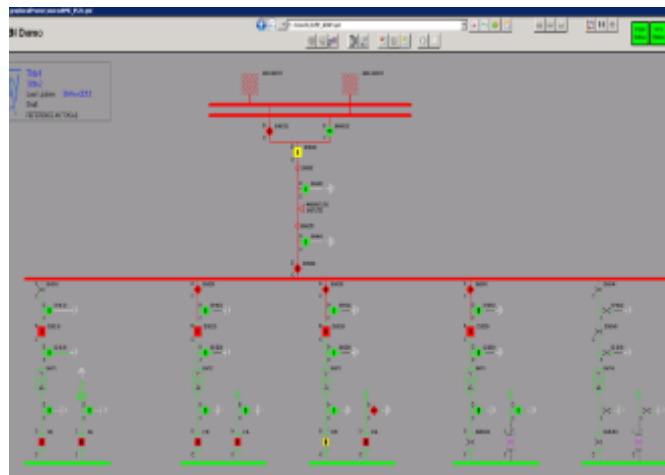

HE : Handling Engineering Group

From enormous pieces of equipment with unconventional shapes, to extremely delicate detector parts, the careful handling and transportation of components is essential at CERN.

The Handling Engineering (HE) Group prepares, organizes and coordinates all transport and handling operations for the CERN accelerators and experiments as well as the transport of thousands of conventional items, chemical and radioactive products per year.

The Group is specialized in the design, integration and feasibility studies related to the transport and handling operations. Both standard industrial and custom-built transport and handling equipment is being procured, installed and commissioned.

The Group manages and maintains all the industrial transport, handling and lifting equipment to ensure the perfect performance all along its lifecycle.

With the accelerator complex deep underground and about 700 buildings on surface, both passenger and goods lifts are very important. The HE Group is responsible for the purchase, installation and maintenance of all of them, regularly checking their performance.



Group Leader
Cristiana Colloca



HE : Handling Engineering Group

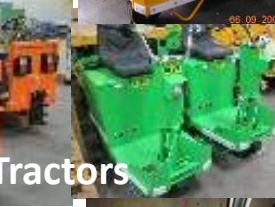

MME : Domains of activities

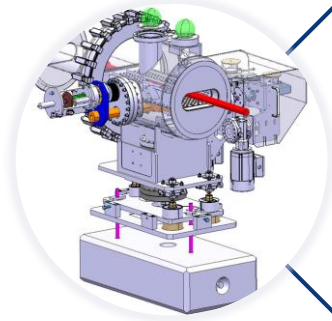

Design

- **Design Office**
 - 50+ designers and 15+ engineers
 - CATIA v5 / SmarTeam, ANSYS, LS-Dyna

- **Mechanical Measurements Lab.**

- **Mechanical workshop** (4000 m²)
 - 60+ technicians and 10+ engineers
 - CNC machining
 - Assembly & metal forming
 - Metal Additive Manufacturing
 - Welding (TIG, MIG, electron beam, laser, vacuum brazing)



Fabrication

- **Technical Subcontracting unit**

- **Material science consultancy**
 - metallurgical analyses, microscopy including FIB, mechanical tests
- **NDT:** UT, radiography, microtomography
- **Metrology:** 350 m² Lab., several CMM



Materials

What are our priorities?

Our priorities



SAFETY: What do we mean?

Occupational Health, Safety and Environmental protection

We mean...

- Put in place all possible measures to prevent:
 - Accidents
 - Illnesses
 - Impact to the environment

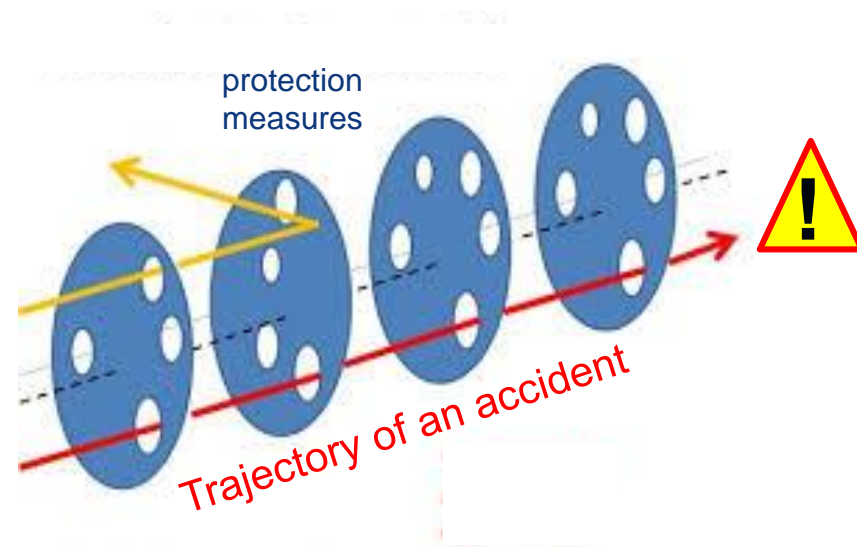

Reason Swiss Cheese Model

RESPONSIBILITIES

- The Director General takes appropriate measures to ensure safety of all participating in the activities of CERN or present in its site
- Each Member of Personnel shall actively contribute to the implementation of CERN Safety Policy through an exemplary conduct, in particular:
 - Comply with Safety Rules and Safety Objectives
 - Actively seek information to minimize risks
 - Avoid hazardous situations

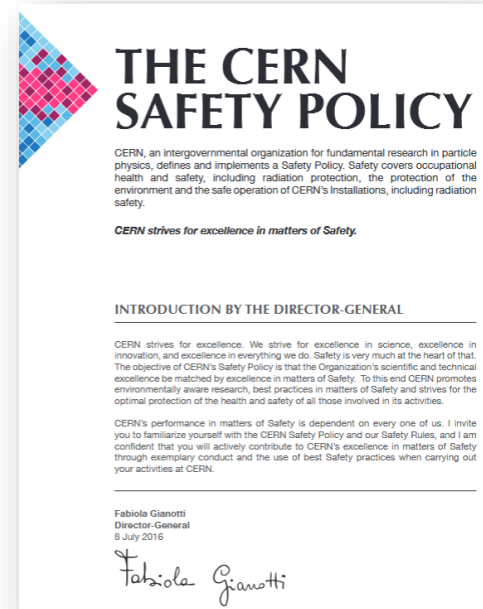

RESPONSIBILITIES in matters of safety **CANNOT BE DELEGATED**

MAGIC OF CERN

- Science is an extraordinary human endeavor
- Our understanding of nature at the fundamental level has reached astounding results
- The complexity of science requires a combined effort **technology + experiments + theory**
- CERN is a superb example of this combined effort at work

The scientific success of CERN belongs to all of us



ENGINEERING
DEPARTMENT

Warm welcome again!